



vespa

ricambi • spare parts



INDICE FASCICOLO VESPA

VESPA BOOKLET INDEX

Prodotti

Ammortizzatori **RUOTA IL CATALOGO**
e sfoglia il fascicolo dedicato





Alberi motore e bielle	353->372
Alberino ruota anteriore	279
Albero cambio	412+416
Anelli di tenuta (tabella riepilogativa)	375->378
Anellini OR	379
Assi ruota anteriore - asse ruota post. ricambi	279+411->412
Aste rubinetti benzina	447+449
Astucci a rulli	271->272
Attrezzo applicazione bordo scudo	303
Attrezzi monta/smonta rubinetti benzina	450
Bielle per albero motore	372
Bloccasterzo	324->325
Blocchetti on-off	328
Bobine accensione esterna	536
Bobine accensione interna	541
Bobine alimentazione	543
Bobine luci	542->543
Boccoli frizione	424+430
Bordi scudo	303->306
Braccio sospensione forcella	271->272
Cambio	409
Campane frizione	405+408+421
Calotte sterzo	275->274
Candela	502
Cappucci in gomma attacco candela	537
Carburatori e materiale inerente	458->467
Carta per guanizioni	394
Cavalletti centrali	468->472
Cavi candela	537
Cavi cambio, frizione, gas, starter	337->341
Centralina consenso avviamento	532
Centraline elettroniche	534->535
Cerchi ruota	281->282
Chiavette frizioni/volano	402
Chiavi candela	502
Chiavi smontaggio/rimontaggio rubinetto benz.	450
Cilindretti freno VESPA COSA	291
Clacson	313->314
Commutatori avviamento	544->545
Commutatori luci, lampeggiatori, frecce	551->554
Cornicette e trasparenti per kontakm.	316
Contatti,	538
Condensatori	538->540
Coperchi kontakm.	317
Coperchi manubrio	318->320
Coperchi molleggio	273->274
Coperchietti serrature	327
Coppie trasmissioni	410
Coperchi ventola	503->504
Coprimolleggio	273->274
Copri ruota di scorta	292
Cornici fanali anteriori	567->568

Pag. catalogo

Products

Page catalog

Air Conveyor	503->504
Air Filter	454
Axle for front wheel	279
Bearing ball track and spare parts	275->274
Bearings for crankshafts (complete list)	373
Bearings for front axle wheel	278
Bearings for rear axle wheel, cluster and gear shaft	433->434
Bellows	457
Bracket, mirror	321
Brake drum	284->286
Brake and clutch levers	443->445
Brake pads and shoes	287->290
Brake pump, cylinder VESPA COSA	291
Buffer for shock absorbers	498
Bulbs, light	555->564
Cable for spark plug attack	537
Cable for throttle, gear, clutch, brake	337->341
Carbone shock absorbers TURN CATALOG look at the dedicated booklet	 
Carburetors and spare parts	458->467
Cap for drum, cap for fuel tank	283+453
Central Stand	468->472
Chassis door	507->508
Cleaner air	454
Clips	307
Cluster gear + pins	425
Clutch	402->434
Clutch assy	403+404+407+427->429
Clutch backplates	424+430
Clutch drums	405+408+421
Clutch discs set	403+404+407+408+419+420+430->432
Clutch gears	423+430
Clutch pressure plate set	406+408+422
Clutch springs	405+407+421
Clutch & brake lever->	443->445
Clutch & flywheel extractor	435
Clutch & flywheel keys	402
Cylinder head, cylinder studs	349+351
Coils H.T. external, H.T. internal, lights	536+543
Con-rods	372
Contacts point, Condensers	538->540
Conveyor air fan cover	503->504
Cooling hood	505->506
Covers fan	503->504
Covers fork	273->274
Covers for spare wheels	292
Covers for front steering	308->312
Covers for handlebar	318->320
Crankcase screws	351->352
Cranks pedal start	344->346
Crankshafts and con-rod	353->372
Crankshafts bearings	373
Crankshaft revision kit	380->392
Crest for mudguards and headlights	293->294



INDICE FASCICOLO VESPA

VESPA BOOKLET INDEX

Prodotti	Pag.catalogo	Products	Page catalog
Cornici fanali anteriori «SIEM»	589->592	Cush gear set	411+426
Cornici targa	301	Dellorto Carburetors and spare parts	458->467
Corone parastrappi	426	Device, blinker	532
Creste parafanghi e faro anteriore	293->294	Discs, clutch	419+420+430->432
Crociera innesto marce, cambio	414->415	Drive pinions	336
Cuffia raffreddamento cilindro	505->506	Drive shaft	412+416
Cuscinetti a sfera albero motore	373	Drums	284->286
Cuscinetti albero primario, albero ruota ...	433->435	Drum plugs	283
Cuscinetti asse ruota anteriore	278	Electrical equipment wires	547->550
Cuscinetti asse ruota posteriore / cambio	433->434	Electrical spare parts	525->554
Dadi frizione, volano	402	Electrical starter motor	530->531
Dadi ruota, tamburo	280	Emblems	513->524
Dellorto Carburatori e ricambi	458->467	Engine doors	507->508
Depuratori aria	454	Engine elastic buffer	352
Dischi frizione	403+404+407+408+ 419+420+430->432	Engine gaskets	394->400
Estrattore/ricollocatore per forcella	269	Extractor for clutch and flywheel	435
Estrattori volano e frizione	435	Extractor for front fork	269
Fanaleria	565->612	Fan covers	503->504
Fanaleria «SIEM»	578->611	Floor board	473->475
Fanali posteriori	569->572	Flywheel fan	530
Fanali posteriori «SIEM»	593->607	Footboard (plastic)	494
Fondi pedana in lamiera grezza >	473->475	Footboard strips	476->487
Forcelle e ricambi	269->272	Footboard strips profile	488
Frecce anteriori/post	573->576	Footboard strips terminal pads	489->490
Frecce anteriori/posteriori SIEM	608->612	Fork and spare parts	269->272
Frizione	402->434	Fork covers	273->274
Gabbie spinotto biella	372	Fork pins	277
Gabbie per serie calotte sterzo	276	Fuel cocks, fuel cocks rods	447->449
Ganasce freno	287->289	Fuel cocks, remove and replace key	450
Ganci porta borsa	510	Fuel tank	450->451
Ganci ritegno cofani	508	Fuel tank cup	453
Generatori di corrente	532	Gaskets for fuel tank	450+452
Getti carburatore	463->464	Gaskets for headlights and taillights	577
Ghiere arresto cuscinetto ruota	278	Gaskets horn	315
Gomma per serie strisce pedana	488	Gaskets paper	394
Gommini passacavo	495	Gaskets set for carburetor	467
Gommini protezione leva freno	499	Gaskets set for engine	395->400
Guaina	342->343	Gears set	410
Guarnizioni carburatore	467	Gear shift sleeve	436->438
Guarnizioni clacson	315	Gear speed	409+418
Guarnizioni cofani, bauletto	509	Gear starter	347
Guarnizioni fanali anteriori, posteriori	577	Grips	441->442
Guarnizioni motore	394->400	Hand cylinder	349
Guarnizioni scarico	350	Handlebar covers	318->320
Guarnizioni serbatoio benzina	401+450+452	Handlebar cables guide plates	344+438
Guarnizioni tappo serbatoio	453	Headlights	565->566
Gruppi frizioni	403+404+407+427->429	Headlights «SIEM»	578->587
Gruppi ottici	565->566	Headlights bulb socket «SIEM»	588
Gruppi ottici «SIEM»	578->587	Headlights RIM	567->568
Impianti elettrici	547->550	Headlights RIM «SIEM»	589->592
Ingranaggi avviamento	347	Hoods and mudguard trim	302
Ingranaggi rinvio contakm.	336	Hook for bags	510
Ingranaggi frizione	423+430	Hooks retailer	508
Ingranaggi multipli	425	Horns, horn gaskets	313->315
Ingranaggi parastrappi	426	H.T. external coils, internal,	536+541
		H.T. outer coils	543

INDICE FASCICOLO VESPA

VESPA BOOKLET INDEX

Prodotti

Ingranaggi di velocità	409+418
Interruttori stop	545
Interruttori luci-avviamento-freccce	551->554

Kit ammortizzatori **RUOTA IL CATALOGO**
e sfoglia il fascicolo dedicato



Kit cornice+trasparente per contakm.	316
Kit fregi cofani-parafanghi	302
Kit revisione albero motore	380->392
Kit scodellino per asse ruota	412
Kit trasmissioni x restauro	342

Lamierati	473->475
Lampadine	555->564
Leve freno - frizione	443->445
Listelli per tappetini centrali	493

Manicotti aspirazione	457
-----------------------	-----

Manopole	441->442
----------	----------

Mascherine copristerzo	308->312
------------------------	----------

Materiale elettrico	525->554
---------------------	----------

Molle cavalletto	472
------------------	-----

Molle frizione	405+407+421
----------------	-------------

Molle ganasce freno	291
---------------------	-----

Motorino avviamento e parti inerenti	530->531
--------------------------------------	----------

Parafanghi e protezioni	295->300
-------------------------	----------

Paraoli motore (tabella riepilogativa)	375->379
--	----------

Paraoli asse ruota anteriori	279
------------------------------	-----

Parti in gomma	495->501
----------------	----------

Pastiglie freno	289->290
-----------------	----------

Pedane appoggiapiedi in plastica	494
----------------------------------	-----

Pedane (fondi in lamiera grezza)	473->475
----------------------------------	----------

Pedivelle avviamento	344->346
----------------------	----------

Perni ingranaggio multiplo	425
----------------------------	-----

Perni sospensione forcella	277
----------------------------	-----

Piattelli frizione	406+408+422
--------------------	-------------

Piastre guida fili manubrio	344+438
-----------------------------	---------

Piastrine fissa cavalletto	472
----------------------------	-----

Piastrine per viti autofilettanti	307
-----------------------------------	-----

Piedini cavalletto	471
--------------------	-----

Pompa freno VESPA COSA	291
------------------------	-----

Porta lampada SIEM	588
--------------------	-----

Porta targa	301
-------------	-----

Porta oggetti, sopra il bauletto	305
----------------------------------	-----

Prese bassa tensione	546
----------------------	-----

Preselettori cambio	417
---------------------	-----

Prigionieri cilindro	351
----------------------	-----

Profilo per serie strisce pedana	488
----------------------------------	-----

Protezioni scocca posteriore	299->300
------------------------------	----------

Puntalini per sr.strisce pedana	489->490
---------------------------------	----------

Raccordi aspirazione	455->456
----------------------	----------

Raccordi scarico	350
------------------	-----

Raddrizzatore di corrente	534
---------------------------	-----

Regolatori di tensione	533
------------------------	-----

Ribattini x restauro	512
----------------------	-----

Ribattini x sr. strisce pedana	491
--------------------------------	-----

Ricambi elettrici	525->554
-------------------	----------

Pag.catalogo

Products

Ignition systems	534->535
Indicator direction switches	553->554
Indicator lenses, indicator lenses SIEM	573->576+608->612

Key, clutch and flywheel	402
--------------------------	-----

Key, remove and replace fuel cock	450
-----------------------------------	-----

Kick start lever	344->346
------------------	----------

Kit revision for crankshaft	380->392
-----------------------------	----------

Kit shock absorbers **TURN CATALOG**
look at the dedicated booklet

Jets, carburetor	463->464
------------------	----------

Levers, clutch and brake, lever screws	443->446
--	----------

Light coils	542->543
-------------	----------

Light switches	544+551->554
----------------	--------------

L.T. socket assy	546
------------------	-----

Mat retainer strips	493
---------------------	-----

Master cylinder VESPA COSA	289
----------------------------	-----

Mirrors, mirror brackets	318->321
--------------------------	----------

Mudguard and protections	295->300
--------------------------	----------

Mudguard crests	293->294
-----------------	----------

Nameplates	513->524
------------	----------

Needles, carburetor	462
---------------------	-----

Nut for clutch, flywheel	402
--------------------------	-----

Nut for drum, wheel	280
---------------------	-----

Oil seals	374->392
-----------	----------

Oil seals for front wheel axle	279
--------------------------------	-----

Oil tank	453
----------	-----

Outer H.T.	543
------------	-----

Pads brake	289->290
------------	----------

Pads for central stand	471
------------------------	-----

Pedal crank starter	344->346
---------------------	----------

Pick-up	532
---------	-----

Pins, cluster gear	425
--------------------	-----

Pins fork	277
-----------	-----

Plates, handlebar cables guide	344+438
--------------------------------	---------

Plug flywheel	496
---------------	-----

Plugs for drum	283
----------------	-----

Rear protections	299->300
------------------	----------

Remote control switch	532
-----------------------	-----

Revision kit for crankshaft	380->392
-----------------------------	----------

Rim for headlighth	567->568
--------------------	----------

Rims for headlighth «SIEM»	589->592
----------------------------	----------

Rims, wheel	281->282
-------------	----------

Ring to fix wheel bearing	278
---------------------------	-----

Rivets for footboard strips, rivets for restyling	491+512
---	---------

Roller cage	372
-------------	-----

Rubber profile, footboard strips	488
----------------------------------	-----

Rubber profile, sidepanels, toolbox, cowls and hoods	509
--	-----

Rubber for brake lever	291
------------------------	-----

Rubber mat, rubber parts	492->501
--------------------------	----------

Saddle lock	332
-------------	-----

Screws for brake and clutch lever	446
-----------------------------------	-----

Screws for crankcase	351->352
----------------------	----------

Screws for fixing mudguards	298
-----------------------------	-----

Screws for load/unload for engine oil	393
---------------------------------------	-----

Screws for wheels	280
-------------------	-----



INDICE FASCICOLO VESPA

VESPA BOOKLET INDEX

Prodotti	Pag.catalogo	Products	Page catalog
Rondelle per leve freno/friz.	446	Security lock	324->332
Rondelle per serie calotte sterzo	276	Selector gear, selector spindle	413->417
Rubinetti benzina	447->449	Set gaskets for engine	395->398
Scatole porta attrezzi	511	Set oil seal	383->392
Serbatoio benzina	450->451	Sheat	342->343
Serbatoio olio	453	Shield beading	303->306
Settori avviamento	348	Shift sleeve for gear-throttle	436->440
Serie calotte sterzo	275->276	Shock absorbers TURN CATALOG	
Serie dischi frizione	419+420+430->432	<i>look at the dedicated booklet</i>	
Serie guarnizioni motore	395->398	Shoes, brake	287->289
Serie paraoli motore (tabella riepilogativa)	374	Sleeve	457
Serie paraoli motore	383->392	Side panel for engine	507->508
Serie parastrappi	411+426	Spare wheel bracket	292
Serie strisce pedana	476->487	Spare parts fork	271->272
Serrature	324->332	Spark plug and spark plug tools	502
Serrature sella	332	Spark plug cup, spark plug cables	537
Scudetti	517->518	Speedometer rims set	316
Specchi cromati universali	322->323	Speedometer transmission and drive pinion	333->336
Spilli carburatore	462	Springs brake shoes	291
Sportelli motore	507->508	Stand pads (pair) and spare parts	471->472
Sportello bauletto	305	Stators	525->529
Staffe supporto specchi	321	Starter gears	347
Statori	525->529	Starter motor and spare parts	530->531
Steli comando cambio	416	Starter pedal cranks	344->346
Supporti motore	352	Starter sector	348
Supporti ruota di scorta	292	Starter tie-rod	448
Tamburi freno	284->286	Steering covers	308->312
Tamponi elastici lato motore	352	Stud for sec.cylinder	351
Tamponi per ammortizzatori	498	Switches ON-OFF	328
Tamponi riscontro settori avviamento	349	Switches starter, lights, stop	544->554
Tappeti centrali	492->494	Suspension pins	279
Tappi scatola depuratore	454	Taillights	569->572
Tappi serbatoio	453	Taillights SIEM	593->607
Tappi tamburo	283	Taillight gaskets	577
Targhette	513->524	Tank fuel, tank oil	401+450+451+453
Tasselli feritoia volano	496	Terminal pads for footboard strips	489->490
Teleruttori avviamento	532	Throttle shift sleeve	439->440
Teste cilindro	349	Tool box	511
Tiranti starter	448	Tool for remove and replace fuel cock	450
Trasmissioni freno-frizione-cambio-starter-gas	337->341	Top box door	305
Trasmissioni contakm.	333->335	Transmission brake, throttle,clutch,starter,gear	337->341
Tubi comando cambio -gas	436->440	Transmission speedometer	333->335
		Trim, mudguards and hoods	302
Ventola volano	530	Union pipe	455->456
Viti carico/scarico olio motore	393	Union exhaust pipe and gaskets	296
Viti carter motore	351+352	Voltage regulator	533
Viti coperchi ventola	502	Washers fo bearing ball trackr	276
Viti fissa leve freno e frizione	446	Wires, electrical equipment	547->550
Viti fissa listelli tappetini centrali	493	Wheel rims	281->282
Viti fissa parafango	298	Wheel axle - front	279
Viti per ruote	280	Wheel axle - rear spare parts	411->412
		Wheel bracket and covers	292

VESPA

ammortizzatori

shock absorbers



ruota il catalogo
sfoglia il fascicolo dedicato

*turn the catalog
look at the dedicate booklet*





PARTI x MONTAGGIO AMMORTIZZATORI

PARTS FOR SHOCK ABSORBERS MOUNTING



ART. 5265

VITE TESTA BOMBATA (Sim. 9141)
TE CHIAVE 17 - M10 x 30
attacco superiore ammortizzatori
sec. upper shock absorbers
VESPA



ART. 5266

VITE TESTA BOMBATA (Sim. 9142)
TE CHIAVE 17 - M10 x 60 - STELO Ø 11
attacco inferiore ammortizzatori anteriori
sec. lower front shock absorbers
VESPA



ART. 5268

VITE TE CHIAVE 14 - M9 x 65 (Sim. 14689)
completo di rondella e dado
per attacco inferiore ammortizzatori posteriori
complete with washer and nut-sec. lower rear damper
VESPA

ART. 3119

DADO BASSO M9 - CHIAVE 13
per vite attacco inferiore ammortizzatore posteriore
nut for screw sec. lower rear shock absorbers
VESPA (Sim. S20209)



ART. 3129-GR

RONDELLA GROWER DIAM. 9
(Sim. 16409)

VESPA 50-125 PRIMAVERA-ET3-PX PE
VESPA PK TUTTI MODELLI / ALL MODELS
VESPA 50 N-L-R-SPRINT-SUPER-RALLY 200
VESPA GT 125 ('66-'73) - TS 125

ART. 5684

SUPPORTO ELASTICO INFERIORE
attacco ammortizzatore
posteriore al motore
lower buffer for fix rear shockabsorber at engine
(Sim. 157103-040316)



ART. 5680

SUPPORTO ELASTICO
per ammortizzatori posteriori
rear shock absorbers buffer
VESPA TUTTI TIPI
(Sim. 60536)



ART. 5684-KT

KIT SUPPORTO ELASTICO
INFERIORE + BUSSOLA IN FERRO
attacco ammortizzatore
posteriore al motore
lower buffer + iron bush **KIT**
for fix rear shockabsorber at engine



ART. 6480

TAMPONE DI RISCONTRO
(SUPERIORE) (Sim. 057012)
upper buffer
DIMENSIONI / DIMENSIONS:
Ø INTERNO / INTERNAL mm. 14
Ø ESTERNO / EXTERNAL mm. 31
SPESSORE / THICKNESS mm. 9

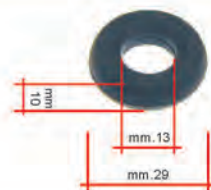

ART. 6482

TAMPONE DI RISCONTRO
(SUPERIORE) (Sim. 174085)
upper buffer
DIMENSIONI / DIMENSIONS:
Ø INTERNO / INTERNAL mm. 16
Ø ESTERNO / EXTERNAL mm. 33
SPESSORE / THICKNESS mm. 10



ART. 3134

BUSSOLA IN FERRO
per supporto elastico attacco inferiore
ammortizzatore posteriore
iron bush for lower buffer for fix rear shockabsorber at engine



ART. 6485

TAMPONE DI RISCONTRO
(SUPERIORE) (TIPO PICCOLO)
upper buffer (small type) (Sim. 178150)
DIMENSIONI / DIMENSIONS:
Ø INTERNO / INTERNAL mm. 12
Ø ESTERNO / EXTERNAL mm. 31
SPESSORE / THICKNESS mm. 18



ART. 6400-E

ESTENSIONE per adattare
ammortizzatore posteriore
extension to adapt rear shock absorbers
VESPA PX FRENO A DISCO
VESPA LML STAR 2T



ART. 6400-E4T

ESTENSIONE per adattare
ammortizzatore posteriore
extension to adapt rear shock absorbers
VESPA LML STAR 4T



ART. 6486

TAMPONE DI RISCONTRO
(INFERIORE) (TIPO GROSSO)
lower buffer (big type) (Sim. 178149)
DIMENSIONI / DIMENSIONS:
Ø INTERNO / INTERNAL mm. 13
Ø ESTERNO / EXTERNAL mm. 38
SPESSORE / THICKNESS mm. 21



FORCELLE

FORKS



ART. **5869**

FORCELLA / FORK

VESPA 50 - 90 - PRIMAVERA - VESPA 125 ET3

(Sim. 183678)



ART. **7016**

ANELLO OR 362 (28,24X2,6) parapolvere per perno forcella
RING for front suspension pin

VESPA 50 - 90 - 125 PRIMAVERA - ET3 - PK 50

(Sim. 93188- 14013)



ART. **15192**

ESTRATTORE / RICOLLOCATORE

PER ASTUCCI A RULLI PERNO SOSPENSIONE FORCELLA

REMOVER / REPLACER ROLLER CAGE PIN FORK SUSPENSION

VESPA 50-90-125 PRIMAVERA ET3

VESPA PK 50 - PK 50 XL



ART. **6153**

FORCELLA / FORK

VESPA PK 50 - PK 50 XL

(Sim. 244830)



FORCELLE

FORKS



ART. **5868**

FORCELLA COMPLETA DI BRACCIO
FORK COMPLETE WITH ARM

(asse ruota / wheel axle Ø mm. 18)

VESPA PX 1ª serie

(Sim. 183435)



ART. **5867**

FORCELLA COMPLETA DI BRACCIO
FORK COMPLETE WITH ARM

(asse ruota / wheel axle Ø mm. 22)

VESPA PX 2ª serie

(Sim. 178050)



ART. **5867-A**

FORCELLA COMPLETA DI BRACCIO
FORK COMPLETE WITH ARM

(asse ruota / wheel axle Ø mm. 22)

VESPA PX PE ARCOBALENO

(Sim. 216744)



ART. **5861**

FORCELLA

FORK

VESPA RALLY 180 (VSD1T)
VESPA RALLY 200 (VSE1T)
VESPA SPRINT 150 (VLB1T)
VESPA GTR 125 (VNL2T)
VESPA GT 125 (VNL2T)
VESPA GL 150 (VLA1T)

(Sim. 152339.5)

RICAMBI FORCELLE FORKS SPARE PARTS

VESPA PX PE 1^a SERIE



ART. **5866**
BRACCIO SOSPENSIONE FORCELLA
FORK SUSPENSION ARM
(Sim.1834365)



ART. **6161**
ASSE RUOTA Ø mm. 18
WHEEL AXLE



ART. **5824**
ASTUCCIO A RULLI (18-24-12) SUL PIATTO PORTA GANASCE
ROLLER CAGE ON BRAKE SHOES PLATE
(Sim. 132094)



ART. **5826**
ASTUCCIO A RULLI (16-22-16) SUL TAMBURO
ROLLER CAGE ON DRUM
(Sim. 174710)



ART. **5126**
PERNO SNODO FORCELLA ANTERIORE COMPLETO
FRONT SUSPENSION PIN



RICAMBI FORCELLE

FORKS SPARE PARTS

VESPA PXE ARCOBALENO 125-150-200 ('81-'97) - **PX 125-150-200** ('98-'01) - **PX EU2 125** ('01-'07)
VESPA T5 125 ('85-'89) - **PK 125** ('82-'84) - **PK XL 125** ('86-'89)
VESPA PKS 50-125 AUTOMATICA ('84-'89) - **RUSH 50** ('88-'89) - **FL 50** ('90) - **FL 125** ('89-'90)
VESPA FL2 AUTOMATICA 50 ('90-'91) - **FL2 HP 50** ('91-'97) - **N 50** ('89-'90)
VESPA COSA CL-CLX 125-150-200 ('88-'91) - **COSA 2 125-150-200** ('91-'97)



ART. **5865**

BRACCIO SOSPENSIONE FORCELLA

FORK SUSPENSION ARM

(Sim.1780515)



ART. **6161-A**

ASSE RUOTA Ø mm. 22

WHEEL AXLE



ART. **5832**

ASTUCCIO A RULLI (22-28-12) SUL PIATTO PORTA GANASCE

ROLLER CAGE ON BRAKE SHOES PLATE

(Sim. 177436)



ART. **5834**

ASTUCCIO A RULLI (20-26-16) SUL TAMBURO

ROLLER CAGE ON DRUM

(Sim. 177442)



ART. **5129**

PERNO SNODO FORCELLA ANTERIORE COMPLETO

FRONT SUSPENSION PIN

COPERCHI MOLLEGGIO

FORKS COVERS



ART. **5175**

SCATOLETTA IN METALLO COPRIMOLLEGGIO FORCELLA
METAL BOX FOR FORK SPRING

(Sim. 070176)

VESPA 50 - PRIMAVERA - ET3 - PK

VESPA 50 - 125 PRIMAVERA - ET3



ART. **5872-A**

COPERCHIETTO IN ALLUMINIO LUCIDO
FORK COVER IN POLISHED ALUMINIUM

(Sim. 070177)



ART. **5872-AR**

COPERCHIETTO IN ALLUMINIO COLORE ROSSO / ALUMINIUM RED COLOUR

(ABBINABILE AD AMMORTIZZATORI SPORTIVI COLORE ROSSO)
(COMBINABLE WITH RED SPORTS SHOCK ABSORBERS)



ART. **5872-AB**

COPERCHIETTO IN ALLUMINIO COLORE BLU / ALUMINIUM BLUE COLOUR

(ABBINABILE AD AMMORTIZZATORI SEBAC)
(COMBINABLE WITH SEBAC SHOCK ABSORBERS)



ART. **5872-AN**

COPERCHIETTO IN ALLUMINIO COLORE NERO / ALUMINIUM BLACK COLOUR

SPECIFICO PER / SPECIFIED FOR : **VESPA PRIMAVERA ET3 dal/since 1980->**



ART. **5872-CARB**

COPERCHIETTO IN ALLUMINIO EFFETTO CARBONIO
ALUMINIUM, LOOK CARBONIO



ART. **5872-N**

COPERCHIETTO IN PLASTICA NERO / BLACK PLASTIC



ART. **5872-B**

COPERCHIETTO IN PLASTICA BIANCO / WHITE PLASTIC



COPERCHI MOLLEGGIO

FORKS COVERS

VESPA PX PE 1ª SERIE



ART. **5873-N**

COPERCHIETTO IN PLASTICA NERO
FORK COVER IN PLASTIC, BLACK COLOUR

(Sim.174359)



ART. **5873-G**

COPERCHIETTO IN PLASTICA GRIGIO
FORK COVER IN PLASTIC, GREY COLOUR



ART. **5873-B**

COPERCHIETTO IN PLASTICA BIANCO
FORK COVER IN PLASTIC, WHITE COLOUR



CARBON LOOK

ART. **5873-CARB**

COPERCHIETTO IN PLASTICA **EFFETTO CARBONIO**
FORK COVER IN PLASTIC, LOOK CARBONIO

VESPA PX 2ª SERIE - PX ARCOBALENO - 125 T5 - VESPA COSA



ART. **5879**

COPERCHIETTO IN PLASTICA GRIGIO CHIARO
FORK COVER IN PLASTIC, LIGHT GREY COLOUR

(Sim.178048)

VESPA 125 (VNB6T ('65-'66) - SUPER 150 (VNC1T) - GT (VNL2T) - GTR (VNL2T) - TS (VNL3T) VESPA 150 SPRINT (VLB1T) - SPRINT VELOCE (VLB1T) - RALLY 180/200 (VSD1T-VSE1T)



ART. **5880**

COPERCHIO IN ALLUMINIO
FORK COVER IN ALUMINIUM

(Sim.079227)

VESPA 125 ('51-'55)-('60-'64) - VESPA 150 ('55-'66) - GL 150 - GS 150



ART. **5881**

COPERCHIO IN ALLUMINIO
FORK COVER IN ALUMINIUM

(Sim.015435)

SERIE CALOTTE STERZO

BEARING BALL TRACK

Made in Italy

VESPA 50-125 (67-82) - 125 (55-65) - FL 50 (90) - FL 125 (89-90) - FL2 AUTOMATICA 50 (90-91) - FL2 HP 50 (91-97)
 VESPA GS - SUPER SPORT 150 (55-65) - N 50 (89-90) - PK 50 (82-84) - PK AUTOMATICA 50 (84-89) - PK XL 50 (85-88)
 VESPA PK XL 125 (86-89) - PK XL PLURIMATIC 50 (85-90) - RUSH 50 (88-89) - PX 125 (98-01) - PX E 150 (98-05)
 VESPA PX EU2 125 (01-07) - PXE ARCOBALENO 125 (81-97) - PX 125/150 (11-17) - SPRINT - GR - SUPER
 VESPA RALLY (65-76) - T5 125 (85-89) - COSA 2 125 (91) - COSA CL-CLX 125 (88-91)

VESPA ET2 50-ET2 INIEZIONE 50-ET4 50/125-946 4T 3V ABS-946 RED EMEA, APAC 125(13-19)-946 4T 3V ABS ARMANI 125(2015)-946 CD E5 ABS 125 ELETTRICA (18-19) - ELETTRICA 25KM/H (2019) - ELETTRICA MOTOCICLO (2019) - ELETTRICA MOTOCICLO 70KM/H (19-20)-GRANTURISMO 125 (03-07) GRANTURISMO EU3 125 (06-07)-GTS ABS 250 (05-12)-GTS-GTS SUPER IE ABS E4 (EMEA)-GTS 300 (16-18)-GTS 4T E4 ABS (EMEA) 150 (16-18) - GTS 4T IE SUPER 125(09-16)-GTS EU3 125(07-12)-GTS HPE 4T/4V IE ABS E4 300 (2019)-GTS IE & TOURING 300 (12-16)-GTS IE ABS E4 (EMEA) 125 (16-18) GTS IE ABS E4 125 (2019)-GTS IE ABS E4 ABS 4T SUPER 125 (18-20)-GTS IE TOURING 300 (11-12)-GTS SUPER 300 (08-16)-GTS SUPER HPE-TECH 4T 4V IE ABS 300 (18-20)-GTV 125 (06-08)-GTV 250 (06-09)-GTV 4T NAVY EU3 125(08)-GTV 4T NAVY EU3 250(07)-GTV SEI GIORNI IE E4 ABS (EMEA) 300 (2017)-GTV VIA MONTENAPOLEONE 300 (2010)-LT 4T 3V IE 150 (2014)-LX 125/150 (05-06)-LX 2T 50 (2005-13)-LX 2T TOURING & 30KM 50 (10-13) LX 4T 3V IE - TOURING 125/150 (12-13)-LX 4T EU3 TOURING 125 (10-11)-LX 4T FL 125/150 (2009)-LX 4T-4V TOURING 50 (10-13)-LX EU 3 125 (06-08) LX EU 3 150 (06-08)-LX EU 3 IE 125/150 (09-11)-LX PRIMAVERA 4T 3V IE 125 (13-17)-LXV 2T 50 (06-09)-LXV 2T NAVY 50(08)-LXV 4T EU3 125 (06-09) LXV 4T NAVY EU3 125 (07-08)-LXV IE 4T 125 (10-13)-PRIMAVERA 2T 50 (13-17)-PRIM.4T 2V 25 KM/H 50 (14-17)-PRIM.4T 3V 25 KM/H E4 50 (17-19) PRIMAVERA 4T 3V E4 IGET ABS 125(16-20)-PRIM.4T-3V 150 (13-16)-PRIM.4T-3V NOABS E4 50 (17-20)-PRIM.4T-4V NO ABS 50 (13-17)-S 2T & COLLEGE 50 (07-12)-S 4T 150 (08-09)-S 4T 3V IE 125 (12)-S 4T EU3 125 (07-08)-S 4T IE & COLLEGE 125/150 (09-11)-S 4T-4V & COLLEGE 50 (08-12)-SPRINT 2T NO ABS E2 50 (14-17)-SPRINT 4T 2V 25 KM/H 50 (14-17)-SPRINT 4T 3V 25 KM/H E4 50 (17-20)-SPRINT 4T 3V IE 125/150 (14-15)-SPRINT 4T 4V NO ABS E2 EMEA 50 (14-17)-SPRINT 4T-3V E4 50 (17-20)-SPRINT SPORT 4T 3V IGET ABS 150 (16-19)-VESPA SXL 4T 3V CARB 150 (2019)
 PIAGGIO:MYMOOVER DELIVERY 4T 4V E5 125(21)-MYMOOVER POSTE ITALIANE 125(2021)-PIAGGIO 1 MOPED (2021)-PIAGGIO 1 MOTORCYCLE (2021)
 BEVERLY-CARNABY 125/200-FLY 2T 50-FLY 4T 50-FREE 100-HEXAGON-LIBERTY 50/125/200-MP3-NRG 50-NTT 50-QUARTZ 50-SFERA 50/125-SFERA MAQUILLAGE 2-SKIPPER-SKR CITY-SUPER HEXAGON-X EVO 125/250/400-X10 4T 4V IE EU3 500 (12-14) ZIP 50 - ZIP 125
 GILERA:EASY MOVING-GP CENTENARIO 800 (09)-ICE 50-NEXUS EU3 125/250-RUNNER-STALKER-STORM EU2 50-TYPHOON 50-2T EU2 50-4T 2V EU3 125
 SCOOTER APRILIA: SCARABEO LIGHT 300 (09-10) - SCARABEO LIGHT 400/500 (06-08) -SPORT CITY ONE 2T 50 (08-11)-SPORT CITY ONE 4T 50 (08-10)
 SPORT CITY ONE 4T EU3 125 (08-11) - SR MOTARD 125 (12-14) - SR MOTARD 2T 50 (12-14) - SR MOTARD 4T 4V 50 (13-19)



ART. 5611-SHQ

SR.CALOTTE STERZO **SUPERIORE**
 COMPLETA DI GHIERA FILETTATA DI SERRAGGIO+GABBIA
 (Nr. 5 pz.)

"HIGH QUALITY" MADE IN ITALY

COMPLETE **UPPER** BEARING BALL TRACK
 WITH CAGE AND THREADED RING
 (No. 5 pcs.)

(Sim.65069345 - 56002R - 153025)



ART. 5611-IHQ

SR.CALOTTE STERZO **INFERIORE**
 COMPLETA DI GHIERA
 (Nr. 4 pz.)

"HIGH QUALITY" MADE IN ITALY

COMPLETE **LOWER** BEARING BALL TRACK
 WITH THREADED RING
 (Nr. 4 pcs.)

(Sim. 650075-56003R)



SERIE CALOTTE STERZO

BEARING BALL TRACK

Made in Italy



ART. 5611-S

SERIE CALOTTA STERZO **SUPERIORE**
COMPLETA DI GABBIA (Nr. 3 pz.)

MADE IN ITALY

UPPER BEARING BALL TRACK COMPLETE WITH CAGE
(No. 3 pcs.)

(Sim.65069345 - 56002R - 153025)



ART. 5611-I

SERIE CALOTTA STERZO **INFERIORE**
COMPLETA DI GABBIA (Nr. 2 pz.)

MADE IN ITALY

LOWER BEARING BALL TRACK COMPLETE WITH CAGE
(Nr. 2 pcs.)

(Sim.650075-56003R)

HIGH QUALITY



ART. 10390

GHIERA FILETTATA DI SERRAGGIO
PER SERIE STERZO **SUPERIORE**

THREADED RING SEC. UPPER BEARING BALL TRACK

(Sim.0111094)

APPLICAZIONE ANCHE SU :
APE MIX 50 2T (98-08) - APE 50 2T EU4 (18-20)

ART. 6600

RONDELLA **SUPERIORE**
PER SERIE STERZO

UPPER WASHER FOR BEARING BALL TRACK

Ø INTERNO / INTERNAL mm. 30,2 x 40 x 2,5

(Sim.003751)



ART. 5615

GABBIA (mm. 31,4 x 39,6 x 2,6)
PER SERIE STERZO **SUPERIORE**

CAGE FOR
UPPER BEARING BALL TRACK

HIGH QUALITY



ART. 6601

RONDELLA PARAPOLVERE
PER SERIE STERZO **INFERIORE**

DUST WASHER FOR LOWER
BEARING BALL TRACK

Ø INTERNO / INTERNAL mm.34,5

Ø ESTERNO / EXTERNAL mm.63



ART. 5616

GABBIA (mm. 43 x 53 x 6,5)
PER SERIE STERZO **INFERIORE**

CAGE FOR
LOWER BEARING BALL TRACK

HIGH QUALITY



PERNI SOSPENSIONE

SUSPENSION PINS

COMPLETI (CON ASTUCCI INA/NADELLA) / COMPLETE (WITH INA/NADELLA ROLLER CAGE)



ART. 5113

PERNO SOSPENSIONE ANTERIORE COMPLETO
FRONT SUSPENSION PIN, COMPLETE

VESPA 50 - 90 - 125 PRIMAVERA
VESPA PRIMAVERA 125 ET3
VESPA PK 50 - PK 50 XL

(Sim. 70181)



ART. 5802

ASTUCCIO
ROLLER CAGE
(SIM.90457)



ART. 5126

PERNO SOSPENSIONE ANTERIORE COMPLETO
FRONT SUSPENSION PIN, COMPLETE

VESPA PX PE 1ª SERIE



ART. 5129

PERNO SOSPENSIONE ANTERIORE COMPLETO
FRONT SUSPENSION PIN, COMPLETE

VESPA PX PE 2ª SERIE - PX PE ARCOBALENO - 125 T5
VESPA PK 50 FL2 - PK 125 - RUSH N - VESPA COSA
SCOOTER SFERA - QUARTZ



ART. 5116

PERNO SOSPENSIONE ANTERIORE COMPLETO
FRONT SUSPENSION PIN, COMPLETE

VESPA DAL 1953 AL 1963



ART. 5118

PERNO SOSPENSIONE ANTERIORE COMPLETO
FRONT SUSPENSION PIN, COMPLETE

(Sim.091621-078731)

VESPA GL 150 (VLA1T) - SPRINT 150 (VLB1T)
VESPA GTR125 (VNL2T) - GT125 (VNL2T) - SUPER- RALLY 180 (VSD1T)
VESPA RALLY 200 (VSE1T)
VESPA TS 125 (VNL3T) - (VNB5T (026921)->VNB6T) - (VBB2T (212456))



ART. 5119

PERNO SOSPENSIONE ANTERIORE COMPLETO
FRONT SUSPENSION PIN, COMPLETE

VESPA GS 160



CUSCINETTI MOZZO RUOTA ANT.

FRONT WHEEL AXLE BEARINGS



ART. **16201** CUSCINETTO SKF (6201-2RSH) **(12 - 32 - 10)**
2 LATI SCHERMATI / 2 SIDES SCREENED
VESPA PX 1ª SERIE

ART. **16209** CUSCINETTO SKF (6202-2RSH) **(15 - 35 - 11)**
2 LATI SCHERMATI / 2 SIDES SCREENED
VESPA PX ARCOBALENO

ART. **16210** CUSCINETTO SKF (6203-2RSH) **(17 - 40 - 12)**
2 LATI SCHERMATI / 2 SIDES SCREENED
VESPA

GHIERE BLOCCAGGIO CUSCINETTO

RING SEC. WHEEL BEARING



ART. **4950** GHIERA BLOCCAGGIO CUSCINETTO RUOTA ANTERIORE (Sim. 57940)
RING SEC. **FRONT WHEEL BEARING**

Ø INTERNO / INTERNAL mm.25 - M34x1,5 mm.

VESPA 50 - 50S - 50 SPECIAL - 50 ELESTART - 50 SPRINTER
VESPA 90 - 125 PRIMAVERA ET3 - VESPA 125 (VMA '65-'67)
VESPA 150 (VBA '59-'60) - PK 50 - PK 50S - PX 50 XL



ART. **4951** GHIERA BLOCCAGGIO CUSCINETTO RUOTA POSTERIORE (Sim. 46688)
RING SEC. **REAR WHEEL BEARING**

FILETTO / THREAD Ø M48,75 x 1,5 SX
BORDO / EDGE mm. 4,15
Ø INTERNO / INTERNAL mm. 37

VESPA 125 (VNA) - VESPA 150 (VBA)



ART. **4952** GHIERA BLOCCAGGIO CUSCINETTO RUOTA POSTERIORE (Sim. 2/110415)
RING SEC. **REAR WHEEL BEARING**

FILETTO / THREAD Ø M48,75 x 1,5 SX
BORDO / EDGE mm. 2,65
Ø INTERNO / INTERNAL mm. 40

VESPA 125 (VNB '60) - VESPA 150 (VBB '61-'62)
VESPA SUPER 125 (VNC) - SUPER 150 (VBC)

ART. **4953** GHIERA BLOCCAGGIO CUSCINETTO RUOTA POSTERIORE (Sim. 2/52763)
RING SEC. **REAR WHEEL BEARING**

FILETTO / THREAD Ø M54 x 1,5 SX
BORDO / EDGE mm. 5,20
Ø INTERNO / INTERNAL mm. 40

VESPA GS 160 (VSB) - VESPA 180SS

ASSI RUOTA ANTERIORE

FRONT WHEEL AXLES



ART. 5145

ASSE RUOTA ANTERIORE
VERSIONE A 4 FORI PER DUE POSIZIONI COPPIGLIA

*FRONT WHEEL SHAFT
WITH 4 HOLES FOR TWO POSITION SPLIT PIN*

VESPA 50-90-125 PRIMAVERA - ET3
VESPA PK 50 - PK 50 XL

(Sim. 1582516)



ART. 5147

ASSE RUOTA ANTERIORE **z12**

VESPA SPRINT - RALLY

(Sim. 78741-180150)



ART. 5148

ASSE RUOTA ANTERIORE **z13**

VESPA P150S - VESPA SUPER

(Sim. 180115-153179)



ART. 5909

PARAOLIO Corteco (25 - 40 - 7)
PER RUOTA ANTERIORE / *FRONT WHEEL OIL SEAL*
VESPA 50-90-PRIMAVERA-ET3 - VESPA PK 50

(Sim. 128217)



ART. 5943

PARAOLIO Corteco (24 - 40 - 7)
PER RUOTA ANTERIORE / *FRONT WHEEL OIL SEAL*
VESPA 50-90-PRIMAVERA-ET3

(Sim. 8708)



ART. 5946

PARAOLIO Corteco (17 - 40 - 7)
PER RUOTA ANTERIORE / *FRONT WHEEL OIL SEAL*
VESPA 50 R - L - RALLY-SPRINT - SUPER - TS - GTR

(Sim. 8722)



DADI - VITI PER RUOTA

WHEEL NUTS, SCREWS



ART. **5032**

DADO PER CERCHI RUOTA
ESAGONO mm.11 - FILETTO M8

WHEEL RIMS NUT,
HEXAGON mm.11 - THREAD M8
VESPA OLD MODELS '59



ART. **3118**

DADO PER CERCHI RUOTA
ESAGONO mm.13 - FILETTO M8

WHEEL RIMS NUT,
HEXAGON mm.13 - THREAD M8



ART. **3128-GR**

RONDELLA GROWER Ø mm. 8
GROWER WASHER mm. 8



ART. **5034**

VITE M10 (RESISTENZA 8.8)
CHIAVE mm.17
FISSA CERCHIO AL TAMBURO
RUOTA ANTERIORE E POSTERIORE

SCREW SEC. RIM AT DRUM
FRONT & REAR WHEEL
(RESISTENCE 8.8) - KEY 17

VESPA 50 - 90 DAL 1966 AL 1973
(Sim. 70156)



ART. **5040**

DADO M10
CHIAVE ESAGONO mm.22
FISSA RUOTA 8"
ANTERIORE E POSTERIORE

NUT M10 - HEXAGON mm.22
SEC. FRONT & REAR WHEEL 8"

VESPA - APE
(Sim. 012131)



ART. **4900**

DADO M8
CHIAVE ESAGONO mm. 22
FISSA RUOTA 8"
ANTERIORE E POSTERIORE

NUT - M8 - HEXAGON mm.22 -
SEC. FRONT & REAR WHEEL 8"

VESPA TUTTI I TIPI DAL 1946 AL 1961



ART. **5035**

DADO FRESATO Ø 14 - CHIAVE 22 - FISSA RUOTA POSTERIORE (Sim. 2314)
MILLED NUT SEC. REAR WHEEL - Ø mm.14 - KEY 22

VESPA TUTTI TIPI FINO ARCOBALENO

VESPA PK - PK XL - N - FL2 - PX PE ARCOBALENO

SCOOTER PIAGGIO - GILERA



ART. **6622-KT**

KIT SCODELLINO, DADO E COPPIGLIA
PER ASSE RUOTA POSTERIORE

SET OF CAP SEC NUT + NUT + SPLIT PIN FOR REAR
WHEEL AXLE



ART. **6622**

SCODELLINO RUOTA POSTERIORE (Sim.194423)
CAP SEC NUT REAR WHEEL AXLE



ART. **6623**

DADO RUOTA POSTERIORE
REAR WHEEL AXLE NUT

(Sim.194424)



ART. **6627**

COPPIGLIA PER ASSE RUOTA POST.
SPLIT PIN FOR REAR WHEEL AXLE

CERCHI RUOTA

WHEEL RIMS



ART. **10190**

Ø ESTERNO mm. 278
IN LAMIERA VERNICIATO GRIGIO METALIZZATO
(MONTA GOMME 3.00 X 10 - 3,50 X 10)

EXTERNAL Ø mm. 278
SHEET, METALLIZED GREY PAINTED (FOR TYRES 3.00 X 10 - 3,50 X 10)

VESPA 50 - 125 PRIMAVERA - 125 ET3 - PK - PX
VESPA RALLY 180 - 200



ART. **10190-CARB**

Ø ESTERNO mm. 278
IN LAMIERA **EFFETTO CARBONIO**
(MONTA GOMME 3.00 X 10 - 3,50 X 10)

EXTERNAL Ø mm. 278
SHEET, LOOK CARBONIO (FOR TYRES 3.00 X 10 - 3,50 X 10)

VESPA 50 - 125 PRIMAVERA - 125 ET3 - PK - PX
VESPA RALLY 180 - 200



2-3/4x9"

ART. **10182**

PER TAMBURO A 4 ATTACCHI

(Sim.135172)

Ø ESTERNO mm. 248
VERNICIATO GRIGIO METALIZZATO

FOR DRUM AT 4 ATTACKS
EXTERNAL Ø mm. 248 - METALLIZED GREY PAINTED

VESPA 50 R ('71-'76) - VESPA 50 SPECIAL 3 MARCE



ART. **10183**

TRASFORMAZIONE PER TAMBURO IN GHISA A 4 ATTACCHI
(PER PORTARE IL CERCHIO DA PICCOLO A 3,50x10")

Ø ESTERNO mm. 278
VERNICIATO GRIGIO METALIZZATO

TRANSFORMATION FOR CAST IRON DRUM AT 4 ATTACKS
TO BRING THE RIM FROM SMALL TO 3,50x10")
EXTERNAL Ø mm. 278 - METALLIZED GREY PAINTED

VESPA 50



CERCHI RUOTA

WHEEL RIMS



2-3/4x9"

ART. **10187**

Ø ESTERNO mm. 248
VERNICIATO GRIGIO METALLIZZATO

(Sim.98012)

EXTERNAL Ø mm. 248 - METALLIZED GREY PAINTED

VESPA V5A1T ('63-'65)

VESPA 50 N ('63-'69) CON SPORTELLINO PICCOLO LATO MOTORE
WITH SMALL DOOR ON THE ENGINE SIDE



3,00x10"

ART. **10188**

Ø ESTERNO mm. 278
VERNICIATO GRIGIO METALLIZZATO

(Sim.098011)

EXTERNAL Ø mm. 278 - METALLIZED GREY PAINTED

VESPA 50 S - VESPA 90

VESPA 50 PER MODIFICA / FOR MODIFIED



3,50x8"

ART. **10184**

Ø ESTERNO mm. 235
VERNICIATO GRIGIO METALLIZZATO

(Sim.1103765)

EXTERNAL Ø mm. 235 - METALLIZED GREY PAINTED

VESPA SUPER 125-150



3,50x8"

ART. **10185**

Ø ESTERNO mm. 235
VERNICIATO GRIGIO METALLIZZATO

(Sim.014894)

EXTERNAL Ø mm. 235 - METALLIZED GREY PAINTED

VESPA 125 ('51-'65) - VESPA 150 ('55-'66)



4,00x10"

ART. **10189**

Ø ESTERNO mm. 278
VERNICIATO GRIGIO METALLIZZATO
(5 FORI D'ATTACCO)

EXTERNAL Ø mm. 278 - METALLIZED GREY PAINTED
(5 ATTACK HOLES)

VESPA GS 160 - 180 SS

TAPPI TAMBURI ANT./POST.

FRONT / REAR DRUM PLUGS

TIPO GRANDE / BIG TYPE



ART. 5170-C

TAPPO CROMATO (TIPO GRANDE)
PER TAMBURO ANTERIORE/POSTERIORE
CHROMED PLUG (BIG TYPE) FOR FRONT / REAR DRUM

(Sim. 1C000523-092517-182546)

ANTERIORE E POSTERIORE / FRONT AND REAR:
VESPA 50 - 90 125 PRIMAVERA -ET3- PX 125 T5 -PX PE ARCOBALENO

SOLO POSTERIORE / ONLY REAR:
VESPA PX PE 1ª SERIE

PIAGGIO

FLY 50 4T ('05-'08) - FLY 4T MOTORI CHIN. 50 ('06-'07) - FLY 4T 100 ('06-'08) - FLY EU3 125 ('07-'08)
FLY EU3 150 ('08) - HEXAGON GTX 125-180 ('00) - LIBERTY 2T 50 ('06)-LIBERTY 2T SPORT 50 ('06-'08)
LIBERTY 4T 50 ('05-'08) - LIBERTY 4T SPORT 50 ('06-'08) - MP3 125 ('07-'08) - MP3 250 ('06-'08)
MP3 400 ('07-'08) - VESPA ET2 50 ('97-'05) - ET4 125-150 ('99-'02) - GRANTURISMO 125 ('03-'07)
GRANTURISMO 200 ('06-'07) - GRANTURISMO EU3 125 ('06-'07) - VESPA GT 60 EU3 250 ('06-'07)
VESPA GTS EU3 125 ('07-'08) - GTS SUPER 300 ('08) - GTS, GTS ABS 250 ('05-'8) - GTV 125 ('07-'08)
VESPA GTV 250 ('06-'07) - GTV4T NAVY EU3 125-250 ('08) - VESPA LX 2T-4T 50 ('05-'08)-LX 125('05-'06)
VESPA LX EU3 125 ('06-'08) - LX 150 ('05-'06) - LX EU3 150 ('06-'08) - LXV 2T 50('06-'08)
VESPA LXV 2T NAVY 50('08) - LXV 4T EURO3 50-125 ('06-'08) - LXV 4T NAVY EU3 125 ('08)
VESPA S 2T 50 ('07-'08) - S 4T EU3 125 ('07-'08) - ZIP RST 50 ('96-'99) - ZIP SP 50 ('96-'00)
ZIP SP EU2 50 ('06-'08) - ZIP 4T 50-100 ('06-'08) - ZIP 125 ('00-'02)

GILERA

FUOCO 500 ('07-'08)

TIPO PICCOLO / SMALL TYPE



SOLO ANTERIORE / ONLY FRONT:

VESPA125 - 150 - PX PE dal '78 al '82 - APE 50 tutti tipi

ART. 5172-C

TAPPO CROMATO (TIPO PICCOLO)
PER TAMBURO ANTERIORE
CHROMED PLUG (SMALL TYPE) FOR FRONT DRUM

(Sim.126410-181757)



ART. 5172-B

TAPPO BIANCO (TIPO PICCOLO) PER TAMBURO ANTERIORE
WHITE PLUG (SMALL TYPE) FOR FRONT DRUM



ART. 6280-B

COPERCHIO MOZZO BIANCO
PER TAMBURO ANTERIORE E POSTERIORE
WHITE HUB COVER, FRONT AND REAR DRUM

(Sim.266306)

VESPA PK - PK XL - PK FL2 - RUSH - N



ART. 6280-N

COPERCHIO MOZZO NERO
PER TAMBURO ANTERIORE E POSTERIORE
BLACK HUB COVER, FRONT AND REAR DRUM

(Sim.266306)

VESPA PK - PK XL - PK FL2 - RUSH - N



TAMBURI FRENO

BRAKE DRUMS

VESPA 50 R - 50 SPECIAL (1971) (3 marce / speed)



ART. **5420-A**

ANTERIORE / FRONT

IN GHISA - 4 ATTACCHI
CAST IRON - 4 CONNECTION

(Sim. 158252)



ART. **5420**

POSTERIORE / REAR

IN GHISA - 4 ATTACCHI
CAST IRON - 4 CONNECTION

(Sim. 112855.6)

VESPA 50 - 50 S (V5SA1T-V5A1T)



ART. **5421.05**

ANTERIORE / FRONT

IN ACCIAIO / STEEL

(Sim. 0993045)

Ø INTERNO ANELLO GANASCE / BRAKE SHOES RING mm.125
Ø FORO D'ATTACCO / CONNECTION HOLE mm. 36



ART. **5421.06**

POSTERIORE / REAR

IN GHISA / CAST IRON

(Sim. 79578)

Ø INTERNO ANELLO GANASCE / BRAKE SHOES RING mm.135
Ø FORO D'ATTACCO / CONNECTION HOLE mm. 36

VESPA SUPER



ART. **5421.01**

ANTERIORE / FRONT

IN GHISA / CAST IRON

(Sim. 110470)



ART. **5421.02**

POSTERIORE / REAR

IN GHISA / CAST IRON

(Sim. 110375-157743)

VESPA 125 - 150 (1958-1960)



ART. **5421.08**

POSTERIORE / REAR

IN ALLUMINIO / ALUMINIUM

(SIM. 23831)

Ø INTERNO ANELLO GANASCE / BRAKE SHOES RING mm.127
Ø FORO D'ATTACCO / CONNECTION HOLE mm. 52

TAMBURI FRENO

BRAKE DRUMS



ART. **5407**

ANTERIORE / FRONT

(Sim. 159374)

IN ALLUMINIO / ALUMINIUM

VESPA 50 - 90 - 125 PRIMAVERA - ET3



ART. **5408**

POSTERIORE / REAR

(Sim. 100484)

IN ALLUMINIO / ALUMINIUM

VESPA 50 - 90 - 125 PRIMAVERA - ET3



ART. **6276**

ANTERIORE / FRONT

(Sim. 226765)

IN ALLUMINIO / ALUMINIUM

VESPA PK 50 - PK 50 XL



ART. **6273**

POSTERIORE / REAR

(Sim. 215993)

IN ALLUMINIO / ALUMINIUM

VESPA PK 50/125 - PK XL 50/125

VESPA FL2 - RUSH - N



ART. **10159**

POSTERIORE / REAR

IN ALLUMINIO / ALUMINIUM

VESPA COSA



ART. **16204-2RS**

CUSCINETTO

SKF 6204-2RSH (20-47-14)

2 LATI SCHERMATI / 2 SCREENED SIDES

(SIM. 434735)

PER ASSE RUOTA POSTERIORE

BEARING FOR REAR WHEEL AXLE

VESPA TUTTI TIPI E SCOOTER



TAMBURI FRENO

BRAKE DRUMS



ART. **5160-A**

ANTERIORE / FRONT

(Sim. 078744)

IN ALLUMINIO / ALUMINIUM
(ATTACCO ASSE CONICO CON CHIAVETTA)
(CONICAL AXIS CONNECTION WITH KEY)

VESPA SPRINT - RALLY



ART. **5409-C**

ANTERIORE / FRONT

(Sim. 174032)

IN ALLUMINIO / ALUMINIUM
COMPLETO DI CUSCINETTO/COMPLETE WITH BEARING
(MONTA SU FORCELLA C/ASSE mm.18-16)

VESPA 125-150 - VESPA PX PE ('78-'82)



ART. **5160**

POSTERIORE / REAR

(Sim. 78480)

IN ALLUMINIO / ALUMINIUM
(MOZZETTO mm.27)

VESPA PX PE (FINO AL 1982) - SPRINT - GL



ART. **10162-C**

ANTERIORE / FRONT

(Sim. 177444)

IN ALLUMINIO / ALUMINIUM
COMPLETO DI CUSCINETTO/COMPLETE WITH BEARING
(MONTA SU FORCELLA CON ASSE mm.22-20)

VESPA PX PE ARCOBALENO - 125 T5

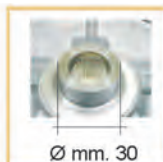

ART. **10164**

POSTERIORE / REAR

(Sim. 242772)

IN ALLUMINIO / ALUMINIUM
(MOZZETTO mm.30)

VESPA PX PE ARCOBALENO



ART. **10165**

POSTERIORE / REAR

(Sim. 245474)

IN ALLUMINIO / ALUMINIUM
(MOZZETTO mm.31,5)

VESPA 125 T5



GANASCE FRENO

BRAKE SHOES

VEICOLO VEHICLE	ANNO	ANTERIORE FRONT	POSTERIORE REAR
VESPA 50		GF 0162	GF 0130
VESPA PK 50		GF 0162	GF 0128
VESPA 50 SPECIAL		GF 0162	GF 0159
VESPA PK 50 XL	'86 ->	GF 0162	GF 0128
VESPA PK 50 XL		GF 0128	GF 0128
VESPA 50 FL	'90 ->	GF 0128	GF 0128
VESPA 125 PRIMAVERA - ET3		GF 0162	GF 0159
VESPA PK 125 - PK 125 XL		GF 0128	GF 0128
VESPA PX 125 - 150 - 200		GF 0128	GF 0128
VESPA PX 125 - 150 - 200 ARCOBALENO		GF 0128	GF 0128
VESPA PX 125 - 150 - 200 E FRENO A DISCO	'98 ->	BP 0266	GF 0128
VESPA COSA 125 - 150 - 200	'90 ->	GF 0250	GF 0249
VESPA 125 - 150	'51-'62	GF 0162	GF 0087
VESPA 125 - 150	'63-'72	GF 0162	GF 0127
VESPA 150 SPRINT VELOCE		GF 0024	GF 0128
VESPA 150 SUPER		GF 0162	GF 0160
VESPA 160 GS		GF 0024	GF 0128
VESPA 180 SS		GF 0024	GF 0128
VESPA 200 RALLY		GF 0024	GF 0128



150 x 25

GF0024



**ANTIACQUA
WATERPROOF**

GF0024-FTR



127 x 23

GF0087



**ANTIACQUA
WATERPROOF**

GF0087-FTR



127 x 23

GF0127



150 x 24

GF0128



**ANTIACQUA
WATERPROOF**

GF0128-FTR



GANASCE FRENO BRAKE SHOES



125 x 20

GF0130



**ANTIACQUA
WATERPROOF**

GF0130-FTR



150 x 24

GF0159



**ANTIACQUA
WATERPROOF**

GF0159-FTR



127 x 28

GF0160



125 x 17

GF0162



**ANTIACQUA
WATERPROOF**

GF0162-FTR



170 x 25

GF0249



170 x 25

GF0250



GANASCE - PASTIGLIE FRENO

BRAKE SHOES - BRAKE PADS

VEICOLO VEHICLE	ANNO	ANTERIORE FRONT	POSTERIORE REAR
VESPA PX 125 - 150 - 200 E FRENO A DISCO	'98 ->	BP0266	GF0128
VESPA ET2 50	'97 ->	BP0249	GF0261
VESPA ET2 INIEZIONE 50	'99	BP0249	GF0261
VESPA ET2 4T 50	'00-'01	BP0249	GF0261
VESPA ET4 50	'99 ->	BP0249	GF0261
VESPA ET4 125/150	'96-'02	BP0249	GF0261
VESPA GRANTURISMO L 125 (PINZA GRIMECA)	'03 ->	BP0195	BP0298
VESPA GRANTURISMO L 125 (PINZA HENG TONG)	'03 ->	BP0330	BP0298
VESPA GRANTURISMO L 200 (PINZA GRIMECA)	'03-'05	BP0195	BP0298
VESPA GRANTURISMO L 200 (PINZA HENG TONG)	'03 ->	BP0330	BP0298
VESPA GRANTURISMO 200 (PINZA GRIMECA)	'06 ->	BP0195	BP0298
VESPA GRANTURISMO 200 (PINZA HENG TONG)	'06 ->	BP0330	BP0298
VESPA GTS 250 (PINZA GRIMECA)	'05 ->	BP0195	BP0298
VESPA GTS 250 (PINZA HENG TONG)	'05 ->	BP0330	BP0298
VESPA GTS IE 300	'12 ->	BP0330	BP0298
VESPA GTS SUPER 300	'08 ->	BP0330	BP0298
VESPA GTS SUPER SPORT 300	'11 ->	BP0330	BP0298
VESPA GTV 250	'06 ->	BP0330	BP0298
VESPA GTV IE 300	'11 ->	BP0330	BP0298
VESPA LX 2T / 4T 50	'05 ->	BP0249	GF0261
VESPA LX 125/150	'05-'06	BP0249	GF0261
VESPA LX EU3 125/150	'06-'07	BP0249	GF0261
VESPA LX IE EU3 125/150	'09-'10	BP0249	GF0261
VESPA LX TOURING 2T 50	'10 ->	BP0249	GF0261
VESPA LX TOURING 4T 4V 50	'10 ->	BP0249	GF0261
VESPA LX TOURING 125/150	'10 ->	BP0249	GF0261
VESPA LXV IE 4T 125	'10 ->	BP0249	GF0261
VESPA PRIMAVERA 2T 50	'13 ->	BP0330	GF0261
VESPA PRIMAVERA 4T 4V 50	'13 ->	BP0330	GF0261
VESPA PRIMAVERA 4T 3V IE 125	'13 ->	BP0330	GF0261
VESPA PRIMAVERA 4T 3V 150	'13 ->	BP0330	GF0261
VESPA SPRINT 2T 50	'14 ->	BP0330	GF0261
VESPA SPRINT 4T 4V 50	'14 ->	BP0330	GF0261
VESPA S 4T IE & COLLEGE 125/150	'09-'10	BP0249	GF0261



110x25



GF0261

CP. GANASCE **POSTERIORI**
REAR BRAKE SHOES

VESPA ET2 50
VESPA ET2 INIEZIONE 50
VESPA ET2 4T 50
VESPA ET4 50
VESPA ET4 125 /150
VESPA LX 2T / 4T 50
VESPA LX 125-150
VESPA LX EU3 125-150
VESPA LX IE EU3 125-150
VESPA LX TOURING 2T 50 / TOURING 4T 4V 50
VESPA LX TOURING 125-150 - VESPA LXV IE 4T 125
VESPA PRIMAVERA 2T 50
VESPA PRIMAVERA 4T 4V 50
VESPA PRIMAVERA 4T 3V IE 125 /150
VESPA SPRINT 2T 50 (14->) - SPRINT 4T 4V
VESPA S 4T IE & COLLEGE 125-150

(97->)
(99)
(00-'01)
(99)
(96->'02)
(05->)
(05->'06)
(06->'07)
(09->'10)
(10->)
(10->)
(13->)
(13)
(13-'14)
(14->)
(10->)
(09->'10)



49,1 x 35 x 8,7



BP0249

CP. PASTIGLIE **ANTERIORI**
FRONT BRAKE PADS

VESPA ET2 50
VESPA ET2 INIEZIONE 50
VESPA ET2 4T 50
VESPA ET4 50
VESPA ET4 125 /150
VESPA LX 2T / 4T 50
VESPA LX 125-150
VESPA LX EU3 125-150
VESPA LX IE EU3 125-150
VESPA LX TOURING 2T 50 / TOURING 4T 4V 50
VESPA LX TOURING 125-150 - VESPA LXV IE 4T 125
VESPA S 4T IE & COLLEGE 125-150

(97->)
(99)
(00-'01)
(99)
(96->'02)
(05->)
(05->'06)
(06->'07)
(09->'10)
(10->)
(10->)
(10->)
(10->)
(09->'10)



PASTIGLIE FRENO

BRAKE PADS



31.7 x 51.1 x 6

ART. **BP0266**

CP. PASTIGLIE **ANTERIORI**
FRONT BRAKE PADS

VESPA PX 125 - 150 - 200 ARCOBALENO

(*98)



77 x 42 x8/95,5 x 42 x8

ART. **BP0195**

CP. PASTIGLIE **ANTERIORI**
FRONT BRAKE PADS

VESPA GRANTURISMO L 125 (pinza Grimeca)
VESPA GRANTURISMO L 200 (pinza Grimeca)
VESPA GRANTURISMO 200 (pinza Grimeca)
VESPA GTS 250 (pinza Grimeca)

(*03 >)
(*03-05)
(*06 >)
(*06->)
(*05->)



97 x 41 x 9

77 x 41 x 9

ART. **BP0330**

CP. PASTIGLIE **ANTERIORI**
FRONT BRAKE PADS

VESPA GRANTURISMO L 125 (pinza Heng Tong)
VESPA GRANTURISMO L 200 (pinza Heng Tong)
VESPA GRANTURISMO 200 (pinza Heng Tong)
VESPA GTS 250 (pinza Heng Tong)
VESPA GTS IE 300
VESPA GTS SUPER 300
VESPA GTS SUPER SPORT 300
VESPA GTV 250
VESPA GTV IE 300
VESPA PRIMAVERA 2T 50
VESPA PRIMAVERA 4T 4V 50
VESPA PRIMAVERA 4T 3V IE 125
VESPA PRIMAVERA 4T 3V 150
VESPA SPRINT 2T 50
VESPA SPRINT 4T 4V 50

(*03 >)
(*03 >)
(*06 >)
(*05->)
(*12->)
(*08->)
(*11->)
(*06->)
(*11->)
(*13->)
(*13->)
(*13-14)
(*13-14)
(*14->)
(*14->)



55,5 x 49 x 7,5

ART. **BP0298**

CP. PASTIGLIE **POSTERIORI**
REAR BRAKE PADS

VESPA GRANTURISMO L 125 (pinza Grimeca / Heng Tong)
VESPA GRANTURISMO L 200 (pinza Grimeca / Heng Tong)
VESPA GRANTURISMO 200 (pinza Grimeca / Heng Tong)
VESPA GTS 250 (pinza Grimeca / Heng Tong)
VESPA GTS IE 300
VESPA GTS SUPER 300
VESPA GTS SUPER SPORT 300
VESPA GTV 250
VESPA GTV IE 300

(*03 >)
(*03-05)
(*06 >)
(*05->)
(*12->)
(*08->)
(*11->)
(*06->)
(*11->)

VESPA COSA



ART. **9718**

POMPA FRENO
MASTER CYLINDER
VESPA COSA
(Sim. 229254)



ART. **9710**

CILINDRETTO FRENO ANTERIORE
FRONT BRAKE CYLINDER
VESPA COSA
(Sim.248846)



ART. **9711**

CILINDRETTO FRENO POSTERIORE
REAR BRAKE CYLINDER
VESPA COSA
(Sim. 228828)



ART. **5498**

MOLLA RICHIAMO PEDALE FRENO
RETURN SPRING FOR BRAKE LEVER
VESPA 50 - 125
(Sim.70994)



ART. **3048**

MOLLA RICHIAMO GANASCE FRENO POSTERIORE
RETURN SPRING FOR REAR BRAKE SHOES
VESPA 50 - 90 - 125 PRIMAVERA - ET3
VESPA PK - PK XL
(Sim.78522)



ART. **3049**

MOLLA RICHIAMO GANASCE FRENO ANTERIORE
RETURN SPRING FOR FRONT BRAKE SHOES
VESPA 50 - 90 - 125 PRIMAVERA - ET3
VESPA PK - PK XL
(Sim.25990)



ART. **G0678**

GOMMINO PROTEZIONE LEVA FRENO / BRAKE PEDAL GROMMET (Sim. 93100)

VESPA 125 (VNB3/4/5/6T '61-'66) - VESPA 150 (VBB1/2T '61-'66)
SUPER 125 ('66-'68) - SUPER 150 ('66-'79) - GRAN TURISMO (VNL1T dal telaio 30001 '66-'73)
GL 150 - GS 150 - GS 160 - 180 SS - RALLY 180-200



ART. **G0825**

GOMMINO PROTEZIONE LEVA FRENO
BRAKE PEDAL GROMMET

VESPA 50 (V5SS '66-'71 / V5A1T dal telaio 92877 '65-'67)
VESPA 90 (V9SS '65-'71) - VESPA 125 (VNA 1/2T '58-'59)
VESPA 125 ET3 (VMB1 '76-'83)
(Sim.100426)



ART. **G0900**

GOMMINO PROTEZIONE LEVA FRENO
BRAKE PEDAL GROMMET

VESPA 50 (V5A1T 914748>) - 50 SPECIAL (V5B3T 230536>)
VESPA 50 S (V5SA1T 79735>) - 90 (V9A1T 184927>)
VESPA 100 (V9B1T 5363>) - 125 PRIMAVERA (VMA2T 0192145>)
VESPA ET3 - PX 125-150-200

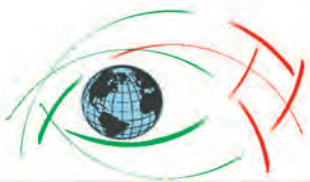

ACCESSORI RUOTA DI SCORTA

SPARE WHEEL ACCESSORIES



ART. 15601

SUPPORTO RUOTA DI SCORTA

INTERASSE PRIGIONIERI D'ATTACCO mm.197
(PER RUOTA 10")

*SPARE WHEEL BRACKET
WHEELBASE STUDS CONNECTION mm.197
(FOR WHEEL 10")*

VESPA 50 - 90 - 125 PRIMAVERA ET3
VESPA GL - GS - SPRINT



ART. 15602

SUPPORTO RUOTA DI SCORTA

INTERASSE PRIGIONIERI D'ATTACCO mm.73
(PER RUOTA 9")

*SPARE WHEEL BRACKET
WHEELBASE STUDS CONNECTION mm.73
(FOR WHEEL 9")*

VESPA 50 - 90 VECCHI MODELLI / OLD MODELS
(Sim.70805)



ART. 15603

SUPPORTO RUOTA DI SCORTA
INTERASSE PRIGIONIERI D'ATTACCO mm.175
(RUOTA 8")

*SPARE WHEEL BRACKET
WHEELBASE STUDS CONNECTION mm.175
(WHEEL 8")*

VESPA 125 - 150 SUPER
(Sim.101048)



ART. 15604

SUPPORTO RUOTA DI SCORTA
INTERASSE PRIGIONIERI D'ATTACCO mm.197
(PER RUOTA 9")

*SPARE WHEEL BRACKET
WHEELBASE STUDS CONNECTION mm.197
(WHEEL 9")*

VESPA 50 SPECIAL 3 MARCE
(Sim.610175M)



ART. 5200

GALLETTO M8 FERMO PIATTELLO RUOTA DI SCORTA
WING NUT M8 SEC SPARE WHEEL PLATE

VESPA 125 - 150 DAL 1958 AL 1966



ART. 15510

COPRIRUOTA PICCOLO PER RUOTA DI SCORTA DA 8"
CON TASCA PORTA DOCUMENTI

(Sim.610007M)

*SMALL WHEEL COVER FOR SPARE WHEEL 8"
WITH POCKET DOCUMENTS*

VESPA

ART. 15520

COPRIRUOTA GRANDE PER RUOTA DI SCORTA DA 10"
CON TASCA PORTA DOCUMENTI

(Sim.610007M001)

*BIG WHEEL COVER FOR SPARE WHEEL 10"
WITH POCKET DOCUMENTS*

VESPA

CRESTE PARAFANGO

MUDGUARD CRESTS

VESPA 50 (DAL 1963 FINO A VESPA R)
VESPA 125 (DAL VNB2 AL VNB6)
VESPA 125 PRIMAVERA-ET3-125/150 SUPER
VESPA 150 (VBA-VBB1-VBB2)



ART. **5275**

CRESTA PER PARAFANGO

IN ALLUMINIO LUCIDATO / POLISHED ALUMINIUM

(Sim.1500705)

VESPA 50 SPECIAL - SPRINT VELOCE - TS



ART. **5274**

CRESTA PER PARAFANGO
 IN ALLUMINIO LUCIDATO A MANO
 CON MOLLE GRANDI AD ALTA TENUTA

HIGH QUALITY

HAND POLISHED ALUMINIUM WITH
 BIG SPRINGS AT HIGH RESISTANCE

(Sim. 1247085)

VESPA PX 125 ('98-'01) - PX 30 ANNI ('07-'08)
PX EU2 125 ('01-'07) - PX 125/150 ('11-'17)
PX E 150 ('98-'05)



ART. **5279-AL**

CRESTA PER PARAFANGO
 IN ALLUMINIO LUCIDATO
 POLISHED ALUMINIUM

(Sim. 564219)



ART. **5274-E1**

CRESTA PER PARAFANGO
 IN ALLUMINIO LUCIDO
 COMPLETA DI MOLLE

POLISH ALUMINIUM,
 COMPLETE WITH SPRINGS

(Sim. 1247085)

VESPA PX PE TUTTE / ALL MODELS
VESPA PX ARCOBALENO
 adattabile a / suitable to : **VESPA 50**



ART. **5279**

CRESTA PER PARAFANGO
 TIPO LARGO / LARGE TYPE

(Sim. 198399)

VESPA PX TUTTE / ALL MODELS (1977->1983)



ART. **5278**

CRESTA PER PARAFANGO
 TIPO STRETTO / SLIM TYPE

(Sim. 1247085)



ART. **5279-CARB**

CRESTA PER PARAFANGO
 TIPO LARGO **EFFETTO CARBONIO**
 LARGE TYPE - LOOK CARBONIO



ART. **5278-CARB**

CRESTA PER PARAFANGO
 TIPO STRETTO **EFFETTO CARBONIO**
 SLIM TYPE - LOOK CARBONIO



CRESTE PARAFANGO

MUDGUARD CREST

VESPA 125 (VNA DAL 1958 AL 1959) - (VNB1)

sviluppo arco mm.170



ART. **5270** CRESTA PER PARAFANGO
CROMATA / CHROMED

VESPA 150 (DAL VL1 AL VL3) - **VESPA 150** (VB1)
VESPA GS 150 (DAL VS1 AL VS4)



ART. **5271** CRESTA PER PARAFANGO (Sim.023585)
IN ALLUMINIO / ALUMINIUM

VESPA GS 160 - SPRINT - GT - GTR - SS 180



ART. **5272** CRESTA PER PARAFANGO (Sim. 92714)
TIPO GROSSA
LUNGHEZZA cm. 20
BIG TYPE - LENGHT cm. 20



ART. **10380**
RONDELLA ELASTICA
per fissaggio creste
(Sim. 085508 - 268146)



ART. **5276**
BUSSOLETTA
x montaggio creste parafango
e protezioni posteriori scocche
VESPA



ART. **5277**
VITE TESTA CROCE
SVASATA mm. 2,9x13
x montaggio creste parafango
e protezioni posteriori scocche
VESPA



ART. **5277-TCA**
VITE TESTA TAGLIO
CACCIAVITE mm. 2,9x13
x montaggio creste parafango
e protezioni posteriori scocche
VESPA

CRESTE PER FARO ANTERIORE

FRONT HEADLIGHT CRESTS



sviluppo arco mm.160



ART. **5267**
CROMATA / CHROMED
VESPA 125 DAL 1948 AL 1952 (FARO BASSO)

sviluppo arco mm.160



ART. **5269**
CROMATA / CHROMED
VESPA 125 DAL 1953 AL 1957 (FARO BASSO)
(Sim. 018215)

PARAFANGHI ANTERIORI

FRONT MUDGUARDS



ART. **5284**

IN FERRO / IRON

VESPA 50-90-125-PRIMAVERA ET3 ('67-'82)

(Sim. 1836806-91323)



ART. **5284-CARB**

IN FERRO **EFFETTO CARBONIO**
IRON, LOOK CARBONIO

VESPA 50-90-125 PRIMAVERA ET3 ('67-'82)

SALDATE RAVVICINATE
NEAREST WELDING



ART. **6158**

IN FERRO / IRON

VESPA PK 50 XL ('85-'88) - PK 125 XL ('86-'89)

VESPA PK XL PLURIMATIC 50 ('85-'90)

VESPA RUSH 50 ('88-'89)

(Sim. 2267546)



ART. **6156**

IN PLASTICA / PLASTIC

VESPA PK 50 / 125

(Sim. 215876)



ART. **6159**

IN PLASTICA / PLASTIC

VESPA FL 50-125-FL2-HP-N

(Sim. 911100 ex 256342)

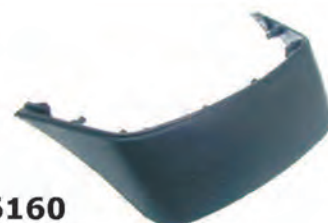

ART. **6160**

PARASPRUZZO
PER PARAFANGO ANTERIORE

FRONT MUDGUARD FLAP

VESPA FL 50-125-FL2-HP-N (Sim. 266308)



PARAFANGHI ANTERIORI FRONT MUDGUARDS



ART. **5283** IN FERRO / IRON
VESPA PX TUTTI TIPI / ALL MODELS
PXE ARCOBALENO 125-150-200 (1981-1997)
(Sim.1774976)



ART. **5283-FD** IN FERRO / IRON
VESPA PX 125-150-180 FRENO A DISCO / BRAKE DISC
(Sim.56381101)



ART. **5282**
IN FERRO / IRON
VESPA SUPER



**spessore lamiera mm.1 come originale
thickness sheet mm.1 as original**



ART. **5281**
IN FERRO / IRON
VESPA 1959/1960 2%
VESPA 125 DAL '59 (VNB1-2-3-4-5-6)
VESPA 150 DAL '60 (VBB1-VBB2)

ART. **5285**
IN FERRO, **CON RINFORZO**
IRON, WITH REINFORCEMENT
VESPA 150 SPRINT - RALLY 200
(Sim.120604)



ART. **5295**
PIASTRA RINFORZO
ATTACCO PARAFANGO
REINFORCEMENT SUPPORT
CONNECTION MUDGUARD
VESPA '59 (Sim.21815)



ART. **5285-S**
IN FERRO, **SENZA RINFORZO**
IRON, WITHOUT REINFORCEMENT
VESPA 150 SPRINT - GTR
(Sim.100820)

PARAFANGHI ANTERIORI

FRONT MUDGUARDS



ART. **7652**
PARAFANGO ANTERIORE IN PLASTICA
FRONT PLASTIC MUDGUARD
VESPA LX 50-125-150 - LXV 50-125
(Sim. 666528)



ART. **7654**
PARAFANGO ANTERIORE IN PLASTICA
FRONT PLASTIC MUDGUARD
VESPA GTS 125-150-250-300
(Sim. 651029)



ART. **7640**
PARAFANGO ANTERIORE IN PLASTICA
FRONT PLASTIC MUDGUARD
VESPA ET2 - ET4
(Sim. 8249005 ex 4270005)



ART. **7642**
PARASPRUZZO POSTERIORE IN PLASTICA
REAR PLASTIC FLAP
VESPA ET2 - ET4



RICAMBI FISSA PARAFANGHI

SPARE FOR FIXING MUDGUARDS



ART. **5290**

VITE FISSA PARAFANGO / SCREW FIXING MUDGUARD

VESPA TUTTI TIPI / ALL MODELS

(Sim. 253612)



ART. **5290-KT**

KIT VITE + DISTANZIALE + RONDELLE + DADO
PER FISSAGGIO LATERALE PARAFANGO

*KIT SCREW + SPACER + WASHERS + NUT
FOR FIXING LATERAL MUDGUARD*

VESPA 50-125 (1967-1982)

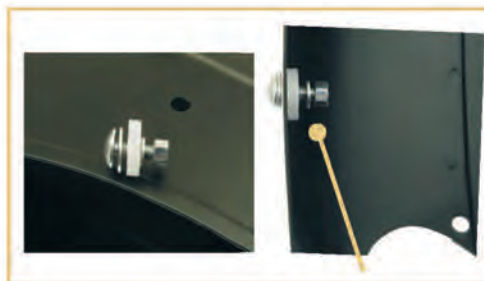

ART. **5291-KT**

KIT COMPLETO DI VITI M5x20
FISSA PARAFANGO

COMPLETE KIT, FIXING MUDGUARD

VESPA SMALL FRAME TUTTE / ALL



ART. **5294**

DISTANZIALE
Ø INTERNO mm. 6,2 - ESTERNO mm. 18 x h 4 mm
PER FISSAGGIO LATERALE PARAFANGO

*SPACER
Ø INTERNAL mm. 6,2 - EXTERNAL mm. 18 x h 4 mm
FOR FIXING LATERAL MUDGUARD*

VESPA 50-125 (1967-1982)

(Sim. 099335)

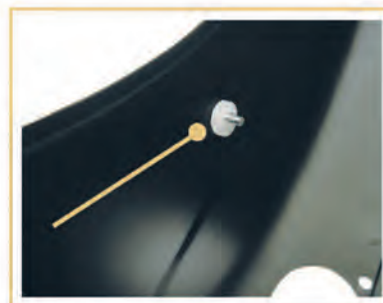

M5x15

ART. **3125-D15**

RONDELLA PIANA ZINCATA M5x15

SPECIFICA DA COLLOCARE SOTTO TESTA
VITE LATERALE PARAFANGO

COME MONTAGGIO ORIGINALE
(PROTEGGE LA VERNICE DEL PARAFANGO)

*GALVANIZED FLAT WASHER M5x15
SPECIFIC TO BE PLACED
LATERAL MUDGUARD UNDER HEAD SCREW*

AS ORIGINAL ASSEMBLY (PROTECTS THE MUDGUARD PAINT)

VESPA TUTTI TIPI / ALL MODELS

(Sim. 003055)



PROTEZIONI SCOCCA POSTERIORI

REAR PROTECTIONS



ART. 6200

PROTEZIONE SCOCCA POSTERIORE

VESPA PK 50 - 125 ('82-'84)
VESPA PK S 50/125 AUTOMATICA ('84-'89)
VESPA PK XL PLURIMATIC 50 ('85-'90)

(Sim. 199257)



ART. 6199

PROTEZIONE SCOCCA POSTERIORE

VESPA PK XL 50-125 - RUSH 50

(Sim. 9044005 ex 234411)

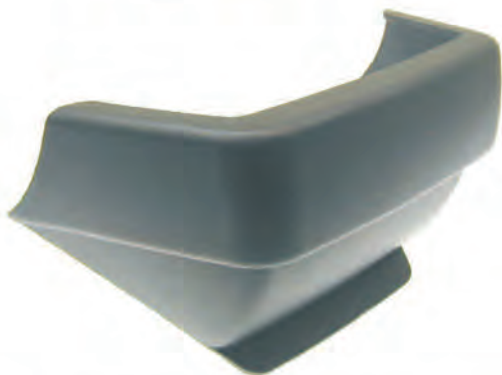

ART. 6198

PROTEZIONE SCOCCA POSTERIORE

VESPA FL2 - HP - N

(Sim. 256940)



ART. 6201

PARASPRUZZO POSTERIORE IN GOMMA

RUBBER REAR FLAP

VESPA PK - PK XL - VESPA FL2

(Sim. 199258)



ART. 6160

PARASPRUZZO PER PARAFANGO ANTERIORE

FRONT MUDGUARD FLAP

VESPA FL 50-125 - FL2 - HP - N

(Sim. 266308)



PROTEZIONI SCOCCA POSTERIORI

REAR PROTECTIONS



ART. **9219-P**

PROTEZIONE SCOCCA POSTERIORE

VESPA P125X - P150X - P200E

(Sim. 162105)



ART. **9220**

PROTEZIONE SCOCCA POSTERIORE

VESPA PX 125-150-200 ('98-'01)

VESPA PX EU2 125 ('01-'07)

VESPA PXE ARCOBALENO 125-150-200 ('81-'97)

(Sim. 219110)



ART. **10287**

MOLLA ELASTICA PER FISSAGGIO SCOCCA POSTERIORE

ELASTIC SPRING SEC REAR PROTECTION

VESPA PX PE - PX PE SR. ARCOBALENO

(Sim. 181475)

PORTA TARGA

LICENSE PLATE HOLDER

MODELLI VESPA CLASSIC - VECCHIE DIMENSIONI (mm.170x170)

VESPA CLASSIC MODEL - OLD DIMENSION (mm.170x170)



mm. 170

ART. **3280-C**

FONDO PORTA TARGA
IN FERRO CROMATO
VECCHIE DIMENSIONI
mm.170x170

LICENSE PLATE HOLDER,
CHROMED IRON
OLD DIMENSIONS mm.170x170



mm. 170

ART. **3280**

FONDO PORTA TARGA
IN FERRO VERNICIATO NERO
VECCHIE DIMENSIONI
mm.170x170

LICENSE PLATE HOLDER
BLACK PAINTED IRON
OLD DIMENSIONS mm.170x170



mm. 170

ART. **3277**

CORNICE TARGA IN FERRO CROMATO
VECCHIE DIMENSIONI **mm.170x170**

LICENSE PLATE RIM,
CHROMED IRON
OLD DIMENSIONS mm.170x170



mm. 170

ART. **3277-IX**

CORNICE TARGA INOX LUCIDATA
VECCHIE DIMENSIONI **mm.170x170**

HIGH QUALITY

LICENSE PLATE RIM, POLISHED INOX
OLD DIMENSIONS mm.170x170



mm. 170

ART. **3277-N**

CORNICE TARGA NERA
VECCHIE DIMENSIONI **mm.170x170**

HIGH QUALITY

LICENSE PLATE RIM, BLACK
OLD DIMENSIONS mm.170x170

MODELLI VINTAGE VERSIONE ORIGINALE

OLD VESPA MODEL ORIGINAL VERSION



ART. **3278**

PORTA TARGA
VESPA VECCHI MODELLI
VESPA 125 FINO AL 1962
VESPA 150 FINO AL 1961
(Sim. 018306)



ART. **3279**

PORTA TARGA RIALZATO
VECCHIE DIMENSIONI
VESPA 90 - 90SS
VESPA 125 PRIMAVERA - ET3
(Sim. 0704106)



ART. **3286**

PORTA TARGA IN ALLUMINIO
ALUMINIUM
VESPA GS 150 (VS1->VS5)
VESPA GS 160 (PRIMO TIPO/FIRST TYPE)

NB: ELENCO PORTA TARGA COMPLETO DA PAG. 217 A PAG. 221



KIT FREGI IN ALLUMINIO

ALUMINIUM TRIMS



ART. 5260

KIT FREGI IN ALLUMINIO
PER COFANI E PARAFANGO

HOODS AND MUDGUARD TRIM IN ALUMINIUM

(N.4 PZ. + VITI / SCREWS)

VESPA GS ('62-'64)

(SIM. 610099M)



ART. 5261

KIT FREGI IN ALLUMINIO
PER COFANI POSTERIORI

REAR HOODS TRIM IN ALUMINIUM

(N.2 PZ. + VITI / SCREWS)

VESPA 125 ('61-'64) - VESPA 150 ('61-'66)

(Sim.610097M)



ART. 5262

KIT FREGI IN ALLUMINIO
PER COFANI POSTERIORI E PARAFANGO

HOODS AND MUDGUARD TRIM IN ALUMINIUM

(N.4 PZ. + VITI / SCREWS)

VESPA GT 125 - GTR 125 - SPRINT 150
VESPA180 SS

(Sim.610100M)



ART. 5263

KIT FREGI IN ALLUMINIO
PER COFANI POSTERIORI E PARAFANGO

HOODS AND MUDGUARD TRIM IN ALUMINIUM

(N.4 PZ. + VITI / SCREWS)

VESPA GL 150

(Sim.610098M)



ART. 5259-V

VITE DI FISSAGGIO FREGI IN ALLUMINIO
PER COFANI - PARAFANGHI

*SCREW SEC. TRIM IN ALUMINIUM
FOR HOODS - MUDGUARDS*

BORDI SCUDO

SHIELD BEDING

ART. 10172-OR

BORDO SCUDO
IN ALLUMINIO
TIPO ORIGINALE

ALUMINIUM
ORIGINAL MODEL

VESPA 50 - 90
VESPA 125 PRIMAVERA
125 PRIMAVERA ET3

(Sim. 70416)



ART. 10169-OR

BORDO SCUDO
IN ALLUMINIO
TIPO ORIGINALE

ALUMINIUM,
ORIGINAL MODEL

VESPA 50 SS
VESPA 90 SS

(Sim. 101215)



ART. 10172

BORDO SCUDO
IN ALLUMINIO

ALUMINIUM

VESPA 50 - 90
VESPA 125 PRIMAVERA
VESPA 125 PRIMAVERA ET3

(Sim. 70416)



ART. 10173-OR

BORDO SCUDO
IN ALLUMINIO IN ALLUMINIO
TIPO ORIGINALE

ALUMINIUM,
ORIGINAL MODEL

VESPA PX 1ª SERIE

ADATTABILE A / SUITABLE TO:
VESPA 125 - 150
VESPA SPRINT - SUPER
VESPA GTR - GS - GL



ART. 15190

ATTREZZO VERSIONE COME ORIGINALE
PER APPLICAZIONE BORDO SCUDO IN ALLUMINIO

TOOL FOR ASSEMBLY ALUMINIUM SHIELD BEADING
VERSION AS ORIGINAL

VESPA (Sim. 003590-Y)



ART. 15190-R

SERIE RULLI RICAMBIO
PER ATTREZZO NS. ART. 15190

ROLLER SET
FOR TOOL CIF CODE 15190



BORDI SCUDO

SHIELD BEDING



ART. **10175**

BORDO SCUDO

IN MERAL

TIPO ORIGINALE
ORIGINAL MODEL

(SIM. 256938)

VESPA PK - PK XL - FL



ART. **10171**

BORDO SCUDO

ARGENTO / SILVER

(Sim. 192086)

VESPA PK 50
VESPA PK AUTOMATICA
VESPA PKS 50/80/125 cc.



ART. **10170-N**

BORDO SCUDO

IN MERAL
NERO / BLACK

TIPO ORIGINALE
ORIGINAL MODEL

(SIM. 226097)

VESPA PX PE - PX PE ARCOBALENO
VESPA 125 T5



ART. **10170**

BORDO SCUDO IN MERAL

CROMATO / CHROMED

TIPO ORIGINALE
ORIGINAL MODEL

(SIM. 574682)

VESPA PX PE
VESPA PX PE ARCOBALENO



ART. 10176

BORDO SCUDO (N.2 PZ.) IN ACCIAIO CROMATO / CHROMED STEEL

VESPA GS 150 (VS2/3/4/5)

(ADATTABILE A / SUITABLE TO: **VESPA GS 160**)

(Sim.610048M)

ART. 10178

BORDO SCUDO (N.2 PZ.) IN ACCIAIO CROMATO / CHROMED STEEL

VESPA RALLY 180-200 - VESPA 180 SS

(Sim.610048M001)



ART. 5541

SPORTELLO BAULETTO

TOP BOX DOOR

VESPA PK - PK AUTOMATICA
PKS 50/80/125 cc.

(Sim. 216467)



ART. 5542

PULSANTE APERTURA
SPORTELLO BAULETTO

TOP BOX DOOR BUTTON

VESPA PK - PK AUTOMATICA
VESPA PKS 50/80/125 cc.

(Sim. 216624)



ART. 6187

PORTA OGGETTI (SOPRA AL BAULETTO)

HOLDING OBJET (OVER THE TOP BOX)

VESPA PK - RUSH - N

(Sim. 248188)



BORDI SCUDO

SHIELD BEDING

VESPA LT - LX/LXV - S 2T/4T

LT 3V IE 4T 150 ('14) - LX 50 2T ('05-'13) - LX 50 4T ('05-'08) - LX 4T-4V 50 ('09-'13)
LX 2T TOURING 50 ('10-'13) - LX 125-150 ('05-'06) - LX EURO3 125-150 ('06-'08)
LX EU3 IE 125-150 (09-11)-LX 4T-4V TOURING 50 (10-13)-LX 4T 3V IE TOURING 125-150 (12-13)
LX 4T EU3 TOURING 125 (10-11)-LX TOURING 150 (10-12) - LX 4T FL 125-150 ('09)
LXV 50 2T ('06-'08) - LXV 50 2T NAVY ('08)-LXV 125 4T EU3 ('06-'08)-LXV 125 4T NAVY EU3 ('08)
LXV IE 4T 125 ('10-'13)-S 2T & COLLEGE 50 ('07-'12) - S 4T-4V 50 ('08-'09) - S 4T EU3 125 ('07-'08)
S 4T 3V IE 125 ('12) - S 4T & COLLEGE 125-150 ('09-'11) - S 4T 150 ('08-'09)

ART. **10177-SX** SINISTRO ARGENTO / SILVER LEFT (Sim.622187)
TIPO ORIGINALE / ORIGINAL MODEL

ART. **10177-DX** DESTRO ARGENTO / SILVER RIGHT (Sim.622188)
TIPO ORIGINALE / ORIGINAL MODEL

ART. **10177-SXN** SINISTRO NERO / BLACK LEFT
TIPO ORIGINALE / ORIGINAL MODEL

ART. **10177-DXN** DESTRO NERO / BLACK RIGHT
TIPO ORIGINALE / ORIGINAL MODEL

VESPA ET2 / ET4

ET2 50 ('97-05) - ET2 INIEZIONE 50 ('97-'00)
ET4 50 ('00-'05) - ET4 125 ('96-'98) - ET4 125-150 ('99-'02)

ART. **10174-SX** SINISTRO ARGENTO / SILVER LEFT (Sim.573002)
TIPO ORIGINALE / ORIGINAL MODEL

ART. **10174-DX** DESTRO ARGENTO / SILVER RIGHT (Sim.573001)
TIPO ORIGINALE / ORIGINAL MODEL

VESPA GRANTURISMO-GT-GTS-GTV

VESPA GRANTURISMO 125 ('03-'07)
GT EU3 125 ('06-'07) - GT 200 ('06-'07) - GT 60 EU3 250 ('06-'07)
GTS EU3 125 ('07-'12) - GTS 250 ('05-'14) - GTS ABS 250 ('05-'12)
GTS IE TOURING 300 ('11-'15) - GTS 4T IE SUPER 125 ('09-'15)
GTS SUPER IE 4T 3V 150 ('14-'15) - GTS SUPER 300 ('08-'15)
GTS SUPER SPORT 300 ('10-'13)
GTV 125 ('06-'08) - GTV 250 ('06-'09) - GTV 4T NAVY EU3 125-250 ('08)
GTV 4T 4V IE 300 ('10-'13) - GTV MONTENAPOLEONE 300 ('10)

ART. **10179-SX** SINISTRO ARGENTO / SILVER LEFT (Sim.577180)
TIPO ORIGINALE / ORIGINAL MODEL

ART. **10179-DX** DESTRO ARGENTO / SILVER RIGHT (Sim.577181)
TIPO ORIGINALE / ORIGINAL MODEL

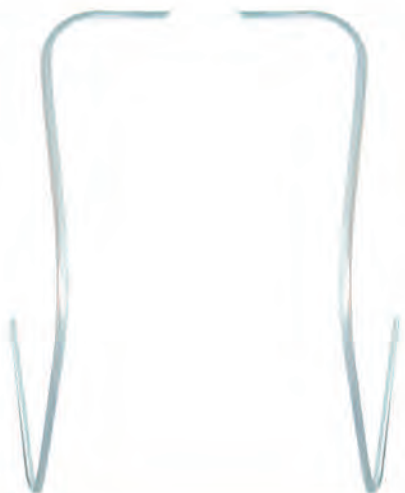

PIASTRINE

PLATES



ART. **10379-SX** PIASTRINA SINISTRA PER BORDO SCUDO ESTREMITA' INFERIORE (Sim.299964)
LEFT PLATE FOR SHIELD BEADING LOWER END

VESPA ET2 50 - ET2 INIEZIONE 50-ET4 50/125 - VESPA LT 4T
VESPA LX 2T/4T 50 - 4T LX 125/150 - LXV 2T/4T 50 - LXV 4T 125
VESPA S 2T/4T 50/125/150



ART. **10379-DX** PIASTRINA DESTRA PER BORDO SCUDO ESTREMITA' INFERIORE (Sim.299965)
RIGHT PLATE FOR SHIELD BEADING LOWER END

VESPA ET2 50 - ET2 INIEZIONE 50-ET4 50/125 - VESPA LT 4T
VESPA LX 2T/4T 50 - 4T LX 125/150 - LXV 2T/4T 50 - LXV 4T 125
VESPA S 2T/4T 50/125/150

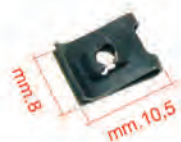

ART. **10374** PIASTRINA PER VITE AUTOFILETTANTE Ø mm. 2,9 (Sim.S8088)

PER FISSAGGIO CLACSON
PLATE FOR SELF-TAPPING SCREW FOR FIX HORN

VESPA 50-N-L-R - PRIMAVERA 125 - GL - SUPER 125-150-SS180
VESPA GT 125-SPRINT 150-RALLY 180-200 - T5 125

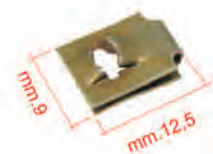

ART. **10375** PIASTRINA PER VITE AUTOFILETTANTE Ø mm. 3,5 (S.CM017403)

PER FISSAGGIO BORDO SCUDO INFERIORE
PLATE FOR SELF-TAPPING SCREW FOR FIX BOARD SHIELD LOWER END
VESPA LX - LX FL 2T/4T 50-125-150-VESPA S 2T/4T 50-125-150

APPLICAZIONI VARIE / VARIOUS APPLICATIONS:
BEVERLY-FLY-FREE-LYBERTY-NRG-SKIPPER-X9-ZIP - PORTER



ART. **10376** PIASTRINA PER VITE AUTOFILETTANTE Ø mm. 4,2 (CM017410-184142)
APPLICAZIONI VARIE

PLATE FOR SELF-TAPPING SCREW FOR VARIOUS APPLICATIONS:

BEVERLY-CARNABY-FLY-FREE-HEXAGON-LIBERTY-MP3-NRG-SFERA-SKIPPER
VESPA ET2-ET4-GRANTURISMO-GTS-GTV-LX-VESPA S 2T/4T-X EVO-X7-X8-X9
ZIP-TYPHOON - APE CALESSINO-CAR-MP601-POKER BENZINA/DIESEL



ART. **10377** PIASTRINA BRUNITA PER VITE AUTOFILETTANTE Ø mm. 4,2 (CM017409-185802)
APPLICAZIONI VARIE

PLATE FOR SELF-TAPPING SCREW FOR VARIOUS APPLICATIONS:

BEVERLY-CARNABY-FLY-LIBERTY-MP3-NRG - VESPA GRANTURISMO-GTS
VESPA LX-S 2T/4T-X EVO - X7 - X8 - X9 EVOLUTION-ZIP 2T/4T - APE TM D LCS

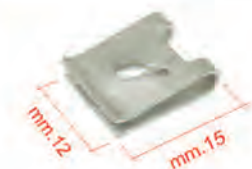

ART. **10373** PIASTRINA PER VITE AUTOFILETTANTE Ø mm. 4,8 (Sim.008112)

FISSA CUFFIA/COPRIVENTOLA
PLATE FOR SELF-TAPPING SCREW, SEC. FAN COVER
VESPA 50-90-125 PRIMAVERA-ET3 - PK



ART. **10378** PIASTRINA PER VITE PASSO M6 (Sim.254485)

PLATE FOR SCREW M6 FOR VARIOUS APPLICATIONS:

BEVERLY- CARNABY-DIESIS-FLY-FREE - HEXAGON - LIBERTY-MP3-NRG-NTT
SFERA-SKIPPER-SKR-VESPA GRANTURISMO - LX/LXV- S 2T/4T
X EVO-X7-X8-X9-ZIP-APE RST MIX - POKER BENZINA-TM D LCS PORTER



MASCHERINE COPRISTERZO

FRONT STEERING COVERS

VESPA 50 SPECIAL (V5A2) FINO AL 1972
VESPA 50 ELESTART (V5A3) FINO AL 1972



ART. **5878-N**

SOLO MASCHERINA NERA
ONLY BLACK STEERING COVER

(Sim.123222)

VESPA 50 - 90 - 125 PRIMAVERA
VESPA PRIMAVERA ET3 1ª serie



ART. **5878-G**

SOLO MASCHERINA GRIGIA
ONLY GREY STEERING COVER

(Sim.143593)

VESPA 50 SPECIAL (V5A2) FINO AL 1972 - 50 ELESTART (V5A3) FINO AL 1972
VESPA 50 - 90 - 125 PRIMAVERA - PRIMAVERA ET3 1ª SERIE



ART. **5878-CARB**

MASCHERINA **EFFETTO CARBONIO**
COMPLETA DI MODANATURA + SCUDETTO + MOLLETTE

STEERING COVER **LOOK CARBONIO**
COMPLETE WITH CREST + EMBLEM + CLAMPS

ART. **5878-MO**

MODANATURA PER MASCHERINA
COMPLETA DI SCUDETTO E MOLLE DI FISSAGGIO

CREST SET FRONT STEERING COVER, COMPLETE WITH CLAMPS AND EMBLEM

VESPA 50 - 90 - 125 PRIMAVERA - PRIMAVERA ET3 1ª SERIE
VESPA 50 SPECIAL (V5A2) FINO AL / TILL TO 1972
VESPA 50 ELESTART (V5A3) FINO AL / TILL TO 1972

(Sim.123576)



MASCHERINE COPRISERZO

FRONT STEERING COVERS

VESPA PK 50 (1982-1984) - PK 50 AUTOMATICA (1984-1989)



ART. **6191** SOLO MASCHERINA ONLY STEERING COVER (Sim.219564-214387)



ART. **5776** SCUDETTO / EMBLEM (Sim. 195577)

PIAGGIO

ART. **6102** TARGHETTA ADESIVA ADHESIVE NAME PLATE (Sim. 216719)

VESPA PK 50 XL 50 - 125 - RUSH 50



ART. **6192** SOLO MASCHERINA ONLY STEERING COVER (Sim.9007005 ex 226726)



ART. **5785** SCUDETTO / EMBLEM (Sim. 252970)

VESPA FL2 - N - HP



ART. **6193** SOLO MASCHERINA ONLY STEERING COVER (Sim.910000 EX 256344)



ART. **5785** SCUDETTO / EMBLEM (Sim. 252970)



MASCHERINE COPRISTERZO

FRONT STEERING COVERS

VESPA PX PE



ART. **5874-G** SOLO MASCHERINA
ONLY STEERING COVER

(Sim. 183779)



ART. **5783**

KIT TARGHETTA + SCUDETTO + VITE
NAMEPLATE KIT (NAMEPLATE+EMBLEM+SCREW)



ART. **5776**

SOLO SCUDETTO
ONLY EMBLEM

(Sim. 195577)



ART. **5874-CARB**

MASCHERINA **EFFETTO CARBONIO**
COMPLETA DI TARGHETTA + SCUDETTO + VITE

STEERING COVER, **LOOK CARBONIO**
COMPLETE WITH NAMEPLATE + EMBLEM + SCREW

MASCHERINE COPRISERZO

FRONT STEERING COVERS

VESPA PX PE ARCOBALENO - VESPA LML



ART. **5875-G** SOLO MASCHERINA
ONLY STEERING COVER
(Sim. 900400 ex 219118)



ART. **5876-G** GRIGLIA GRIGIA
GREY GRILL
(Sim. 564221-219119)



ART. **5876-CR** GRIGLIA CROMATA
CHROMED GRILL
(Sim. 564221)



ART. **5784** TARGHETTA ad incastro
ONLY NAMEPLATE
(Sim. 232895)



ART. **5785** SCUDETTO ad incastro
ONLY EMBLEM
(Sim. 252970)



VESPA 125 T5



ART. **10022** SOLO MASCHERINA
ONLY STEERING COVER (Sim.232893)



ART. **10023** GRIGLIA X MASCHERINA
GREY GRILL FOR STEERING COVER (Sim.232894)



ART. **5784** SOLO TARGHETTA ad incastro
ONLY PLASTIC NAMEPLATE (Sim. 232895)



ART. **5785** SOLO SCUDETTO ad incastro
ONLY EMBLEM (Sim. 252970)



MASCHERINE COPRISTERZO

FRONT STEERING COVERS

VESPA ET2 50 ('97-'05) - ET2 INIEZIONE 50 ('97-'00) - VESPA ET4 50 ('00-'05) - ET4 125 ('96-'02)



ART. **7680** SOLO MASCHERINA ONLY STEERING COVER (Sim.472200.5)



ART. **5785-R** SCUDETTO / EMBLEM VEICOLI FINO AL / VEHICLES TILL -> 1999 (Sim. 252970)



ART. **5782** SCUDETTO / EMBLEM VEICOLI DAL / VEHICLES SINCE 2000-> (Sim.576464)

VESPA LX 2T TOURING & 30 KM.50 ('10-'13)
VESPA LX 4T EU3 TOURING 125 ('10-'11) - TOURING 150 ('10-'12)



ART. **7682** SOLO MASCHERINA ONLY STEERING COVER (Sim.657588.5)



ART. **5782** SCUDETTO / EMBLEM (Sim.576464)

VESPA GTS 125-250-300 - VESPA GTV 125-250 - VESPA GT 60 EU3 250



ART. **7683** SOLO MASCHERINA ONLY STEERING COVER (Sim.621143)



ART. **5782** SCUDETTO / EMBLEM (Sim.576464)

MARCHIO ORIGINALE "BACHEL"
"BACHEL" ORIGINAL BRAND

CLACSON
HORNS



ART. 1950

CLACSON CROMATO 6V
CORRENTE ALTERNATA / ALTERNATING CURRENT

VESPA 50 (V5A1 '63->'67) (V5SS '66->'71)
VESPA 90 (V9A1 '63->'67) (V9SS '65->'71)
VESPA 125 (VNB 3/4 '61->'63)

(Sim. 093753)



ART. 1956

CLACSON 6V
CORRENTE ALTERNATA / ALTERNATING CURRENT

VESPA 50 S (V5SA1 '63->'68)
VESPA 90 (V9A1 '63->'68)
VESPA 125 PRIMAVERA (VMA2 '67->'83)
VESPA GT 125 (VNL2 '66->'73)
VESPA SUPER (VNC1 '66->'68)...

(Sim. 070300)



ART. 1957

CLACSON CROMATO 6V
CORRENTE ALTERNATA / ALTERNATING CURRENT

VESPA 50 (1965->1968)
VESPA SUPER 125-150
VESPA SPRINT 150 1ª SERIE
VESPA 150 (VBB2 1963->1965)

SENZA BATTERIA / WITHOUT BATTERY

(Sim. 097828)



ART. 1955

CLACSON CROMATO 6V
CORRENTE ALTERNATA / ALTERNATING CURRENT

VESPA 150 (VL3-VB1) 1956 -> 1957
SENZA BATTERIA / WITHOUT BATTERY

(Sim. 025714)



CLACSON
HORNS

MARCHIO ORIGINALE "BACHEL"
"BACHEL" ORIGINAL BRAND



ART. 1953

CLACSON NERO 6V

CORRENTE ALTERNATA - CON VITE DI REGISTRO
ALTERNATING CURRENT - WITH ADJUSTING SCREW

VESPA 125 (V1T ->V15T) - (V30T ->V33T) FINO AL 1952
SENZA BATTERIA / WITHOUT BATTERY

(Sim. 011635)



ART. 1954

CLACSON NERO 6V

CORRENTE ALTERNATA - SENZA VITE DI REGISTRO
ALTERNATING CURRENT - WITHOUT ADJUSTING SCREW

VESPA 125 - 150 (VM1/2-VUU1) 1953 -> 1957
SENZA BATTERIA / WITHOUT BATTERY

(Sim. 020250)



ART. 1952

CLACSON CROMATO 6V

CORRENTE ALTERNATA / ALTERNATING CURRENT

VESPA 150 (VBA DAL 1959 FINO AL TELAIO/FRAME VBA1T 76049)
SENZA BATTERIA / WITHOUT BATTERY

(Sim. 089840)



ART. 1951

CLACSON CROMATO 6V

CORRENTE CONTINUA / DIRECT CURRENT

VESPA GS 150 (VS2/3/4/5 DAL 1956 AL 1961)

VESPA GS 160 (VSB DAL 1962 AL 1964) CON BATTERIA / WITH BATTERY

VESPA 150 (VBA DAL VBA1T 76050)
VESPA 150 (VBB1T TUTTE/ALL)
VESPA GL (VLA1T TUTTE/ALL)

(Sim. 028249)

GUARNIZIONI CLACSON

HORN GASKETS



ART. 1920

GUARNIZIONE CLACSON

CON BORDO SMUSSATO / WITH BEVELED EDGE

VESPA 50 (V5A1T '63->'83) (V5SS1T '66->'71)
 VESPA 90 (V9A1T '63->'68) (V9SS1T '65->'71)
 VESPA 125 (VNB2T DAL/FROM 4718) -
 VESPA 150 (VBB1T DAL/FROM 32070)
 VESPA SUPER 125 ('66->'68) - SUPER 150 (66->'79)

(Sim. 92648)



ART. 1922

GUARNIZIONE CLACSON

SPESSORE / THICKNESS 4 mm.

VESPA 125 (VNB1->6 '60->'66)
 VESPA 150 (VL1T->3T '55->'56) - (VB1T '57->'58) -
 VESPA 150 (VBA1T '59->'60) - (VBB1T->2T '61->'66)
 VESPA GS 150 (VS1T->5T '55->'58)
 VESPA GS 160 (VSB1T '62->'64)



ART. 1925

GUARNIZIONE CLACSON NERA / BLACK

VESPA 125 PRIMAVERA - Et3

(Sim. 174091-120798)



ART. 1921

GUARNIZIONE CLACSON

CON BORDO SMUSSATO / WITH BEVELED EDGE

VESPA SUPER 125 (VNC1T '66->'68)
 VESPA GRAN TURISMO 150 (VNL2 DAL 30001 '66->'73)
 VESPA GL 150 (VLA1T '63->'64)
 VESPA 180 SS (VSC1T '65-<'68)
 VESPA SPRINT 150 ('65->'74) - SPRINT VELOCE ('69->'79)



ART. 1923

GUARNIZIONE CLACSON

SPESSORE / THICKNESS 2 mm.

VESPA 125
 (V15T '50) - (VM1/2T '53->'54) - (DAL V30T AL V33T '51->'52) - (VU1T)
 (VN1/2T '58->'59) - (VNA 1/2T '58->'59) - (VNB1>6T '60->'66)



RICAMBI PER CONTAKM.

SPEEDOMETERS SPAR PARTS



ART. **15220**

KIT CORNICETTA CROMATA + TRASPARENTE PER CONTAKM.
SPEEDOMETER TRANSPARENT + CHROMED RIM SET

VESPA 50 (V5S-V5SS) - VESPA 90 (V9SS)
VESPA 125 (VMA1/2T-VM91T-VNC1-VNL2/3)
VESPA 150 (VBC1) - RALLY 180-200

(Sim. 151837+100619)



ART. **15221**

KIT CORNICETTA CROMATA + TRASPARENTE PER CONTAKM.
SPEEDOMETER TRANSPARENT + CHROMED RIM SET

VESPA 125 (VNL2T) - VESPA 150 (VLB1T-VBB1T)
VESPA GL 150 - GS 150/160 - VESPA 180SS

(Sim. 084802+084803)



ART. **15222**

KIT CORNICETTA CROMATA + TRASPARENTE PER CONTAKM.
SPEEDOMETER TRANSPARENT + CHROMED RIM SET

VESPA 150 (Vb1)
VESPA GS 150 (VS1/2/3/4T)

(Sim. 024817+024818)





ART. **9121-E**

COMMUTATORE / SWITCH

VESPA PX PE - PX PE ARCOBALENO

(Sim.160743)



ART. **7240**

COPERCHIO FORO ALLOGGIO CONTAKM
SPEEDOMETER KMS COVER

VESPA 50

(SIM. 123678)



ART. **7240-CARB**

COPERCHIO FORO ALLOGGIO CONTAKM
SPEEDOMETER KMS COVER

EFFETTO CARBONIO / LOOK CARBONIO

VESPA 50



ART. **5273**

VITE CON DADO FISSA MANUBRIO
SCREW WITH NUT SEC. HANDLEBAR

VESPA TUTTI TIPI / ALL MODELS

(Sim. 70620)



COPERCHI MANUBRUIO

HANDLEBAR COVERS



ART. **8160**

COPERCHIO MANUBRIO

VESPA PX PE 1ª SERIE ('78-'82)
(Sim. 610368M ex 139829)



ART. **8160-CARB**

COPERCHIO MANUBRIO **EFFETTO CARBONIO**
LOOK CARBONIO

VESPA PX PE 1ª SERIE ('78-'82)



ART. **8154**

COPERCHIO MANUBRIO

2 FORI / HOLES

VESPA PX 1ª SERIE
SENZA LAMPEGGIATORI / WITHOUT FLASHERS

(Sim. 174014)



ART. **8162**

COPERCHIO MANUBRIO

VESPA PX 80 - 125 - 150 - 200 ARCOBALENO ('81-'97)

(Sim. 9046005-179731)

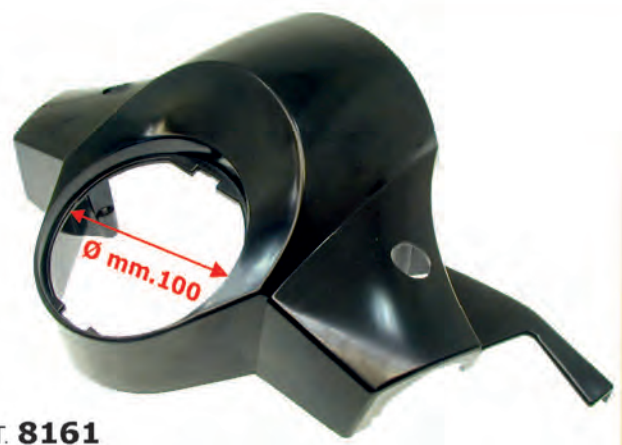

ART. **8161**

COPERCHIO MANUBRIO

VESPA PX 125 ('98-'01) - VESPA PX 125 ('11-'13)
VESPA PX 125 EU2 ('01-'07) - VESPA PX 150 ('11-'15)
VESPA PX 30 ANNI 125 ('07-'08)

(Sim. 6224306 - 581517)

COPERCHI MANUBRIO

HANDLEBAR COVERS

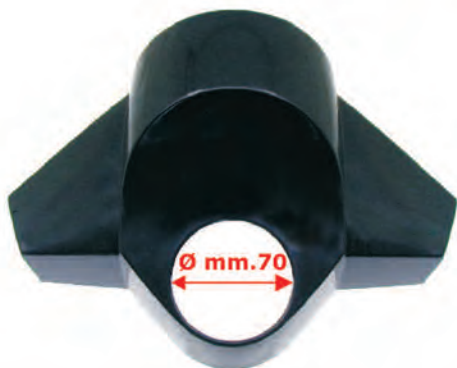

ART. **8157**

COPERCHIO MANUBRIO

VESPA PK 50-125 1ª SERIE

(Sim. 178637)

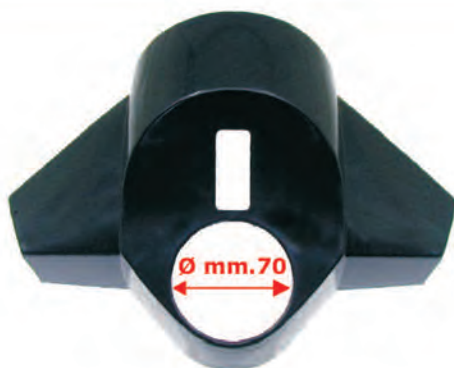

ART. **8163**

COPERCHIO MANUBRIO

VESPA PK 50 - 125 S

(Sim. 178933)



ART. **8158**

COPERCHIO MANUBRIO

VESPA PK 50 XL - PK 125 XL

(Sim. 226730)



ART. **8156**

COPERCHIO MANUBRIO

VESPA FL - FL2 - HP

(Sim. 921700)



COPERCHI MANUBRUIO

HANDLEBAR COVERS



ART. **8151**

COPERCHIO MANUBRIO

VESPA ET2 - ET4
LIBERTY 50 ('97-'05)
LIBERTY125 ('98-'02)

(Sim. 4272005)



ART. **8152**

COPERCHIO MANUBRIO

VESPA LX 2T 50 ('05-'13)
VESPA LX 2T TOURING 50 ('10-'13)
VESPA LX 4T 50 ('05-'09)
VESPA LX 4T-4V 50 ('09-'13)
VESPA LX 4T-4V TOURING 50 ('10-'13)
VESPA LX 125/150 ('05-'06)
VESPA LX EU3 125/150 ('06-'08)
VESPA LX EU3 IE 125/150 ('09-'11)
VESPA LX 4T FL 125/150 ('09)
VESPA LX 4T 3V IE TOURING 125/150 ('12-'13)
VESPA LX 4T EU3 TOURING 125 ('10-'11)
VESPA LX TOURING 150 ('10-'12)
VESPA LX 4T 3V IE 150 ('14)

(Sim. 652935)

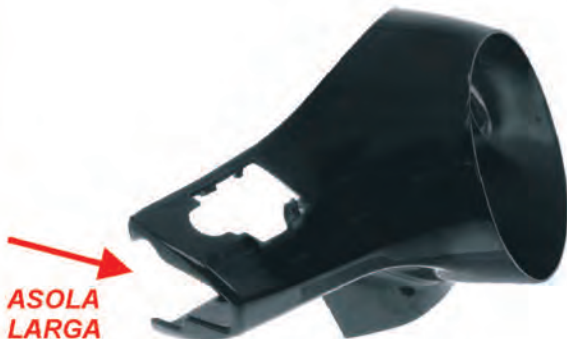

ART. **8155**

COPERCHIO MANUBRIO
(COLORE NERO / BLACK COLOUR)

VESPA GTS 300 ('14->)

ADATTABILE / SUITABLE :
VESPA GTS ABS 250 ('05-'12) TELAIO/FRAME 45101
VESPA GRANTURISMO 125 ('06-'07) TELAIO/FRAME M31101

STAFFE SUPPORTO SPECCHIO

MIRROR BRACKETS

VESPA 125 DAL '61 AL '66 (VNB3T->VNB6T) - **VESPA 150** (VB1) - (VBA-VBB1/2)
VESPA GS 150 - GS 160

STAFFE IN ACCIAIO SUPPORTO SPECCHIETTO CROMATA UNICO PEZZO **SENZA SALDATURE "VINTAGE NEW STYLE"**

MAGGIORE CAMPO RETRO VISIVO

CHROMED STEEL BRACKETS TO FIX MIRROR
 SINGLE PIECE **WITHOUT WELDING**
" VINTAGE NEW STYLE "
 MORE RANGE OF BACK VISION



ART. **20018**

STAFFA **DESTRA**
 RIGHT BRACKET

ART. **20016**

STAFFA **SINISTRA**
 LEFT BRACKET

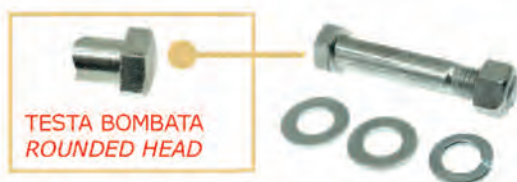

TESTA BOMBATA
 ROUNDED HEAD

ART. **20011-K**

KIT VITE MANUBRIO **MOD.ORIGINALE (CORTA mm. 55)**
 + DADO + RONDELLE

KIT, HANDLEBAR ORIGINAL MODEL SCREW (SHORT mm.55)

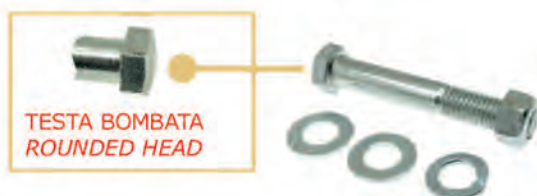

TESTA BOMBATA
 ROUNDED HEAD

ART. **20012-K**

KIT VITE MANUBRIO (**LUNGA mm. 65**) + DADO + RONDELLE
 PER APPLICAZIONE STAFFA FISSAGGIO SPECCHIO DESTRO/SINISTRO
 KIT, HANDLEBAR SCREW (LONG mm.65) + NUT + WASHERS
 FOR APPLICATION BRACKET FIX LEFT/RIGHT MIRROR



ART. **3110-ST**

DADO MODELLO ORIGINALE **STONDATO** - M10x1,5 - h9 - CHIAVE 14
 ZINCATO BIANCO PER VITE FISSA MANUBRIO

NUT ORIGINAL MODEL M10x1,5 - h9 - KEY 14
 WHITE ZINCED FOR SCREW FIX HANDLEBAR

(Sim.012030)



E

SPECCHI RETROVISORI

REAR VIEW MIRRORS

OMOLOGATI / APPROVED

CALOTTA Ø 115 mm.
body Ø 115 mm.



ART. **20255-SX** SINISTRO CROMATO
CHROMED LEFT

ART. **20255-DX** DESTRO CROMATO
CHROMED RIGHT

UNIVERSALE VESPA

CALOTTA Ø 115 mm.
body Ø 115 mm.



ART. **20253** SINISTRO E DESTRO CROMATO
CHROMED LEFT AND RIGHT

UNIVERSALE VESPA attacco allo scudo

CALOTTA Ø 115 mm.
body Ø 115 mm.

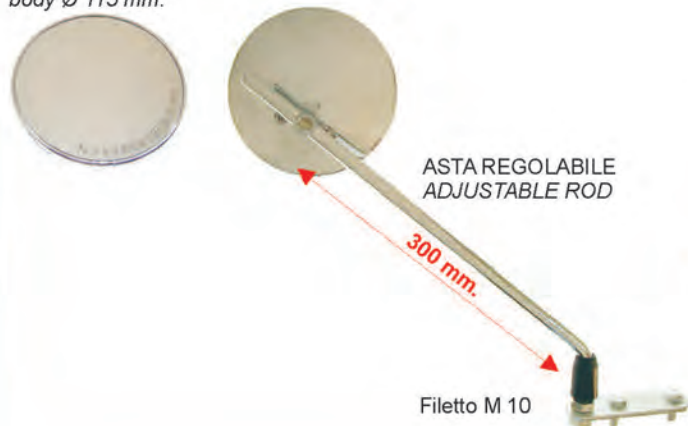

ART. **20251** SINISTRO / DESTRO CROMATO
CHROMED LEFT / RIGHT

UNIVERSALE VESPA

SPECCHI RETROVISORI

REAR VIEW MIRRORS



OMOLOGATI / APPROVED



ART. **20252** SINISTRO / DESTRO CROMATO
CALOTTA IN FERRO
CROMATURA 5 STRATI
*CHROMED LEFT / RIGHT
IRON BODY,
5 COATS CHROMIUM PLATING*

UNIVERSALE VESPA TUTTI I MODELLI

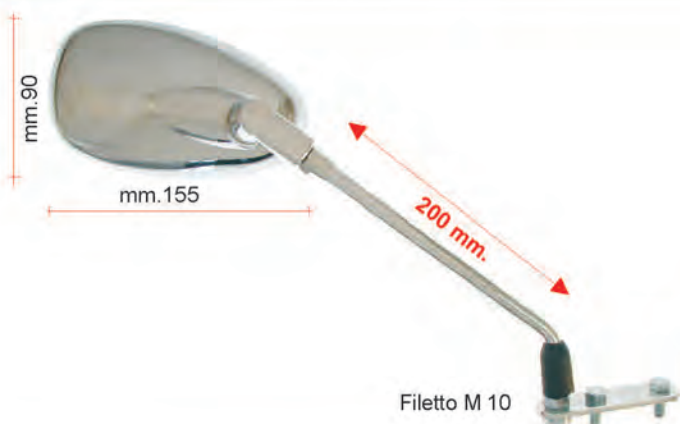

ART. **20254** SINISTRO / DESTRO CROMATO
CALOTTA IN FERRO,
CROMATURA 5 STRATI
*CHROMED LEFT / RIGHT
IRON BODY,
5 COATS CHROMIUM PLATING*

UNIVERSALE VESPA TUTTI I MODELLI

UNIVERSALE VESPA



ART. **20256**
SINISTRO / DESTRO NERO
BLACK LEFT / RIGHT



ART. **20256-CARB**
SINISTRO / DESTRO NERO **EFFETTO CARBONIO**
BLACK LEFT / RIGHT, **LOOK CARBONIO**

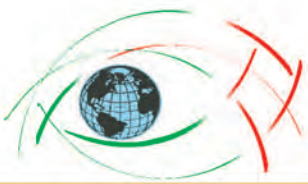

SERRATURE BLOCCASTERZO

SECURITY LOCKS ON THE STEERING

VESPA 50R - SS - SPECIAL - 90 SS - 125 PRIMAVERA - SUPER - SPRINT



ZADI



ART. **5643**

SERRATURA BLOCCASTERZO

MODELLO **CORTO** CON **GUIDA SOTTILE mm. 4**

SHORT MODEL - SLIM GUIDE mm. 4

(SIM. 120328)

VESPA 50 - 125 PRIMAVERA - PX 125/150 - SUPER - SPRINT - RALLY
APE 50 - TM P50 - FL/FL2 50 - 250 - MP P601 - MP 550



ZADI



ART. **5645**

SERRATURA BLOCCASTERZO

MODELLO **LUNGO** CON **GUIDA SOTTILE mm. 4**
CON PUNTALE IN ACCIAIO CONFORME AL MOD. ORIG

LONG MODEL - SLIM GUIDE mm. 4 - WITH STEEL TOE
CONFORMING WITH THE ORIGINAL MODEL.

VESPA 50S - R - ELESTART - 125 ET3 - PX PE



ZADI



ART. **5646**

SERRATURA BLOCCASTERZO

MODELLO **LUNGO** CON **GUIDA GROSSA mm.6**

LONG MODEL - BIG GUIDE mm. 6

(SIM. 139371)

SERRATURE BLOCCASTERZO

SECURITY LOCK ON THE STEERING

VESPA 125 VNA - VNB dal 1957 al 1965
VESPA 150 VBA - VBB dal 1959 al 1965



ART. **5642**

SERRATURA BLOCCASTERZO

(Sim. 82416)

VESPA 125 (1951-1957) - VESPA 150 (1954-1956)
VESPA GS 150 (VS1) 1955



ART. **5640-CO**

SERRATURA BLOCCASTERZO

PIASTRINA **CORTA** (PROFONDITA' DELLA PIASTRINA **mm. 20**)

SHORT PLATE (DEPTH OF THE PLATE mm. 20)

(SIM. 20456)

VESPA 150 (VB1) 1957-1958
VESPA GS 150 1956-1961



ART. **5640-LU**

PIASTRINA **LUNGA** (PROFONDITA' DELLA PIASTRINA **mm. 27**)

LONG PLATE (DEPTH OF THE PLATE mm.27)

(SIM. 060727)



SERRATURE

SECURITY LOCKS

VESPA N50 - PK 50 - PK 50/125 XL - RUSH - PX 125/150 - PX 30 ANNI 125 - PX Eu2
VESPA PXE ARCOBALENO - T5 125 - VESPA COSA CL/CLX - SCOOTER PIAGGIO-GILERA



ZADI



ART. **6211**

SERIE 1 CILINDRETTO + 2 CHIAVI

SET WITH No.1 CYLINDER + 2 KEYS

(Sim.196486)



ZADI



ART. **6210-3**

SERIE 3 CILINDRETTI + 2 CHIAVI

SET WITH No.3 CYLINDERS + 2 KEYS

(Sim.1792925)



ZADI



ART. **6210-5**

SERIE 5 CILINDRETTI + 2 CHIAVI

SET WITH No 5 CYLINDERS + 2 KEYS

VESPA PK FL



ZADI



ART. **6215**

SERIE 3 CILINDRETTI+2 CHIAVI

SET WITH No. 3 CYLINDERS + 2 KEYS

(Sim.265828)

ACCESSORI PER SERRATURE

SECURITY LOCK ACCESSORIES



ART. **5657**

COPERCHIETTO PER SERRATURA
SECURITY LOCK COVER
VESPA 50 - 125 - APE TM P 50 ('85-'89)

(Sim.174628)



ART. **5657-HQ**

COPERCHIETTO **CROMATO** PER SERRATURA
COMPLETO DI RIBATTINI
HIGH QUALITY
SECURITY LOCK **CHROMED** COVER
COMPLETE OF RIVETS
VESPA 50 - 125 - APE TM P 50 ('85-'89)

(Sim.174628)



ART. **5379-G**

RIBATTINO COPERCHIETTO SERRATURA
SECURITY LOCK COVER RIVET
VESPA 50 - 125 - APE TM P 50 ('85-'89)



ART. **5207**

COPERCHIETTO SERRATURA
SECURITY LOCK COVER
VESPA DAL 1965

(Sim. 70604)



ART. **5655-F**

PIASTRINA ELASTICA DI FERMO
PER SERRATURE BAULETTO
ELASTIC SPRING FOR TOOL BOX LOCKS
VESPA

(Sim. 73260)



ART. **5655-S**

MOLLA A SPIRALE PER SERRATURE STERZO
SPIRAL SPRING FOR SECURITY LOCKS
ON THE STEERING
VESPA - APE - CIAO - SI'

(Sim.152195)



ART. **G1713**

GUARNIZIONE BLOCCASTERZO
SECURITY LOCK GASKET
VESPA (FINO AL 1977) - VESPA 50N - L - R - SPECIAL
VESPA 50SS (V5SA1T) - 125 PRIMAVERA (VMA1T-2T)
VESPA SUPER (VNC1T) (VBC1T) - GT (VNL2T) - GTR (VNL2T)
VESPA TS (VNL3T) - VESPA GL (VLA1T)
VESPA SPRINT (VLB1T) - SPRINT VELOCE (VLB1T)
VESPA GS 160 (VSB1T 0055507->) - VESPA 180SS (VSC1T)
VESPA RALLY 180-200 (VSD1T - VSE1T)

(Sim.122296)



BLOCCHETTI ON-OFF

ON-OFF SWITCHES



ART. **6212** BLOCCHETTO ON-OFF

(Sim. 297777-178592)

VESPA N 50 (89-90) - PK 50-125 (82-84) - PK XL 50 (85-88) - PK XL 125 (86-89)
VESPA PKS 50-125 AUTOMATICA (84-89) - RUSH 50 - VESPA T5 125 (85-89)
VESPA PX 125-150-200 (98-01) - PX EU2 125 (01-02) - PXE ARCOBALENO 125-150-200 (81-97)
VESPA PX 30 ANNI 125 (07-08) - PX 125/150 (11-17)
APE FL-FL2 50 (89-95)

SCOOTER

PIAGGIO: HEXAGON 125-150 (94-97) - NRG 50 (94-96) - NRG EXTREME 50 (99-00) - NRG MC3 50 (01-04)
NRG PUREJET 50 (02-04) - NRG RST MC2 50 (96-98) - NTT 50 (95-96) - VELOFAX 50 (96-99)
ZIP 50 (92-96) - BIMODALE 50 (94-97) - F.R.50 (93-94) - F.R. RST 50 (96-97) - ZIP RST 50/SP 50 (96-00)

GILERA: EASY MOVING 50 (95-96)-STALKER 50 (97-08)-STALKER NAKED 50 (08)-STALKER SPEC.EDIT.(07-08)
STORM 50 - TYPHOON 50 (94-97/01-08) - X 50 (98-99)-XR 50 (2000) -125 (95-98)-X-XR 125 (99-00)



ART. **6213-P** BLOCCHETTO ON-OFF

(Sim.254536)

VESPA FL 50 (1990) - FL 125 (89-90) - FL2 AUTOMATICA 50 (90-91)
VESPA FL2 HP 50 (91-97) - VESPA COSA 2 125-150-200 (91-97)

SCOOTER PIAGGIO: FREE 50 (92-94)-FREE DELIVERY 50 (00-01) - FREE FL 50 (95-02)
SFERA 50 (91-93) - SKIPPER 125-150 (94-97)-SKR CITY 80 (1999)



ART. **6220** BLOCCHETTO ON-OFF

(Sim.1B002607-298581)

VESPA ET2 50 - ET2 INIEZIONE 50 - ET4 50/125
GRANTURISMO 125 (03-07) - GRANTURISMO 200 (06-07) - GRANTURISMO EU 3 125 (06-07)
GT 60 EU 3 250 (06-07) - GTS 250 (05-14) - GTS 4T IE SUPER 125 (09-16) - GTS ABS 250 (05-12)
GTS EU3 125 (07-12) - GTS IE & TOURING 300 (12-16) - IE TOURING 300 (11-12) - SUPER 300 (08-16)
GTS SUPER IE 4T 3V AU,EX,JP,RI,T,V 150 (14-15) - GTS SUPER SPORT 300 (10-13)
GTV 125/250 (06-09) - GTV 4T 4V IE 300 (10-13)-GTV 4T NAVY EU3 125 (08)-4T NAVY EU3 250 (07)
GTV VIA MONTENAPOLEONE 300 (2010)
VESPA LX 125/150 (05-06) - LX 2T 50 (05-13) - LX 2T TOURING & 30KM 50 (10-13) - LX 4T 50 (05-09)
LX 4T 3V IE - TOURING 125/150 (12-13) - LX 4T EU3 TOURING 125 8 (10-11) - LX 4T FL 125/150 (2009)
LX 4T-4V 50 (09-13) - LX 4T-4V TOURING 50 (10-13) - LX EU3 125/150 (06-08) - EU3 IE 125/150 (09-11)
LX TOURING 150 (10-12) - LXV 2T 50 (06-09) - LXV 2T NAVY 50 (2008) - LXV 4T EU3 125 (06-09)
LXV 4T NAVY EU3 125 (07-08) - LXV IE 4T 125 (10-13)
VESPA S 2T & COLLEGE 50 (07-12) - S 4T 150 (08-09) - S 4T EU 3 125 (07-08)
VESPA S 4T IE & COLLEGE 150 (09-12) - S 4T-4V & COLLEGE 50 (08-12)

SCOOTER

PIAGGIO: BEVERLY 125/250/500- BEVERLY 4T 350 - BEVERLY CRUISER 250/500 - BEV.TOURER 125/250/300/400
CARNABY 125/200/250 - CARNABY CRUISER 300 - FLY 50 2T/4T - FLY 100/125/150 (05-07) - FLY 4T MOT.CHN 50
HEXAGON GT-GTX 125/250 - LIBERTY 2T/4T 50- LIBERTY 125/200 - LIBERTY SPORT 2T/4T 50/125/150/200
LIBERTY ELETTRICO PPT AUT. -
X EVO 125/250/400 - X10 4T 4V IE EU3 125/350/500 - X7 EU3 125/250 - X7 EVO EU3 125/300
X8 125/200/250/400 - X8 PREMIUM EU2/EU3 -X8 STREET EU2 125/150 - X9 125/200/250/500
X9 AMALFI 180 - X9 EVOLUTION 125/200/250/500 X9 EVOLUTION ABS 500 - X9 EVOLUTION EU3 125
ZIP 50/125 - ZIP 2T/4T 50/100 - ZIP 4T 25KM-H 50 - ZIP 4T E4 50 - ZIP SP 50 - ZIP SP EU2 50

GILERA: ICE 50 - RUNNER 50 - RUNNER POGGIALI 50 - RUNNER PUREJET 50 - RUNNER SP 50
RUNNER FX-FXR 125-180 - RUNNER VX-VXR 125/180/200
TYPHOON 2T EU3 CH 50 (2011) - TYPHOON 2T EU2/EU4 50 - TYPHOON 4T 2V EU3 125 (10-11)

SERRATURE

SECURITY LOCK

VESPA 125 PRIMAVERA - PRIMAVERA ET3 - PX PE - SUPER - RALLY



ZADI



ART. **5653**

SERRATURA BAULETTO + COFANO
TOOL BOX AND HOOD SECURITY LOCK

(Sim. 139379)

VESPA 50R - 125 PRIMAVERA - P125X - P150S - SUPER 150 - RALLY 200



ZADI



ART. **5654**

BLOCCASTERZO + SERRATURA BAULETTO
CON UGUALE CHIAVE

STEERING + TOOL BOX SECURITY LOCKS SET
WITH THE SAME KEYS

(KIT COMPOSTO DA / SET COMPOSED OF : CIF. ART. 5645 + 5653)

VESPA 50S - R - ELESTART - 125 ET3 - PX PE



ZADI



ART. **5656**

BLOCCASTERZO + SERRATURA BAULETTO
CON UGUALE CHIAVE

STEERING + TOOL BOX SECURITY LOCKS
SET WITH THE SAME KEYS

(KIT COMPOSTO DA / SET COMPOSED OF : CIF ART. 5646 + 5653)



SERRATURE

SECURITY LOCKS

VESPA PX 125/150 - P200E (DAL 1978 AL 1984)

(guida sottile / *slim guide* mm.4)



ART. **5660**

TRIS SERRATURA

BLOCCASTERZO (**GUIDA SOTTILE mm.4**)
+ BAULETTO + SELLA
CON UGUALE CHIAVE

STEERING + TOOL BOX SECURITY + SADDLE LOCKS
SET WITH THE SAME KEYS

(Sim. 184860)

VESPA PX 125/150 - P200E 2ª SERIE

(guida grossa / *big guide* mm.6)



ART. **5660-G6**

TRIS SERRATURA

BLOCCASTERZO (**GUIDA GROSSA mm.6**)
+ BAULETTO + SELLA
CON UGUALE CHIAVE

STEERING + TOOL BOX SECURITY + SADDLE LOCKS
SET WITH THE SAME KEYS

VESPA 50 - 90 - 125 PRIMAVERA ET3



ART. **5650**

SERRATURA SPORTELLA LATERALE COMPLETA

LATERAL PANEL SECURITY LOCK

SERRATURE

SECURITY LOCK

VESPA PX PE ARCOBALENO DAL 1984 AL 2005



ART. **5665-N**
SERRATURA NERA PER BAULETTO
TOOL BOX LOCK, BLACK COLOUR
(Sim.198560)

NUOVA VESPA PX dal/since 2010 - LML STAR 125/150/200



ART. **5665-C**
SERRATURA CROMATA BAULETTO
TOOL BOX CHROMED LOCK



ART. **5651**
SERRATURA BAULETTO PORTAOGGETTI
LATERALE O POSTERIORE (Sim.025911)
TOOL BOX LOCK (LATERAL OR REAR)

DI PRIMO EQUIPAGGIAMENTO / FIRST EQUIPMENT:

LATERALE / LATERAL SIDE: VESPA 150 (VL3 - VBA - VBB1 - VBB2)
VESPA SPRINT 150 (VLB 1ª SERIE 025478)
VESPA GS 150 (VS2->VS5)
POSTERIORE / REAR : VESPA GS 160 (VSB1 SOLO / ONLY 1962)

ACCESSORIO PER TUTTI I MODELLI DI VESPA
PRODOTTI DAL 1946 AL 1965

ACCESSORY FOR ALL MODELS VESPA
MADE FROM 1946 TO 1965



SERRATURE SELLA

SADDLE SECURITY LOCKS

VESPA PX PE SERIE ARCOBALENO (PRIMO EQUIPAGGIAMENTO / FIRST EQUIPMENT)



ART. **5661**

SERRATURA COMPLETA PER SELLA

SADDLE LOCK

(Sim. 178887)

VESPA PX PE (1978-1983)



ART. **5658**

SERRATURA COMPLETA PER SELLA (**TIPO CORTO**)

SADDLE LOCK (**SHORT TYPE**)

(Sim. 437959 - 190013 - 161548)

VESPA 50 - 90 - PRIMAVERA ET3



ART. **5659**

SERRATURA COMPLETA PER SELLA (**TIPO LUNGO**)

SADDLE LOCK (**LONG TYPE**)

(Sim. 437958)



ART. **5668**

PERNO ANCORAGGIO SELLA
FILETTO mm. 7
LUNGHEZZA TOTALE mm. 73

SADDLE LOCK PIN
THREAD mm. 7
TOTAL LENGHT mm. 73

VESPA 50 - 125 PRIMAVERA - ET3
(Sim. 139318)



ART. **5670**

PERNO ANCORAGGIO SELLA
FILETTO mm. 7
LUNGHEZZA TOTALE mm. 44

SADDLE LOCK PIN
THREAD mm. 7
TOTAL LENGHT mm. 44

VESPA 50 - 125 PRIMAVERA - ET3
(Sim. 056729)



ART. **5667**

PERNO ANCORAGGIO SELLA
FILETTO mm. 8
LUNGHEZZA TOTALE mm. 45

SADDLE LOCK PIN
THREAD mm. 8
TOTAL LENGHT mm. 45

VESPA PX PE
(Sim. 240165- 161513)

HIGH QUALITY

TRASMISSIONI CONTAKM.

SPEEDOMETER TRANSMISSIONS

CAVO INTERNO IN ACCIAIO ASSEMBLATO IN BAGNO D'OLIO
GUAINA IN ACCIAIO, RIVESTITA IN PVC (TEMPERATURA DI ESERCIZIO da -25°C a +70°C)

STEEL INNER CABLE ASSEMBLED IN OIL BATH
STEEL SHEATH, COVERED IN PVC (OPERATING TEMPERATURE from -25°C to +70°C)



LG = LUNGHEZZA GUAINA / SHEATH LENGTH
LC = LUNGHEZZA CAVO / CABLE LENGTH

I valori riportati nei rispettivi descrittivi articolo si riferiscono alla lunghezza in millimetri di:
 LG quale lunghezza totale guaina come da disegno
 LC quale lunghezza cavo

The values reported in their descriptive items refers to the length in millimeters:
 LG which total length sheath as in the drawing
 LC which cable length

TRASMISSIONE COMPLETA

COMPLETE TRANSMISSION

ART. 5635-T (Sim. 71059)	VESPA 50 - 90 - 125 PRIMAVERA	 LC mm. 890 - LG mm. 850
ART. 5641-T (Sim.174161)	VESPA PX PE	 LC mm. 1025 - LG mm. 990
ART. 5637-T (Sim. 99011)	VESPA 125 GTR - SUPER - TS VESPA RALLY RUOTA / WHEEL 10"	 LC mm. 1070 - LG mm. 1030 (cavo grosso/big cable mm.2,7)
ART. 5638-TF	VESPA GS 150 ('55-'61) VESPA GL 150 ('63) RUOTA / WHEEL 10"	 LC mm. 1050 - LG mm. 1020 (cavo fine/fine cable mm.2)
ART. 5639-T	VESPA 125-150 ('63-'66) RUOTA / WHEEL 8"	 LC mm. 1000 - LG mm. 970 (cavo grosso/big cable mm.2,7)
ART. 5639-TF	VESPA 125 ('51-'62) VESPA 150 ('54-'62) RUOTA / WHEEL 8"	 LC mm. 1000 - LG mm. 970 (cavo fine/fine cable mm.2)



TRASMISSIONI CONTAKM.

SPEEDOMETER TRANSMISSIONS

HIGH QUALITY

CAVO INTERNO IN ACCIAIO ASSEMBLATO IN BAGNO D'OLIO
GUAINA IN ACCIAIO, RIVESTITA IN PVC (TEMPERATURA DI ESERCIZIO da -25°C a +70°C)
STEEL INNER CABLE ASSEMBLED IN OIL BATH
STEEL SHEATH, COVERED IN PVC (OPERATING TEMPERATURE from -25°C to +70°C)



TRASMISSIONE COMPLETA

COMPLETE TRANSMISSION

ART. 6172-T (Sim.195407)	VESPA ET3 125 - PK 50 - 125 ('82-'84) VESPA PK XL 50 ('85-'88) - PK XL 125 ('86-'89) VESPA PK XL RUSH 50 ('88-'89) - N 50 ('89-'90)	 LC mm. 940 - LG mm. 920
ART. 6171-T	VESPA PK	ATTACCO A GHIERA X CONTAKM. TIPO INDIANO RING CONNECTION FOR INDIAN SPEEDOMETER TYPE  LC mm. 940 - LG mm. 900
ART. 10111-T (Sim.266321)	VESPA FL 50 ('90) - FL 125 ('89-'90) VESPA FL2 AUTOMATICA 50 ('90-'91) VESPA FL2 HP 50 ('91-'97)	 LC mm. 965 - LG mm. 940
ART. 10110-T (Sim.229358-179271)	VESPA PX PE sr. ARCOBALENO VESPA PK 50 XL - P 125 ETS VESPA 125 T5	 LC mm. 1025 - LG mm. 1000
ART. 10590-T (Sim.229358)	VESPA COSA CL/CLX 125/150/200 ('88-'91) VESPA COSA2 125-150-200 ('91-'97) VESPA 125 T5 ('85-'89) PXE ARCOBALENO 125/150/200 ('81-'97)	 LC mm. 1050 - LG mm. 1030
ART. 10592-T (Sim. 601105)	VESPA PX 125-150-200 FRENO A DISCO VESPA PX 30 ANNI 125 ('07-'08)	 LC mm. 1000 - LG mm. 980
ART. 5634-T (Sim.56116R ex 561805)	VESPA ET2 50 ('97-'05) VESPA ET2 INIEZIONE 50 ('97-'00) VESPA ET4 50 ('00-'05) VESPA ET4 125-150 ('96-'02)	 LC mm. 1110 - LG mm. 1085
ART. 10595-T (Sim.649347 ex 601618 ex 56307R)	VESPA LX 2T 50-TOURING 50 ('05-'13) LX 125/150('05-'06) - LX EU3 125/150 ('06-'08) LX EU3 IE 125/150 ('09-'11) LX 4T 50 ('05-'08) - LX 4T-4V 50 ('09-'13) LX 4T 3V IE TOURING 125/150 ('12-'13) LX 4T FL 125/150 ('09) LX TOURING 150 ('10-'12)	 LC mm. 1105 - LG mm. 1070

HIGH QUALITY

TRASMISSIONI CONTAKM. SPEEDOMETER TRANSMISSIONS

CAVO INTERNO IN ACCIAIO ASSEMBLATO IN BAGNO D'OLIO
GUAINA IN ACCIAIO, RIVESTITA IN PVC (TEMPERATURA DI ESERCIZIO da -25°C a +70°C)

STEEL INNER CABLE ASSEMBLED IN OIL BATH
STEEL SHEATH, COVERED IN PVC (OPERATING TEMPERATURE from -25°C to +70°C)



TRASMISSIONE COMPLETA

COMPLETE TRANSMISSION

<p>ART. 10596-T (Sim.650838 ex 648122)</p>	<p>VESPA LXV 2T 50 ('06-'09) VESPA LXV 2T NAVY 50 ('08) VESPA LXV 4T EU3 125 ('06-'09) VESPA LXV 4T NAVY EU3 125 ('07-'08) LXV 4T 3V IE TOURING 125/150 ('12-'13) VESPA LXV IE 4T 125 ('10-'13)</p>	 <p>LC mm. 1095 - LG mm. 1065</p>
<p>ART. 10591-T (Sim.599350)</p>	<p>VESPA GRANTURISMO 125 ('03-'07) VESPA GRANTURISMO 200 ('06-'07) VESPA GRANTURISMO EU3 125 ('06-'07) VESPA GTS EU3 125 ('07-'08)</p>	 <p>LC mm. 1150 - LG mm. 1115</p>
<p>ART. 10597-T (Sim.651072)</p>	<p>VESPA GRANTURISMO EU3 125('06-'07) VESPA GTS EU3 125 ('07-'12)</p>	 <p>LC mm. 1150 - LG mm. 1120</p>
<p>ART. 9564-T (Sim.601321)</p>	<p>VESPA GTS 250 ('05-'14) VESPA GTS ABS 250 ('05-'12) VESPA GTS 4T IE SUPER 125 ('09-'14) VESPA GTS 4T IE SUPER 150 ('14) VESPA GTS SUPER 300 ('08-'14) VESPA GTS SUPER SPORT 300 ('10-'13) VESPA GTS IE TOURING 300 ('11-'12)</p>	 <p>LC mm. 1155 - LG mm. 1130</p>
<p>ART. 10598-T (Sim.650849)</p>	<p>VESPA GTS 250 ('05-'16) VESPA GTS SUPER IE 4T 125 ('09-'15) VESPA GTS SUPER IE 4T 3V 150 ('14-'15) VESPA GTS SUPER 300 ('08-'15) VESPA GTS SUPER IE 300 ('12-'14) VESPA GTS SUPER SPORT 300 ('10-'13) VESPA GTS IE TOURING 300 ('11-'15)</p>	 <p>LC mm. 1150 - LG mm. 1125</p>
<p>ART. 10599-T (Sim.650837 ex 649471 ex 648160)</p>	<p>VESPA GT 60 EU3 250 ('06-'07) VESPA GTV 125 ('06-'08) - GTV 250 ('06-'09) VESPA GTV 4T NAVY EU3 125 ('08) VESPA GTV 4T NAVY EU3 250 ('07) VESPA GTV 4T-4V IE 300 ('10-'13) VESPA GTV MONTENAPOLEONE 300 (10)</p>	 <p>LC mm. 1170 - LG mm. 1150</p>
<p>ART. 10594-T (Sim.650836 ex 649623)</p>	<p>VESPA S 2T & COLLEGE 50 ('07-'12) VESPA S 4T-3V IE 125 ('12) VESPA S 4T EU3 125 ('07-'08) VESPA S 4T 150 ('08-'09) VESPA S 4T IE & COLLEGE 125/150('09-'12)</p>	 <p>LC mm. 1110 - LG mm. 1090</p>



INGRANAGGI RINVIO CONTACTM.

SPEEDOMETER PINIONS

HIGH QUALITY



ART. 5672

(8 principi) (colore rosso)
(8 teeth) (red colour)

VESPA 50 - 90 - 125 PRIMAVERA ET3
VESPA PK 50 - PK 50 XL

(Sim. 151614)

ART. 5677-A

COPPIA INGRANAGGI
(8 principi + 10 principi)

PINIONS COUPLE
(8 teeth + 10 teeth)

VESPA 50 - 90 - 125 PRIMAVERA ET3
VESPA PK 50 - PK 50 XL

(Sim. 610360M)



ART. 6173

(12 principi) (colore rosso)
(12 teeth) (red colour)

VESPA PK 50 FL2 - PK 125
PK 125 XL - RUSH - N

(Sim.217128)



ART. 5662

12 principi x trasmissione con quadro **mm. 2**
12 teeth x transmission with fine connection mm.2

VESPA GS 160



ART. 5673

(12 principi) (colore bianco)
(12 teeth) (white colour)

VESPA PX PE fino al 1981

(Sim. 174048)

ART. 5663

12 principi x trasmissione con quadro **mm. 2,7**
12 teeth x transmission with connection mm.2,7

VESPA 180 SS



ART. 10112

(12 principi) (colore grigio)
(12 teeth) (grey colour)

VESPA PX PE SERIE ARCOBALENO
VESPA COSA

(Sim. 177508)



ART. 5678

(9 principi) (colore nero)
(innesto quadro **mm. 2,7**)

(9 teeth) (black colour)
(connection mm. 2,7)

VESPA GT 125- SPRINT 150
VESPA GL 150 - GS 150 ('59-'61)
VESPA RALLY 200

(Sim. 98652)

ART. 5679

(11 principi) (colore blu)
(innesto quadro **mm. 2,7**)

(11 teeth) (blue colour)
(connection mm. 2,7)

VESPA 125 (VNB5-VNB6)
VESPA 125 SUPER
VESPA 150 ('63-'66)

(Sim. 93525)



ART. 5676.09

(9 principi) (colore nero)
(innesto quadro **mm.2**)
QUADRO FINE - RUOTA 10"

(9 teeth) (black colour)
(fine connetion mm.2) - WHEEL 10"

VESPA GS 150 ('55->'61)
VESPA GL 150 ('63)

ART. 5676.11

(11 principi) (colore rosso)
(innesto quadro **mm.2**)
QUADRO FINE - RUOTA 8"

(11 teeth) (red colour)
(fine connetion mm.2) - WHEEL 8"

VESPA 125 (VNA-VNB '61>'62)
VESPA 150 (VBA-VBB '54>'62)

(Sim.83973)



HIGH QUALITY

CAVI E TRASMISSIONI GAS THROTTLE CABLES AND TRANSMISSIONS

GAS THROTTLE

ART. **8750**

CAVO INTERNO GAS
THROTTLE INNER CABLE

filo / wire \varnothing mm.1,2 x 2000
barilotto / pawl \varnothing mm.2,8 x 3

VESPA tutti modelli / all models



ART. **8755**

TRASMISSIONE GAS
THROTTLE TRANSMISSION

guaina / sheat \varnothing mm.4,5 x 1800

VESPA tutti modelli / all models



CAVO GAS VESPA "MODIFICATO" THROTTLE INNER CABLE "MODIFIED"

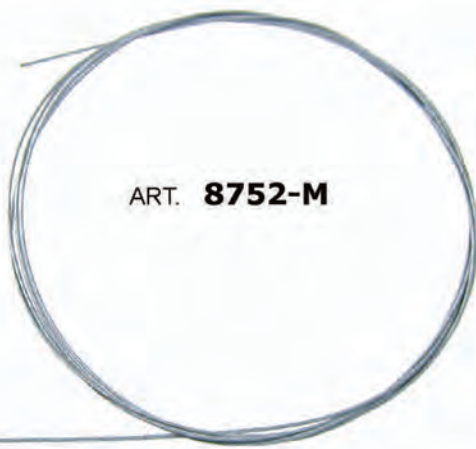

ART. **8752-M**

**!! SUGGERITO PER TUTTE LE VESPE
A PARTIRE DAL 1958 ...
... FINO ALLA VESPA PX SENZA MIX (COMPRESSE)
ECCEPTE VESPA 50 - 125 PRIMAVERA - ET3**

**!! SUGGEST IT FOR ALL KIND OF VESPA
SINCE 1958
... TO VESPA PX WITHOUT MIX (INCLUDED)
EXCEPT VESPA 50 - 125 PRIMAVERA - ET3**

ART. **8752-M**

CAVO GAS VESPA "MONTAGGIO AGEVOLATO"

SI UTILIZZA MONTANDO BARILOTTO FISSO
AL COMANDO GAS E MORSETTO AL CARBURATORE
(MORSETTO CIF ART.3548)

FILO \varnothing mm.1,2 x 2000

BARILOTTO fisso al comando gas \varnothing mm.5,5 x 6,5



THROTTLE INNER CABLE VESPA "EASY INSTALLATION"

USING FIXED PAWL ASSEMBLING TO THROTTLE SHIFT
AND CLAMP TO CARBURETOR (CLAMP CIF CODE 3548)

WIRE \varnothing mm. 1,2 x 2000

FIXED PAWL TO THROTTLE CONTROL \varnothing mm. 5,5x6,5



TRASMISSIONI STARTER STARTER TRANSMISSIONS

HIGH QUALITY

STARTER

ART. **8790**

TRASMISSIONE STARTER COMPLETA
lunghezza **guaina mm.147**

COMPLETE TRANSMISSION
sheat length mm.147

(Sim. 98221)

VESPA 50 - 90 - PK - PK XL - RUSH



ART. **8791**

TRASMISSIONE STARTER COMPLETA
lunghezza **guaina mm.130**

COMPLETE TRANSMISSION
sheat length mm.130

(Sim. 152391)

**VESPA 125 PRIMAVERA - 125 ET3
VESPA PK 125**



ART. **8792**

TRASMISSIONE STARTER COMPLETA
lunghezza **guaina mm.470**

COMPLETE TRANSMISSION
sheat length mm. 470

(Sim. 92370)

VESPA PX - RALLY - SPRINT



ART. **8793**

TRASMISSIONE STARTER COMPLETA
lunghezza **guaina mm.1490**

COMPLETE TRANSMISSION
sheat length mm. 1490

(Sim. 267084)

VESPA 50 V - 50 FL



HIGH QUALITY

CAVI E TRASMISSIONI CAMBIO GEAR CABLES AND TRANSMISSIONS

CAMBIO

GEAR

ART. **8770**

CAVO INTERNO CAMBIO

GEAR INNER CABLE

filo Ø mm.1,6 x 2000
barilotto Ø mm.5,5x6,5

VESPA TUTTI MODELLI / ALL MODELS

wire Ø mm.1,6 x 2000
pawl Ø mm.5,5x6,5



ART. **8771**

CAVO INTERNO CAMBIO RIGIDO

GEAR RIGID INNER CABLE

(Sim. 267644 - 265988)

VESPA 50V - 50 FL - 50 HP - COSA 2



ART. **8773**

TRASMISSIONE CAMBIO

GEAR TRANSMISSION

VESPA 50 HP - VESPA V

guaina rigida lunghezza mm. 1510
cavo rigido interno lunghezza mm. 1710

rigid sheat, lenght mm. 1510
inner rigid cable, lenght mm. 1710

CAVO e GUAINA RIGIDI
RIGID CABLE and SHEAT



ART. **8775**

TRASMISSIONE CAMBIO **CORTA**

GEAR TRANSMISSION **SHORT**

VESPA TUTTI MODELLI / ALL MODELS

guaina Ø mm. 4,5 x 1580
cavo interno Ø mm.1,6 x 1750
barilotto Ø mm. 5,5x6,5

sheat Ø mm. 4,5 x 1580 -
inner cable Ø mm.1,6 x 1750
pawl Ø mm. 5,5x6,5



ART. **8776**

TRASMISSIONE CAMBIO **LUNGA**

GEAR TRANSMISSION **LONG**

VESPA TUTTI MODELLI / ALL MODELS

guaina Ø mm. 4,5 x 1800
cavo interno Ø mm.1,6 x 2000
barilotto Ø mm.5,5x6,5

sheat Ø mm. 4,5 x 1800
inner cable Ø mm.1,6 x 2000
pawl Ø mm.5,5x6,5





CAVI E TRASMISSIONI FRIZIONE

CLUTCH CABLES AND TRANSMISSIONS

HIGH QUALITY

FRIZIONE

CLUTCH

ART. **8760**

CAVO INTERNO FRIZIONE
CLUTCH INNER CABLE

VESPA

filo Ø mm. 1,9 x 1800
barilotto sfilabile Ø mm 8x8
wire Ø mm. 1,9 x 1800
removable pawl Ø mm 8x8



ART. **8761**

CAVO INTERNO FRIZIONE
CLUTCH INNER CABLE

VESPA

filo Ø mm. 1,9 x 2000
barilotto sfilabile Ø mm 8x8
wire Ø mm. 1,9 x 2000
removable pawl Ø mm 8x8



ART. **8762**

CAVO INTERNO FRIZIONE
CLUTCH INNER CABLE

VESPA PK

filo Ø mm.1,9 x 1900
nipple Ø mm.6x8
wire Ø mm.1,9 x 1900
nipple Ø mm.6x8



ART. **8763**

CAVO INTERNO FRIZIONE
CLUTCH INNER CABLE

VESPA 50 V - 50 FL

filo Ø mm.2,5 x 1750
barilotto Ø mm.8x8
wire Ø mm.2,5 x 1750
pawl Ø mm.8x8



ART. **8765**

TRASMISSIONE FRIZIONE **CORTA**
CLUTCH TRANSMISSION **SHORT**

VESPA TUTTI MODELLI / ALL MODELS

guaina Ø mm.5 x 1560
cavo interno Ø mm.1,9 x 1800
barilotto sfilabile Ø mm. 8x8
sheat Ø mm.5 x 1560
inner cable Ø mm.1,9 x 1800
removable pawl Ø mm.8x8



ART. **8766**

TRASMISSIONE FRIZIONE **LUNGA**
CLUTCH TRANSMISSION **LONG**

VESPA TUTTI MODELLI / ALL MODELS

guaina Ø mm.5 x 1800
cavo interno Ø mm.1,9 x 2000
barilotto sfilabile Ø mm.8x8
sheat Ø mm.5 x 1800
inner cable Ø mm.1,9 x 2000
removable pawl Ø mm.8x8



HIGH QUALITY

CAVI E TRASMISSIONI FRENO BRAKE CABLES AND TRANSMISSIONS

FRENO

BRAKE

ART. **8761**

CAVO INTERNO FRENO **ANTERIORE**
FRONT BRAKE INNER CABLE

VESPA

filo Ø mm.1,9 x 2000
barilotto sfilabile Ø mm.8x8

wire Ø mm.1,9 x 2000
removable pawl Ø mm.8x8



ART. **8780**

CAVO INTERNO FRENO **POSTERIORE**
REAR BRAKE INNER CABLE

VESPA

filo Ø mm.2,5 x 900
senza barilotti

wire Ø mm.2,5 x 900
without pawls



ART. **8781**

CAVO INTERNO FRENO **POSTERIORE**
REAR BRAKE INNER CABLE

VESPA PX - PX ARCOBALENO - PK

filo Ø mm.3 x 900
tirante ad occhiello tipo originale

wire Ø mm.3 x 900
eyelet tie-rod original type



ART. **8782**

CAVO INTERNO FRENO **POSTERIORE**
REAR BRAKE INNER CABLE

VESPA PX - PX ARCOBALENO - PK

filo Ø mm.3 x 900
tirante ad occhiello stampato

wire Ø mm.3 x 900
printed eyelet tie-rod



ART. **8788**

TRASMISSIONE FRENO **ANTERIORE**
FRONT BRAKE TRANSMISSION

VESPA 125 T5 - PX PE ARCOBALENO 125-150-200

PER SOSTITUIRE SOLO IL CAVO UTILIZZARE
CAVO CIF 8761+REGOLO CIF 3596
TO REPLACE ONLY THE CABLE ONLY
USE CIF 8761 + ADJUSTMENT CIF 3596



ART. **8785**

TRASMISSIONE FRENO **POSTERIORE**
REAR BRAKE TRANSMISSION

VESPA PX - PX ARCOBALENO - PK

cavo tirante ad occhiello tipo originale
inner cable with eyelet tie-rod original type



ART. **8786**

TRASMISSIONE FRENO **POSTERIORE**
REAR BRAKE TRANSMISSION

VESPA PX - PX ARCOBALENO-PK

cavo tirante ad occhiello stampato
printed eyelet tie-rod



ART. **7128**

GOMMINO PROTEZIONE CAVO FRENO POSTERIORE
REAR BRAKE CABLE RUBBER PROTECTION

VESPA (Sim. 057321)



KIT TRASMISSIONI RESTAURO

RESTORATION TRANSMISSIONS SET

HIGH QUALITY



ART. 8720-KT

KIT **UNIVERSALE** PER RESTAURO **VESPA**
CAVI + MINUTERIA + GUAINA GRIGIA ALTA QUALITA'
IN ACCIAIO PIATTO + TUBETTO INTERNO TEFLON

UNIVERSAL KIT FOR VESPA
INNER CABLE + SMALL PARTS + GREY SHEAT "HIGH QUALITY"
IN STEEL PLATE + TEFLON INNER TUBE



ART. 8722-KT

KIT **SPECIFICO** PER RESTAURO **VESPA PX**
CON GUAINA GRIGIA - (TRASMISSIONI GIA' MONTATE)
(Composto da: 2 cambio+1 frizione+1 gas+1 starter+1 freno ant.+1 freno post.)

KIT SPECIFIC FOR VESPA PX
WITH: GREY SHEAT - (TRANSMISSIONS ALREADY ASSEMBLED)
(Composed of transmission: 2 gear+1 clutch+1 throttle+1 starter+1 front brake+1 rear brake)

ART. 8723-KT

KIT **SPECIFICO** PER RESTAURO **VESPA SPRINT - RALLY**
CON GUAINA GRIGIA - (TRASMISSIONI GIA' MONTATE)
(Composto da: 2 cambio+1 frizione+1 gas+1 starter+1 freno ant.+1 freno post.)

KIT SPECIFIC FOR VESPA SPRINT - RALLY
WITH: GREY SHEAT - (TRANSMISSIONS ALREADY ASSEMBLED)
(Composed of transmission: 2 gear+1 clutch+1 throttle+1 starter+1 front brake+1 rear brake)



GUAINA HIGH QUALITY
CON TUBETTO INTERNO "PHED" / WITH "PHED" INNER TUBE

SPIRALE ESTERNO	SPIRALE INTERNO	ESTERNO GUAINA PLASTIFICATA
SPIRAL EXTERNAL	SPIRAL INTERNAL	PLASTICIZED SHEATH EXTERNAL
∅ mm. 5	∅ mm. 2,8	∅ mm. 5,8

ART. 8721-G

GUAINA GRIGIA SPIRALE IN ACCIAIO PIATTA
TUBETTO INTERNO " PHED "
(FACILITA LO SCORRIMENTO DEL CAVO ALL'INTERNO DELLA GUAINA)
(MATASSINA DA 10 MT.)

GREY SHEAT - PLAIN STEEL SPIRAL
" PHED " INNER TUBE (EASY SLIDING CABLE IN THE SHEAT)
(ROLL OF 10 MT.)



ART. **3504** CAPOGUAINA
∅ interno / internal mm.6
∅ esterno / external mm.6,60



ART. **3514** BUSSOLETTA A GRADINO
∅ interno / internal mm.6,9
∅ esterno / external mm.8

HIGH QUALITY

GUAINA

SHEAT (VESPA - SCOOTER - CICLOMOTORI - MOTO)

SPIRALE ESTERNO / EXTERNAL SPIRAL Ø mm.4,5
SPIRALE INTERNO / INTERNAL SPIRAL Ø mm.2,5

ESTERNO GUAINA PLASTIFICATA Ø mm.5,2
 PLASTICIZED EXTERNAL SHEAT

ART. **4520-N**

NERA - LISCIA
 BLACK - SMOOTH

SPIRALE IN ACCIAIO
 STEEL SPIRED

(ROTOLO DA MT. 50 SCATOLATO)

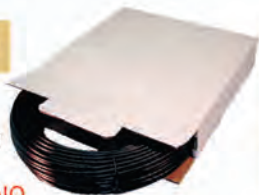

ART. **4520-G**

GRIGIA - LISCIA
 GREY - SMOOTH

SPIRALE IN ACCIAIO
 STEEL SPIRED

(ROTOLO DA MT. 50 SCATOLATO)



ART. **4520-Z**

GRIGIA
 GREY

QUADRETTATA
 SPIRALE IN ACCIAIO
 SQUARED, STEEL SPIRED

(ROTOLO DA MT. 50 SCATOLATO)



ART. **3502** CAPOGUAINA
 Ø interno / internal mm.5,5
 Ø esterno / external mm.6



ART. **3512** BUSSOLETTA A GRADINO
 Ø interno / internal mm.6,2
 Ø esterno / external mm.7

SPIRALE ESTERNO / EXTERNAL SPIRAL Ø mm.5
SPIRALE INTERNO / INTERNAL SPIRAL Ø mm.2,8

ESTERNO GUAINA PLASTIFICATA Ø mm.5,8
 PLASTICIZED EXTERNAL SHEAT

ART. **4521-N**

NERA - LISCIA
 BLACK - SMOOTH

SPIRALE IN ACCIAIO
 STEEL SPIRED

(ROTOLO DA MT. 50 SCATOLATO)

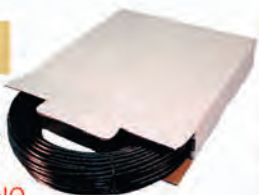

ART. **4521-G**

GRIGIA - LISCIA
 GREY - SMOOTH

SPIRALE IN ACCIAIO
 STEEL SPIRED

(ROTOLO DA MT. 50 SCATOLATO)



ART. **4521-Z**

GRIGIA
 GREY

QUADRETTATA
 SPIRALE IN ACCIAIO
 SQUARED, STEEL SPIRED

(ROTOLO DA MT. 50 SCATOLATO)



ART. **3504** CAPOGUAINA
 Ø interno / internal mm.6
 Ø esterno / external mm.6,60



ART. **3514** BUSSOLETTA A GRADINO
 Ø interno / internal mm.6,9
 Ø esterno / external mm.8

SPIRALE ESTERNO / EXTERNAL SPIRAL Ø mm.6
SPIRALE INTERNO / INTERNAL SPIRAL Ø mm.3,4

ESTERNO GUAINA PLASTIFICATA Ø mm.7
 PLASTICIZED EXTERNAL SHEAT

ART. **4522-N**

NERA - LISCIA
 BLACK - SMOOTH

SPIRALE IN ACCIAIO
 STEEL SPIRED

(ROTOLO DA MT. 50)



ART. **4522-G**

GRIGIA - LISCIA
 GREY - SMOOTH

SPIRALE IN ACCIAIO
 STEEL SPIRED

(ROTOLO DA MT. 50)



ART. **4522-Z**

GRIGIA
 GREY

QUADRETTATA
 SPIRALE IN ACCIAIO
 SQUARED, STEEL SPIRED

(ROTOLO DA MT. 50)



ART. **3506** CAPOGUAINA
 Ø interno / internal mm.7,2
 Ø esterno / external mm.8



ART. **3516** BUSSOLETTA A GRADINO
 Ø interno / internal mm.8,2
 Ø esterno / external mm.10



PIASTRE GUIDA CAVI AL MANUBRIO

HANDLEBAR CABLES GUIDE PLATES



ART. **5447** PIASTRA GUIDA CAVI AL MANUBRIO
HANDLEBAR CABLES GUIDE PLATE
VESPA 50 N-L-R (FARO TONDO)



ART. **5448** PIASTRA GUIDA CAVI AL MANUBRIO
HANDLEBAR CABLES GUIDE PLATE
VESPA 50 SPECIAL

RICAMBI PEDIVELLA AVVIAMENTO

STARTER PEDAL CRANKS SPARE PARTS



ART. **5971** GOMMINO PER LEVA AVVIAMENTO (Sim. 049642)
RUBBER FOR STARTER LEVER
VESPA TUTTI TIPI DAL 1959 AL 1985



ART. **5970** GOMMINO PER PEDIVELLA AVVIAMENTO (Sim. 241004)
RUBBER FOR KICK STARTER LEVER
VESPA PX PE -SPRINT - SUPER - RALLY



ART. **5111** VITE (M9 x 50) PER PEDIVELLA AVVIAMENTO (Sim. 00906)
BOLT FOR STARTER PEDAL CRANK
VESPA 50 - 90 - 125 PRIMAVERA - ET3 - PK



ART. **5096** VITE (M8 x 45) PER PEDIVELLA AVVIAMENTO
BOLT FOR STARTER PEDAL CRANK
VESPA PX



ART. **5098** VITE (M8 x 50) PER PEDIVELLA AVVIAMENTO
BOLT FOR STARTER PEDAL CRANK
VESPA PX

PEDIVELLE AVVIAMENTO

STARTER PEDAL CRANKS



ART. **5100**

COMPLETA CON VITE

COMPLETE WITH SCREW

VESPA 50 - 90 - 125 PRIMAVERA - ET3

(Sim. 79077)



ART. **5100-CARB**

EFFETTO CARBONIO - COMPLETA CON VITE

LOOK CARBONIO - COMPLETE WITH SCREW

VESPA 50 - 90 - 125 PRIMAVERA - ET3



ART. **6131**

COMPLETA CON VITE

COMPLETE WITH SCREW

VESPA PK 50 - PK 50 XL

VESPA PK 125 - PK 125 XL

VESPA RUSH - N

(Sim. 216141)



ART. **5105-HQ**

LUCIDATA e COMPLETA
DI BULLONE E GOMMINO

HIGH QUALITY

POLISHED AND COMPLETE
WITH BOLT AND RUBBER

VESPA PX PE

VESPA PX PE ARCOBALENO

(Sim 174312)



ART. **5105-CARB**

EFFETTO CARBONIO

COMPLETA DI BULLONE E GOMMINO

LOOK CARBONIO

COMPLETE WITH BOLT AND RUBBER

VESPA PX PE

VESPA PX PE ARCOBALENO





PEDIVELLE AVVIAMENTO

STARTER PEDAL CRANKS



ART. **5110**

LUCIDATA COMPLETA DI BULLONE E GOMMINO
POLISHED AND COMPLETE WITH BOLT AND RUBBER

VESPA RALLY 200
VESPA GS 160
VESPA 180 SS



ART. **5104**

LUCIDATA
COMPLETA DI BULLONE E GOMMINO
INNESTO A **MILLE RIGHE**
*POLISHED COMPLETE WITH BOLT AND RUBBER
THOUSAND LINES INSERTION*

VESPA 125 - 150 FINO AL / TILL TO 1958

(Sim. 174310)



ART. **5108**

LUCIDATA
COMPLETA DI BULLONE E GOMMINO
INNESTO A **5 RIGHE**
*POLISHED COMPLETE WITH BOLT AND RUBBER
FIVE LINES INSERTION*

VESPA 125-150
VESPA GL
VESPA SUPER
VESPA SPRINT DAL / SINCE 1959

(Sim. 150003)

INGRANAGGI AVVIAMENTO

STARTER GEARS



ART. **5003** INGRANAGGIO AVVIAMENTO **z 12 - 10** INNESTI - Ø INTERNO **mm. 20,5**

VESPA 50 - 90 - PRIMAVERA - ET3
VESPA PK E PK XL 50-125 - RUSH - N

(Sim. 78473)



ART. **5010** INGRANAGGIO AVVIAMENTO **z 12 - 12** INNESTI - Ø INTERNO **mm. 21,8**

VESPA P 125 X DAL '77 AL '82 (FINO AL TELAIO N. 146313)
VESPA P 150 X DAL '78 AL '81 (FINO AL TELAIO N. 264564)
VESPA 150 SPRINT - GTR - SUPER 150 - TS 125
VESPA GL

(Sim. 89229)



ART. **5011** INGRANAGGIO AVVIAMENTO **z 12 - 12** INNESTI - Ø INTERNO **mm. 20,5**

VESPA P 125 X ('77-'82) (DAL TELAIO N. 146314 IN POI)
VESPA P 150 X ('78-'81) (DAL TELAIO N. 264565 IN POI)
VESPA P 125 E ('81->) - P 200 E -PX PE SR. ARCOBALENO
VESPA 125 T5 - VESPA RALLY - VESPA COSA

(Sim. 113526)



ART. **5005** INGRANAGGIO AVVIAMENTO **z 12 - 14** INNESTI - Ø INTERNO **mm. 22**

VESPA 150 DAL '59 AL '61

(Sim. 89026)



ART. **5009** INGRANAGGIO AVVIAMENTO **z 12 - 13** INNESTI - Ø INTERNO **mm. 22**

VESPA 125 SUPER DAL '66 AL '68
VESPA 150 SUPER DAL '66 AL '79
VESPA P 150 S DAL '78 -->
VESPA 150 VBB1-VBB2

(Sim. 58680)



ART. **4990**

MOLLA
INGRANAGGIO AVVIAMENTO
STARTER GEAR SPRING

VESPA 50-125 ('67-'82)
VESPA 50-125 PRIMAVERA-ET3
VESPA PK-PK XL
VESPA RUSH - N
APE 50

(Sim. 151493)



ART. **4992**

MOLLA
INGRANAGGIO AVVIAMENTO
STARTER GEAR SPRING

VESPA PX - PE
VESPA PXE ARCOBALENO
VESPA T5
VESPA COSA

(Sim. 139100)



SETTORI AVVIAMENTO

STARTER SECTORS



ART. **5000** SETTORE AVVIAMENTO Nr. DENTI / COGS **z 11**

VESPA 50 - 50 L - 50 SS - 50 SPECIAL
VESPA HP 50 - N - FL - RUSH
VESPA 125 PRIMAVERA - ET3
VESPA PK 50/125-PK 50/125 XL-PK 50/80/100/125 S
VESPA P 125 ETS

(Sim. 78976)



ART. **5002** SETTORE AVVIAMENTO Nr. DENTI / COGS **z 10**

VESPA 50 S - 50 R
VESPA PK 50 SS
APE 50 - P50 - 50 FL - 250

(Sim. 79734)



ART. **5004** SETTORE AVVIAMENTO Nr. DENTI / COGS **z 10**

**INNESTO A MILLE RIGHE
THOUSAND LINES GRAFT**

VESPA 125/150 DAL 1958 AL 1964

(Sim. 53681)



ART. **5006** SETTORE AVVIAMENTO Nr. DENTI / COGS **z 10**

**INNESTO A 5 RIGHE
5 LINES GRAFT**

VESPA GL - VESPA SUPER - SPRINT
VESPA 180 RALLY - VESPA 125 T5

(Sim. 140920)



ART. **5007** SETTORE AVVIAMENTO Nr. DENTI / COGS **z 10**

VESPA P 80 X - P 125 X - P 150 X
VESPA P 150 S - VESPA P 200 E
VESPA PX PE SR. ARCOBALENO
VESPA COSA

(Sim. 148570)



ART. **10132**

MOLLA SETTORE AVVIAMENTO

VESPA PX 125/150 - PX E 150 (98-05)
PX 30 ANNI - PXE ARCOBALENO
T5 - SPRINT - SUPER RALLY - GR
GS 150 - COSA 2 - COSA CL-CLX

(Sim. 047218)

ART. **10134**

MOLLA SETTORE AVVIAMENTO

VESPA 50-125 (67-82) - VESPA 50-90 - PRIMAVERA - ET3
VESPA PK 50 - PK XL 50/125 - FL2 HP 50 - N - RUSH
APE P 50 (80-85)-APE TM P 50 (85-89)-50 FL3 EUROPA (96-99)

(Sim. 078478)



TAMPONI DI RISCONTRO

BUFFERS



ART. **5101**

TAMPONE DI RISCONTRO
PER SETTORE AVVIAMENTO

STARTER SECTOR STOP BUFFER

VESPA 50-90-125 PRIMAVERA
VESPA ET3 - PK

(Sim. 165206)



ART. **5101-XL**

TAMPONE DI RISCONTRO
PER SETTORE AVVIAMENTO

STARTER SECTOR STOP BUFFER

VESPA PK XL 50/125

(Sim. 078578)



ART. **5106**

TAMPONE DI RISCONTRO
PER SETTORE AVVIAMENTO

STARTER SECTOR STOP BUFFER

VESPA PX PE TUTTI TIPI /ALL MODELS

(Sim. 178338)

TESTE CILINDRO

CYLINDER HEADS



ART. **5430**

TESTA CILINDRO

VESPA 50 - 50S - 50SS - PK 50 - PK 50 S
APE 50

(Sim.2363915-112515)



ART. **5436**

TESTA CILINDRO

VESPA 125 PRIMAVERA - 125 ET3
APE 250

(Sim.112392)



ART. **5439**

TESTA CILINDRO

VESPA PX 125
VESPA SUPER
VESPA GTR - TS

(Sim. 90573)



ART. **5445**

TESTA CILINDRO

VESPA 150 SPRINT
VESPA PX 150 E

(Sim. 123474)





RACCORDI SCARICO

UNION EXHAUST PIPES



ART. **5046**

RACCORDO SCARICO
MAGGIORATO CON FORO Ø mm.8

(Sim.247033)

UNION EXHAUST PIPE (OVERSIZE)
WITH HOLE Ø mm. 8

VESPA 50 - 90 - 125 PRIMAVERA - ET3
VESPA PK 50 - PK 50 XL
VESPA HP - RUSH - N



ART. **6235**

RACCORDO SCARICO

(Sim.222208)

UNION EXHAUST PIPE

VESPA PK 125

GUARNIZIONI SCARICO

HEXAUST UNION PIPE GASKETS



ART. **5045-M**

GUARNIZIONE SCARICO **MAGGIORATA**
(CON FORI Ø mm. 8)

(Sim.112420
289008)

OVERSIZE GASKET (WITH HOLES Ø mm.8)

VESPA 50 - 125 PRIMAVERA - ET3
VESPA PK 50 - VESPA HP



ART. **5045-MA**

GUARNIZIONE SCARICO **IN ALLUMINIO MAGGIORATA**
(CON FORI Ø mm. 8)

ALUMINIUM OVERSIZE GASKET (WITH HOLES Ø mm.8)

VESPA 50 - 125 PRIMAVERA - ET3
VESPA PK 50 - VESPA HP



ART. **6237**

GUARNIZIONE SCARICO

(Sim.288838
222209)

VESPA PK 125 - PK 125 XL

PRIGIONIERI e VITI CARTER MOTORE

STUDS and CRANKCASE SCREWS

HIGH QUALITY



ART. **5047** FISSA RACCORDO SCARICO (M6x32) (Sim. 3918)
SEC. HEXAUST
VESPA 50-90-PRIMAVERA-ET3-PK 50

ART. **5050** FISSA CILINDRO / SEC. CYLINDER (M7x35) (Sim. 480)
VESPA 50-PK 50-PK 50 XL-APE 50-P50

ART. **5043** FISSA CILINDRO / SEC. CYLINDER (M7x140) (Sim.150656)
VESPA 50-90-125 PRIMAVERA-ET3
VESPA PK 125 - PK 125 XL-PX125/150
VESPA PXE ARCOBALENO - GTR 125
VESPA SUPER 150-SPRINT VELOCE 150

ART. **5051** FISSA CILINDRO / SEC. CYLINDER (M8x160) (Sim. 16058)
VESPA PE 200-RALLY 200
APE MP-CAR-TM

HIGH QUALITY



ART. **5043-KT**

**KIT PRIGIONIERI CILINDRO
COMPLETO DI DADI E RONDELLE**

STUD SEC.CYLINDER COMPLETE SET WITH NUTS AND WASHERS

VESPA 50 - 90 - 125 PRIMAVERA - ET3 - PK 125 - PK 125 XL
VESPA PX 125/150 - PXE ARCOBALENO
VESPA GTR 125 - SUPER 150 - SPRINT VELOCE 150

KIT COMPOSTO DA / SET COMPOSED OF :

Nr. 4 PRIGIONIERI CILINDRO	/ No. 4 STUDS SEC. CYLINDER
Nr. 4 RONDELLE GROWER	/ No.4 GROWER WASHERS
Nr. 4 RONDELLE	/ No. 4 WASHERS
Nr. 4 DADI	/ No. 4 NUTS

HIGH QUALITY



ART. **5028-KT**

**KIT VITI M7 CARTER MOTORE +
RONDELLE PIANE + RONDELLE GROWER + DADI**

**KIT OF ENGINE CRANKCASE SCREWS M7 + WASHERS + GROWER
WASHERS + NUTS**

VESPA 50-90-125 PRIMAVERA - ET3 - PK 50-PK 50S-PK 50 XL
VESPA RUSH - N - APE 50

HIGH QUALITY



ART. **5029-KT**

**KIT VITI M7 CARTER MOTORE +
RONDELLE PIANE + RONDELLE GROWER + DADI**

**KIT OF ENGINE CRANKCASE SCREWS M7 + WASHERS + GROWER
WASHERS + NUTS**

VESPA PX 125/150/200-PX PE-PX ARCOBALENO
VESPA SPRINT - RALLY - GTR



VITI CARTER - TAMPONI ELASTICI

CRANKCASE SCREWS - ENGINE ELASTIC BUFFER

HIGH QUALITY

VESPA 50-90-125 PRIMAVERA-ET3 - PK 50-PK 50S-50N - APE 50

ART. **3007-43** VITE **M7x43** - specifica per carter motore

ART. **3007-58** VITE **M7x58** - specifica per carter motore

ART. **3007-75** VITE **M7x75** - specifica per carter motore

ART. **3007-80** VITE **M7x80** - specifica per carter motore

VESPA PX - PX PE - PX ARCOBALENO - SPRINT - RALLY - GTR

ART. **3007-48** VITE **M7x48** - specifica per carter motore

ART. **3007-95** VITE **M7x95** - specifica per carter motore



ART. **5687**

TAMPONE ELASTICO LATO MOTORE

(Sim.112204)

ELASTIC BUFFER, ENGINE SIDE

VESPA 50 - 90 - 125 PRIMAVERA - ET3 - PK



ART. **5687-PX**

TAMPONE ELASTICO LATO MOTORE

(Sim.174724)

ELASTIC BUFFER, ENGINE SIDE

VESPA PX PE - PX PE ARCOBALENO 200 - RALLY 200

VESPA 50-90-125 PRIMAVERA-ET3-PK-PK XL-FL2-RUSH-N-HP



ART. **6620-KT**

KIT VITE-DADO-RONDELLA
PER ATTACCO MOTORE

KIT OF SCREW-NUT-WASHER FOR SEC ENGINE

ART. **6620**

BULLONE ATTACCO MOTORE / BOLT SEC. ENGINE

(Sim.78588)



ART. **6616**

DADO M10x1,5 h8 - CHIAVE 17
PER BULLONE ATTACCO MOTORE

NUT M10x1,5 h8 - KEY 17 - FOR SCREW SEC. ENGINE

(Sim.020110)



ART. **7238**

DISTANZIALE ATTACCO MOTORE AL TELAIO

(Sim.112093)

VESPA 50-125 ('67-'82)-PK 50 ('82-'84)-PK XL 50 ('85-'88)

VESPA RUSH 50 ('88-'89)-FL 50 ('90)-FL2 HP 50 ('91-'97)-N 50 ('89-'90)

VESPA 50 ('65->'66)
VESPA 50 SPECIAL
VESPA PK 50 1ª SERIE

CONO 19 mm.

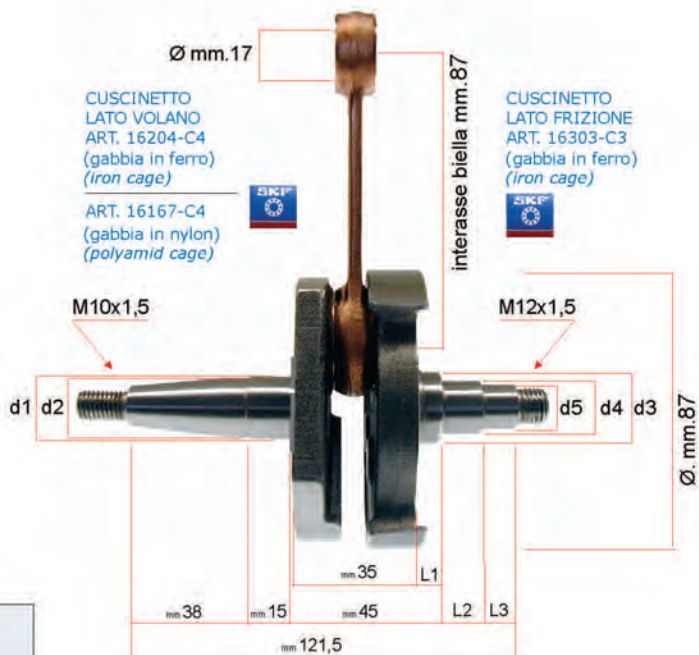

d1= \varnothing mm.20
 d2= \varnothing mm.19
 d3= \varnothing mm.22,5
 d4= \varnothing mm.17
 d5= \varnothing mm.14

L1= lunghezza mm.10
 L2= lunghezza mm.13
 L3= lunghezza mm.10,5

mazzucchelli

AMT 120

MODELLO ORIGINALE



ART. **5165**

MODELLO ORIGINALE
CORSA ORIGINALE mm. 43

ORIGINAL MODEL
ORIGINAL STROKE mm. 43



mazzucchelli

**VESPA 50 ('65->'66)
VESPA 50 SPECIAL
VESPA PK 50 1ª SERIE**

CONO 19 mm.



**ALBERI MOTORE
CRANKSHAFTS**

"Racing"

mazzucchelli

AMT 158

MODELLO ANTICIPATO **



ART. **5168**

BIELLA LUCIDA
ANTICIPATED MODEL
POLISHED CON-ROD

CORSA / STROKE mm. 43

mazzucchelli

AMT 184

MODELLO SUPER COMPETIZIONE **



ART. **5168-SC**

INTERAMENTE LUCIDO
BIELLA RINFORZATA HF
SUPER RACING MODEL
ALL POLISHED
REINFORCED HF CON-ROD

CORSA / STROKE mm. 43

mazzucchelli

AMT 158-DA

MODELLO DOPPIA ALIMENTAZIONE **



ART. **5168-DA**

BIELLA LUCIDA
DUAL POWER MODEL
POLISHED CON-ROD

CORSA / STROKE mm. 43

**ARTICOLO DESTINATO ALL'USO SU PISTA / ITEMS FOR USE ON TRACK

VESPA 125 PRIMAVERA - ET3
VESPA PK 125 1ª SERIE

CONO 19 mm.



d1= Ø mm.20
d2= Ø mm.19
d3= Ø mm.22,5
d4= Ø mm.17
d5= Ø mm.14

L1= lunghezza mm.10
L2= lunghezza mm.13
L3= lunghezza mm.10,5

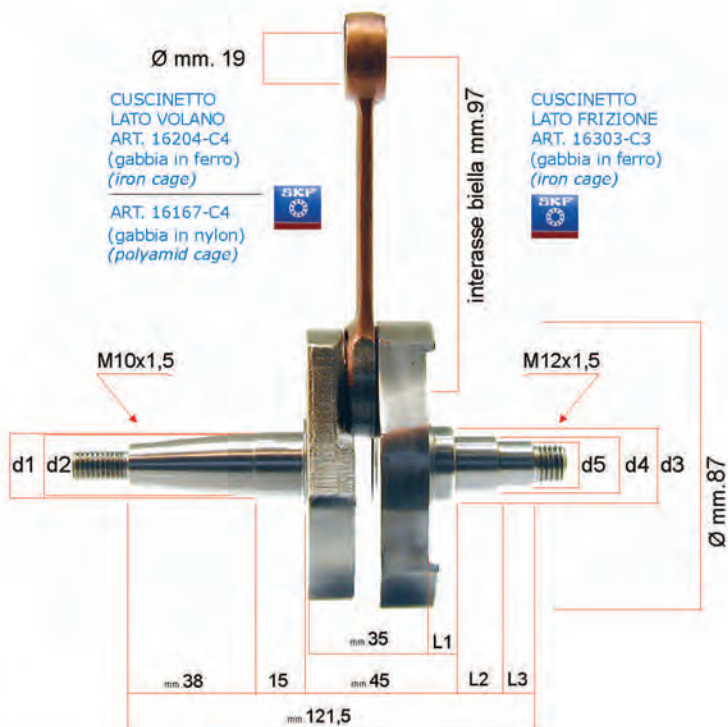

mazzucchelli

AMT 126

MODELLO ORIGINALE



ART. **5167**

MODELLO ORIGINALE

ORIGINAL MODEL

CORSA / STROKE mm. 51

mazzucchelli

AMT 160

MODELLO ANTICIPATO **



ART. **5169**

MODELLO ANTICIPATO
BIELLA LUCIDA

ANTICIPATED MODEL
POLISHED CON-ROD

CORSA / STROKE mm. 51

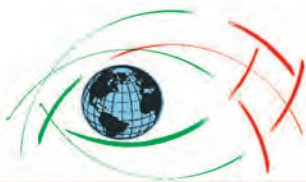

mazzucchelli

**VESPA 125 PRIMAVERA - ET3
VESPA PK 125 1ª SERIE**

CONO 19 mm.



**ALBERI MOTORE
CRANKSHAFTS**

"Racing"

mazzucchelli

AMT 182

MODELLO SUPER COMPETIZIONE **



sviluppo valvola mm.180



ART. **5169-SC**

MODELLO SUPER COMPETIZIONE
INTERAMENTE LUCIDO
BIELLA RINFORZATA HF

*SUPER RACING MODEL
ALL POLISHED
REINFORCED HF CON-ROD*

CORSA / STROKE mm. 51

mazzucchelli

AMT 160-DA

MODELLO DOPPIA ALIMENTAZIONE **



sviluppo valvola mm.200



ART. **5169-DA**

MODELLO DOPPIA ALIMENTAZIONE
BIELLA LUCIDA

*DUAL POWER MODEL
POLISHED CON-ROD*

CORSA / STROKE mm. 51

mazzucchelli

AMT 160-VT

MODELLO COMPETIZIONE VOLANI TONDI **



ART. **5169-VT**

MODELLO COMPETIZIONE
VOLANI TONDI
BIELLA LUCIDA

*RACING MODEL WITH
ROUND FLYWHEELS
POLISHED CON-ROD*

CORSA / STROKE mm. 51

Per l'applicazione necessita collettore lamellare con modifica carter sull'aspirazione o aspirazione sul cilindro con conseguente chiusura del foro aspirazione sul carter.
The application needs lamellar manifold with modified crankcase on the intake or intake on cylinder with resulting the closure of the hole intake on the crankcase.

**ARTICOLO DESTINATO ALL'USO SU PISTA / ITEMS FOR USE ON TRACK

VESPA PK 50 XL
VESPA HP - RUSH - FL2
APE TM 50 - APE 50 TL6

CONO 20 mm.



d1= Ø mm.20
d2= Ø mm.22,7
d3= Ø mm.17
d4= Ø mm.14

L1= lunghezza mm.9,5
L2= lunghezza mm.13
L3= lunghezza mm.11

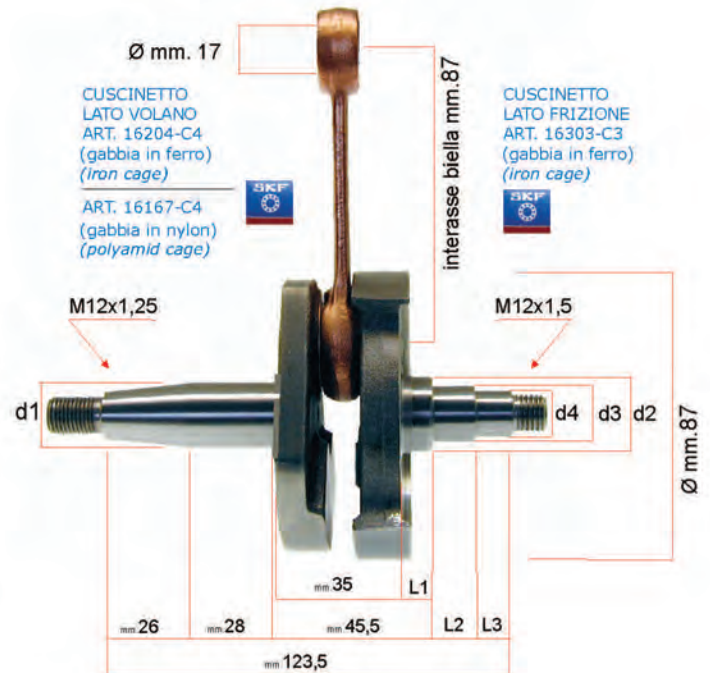

ART. **5163**

MODELLO ORIGINALE

ORIGINAL MODEL

CORSA/ STROKE mm. 43



mazzucchelli

**VESPA PK 50 XL
VESPA HP - RUSH - FL2
APE TM 50 - APE 50 TL6**

CONO 20 mm.



**ALBERI MOTORE
CRANKSHAFTS**

"Racing"

mazzucchelli

AMT 028

MODELLO ANTICIPATO

**



ART. **5164**

MODELLO ANTICIPATO
BIELLA LUCIDA

ANTICIPATED MODEL
POLISHED CON-ROD

CORSA / STROKE mm. 43

mazzucchelli

AMT 030

MODELLO SUPER COMPETIZIONE

**



ART. **5164-SC**

MODELLO SUPER COMPETIZIONE
INTERAMENTE LUCIDO
BIELLA RINFORZATA HF

SUPER RACING MODEL
ALL POLISHED
REINFORCED HF CON-ROD

CORSA / STROKE mm. 43

**ARTICOLO DESTINATO ALL'USO SU PISTA / ITEMS FOR USE ON TRACK

mazzucchelli



**PER TRASFORMAZIONE
da 50 cc. a 125 cc.**

FOR MODIFY from 50 cc. to 125 cc.

VESPA PK 50 XL - APE 50

CONO 20 mm.

ALBERI MOTORE

"Racing"



d1= Ø mm.20
d2= Ø mm.22,7
d3= Ø mm.17
d4= Ø mm.14

L1= lunghezza mm.9,5
L2= lunghezza mm.13
L3= lunghezza mm.11

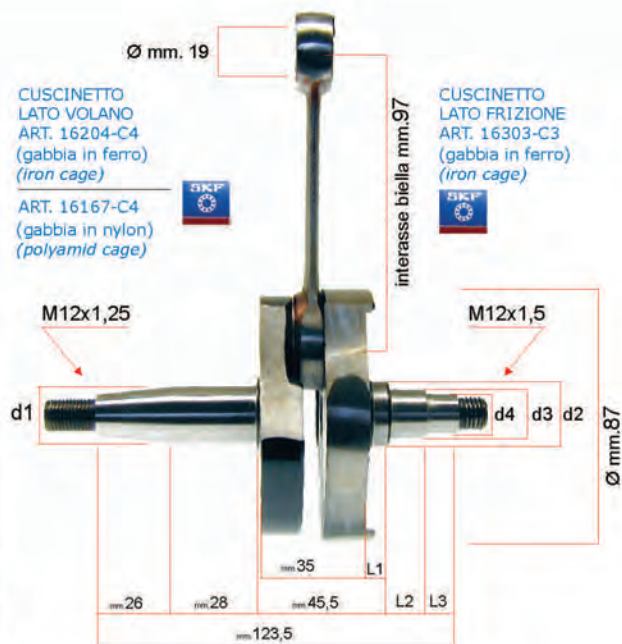

mazzucchelli

MODELLO ANTICIPATO **

AMT 186



ART. **5162**

MODELLO ANTICIPATO
BIELLA LUCIDA

ANTICIPATED MODEL
POLISHED CON-ROD

CORSA / STROKE mm. 51

mazzucchelli

MODELLO SUPER COMPETIZIONE **

AMT 188



ART. **5162-SC**

MODELLO SUPER COMPETIZIONE
BIELLA RINFORZATA HF

ANTICIPATED MODEL
REINFORCED HF CON-ROD

CORSA / STROKE mm. 51

mazzucchelli

MODELLO COMPETIZIONE VOLANI TONDI **

AMT 186-VT



ART. **5162-VT**

MODELLO COMPETIZIONE
VOLANI TONDI
BIELLA RINFORZATA HF

RACING MODEL WITH
ROUND FLYWHEELS
REINFORCED HF CON-ROD

CORSA / STROKE mm. 51

Per l'applicazione necessita collettore lamellare con modifica carter sull'aspirazione o aspirazione sul cilindro con conseguente chiusura del foro aspirazione sul carter.
The application needs lamellar manifold with modified crankcase on the intake or intake on cylinder with resulting the closure of the hole intake on the crankcase.

**ARTICOLO DESTINATO ALL'USO SU PISTA / ITEMS FOR USE ON TRACK



mazzucchelli

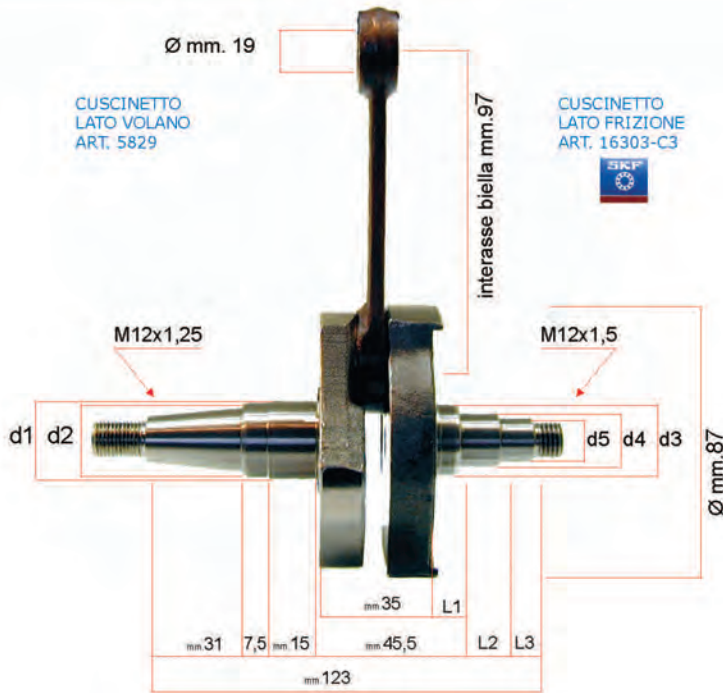

VESPA PK 125 XL

ALBERI MOTORE
CRANKSHAFTS

d1= Ø mm.20
d2= Ø mm.22,7
d3= Ø mm.17
d4= Ø mm.14

L1= lunghezza mm.9,5
L2= lunghezza mm.13
L3= lunghezza mm.11



mazzucchelli

MODELLO ORIGINALE

AMT 174



ART. **10140**

MODELLO ORIGINALE

ORIGINAL MODEL

CORSA / STROKE mm. 51

mazzucchelli

MODELLO ANTICIPATO **

AMT 176



ART. **10142**

MODELLO ANTICIPATO
BIELLA LUCIDA

ANTICIPATED MODEL
POLISHED CON-ROD

CORSA / STROKE mm. 51

mazzucchelli

MODELLO SUPER COMPETIZIONE **

AMT 178



ART. **10142-SC**

MODELLO SUPER COMPETIZIONE
INTERAMENTE LUCIDO
BIELLA RINFORZATA HF

SUPER RACING MODEL
ALL POLISHED
REINFORCED HF CON-ROD

CORSA / STROKE mm. 51

**ARTICOLO DESTINATO ALL'USO SU PISTA / ITEMS FOR USE ON TRACK

mazzucchelli



VESPA PX 125 - 150

**ALBERI MOTORE
CORSA ORIGINALE mm.57**



d1= Ø mm.25
d2= Ø mm.24
d3= Ø mm.31
d4= Ø mm.25
d5= Ø mm.15

L1= lunghezza mm. 7
L2= lunghezza mm.11,5
L3= lunghezza mm.25

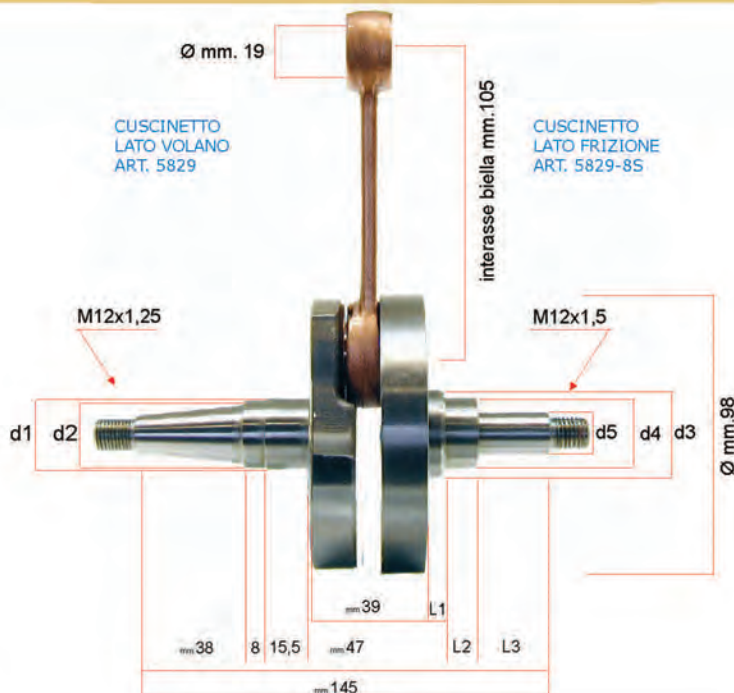

mazzucchelli

MODELLO ORIGINALE (CORSA mm.57)

AMT 154

sviluppo valvola mm.210



ART. **5180**

MODELLO ORIGINALE

ORIGINAL MODEL

CORSA ORIGINALE mm. 57
ORIGINAL STROKE mm. 57

mazzucchelli

MODELLO ANTICIPATO (CORSA mm.57) **

AMT 162

sviluppo valvola mm.200



ART. **5180-A**

MODELLO ANTICIPATO
BIELLA LUCIDA

ANTICIPATED MODEL
POLISHED CON-ROD

CORSA ORIGINALE mm. 57
ORIGINAL STROKE mm. 57

mazzucchelli

MOD. COMPETIZIONE VOLANI TONDI (CORSA mm.57) **

AMT 162-VT



ART. **5180-VT**

MODELLO COMPETIZIONE
BIELLA LUCIDA

RACING MODEL WITH
ROUND FLYWHEELS
POLISHED CON-ROD

CORSA ORIGINALE mm. 57
ORIGINAL STROKE mm. 57

Per l'applicazione necessita collettore lamellare con modifica carter sull'aspirazione o aspirazione sul cilindro con conseguente chiusura del foro aspirazione sul carter.
The application needs lamellar manifold with modified crankcase on the intake or intake on cylinder with resulting the closure of the hole intake on the crankcase.

**ARTICOLO DESTINATO ALL'USO SU PISTA / ITEMS FOR USE ON TRACK



mazzucchelli

VESPA PX 125 - 150

**ALBERI MOTORE
CRANKSHAFTS**

"Racing"

CORSA LUNGA mm.60



mazzucchelli

AMT 162-M

MODELLO ANTICIPATO (CORSA mm.60) **

sviluppo valvola mm.200



ART. **5180-CLA**

MODELLO ANTICIPATO
BIELLA LUCIDA
ANTICIPATED MODEL
POLISHED CON-ROD

**CORSA LUNGA mm.60
LONG STROKE mm.60**

mazzucchelli

AMT 162-MK

MODELLO ANTICIPATO (CORSA mm.60) MATERIALE K2D **

sviluppo valvola mm.200



ART. **5180-CLK**

MODELLO ANTICIPATO
BIELLA LUCIDA
ANTICIPATED MODEL
POLISHED CON-ROD

**CORSA LUNGA mm.60
LONG STROKE mm.60**

**REALIZZATO IN MATERIALE K2D
PER SOLLECITAZIONI AGONISTICHE**

mazzucchelli

AMT 162-MVT

MOD. COMPETIZIONE VOLANI TONDI (CORSA mm.60) **



ART. **5180-CLVT**

MODELLO COMPETIZIONE
VOLANI TONDI
BIELLA LUCIDA

**RACING MODEL WITH
ROUND FLYWHEELS
POLISHED CON-ROD**

**CORSA LUNGA mm.60
LONG STROKE mm.60**

Per l'applicazione necessita collettore lamellare con modifica carter sull'aspirazione o aspirazione sul cilindro con conseguente chiusura del foro aspirazione sul carter.
The application needs lamellar manifold with modified crankcase on the intake or intake on cylinder with resulting the closure of the hole intake on the crankcase.

**ARTICOLO DESTINATO ALL'USO SU PISTA / ITEMS FOR USE ON TRACK

mazzucchelli



VESPA PE 200

**ALBERI MOTORE
CRANKSHAFTS**

CORSA ORIGINALE mm.57



d1= Ø mm.25
d2= Ø mm.24
d3= Ø mm.31
d4= Ø mm.25
d5= Ø mm.15

L1= lunghezza mm. 7
L2= lunghezza mm.11,5
L3= lunghezza mm.25

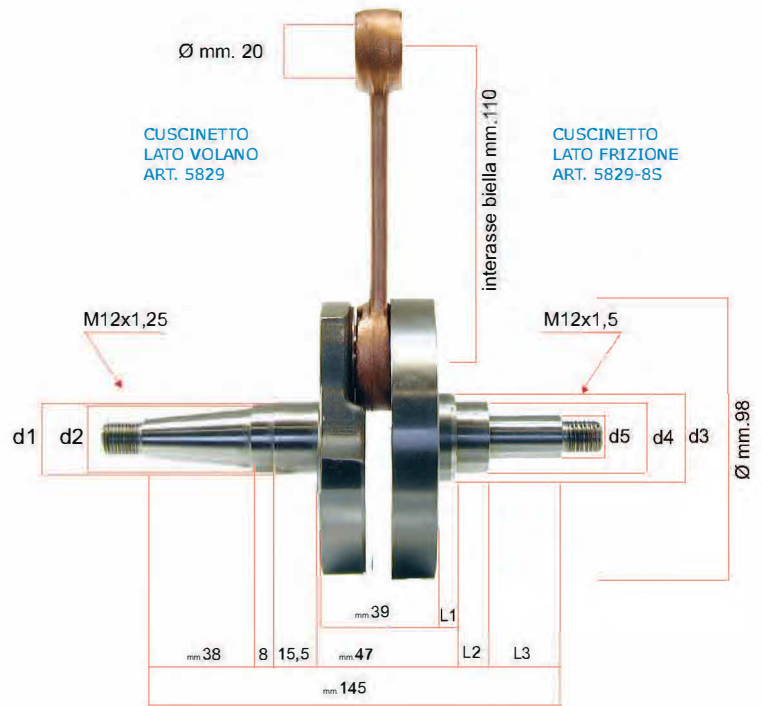

mazzucchelli

AMT 164

MODELLO ORIGINALE (CORSA mm.57)



ART. **5178**

MODELLO ORIGINALE
ORIGINAL MODEL

CORSA ORIGINALE mm. 57
ORIGINAL STROKE mm. 57

mazzucchelli

AMT 166

MODELLO ANTICIPATO (CORSA mm.57) **



ART. **5178-A**

MODELLO ANTICIPATO
BIELLA LUCIDA

ANTICIPATED MODEL
POLISHED CON-ROD

CORSA ORIGINALE mm. 57
ORIGINAL STROKE mm. 57



mazzucchelli

VESPA PE 200

**ALBERI MOTORE
CRANKSHAFTS**

"Racing"

CORSA LUNGA mm.60



mazzucchelli

AMT 166-M

MODELLO ANTICIPATO (CORSA mm.60) **

sviluppo valvola mm.200



ART. **5178-CLA**

MODELLO ANTICIPATO
BIELLA LUCIDA

ANTICIPATED MODEL
POLISHED CON-ROD

**CORSA LUNGA mm.60
LONG STROKE mm.60**

mazzucchelli

AMT 168/60

MODELLO ANTICIPATO (CORSA mm.60) MATERIALE K2D **



ART. **5178-CLKP**

MODELLO ANTICIPATO
BIELLA LUCIDA

ANTICIPATED MODEL
POLISHED CON-ROD

**CORSA LUNGA mm.60
LONG STROKE mm.60**

**REALIZZATO IN MATERIALE K2D
PER SOLLECITAZIONI AGONISTICHE**

mazzucchelli

AMT 166-MVT

MOD. COMPETIZIONE VOLANI TONDI (CORSA mm.60) **



ART. **5178-CLVT**

MODELLO ANTICIPATO
BIELLA LUCIDA

RACING MODEL WITH
ROUND FLYWHEELS
POLISHED CON-ROD

**CORSA LUNGA mm.60
LONG STROKE mm.60**

Per l'applicazione necessita collettore lamellare con modifica carter sull'aspirazione o aspirazione sul cilindro con conseguente chiusura del foro aspirazione sul carter.
The application needs lamellar manifold with modified crankcase on the intake or intake on cylinder with resulting the closure of the hole intake on the crankcase.

**ARTICOLO DESTINATO ALL'USO SU PISTA / ITEMS FOR USE ON TRACK

mazzucchelli



VESPA SUPER - SPRINT

adattabile / suitable:

VESPA 150 2% (1959)

125 (VNB1 ->6T) - GT - GTR 125

TS 125/150 (VBA-VBB) - GL 150

ALBERI MOTORE
CRANKSHAFTS



d1= Ø mm.25
d2= Ø mm.20
d3= Ø mm.25
d4= Ø mm.20
d5= Ø mm.15

L1= lunghezza mm.11,5
L2= lunghezza mm.8
L3= lunghezza mm.22,5

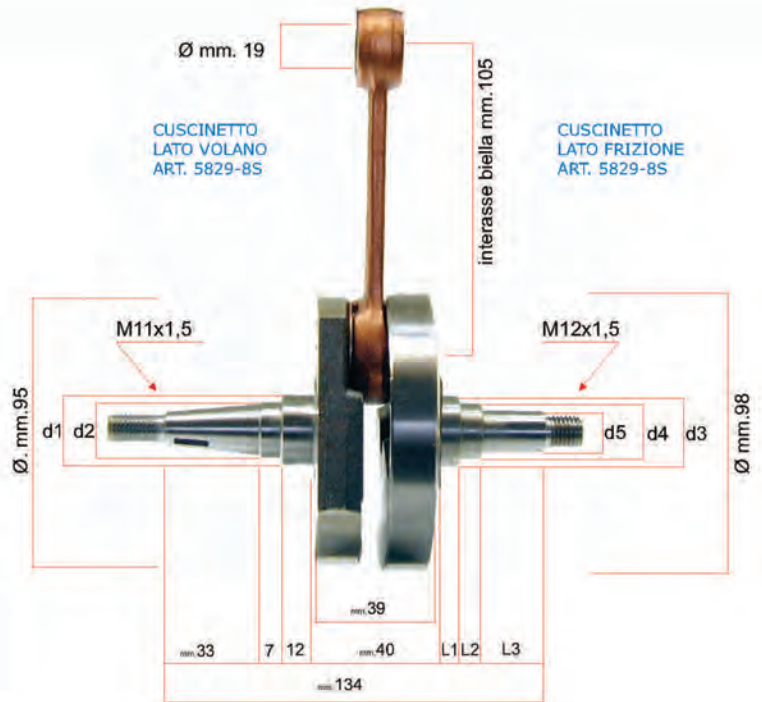

mazzucchelli

AMT 132

MODELLO ORIGINALE (CORSA mm.57)

sviluppo valvola mm.215



ART. **5176**

MODELLO ORIGINALE
ORIGINAL MODEL

CORSA ORIGINALE mm. 57
ORIGINAL STROKE mm. 57

RICAMBI PER LA REVISIONE
REVISION SPARE PARTS

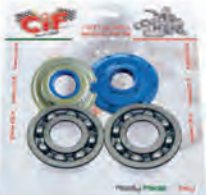

ART. **5166-KTC**



KIT REVISIONE ALBERO MOTORE
CON **PARAOLI CORTECO**
CRANKSHAFT REVISION KIT
WITH **CORTECO OIL SEALS**



ART. **5166-KTR**



KIT REVISIONE ALBERO MOTORE
CON **PARAOLI ROLF**
CRANKSHAFT REVISION KIT
WITH **ROLF OIL SEALS**



ART. **6646**



SERIE PARAOLI COMPLETA CON PARAOLI **ROLF**
COMPLETE SET OIL SEALS WITH **ROLF OIL SEALS**
VESPA SPRINT 150 (VLB1T) - SPRINT VELOCE
VESPA GT 125 (VNL2T) - GTR 125 (VNL2T)
VESPA VNA-VNB-VBA-VBB - SUPER - GL 150 (VLA1T)



ART. **6648-C**



SR.PARAOLI COMPLETA CON PARAOLI **CORTECO**
COMPLETE SET WITH **CORTECO OIL SEALS**
VESPA GL 150 (VLA1T '63-'64)-SPRINT 150 (VLB1T '65-'74)



ART. **6648-R**



SR.PARAOLI COMPLETA CON PARAOLI **ROLF**
COMPLETE SET WITH **ROLF OIL SEALS**
VESPA GL 150 (VLA1T '63-'64)-SPRINT 150 (VLB1T '65-'74)



mazzucchelli

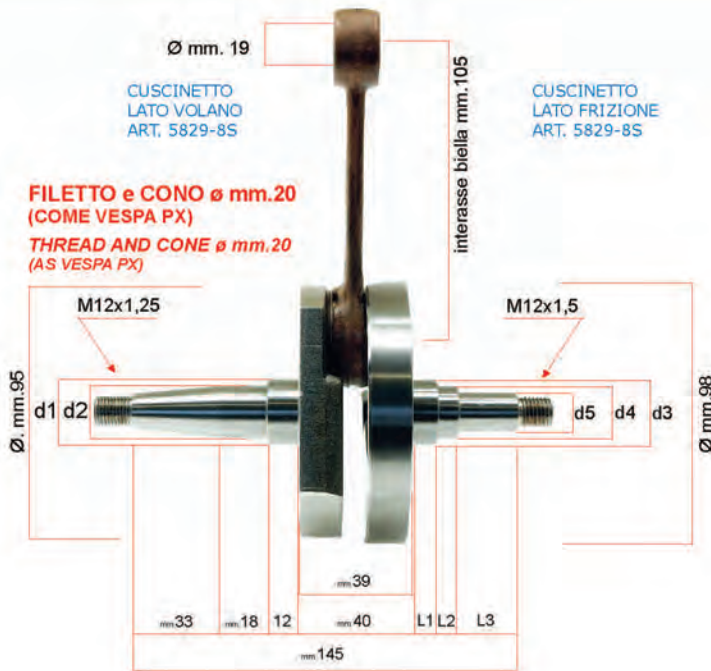

VESPA SUPER - SPRINT

adattabile / suitable:

VESPA 150 2% (1959)

125 (VNB1 ->6T) - GT - GTR 125

TS 125/150 (VBA-VBB) - GL 150

MODIFICA X INSTALLAZIONE ACCENSIONE ELETTRONICA TIPO VESPA PX con CONO Ø mm.20

MODIFICATION FOR INSTALLATION ELECTRONIC IGNITION

VESPA PX TYPE with CONE Ø mm.20

- d1= Ø mm.25
- d2= Ø mm.20
- d3= Ø mm.25
- d4= Ø mm.20
- d5= Ø mm.15
- L1= lunghezza mm.11,5
- L2= lunghezza mm.8
- L3= lunghezza mm.22,5

ALBERI MOTORE
CRANKSHAFTS

"Racing"



mazzucchelli

AMT 133

MODELLO VERSIONE NORMALE (CORSA mm.57) **

SI MONTA CON ACCENSIONE TIPO VESPA PX CON CONO LATO VOLANO RINFORZATO Ø mm.20
IT CAN BE MOUNTED WITH IGNITION VESPA PX TYPE WITH FLYWHEEL SIDE REINFORCED CONE Ø mm.20



ART. **5176-AE**

MODELLO NORMALE

NORMAL MODEL

CORSA / STROKE mm. 57

mazzucchelli

AMT 135

MODELLO VERSIONE RACE (CORSA mm.57) **

SI MONTA CON ACCENSIONE TIPO VESPA PX CON CONO LATO VOLANO RINFORZATO Ø mm.20
IT CAN BE MOUNTED WITH IGNITION VESPA PX TYPE WITH FLYWHEEL SIDE REINFORCED CONE Ø mm.20

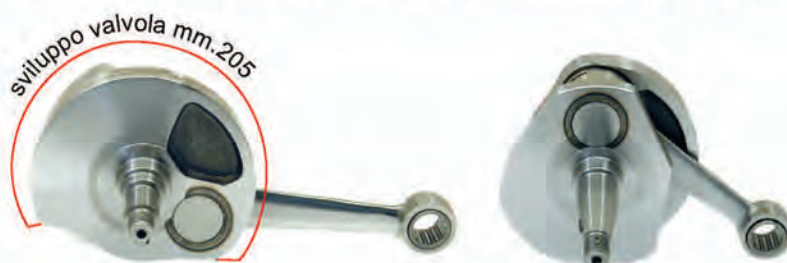

ART. **5176-AER**

MODELLO RACING
BIELLA LUCIDA

RACE MODEL
POLISHED CON-ROD

CORSA / STROKE mm. 57

**ARTICOLO DESTINATO ALL'USO SU PISTA / ITEMS FOR USE ON TRACK

VESPA RALLY 200



- d1= Ø mm.25
- d2= Ø mm.24
- d3= Ø mm.21
- d4= Ø mm.31
- d5= Ø mm.25
- d6= Ø mm.15

- L1= lunghezza mm. 11
- L2= lunghezza mm.25

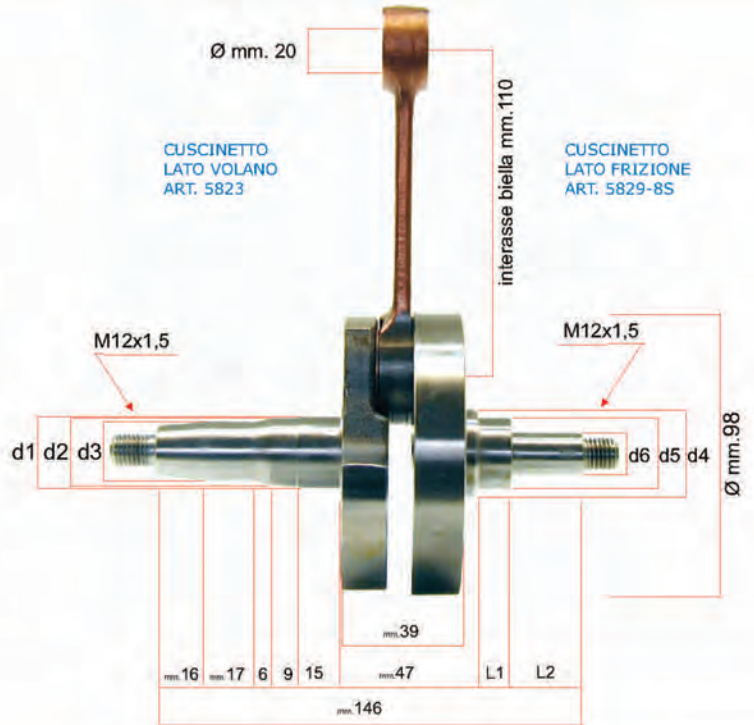

MODELLO ORIGINALE

sviluppo valvola mm.215



ART. **5171**

MODELLO ORIGINALE

ORIGINAL MODEL

RICAMBI PER LA REVISIONE
REVISION SPARE PARTS



ART. **5210-KT** **ROLF**
KIT REVISIONE ALBERO MOTORE
CON **PARAOLI ROLF**
CRANKSHAFT REVISION KIT
WITH **ROLF OIL SEALS**



ART. **6645** **ROLF**
SERIE PARAOLI COMPLETA
CON **PARAOLI ROLF**
COMPLETE SET OIL SEALS
WITH **ROLF OIL SEALS**



ALBERI MOTORE
CRANKSHAFTS

MADE in ITALY

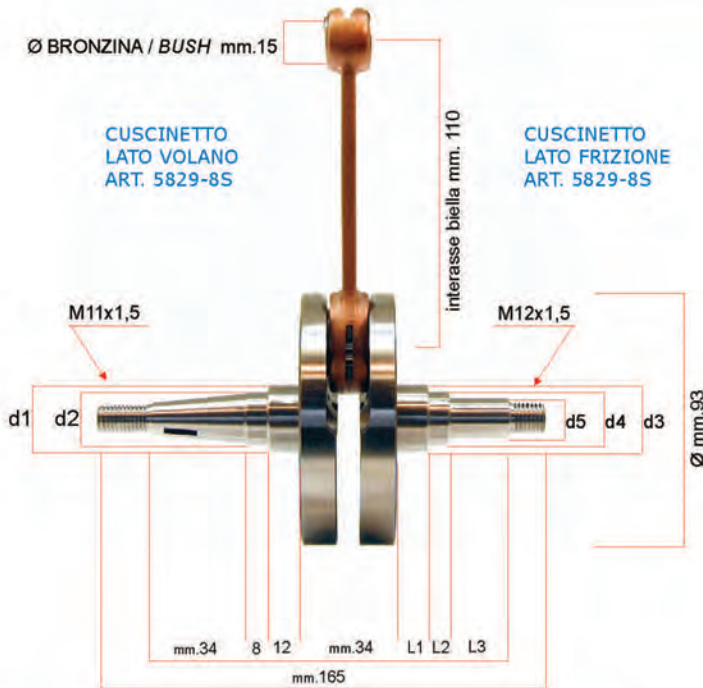

- d1= Ø mm.25
- d2= Ø mm.20
- d3= Ø mm.25
- d4= Ø mm.20
- d5= Ø mm.15
- L1= lunghezza mm.12
- L2= lunghezza mm.8
- L3= lunghezza mm.22

VESPA 125 VN1/VN2 - VM1/VM2 adattabile/suitable: ACMA PARIS 125 (1951-1955)



ART. **5194-110**

MODELLO ORIGINALE
ORIGINAL MODEL

BIELLA / CON-ROD mm. 110

CORSA / STROKE mm. 54

MODELLO ORIGINALE (CORSA mm.54)

VESPA 150 VL1/2/3T - VESPA 150 VB1T (1957-1958)



ART. **5195-110**

MODELLO ORIGINALE
ORIGINAL MODEL

BIELLA / CON-ROD mm. 110

CORSA / STROKE mm. 57

MODELLO ORIGINALE (CORSA mm.57)

MADE in ITALY

ALBERI MOTORE
CRANKSHAFTS

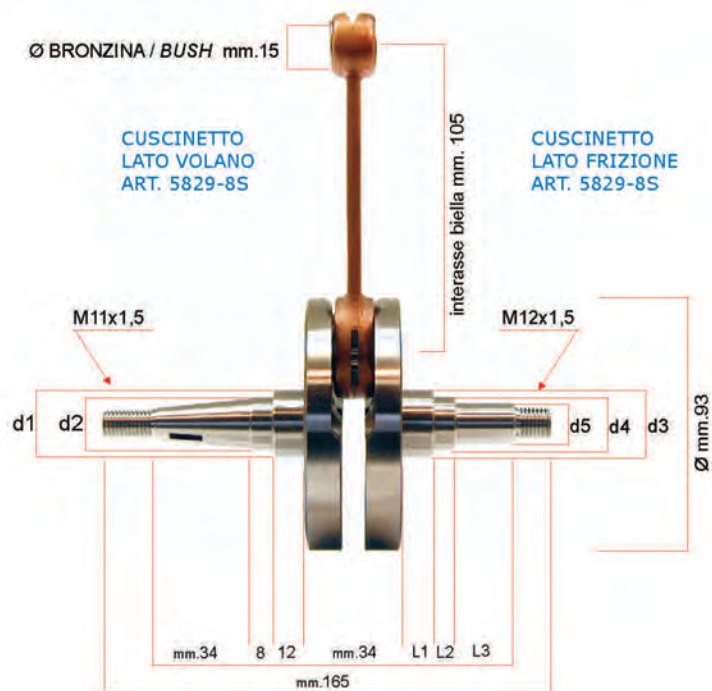

d1= Ø mm.25
d2= Ø mm.20
d3= Ø mm.25
d4= Ø mm.20
d5= Ø mm.15
L1= lunghezza mm.12
L2= lunghezza mm.8
L3= lunghezza mm.22

VESPA 125 VNA1T-VNA2T (1957-1958)



ART. **5194-105**

MODELLO ORIGINALE
ORIGINAL MODEL

BIELLA / CON-ROD **mm. 105**

CORSA / STROKE **mm. 54**

MODELLO ORIGINALE (CORSA mm.54)



ART. **5195-105**

MODELLO ORIGINALE
ORIGINAL MODEL

BIELLA / CON-ROD **mm. 105**

CORSA / STROKE **mm. 57**

MODELLO ORIGINALE (CORSA mm.57)



ALBERI MOTORE

CRANKSHAFTS

MADE in ITALY

VESPA 125 dal V30 al V33 (1951-1952)

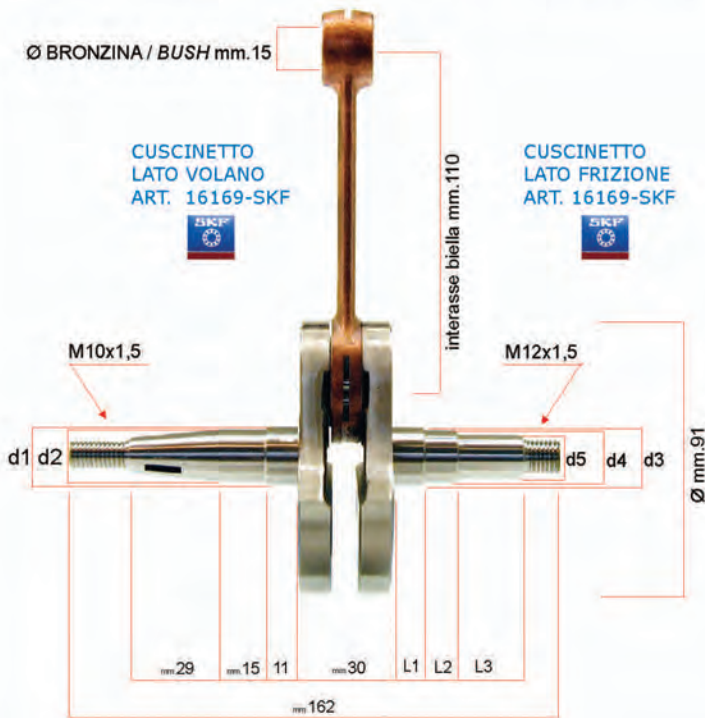

MODELLO ORIGINALE



ART. 5196
MODELLO ORIGINALE
ORIGINAL MODEL

d1= Ø mm.20	L1= lunghezza mm.11
d2= Ø mm.18	L2= lunghezza mm.11
d3= Ø mm.20	L3= lunghezza mm.22
d4= Ø mm.18	
d5= Ø mm.15	

VESPA 180 SS

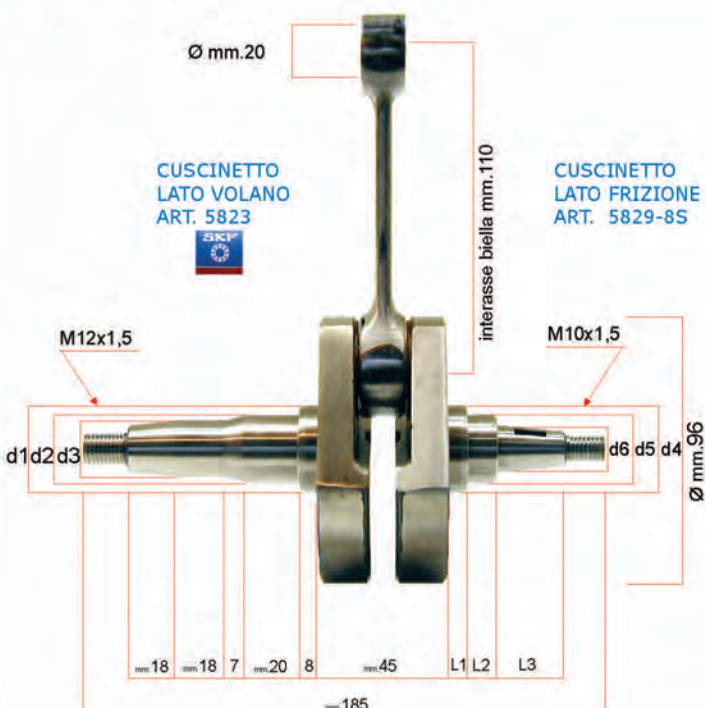

MODELLO ORIGINALE



ART. 5197
MODELLO ORIGINALE
ORIGINAL MODEL

d1= Ø mm.32	L1= lunghezza mm.8
d2= Ø mm.25	L2= lunghezza mm.11
d3= Ø mm.21	L3= lunghezza mm.25
d4= Ø mm.32	
d5= Ø mm.25	
d6= Ø mm.17	

MADE in ITALY

ALBERI MOTORE
CRANKSHAFTS

VESPA GS 150 VS1/2/3/4/5 (1955-1961)

MODELLO ORIGINALE

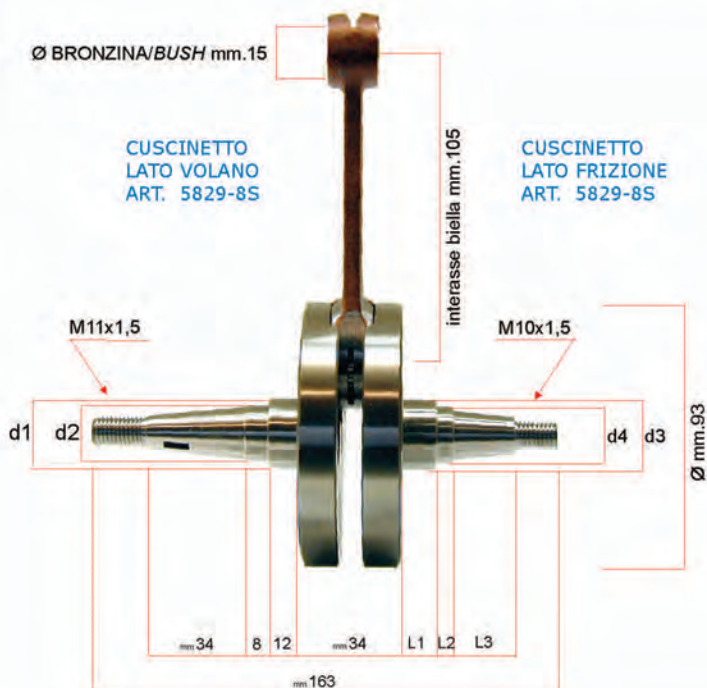

MADE in ITALY

ART. 5198
MODELLO ORIGINALE
ORIGINAL MODEL

d1= Ø mm.25	L1= lunghezza mm.12
d2= Ø mm.20	L2= lunghezza mm.6
d3= Ø mm.25	L3= lunghezza mm.22
d4= Ø mm.20	

VESPA GS 160 VSB1T (1962-1965)

MODELLO ORIGINALE

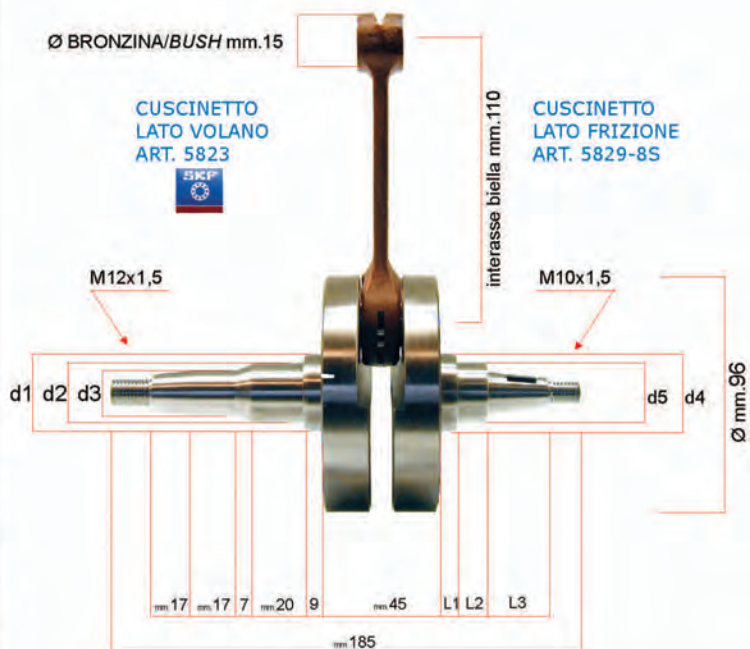

MADE in ITALY

ART. 5199
MODELLO ORIGINALE
ORIGINAL MODEL

d1= Ø mm.32	L1= lunghezza mm.8
d2= Ø mm.25	L2= lunghezza mm.12
d3= Ø mm.19	L3= lunghezza mm.24
d4= Ø mm.32	
d5= Ø mm.25	



BIELLE COMPLETE CON-RODS



mazzucchelli

mazzucchelli

BCO 0482



ART. **7150**

BIELLA COMPLETA

(Sim. 150366)

VESPA 50 - PK 50 - PK 50 XL - APE 50

INTERASSE BIELLA mm.87
ASSE ACCOPPIAMENTO Ø 20
GABBIA SPINOTTO 12 x 17 x 13
GABBIA ASSE ACCOPPIAMENTO ARGENTATA

mazzucchelli

BCO 0488



ART. **7151**

BIELLA COMPLETA

(Sim. 91329)

VESPA 90 - 125 PRIMAVERA - ET3
VESPA PK 125 - PK 125 XL - APE 250

INTERASSE BIELLA mm.97
ASSE ACCOPPIAMENTO Ø 20
GABBIA SPINOTTO 15 x 19 x 20
GABBIA ASSE ACCOPPIAMENTO ARGENTATA

mazzucchelli

BCO 0503



ART. **7152**

BIELLA COMPLETA

(S.137769-241205)

VESPA PX 125-150-200 ('98-'01)
VESPA PXE ARCOBALENO 125-150-200 ('81-'97)
VESPA PX EU2 125 ('01-'06)

INTERASSE BIELLA mm.105
ASSE ACCOPPIAMENTO Ø 22
GABBIA SPINOTTO 15 x 19 x 20
GABBIA ASSE ACCOPPIAMENTO ARGENTATA

mazzucchelli

BCO 0502



ART. **7153**

BIELLA COMPLETA

(Sim. 132053)

VESPA PE 200 - PE 200 ARCOBALENO
VESPA RALLY 200

INTERASSE BIELLA mm.110
ASSE ACCOPPIAMENTO Ø 22
GABBIA SPINOTTO 16 x 20 x 20
GABBIA ASSE ACCOPPIAMENTO ARGENTATA

GABBIE SPINOTTO BIELLA ROLLER CAGES



CIF ART.	DIMENSIONI / SIZE	APPLICAZIONI / APPLICATIONS
5623	12 - 17 - 13	VESPA 50 - PK 50 - PK 50 XL - PIAGGIO SFERA - QUARTZ - ZIP - APE 50 (Sim.112145)
5623-15	12 - 17 - 15	VESPA 50 - PK 50 - PK 50 XL - SCOOTER MOTORI PIAGGIO - APE 50
5624	15 - 19 - 20	VESPA 125 PRIMAVERA - ET3 - PK 125 - PK 125 XL - PX 125 (Sim.500541)
5625	16 - 20 - 20	VESPA PE 200 - RALLY - APE MP - APE 175 - MOTORI FBM (Sim.151805)

CUSCINETTI DI BANCO

CRANKSHAFT BEARINGS



ART. **5829-8S** CUSCINETTO DI BANCO A **8 SFERE 25 - 62 - 12** (Sim. 97804)
(NA) TIPO ORIG.
BANCO LATO FRIZIONE E VOLANO / *CLUTCH AND FLYWHEEL SIDE*:
VESPA 125 E 150 SPRINT - SUPER - GS 160 - SS 180 - RALLY 180-200
BANCO SOLO LATO FRIZIONE / *ONLY FOR CLUTCH SIDE*:
VESPA PX 125 - 150 - 200 ARCOBALENO



ART. **5829** CUSCINETTO A RULLI **25 - 38 - 15** (Sim.133068)
(NA) TIPO ORIG.
BANCO LATO VOLANO / *FLYWHEEL SIDE*
VESPA PX 125 - 150 - 200 - PK 125



ART. **5823** CUSCINETTO A RULLI **25 - 52 - 15** (SKF NU 205 EPC-C3) (Sim.235724)
LATO VOLANO / *FLYWHEEL SIDE*
VESPA RALLY 180-200 - GS 160 - SS180
VESPA PX 125 T5 ('85-'89)



ART. **6204-NU** CUSCINETTO A RULLI **20 - 47 - 14** (SKF NU 6204 ECP) (Sim.71605)
LATO VOLANO / *FLYWHEEL SIDE*
SPECIFICO PER / *SPECIFIED FOR*:
VESPA ET3 DAL 1980



ART. **6204-NUE** CUSCINETTO A RULLI **20 - 47 - 14** (NRB NU 6204 ECP) (Sim.71605)
LATO VOLANO / *FLYWHEEL SIDE*
SPECIFICO PER / *SPECIFIED FOR*:
VESPA ET3 DAL 1980



ART. **16204-C4** CUSCINETTO **20 - 47 - 14** (SKF 6204-C4) (Sim.71605)
GABBIA IN FERRO / *STEEL CAGE*
TOLLERANZA **C4**
BANCO LATO VOLANO / *FLYWHEEL SIDE*



ART. **16167-C4** CUSCINETTO **20 - 47 - 14** (SKF 6204-C4-TN9C4) (Sim.71605)
GABBIA IN POLIAMMIDE / *POLYAMIDE CAGE*
TOLLERANZA **C4**
BANCO LATO VOLANO / *FLYWHEEL SIDE*



ART. **16204-NBB** CUSCINETTO **20 - 47 - 14** (6204-NBB)
GABBIA IN FERRO / *STEEL CAGE*
TOLLERANZA **C3**
BANCO LATO VOLANO / *FLYWHEEL SIDE*



ART. **16303-C3** CUSCINETTO **17 - 47 - 14** (SKF 6303-C3) (Sim.71605)
BANCO LATO FRIZIONE / *CLUTCH SIDE*





SERIE PARAOLI MOTORE

OIL SEALS SET

CON PARAOLI / WITH OIL SEALS



TABELLA RIEPILOGATIVA

SERIE PARAOLI MOTORE

OIL SEALS SET LIST



CIF ART.	APPLICAZIONI / APPLICATIONS	
5696	VESPA 50-90-125 PRIMAVERA - ET3 - PK 50	
5696-V	VESPA 50-90-125 PRIMAVERA - ET3 - PK 50	Viton Oil seals
5699-C	VESPA PX 125 - 150 - PX ARCOBALENO	
5699-CV	VESPA PX 125 - 150 - PX ARCOBALENO	Viton Oil seals
6643	VESPA GS 160 - VESPA 180 SS	
6645	VESPA RALLY 180 - 200	
6646	VESPA SPRINT 150 (VLB1T) - SPRINT VELOCE - GT 125 (VNL2T) GTR 125 (VNL2T) - VNA-VNB-VBA-VBB - SUPER - GL 150 (VLA1T)	
6647-C	VESPA 125 (VM1/2T '53-'54) - 125 (VN1/2 '54-'57) - (VNA 1/2T '58-'59) VESPA 150 (VL1/2/3T '55-'56)-(VB1T '57-'58) - GS 150 (VS1/2/3/4/5 '55-'61)	CORTECO
6647-R	VESPA 125 (VM1/2T '53-'54) - 125 (VN1/2 '54-'57) - (VNA 1/2T '58-'59) VESPA 150 (VL1/2/3T '55-'56)-(VB1T '57-'58) - GS 150 (VS1/2/3/4/5 '55-'61)	lato volano/frizione flywheel/clutch side ROLF
6648-C	VESPA 150 (VLA1T '63-'64) - SPRINT 150 (VLB1T '65-'74)	CORTECO
6648-R	VESPA 150 (VLA1T '63-'64) - SPRINT 150 (VLB1T '65-'74)	lato volano/frizione flywheel/clutch side ROLF
6649	VESPA PX 200 ARCOBALENO	
6649-V	VESPA PX 200 ARCOBALENO	Viton Oil seals
6651	VESPA PK 125 - PK 125 XL	
6652	VESPA 125 T5	
6652-V	VESPA 125 T5	Viton Oil seals
6653	VESPA PK 50 XL - FL	
6653-V	VESPA PK 50 XL - FL	Viton Oil seals

TABELLA IN ORDINE CRESCENTE IN BASE AL Ø INTERNO / LIST IN ORDER OF INTERNAL Ø

DIMENSIONI Ø			Rif.Orig.	CIF ART.	Applicazioni	
int.	est.	h				
10	18	4	152351	5932	per coperchio frizione / for clutch cover : VESPA 50/125 FL-50 HP APE MP 501-P601-220 (1978-1976) per girante pompa acqua / for h20 pump rotor Scooter motori MINARELLI-YAMAHA 50 cc.	CORTECO 
17	40	7	008722	5946	ruota anteriore / front wheel VESPA 50 - 90 (1ª SERIE) VESPA RALLY - GT - SPRINT VESPA TS - SUPER	CORTECO 
18	35	8 NBR		5961	lato frizione-lato volano / clutch-flywheel side VESPA 98 ('46-'47) VESPA 125 ('48-'52) FARO BASSO	ROLF 
19	32	7	430390 155579	5904	lato volano / flywheel side VESPA 50 - 90 - PRIMAVERA - Et3 VESPA PK 50 APE 50	CORTECO 
19	32	7 Vm		5904-V	VITON MARRONE / BROWN VITON lato volano / flywheel side VESPA 50 - 90 - PRIMAVERA - ET3 VESPA PK 50 APE 50	CORTECO  
20	32	7 RP	289306 17016	5965-C	CON LABBRO PARAPOLVERE lato volano / flywheel side VESPA PK 50 XL - PK FL APE 50 FL2	CORTECO 
20	32	7 FPM RPVm	430392	5965-V	VITON MARRONE / BROWN VITON CON LABBRO PARAPOLVERE lato volano / flywheel side VESPA PK 50 XL - PK F12 APE 50 FL2	CORTECO  
20	35	7 NBR		5962-C	PER CARTER MODIFICATO QUATTRINI lato frizione / clutch side VESPA 50 - 90 - 125 PRIMAVERA - ET3 VESPA PK 50 - PK 50 XL	CORTECO 



ANELLI DI TENUTA VESPA

VESPA OIL SEALS



TABELLA IN ORDINE CRESCENTE IN BASE AL Ø INTERNO / LIST IN ORDER OF INTERNAL Ø

DIMENSIONI Ø int. est. h	Rif.Orig.	CIF ART.	Applicazioni	
20 40 6 FG	025180	5947	FLANGIATO TACCA TONDA / TICK ROUND lato volano / flywheel side VESPA SPRINT - SPRINT VELOCE VESPA GT - GTR - VESPA SUPER VESPA GL 150 - GS 150 (VS1-2-3-4-5T)	ROLF 
20 40 6 FG	084644	5947-AC	FLANGIATO TACCA QUADRA/TICK SQUARE lato volano / flywheel side: VESPA SPRINT - SUPER - GTR - TS GL 150 lato frizione-volano / clutch and flywheel side : VESPA 125/150 - GS 150	CORTECO 
20 40 6 FG	084644	5947-AR	FLANGIATO TACCA QUADRA/TICK SQUARE lato volano / flywheel side: VESPA SPRINT - SUPER - GTR - TS GL 150 lato frizione-volano / clutch and flywheel side : VESPA 125/150 - GS 150	ROLF 
20 62 6,5	49290	5949-C	lato frizione / clutch side VESPA SPRINT 150 - SPRINT VELOCE VESPA GT - GTR - SUPER VESPA GL 150 - 125 TS VESPA 125/150	CORTECO 
20 62 6,5	49290	5949-R	lato frizione / clutch side VESPA SPRINT 150 - SPRINT VELOCE VESPA GT - GTR - SUPER VESPA GL 150 - 125 TS VESPA 125/150	ROLF 
22,7 47 7	289305 8731	5906	lato frizione / clutch side VESPA 50 - 90 - PRIMAVERA - ET3 VESPA PK 50/125 - PK 50/125 XL VESPA FL APE 50	CORTECO 
22,7 47 7 Vm	430391	5906-V	VITON MARRONE / BROWN VITON lato frizione / clutch side VESPA 50 - 90 - PRIMAVERA - ET3 VESPA PK 50/125 - PK 50/125 XL - FL APE 50	CORTECO 
24 32 7 NRB		5899-C	LAMIERA ESTERNA lato volano / flywheel side x modifica: si utilizza per installare albero motore PK 125 c/cono grosso SU : VESPA 50 - 90 - PRIMAVERA - ET3 VESPA PK 50 - PK 50 XL	CORTECO 

TABELLA IN ORDINE CRESCENTE IN BASE AL Ø INTERNO / LIST IN ORDER OF INTERNAL Ø

DIMENSIONI Ø int. est. h	Rif.Orig.	CIF ART.	Applicazioni	
24 35 6	431121 158962	5907	lato volano / flywheel side VESPA PX 125 /150 VESPA PX 125/150/200 ARCOBALENO VESPA 125 T5 - PK 125 - PK 125 XL	ROLF 
24 35 6 R	431121 158962	5907-C	lato volano / flywheel side VESPA PX 125 /150 VESPA PX 125/150/200 ARCOBALENO VESPA 125 T5 - PK 125 - PK 125 XL	CORTECO 
24 40 7	008708	5943	ruota anteriore / front wheel VESPA 50 - 90 - 125 PRIMAVERA - Et3	CORTECO 
24,9 45 5,5/6,5		5958	lato volano esterno / flywheel external side VESPA GS 160 - 180 SS	PHLE 
25 40 7	128217	5909	ruota anteriore / front wheel VESPA 50 - 90 - 125 - PRIMAVERA - ET3 VESPA PK 50 carter differenziale / differential housing APE 50 FI2	CORTECO 
27 37 7	46699	5910	ruota posteriore / rear wheel VESPA 50 - 90 - 125 - PRIMAVERA - ET3 VESPA PK 50/125 - PK 50/125 XL - FL	CORTECO 
27 37 7	46699	5910-R	ORIGINALE DI 1ª EQUIPAGGIAMENTO ruota posteriore / rear wheel VESPA 50 - 90 - 125 - PRIMAVERA - ET3 VESPA PK 50/125 - PK 50/125 XL - FL	ROLF 
27 42 10	118058	5957	ruota posteriore / rear wheel VESPA 125/150 - GS 150 - 125 T5 VESPA COSA APE 50 - TM 50 - P50	CORTECO 
27 47 6	130536	5911	ruota posteriore / rear wheel VESPA PX 125-150 - PX ARCOBALENO RALLY 200- SPRINT - SPRINT VELOCE VESPA GT - GTR - SUPER GL 150	ROLF 
27 47 6	130536	5911-C	ruota posteriore / rear wheel VESPA PX 125-150 - PX ARCOBALENO RALLY 200- SPRINT - SPRINT VELOCE GT - GTR - SUPER GL 150	CORTECO 



ANELLI DI TENUTA VESPA

VESPA OIL SEALS



TABELLA IN ORDINE CRESCENTE IN BASE AL Ø INTERNO / LIST IN ORDER OF INTERNAL Ø

DIMENSIONI Ø int. est. h	Rif.Orig.	CIF ART.	Applicazioni	
30 40 7		5953	asse ruota posteriore / rear wheel axle VESPA GS 160	CORTECO 
30 47 6	478498 8714	5950	asse ruota posteriore / rear wheel axle VESPA PE 200 ARCOBALENO SCOOTER PIAGGIO - GILERA	CORTECO 
31 62,5 6	131102	5912	TUTTO GOMMA / ALL RUBBER lato frizione / clutch side VESPA PX PE 125-150-200 VESPA PX PE ARCOBALENO 125-150-200 VESPA 125 T5 - RALLY 180-200	ROLF 
31 62 5,8/4,3	131102	5912-C	lato frizione / clutch side VESPA PX PE 125-150-200 VESPA PX PE ARCOBALENO 125-150-200 VESPA 125 T5 - RALLY 180-200	CORTECO 
31 62,1 5,8/4,3	242549	5912-L	lamiera esterna / sheet metal external lato frizione / clutch side VESPA PX PE 125-150-200 VESPA PX PE ARCOBALENO 125-150-200 VESPA 125 T5 - RALLY 180-200	CORTECO 
31 62,1 5,8/4,3 Vm	242550	5912-LV	(lamiera esterna / sheet metal external) interno / internal VITON MARRONE / BROWN lato frizione / clutch side VESPA PX PE 125-150-200 VESPA PX PE ARCOBALENO 125-150-200 VESPA 125 T5 - RALLY 180-200	CORTECO 
32 52 5	77976	5913	lato volano interno / flywheel internal VESPA GS 160 - 180 SS APE MP P501-P601 - APE 500 - APE 600	CORTECO 
32 57/61 6 NBR-SEZ.SC5		5959	lato frizione / clutch side VESPA GS 160 - 180 SS	PHLE 

ANELLI OR

O-RINGS



ART. 7010-KT

KIT ANELLINI OR
PER SERIE PARAOLI MOTORE

RINGS SET FOR ENGINE OIL SEALS

VESPA 50-90-125 PRIMAVERA-ET3
VESPA PK 50/125 - PK 50/125 XL - FL



ART. 7011-KT

KIT ANELLINI OR
PER SERIE PARAOLI MOTORE

RINGS SET FOR ENGINE OIL SEALS

VESPA PX 125/150/200 - PX 125/150/200 ARCOBALENO
VESPA 125 T5 VESPA GS 160 - VESPA 180 SS
VESPA RALLY 180/200 - VESPA 150 (VLA1T '63-'64)
SPRINT 150 (VLB1T '65-'74)

ART. 7000

ANELLINO **OR 210** (15.88x2,62)

PER SETTORE MESSA IN MOTO
VESPA 50-90-125 PRIMAVERA-ET3-PK-PX

(Sim. 006721)



ART. 7003

ANELLINO **OR 080** (8.73x1.78)

PER LEVA COMANDO FRIZIONE
VESPA PX PE

(Sim. 006708)



ART. 7001

ANELLINO **OR 060** (6.75x1.78)

PER FORCELLA CAMBIO
VESPA 50 - 90 - 125 PRIMAVERA - Et3

(Sim. 006706)



ART. 7008

ANELLINO **OR 140** (11.11x1.78)

PER CEPPI FRENI RUOTA POSTERIORE
VESPA PX-GL 150 - SPRINT 150 - RALLY

(Sim. 006714)



ART. 7002

ANELLINO **OR 160**

PER LEVA FENO
VESPA 50-90-125 PRIMAVERA - Et3

(Sim. 006716)



ART. 7016

ANELLO **OR 362** (28.24x2.6)

PARAPOLVERE PER PERNO FORCELLA
VESPA 50 - 90 - 125 PRIMAVERA ET3 - PK 50

(Sim. 93188- 14013)



ART. 7018

ANELLO 120x2,15
PER COPERCHIO FRIZIONE

VESPA PX 125-150 - 200 - PX ARCOBALENO
VESPA GL 150 - SPRINT 150 - RALLY 180 - 200

(Sim. 017781)



KIT REVISIONE ALBERI MOTORE

CRANKSHAFTS REVISION KIT

CON PARAOLI / WITH OIL SEALS



TABELLA RIEPILOGATIVA

KIT REVISIONE ALBERO MOTORE

CRANKSHAFTS REVISION KIT LIST



CIF ART.	APPLICAZIONI / APPLICATIONS	
5166-KTC	VESPA SPRINT - SUPER - GTR - TS	
5166-KTR	VESPA SPRINT - SUPER - GTR - TS	
5169-KT	VESPA 50 - 90 - 125 PRIMAVERA - ET3 - PK -PK XL - FL	
5169-KTV	VESPA 50 - 90 - 125 PRIMAVERA - ET3 - PK -PK XL - FL	Viton Oil seals
5170-KT	VERSIONE/VERSION "ECO-PLUS" SPECIFICO PER / SPECIFIC FOR : VESPA 125 PRIMAVERA ET3	
5170-KVE	VERSIONE/VERSION "ECO-VITON PLUS" SPECIFICO PER / SPECIFIC FOR : VESPA 125 PRIMAVERA ET3	Viton Oil seals
5170-KTV	VERSIONE/VERSION "TOP PREMIUM" SPECIFICO PER / SPECIFIC FOR : VESPA 125 PRIMAVERA ET3	Viton Oil seals
5171-KT	VESPA 98 (1946-1947) VESPA 125 (1948-1952) FARO BASSO	
5177-KTV	VESPA 125 T5	Viton Oil seals
5180-KT	VESPA PX PE 125-150-200 - PX PE ARCOBALENO	
5180-KTV	VESPA PX PE 125-150-200 - PX PE ARCOBALENO	Viton Oil seals
5210-KT	VESPA RALLY 180 - 200	
5212-KT	VESPA GS 150 (VS 1-2-3-4-5T)	
5214-KT	VESPA GS 160 - VESPA 180 SS	

CON PARAOLI



KIT REVISIONE ALBERO MOTORE

CRANKSHAFT REVISION KIT

VESPA 50-90-125 PRIMAVERA ET3 - PK - PK XL - FL

ART. **5169-KT**

KIT REVISIONE ALBERO MOTORE

CON **PARAOLI BLU** 

CRANKSHAFT REVISION KIT

WITH **BLUE**  OIL SEALS



KIT Composto da / Kit composed of:

CIF ART.	Pz/Pcs	Descrizione / Description
5906	1	paraolio lato frizione / oil seal, clutch side
5965	1	paraolio lato volano / oil seal, flywheel side (x VESPA PK XL-FL)
5904	1	paraolio lato volano / oil seal, flywheel side (x VESPA 50-90-PRIM.)
16204-C4	1	cuscinetto (SKF6204-C4) lato volano / bearing, flywheel side
16303-C3	1	cuscinetto (SKF6303-C3) lato frizione / bearing, clutch side
7010-KT	1	Kit anelli OR / rings set

ART. **5169-KTV**

KIT REVISIONE ALBERO MOTORE



VERSIONE **CON PARAOLI**  **IN VITON**

CRANKSHAFT REVISION KIT

VERSION **WITH**  OIL SEALS **IN VITON**



KIT Composto da / Kit composed of:

CIF ART.	Pz/Pcs	Descrizione / Description
5906-V	1	paraolio lato frizione in Viton Marrone oil seal, clutch side, in Brown Viton 
5965-V	1	paraolio doppio labbro lato volano in Viton Marrone oil seal, flywheel side, double lip in Brown Viton (x VESPA PK XL-FL) 
5904-V	1	paraolio lato volano in Viton Marrone oil seal, flywheel side, in Brown Viton (x VESPA 50-90-PRIM.) 
16204-C4	1	cuscinetto (SKF6204-C4) lato volano / bearing, flywheel side
16303-C3	1	cuscinetto (SKF6303-C3) lato frizione / bearing, clutch side
7010-KT	1	Kit anelli OR / rings set

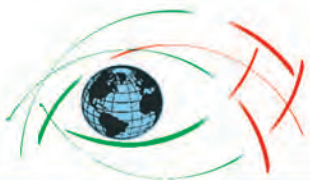

KIT REVISIONE ALBERO MOTORE

CRANKSHAFT REVISION KIT

CON PARAOLI **CORTECO**

SPECIFICO PER / SPECIFIC FOR: **VESPA PRIMAVERA ET3**

ART. 5170-KT

VERSIONE **ECO-PLUS**
CON CUSCINETTO A RULLI LATO VOLANO
PARAOLI CORTECO BLU

ECO-PLUS VERSION
WITH ROLLER BEARING FLYWHEEL SIDE
CORTECO BLUE OIL SEALS



KIT Composto da / Kit composed of:

CIF ART.	Pz/Pcs	Descrizione / Description
5906	1	paraolio lato frizione / oil seal clutch side
5904	1	paraolio lato volano / oil seal flywheel side
6204-NUE	1	cuscinetto (NU 6204-ECP) lato volano / bearing flywheel side
16303-C3	1	cuscinetto (SKF 6303-C3) lato frizione / bearing clutch side
7010-KT	1	Kit anelli OR / rings set

ART. 5170-KVE

VERSIONE **ECO-VITON PLUS**
CON CUSCINETTO A RULLI LATO VOLANO
PARAOLI CORTECO IN VITON (LATO FRIZIONE E VOLANO)

ECO-VITON PLUS VERSION
WITH ROLLER BEARING, FLYWHEEL SIDE
CORTECO VITON OIL SEALS, (CLUTCH AND FLYWHEEL SIDE)



Viton
Oil seals

KIT Composto da / Kit composed of:

CIF ART.	Pz/Pcs	Descrizione / Description
5906-V	1	par.lato frizione in Viton Marrone/ oil seal, clutch side
5904-V	1	par.lato volano in Viton Marrone / oil seal, flywheel side
6204-NUE	1	cuscinetto (NU 6204-ECP) lato volano/ bearing flywheel side
16303-C3	1	cuscinetto (SKF 6303-C3) lato frizione / bearing clutch side
7010-KT	1	Kit anelli OR / rings set

ART. 5170-KTV

VERSIONE **TOP PREMIUM**
CON CUSCINETTO A RULLI LATO VOLANO **SKF**
PARAOLI CORTECO IN VITON (LATO FRIZIONE E VOLANO)

TOP PREMIUM VERSION
WITH **SKF** ROLLER BEARING, FLYWHEEL SIDE
CORTECO VITON OIL SEALS, (CLUTCH AND FLYWHEEL SIDE)



Viton
Oil seals

KIT Composto da / Kit composed of:

CIF ART.	Pz/Pcs	Descrizione / Description
5906-V	1	par.lato frizione in Viton Marrone/ oil seal, clutch side
5904-V	1	par.lato volano in Viton Marrone / oil seal, flywheel side
6204-NU	1	cuscinetto (SKF NU 6204-ECP) lato volano / flywheel side
16303-C3	1	cuscinetto (SKF 6303-C3) lato frizione / bearing clutch side
7010-KT	1	Kit anelli OR / rings set

Vespa Parts

CON PARAOLI



SERIE PARAOLI MOTORE

ENGINE OIL SEALS

VESPA 50-90-125 PRIMAVERA ET3 - PK 50

ART. 5696
 SERIE PARAOLI COMPLETA
 COMPLETE SET OIL SEALS
 CON PARAOLI / WITH OIL SEALS

SERIE COMPOSTA DA / SET COMPOSED OF:

	ART. 5906	lato frizione / <i>clutch side</i> (22,7 x 47 x 7)	(Sim.289305)
	ART. 5904	lato volano / <i>flywheel side</i> (19 x 32 x 7)	(Sim.155579-430390)
	ART. 5910	ruota posteriore / <i>rear wheel</i> (27 x 37 x 7)	(Sim.046699)
	ART. 7000	OR 210	(Sim. 6721)
	ART. 7001	OR 060	(Sim. 6706)
	ART. 7002	OR 160	(Sim. 6716)
	ART. 7003	OR 080	(Sim. 6708)

ART. 5696-V
 SERIE PARAOLI COMPLETA
 VERSIONE CON PARAOLIO
 LATO FRIZIONE/VOLANO
 IN VITON
 COMPLETE SET OIL SEALS
 VERSION WITH VITON OIL SEAL
 CLUTCH/FLYWHEEL SIDE
 CON PARAOLI / WITH OIL SEALS

SERIE COMPOSTA DA / SET COMPOSED OF:

	ART. 5906-V	lato frizione / <i>clutch side</i> (22,7 x 47 x 7Vm) in Viton Marrone / <i>Brown Viton</i>	(Sim. 430391)
	ART. 5904-V	lato volano / <i>flywheel side</i> (19 x 32 x 7) in Viton Marrone / <i>Brown Viton</i>	(Sim.155579-430390)
	ART. 5910	ruota posteriore / <i>rear wheel</i> (27 x 37 x 7)	(Sim.046699)
	ART. 7000	OR 210	(Sim. 6721)
	ART. 7001	OR 060	(Sim. 6706)
	ART. 7002	OR 160	(Sim. 6716)
	ART. 7003	OR 080	(Sim. 6708)



SERIE PARAOLI MOTORE

ENGINE OIL SEALS

CON PARAOLI **CORTECO**

VESPA PK 50 XL - VESPA FL

ART. 6653
 SERIE PARAOLI COMPLETA
 COMPLETE SET OIL SEALS

CON PARAOLI / WITH OIL SEALS

CORTECO

(Sim. 154819)

SERIE COMPOSTA DA / SET COMPOSED OF:

	ART. 5906	lato frizione / clutch side (22,7 x 47 x 7)	(Sim. 289305)
	ART. 5965-C	lato volano / flywheel side (20 x 32 x 7)	(17016-289306)
	ART. 5910	ruota posteriore / rear wheel (27 x 37 x 7)	(Sim.046699)
	ART. 7000	OR 210	(Sim. 6721)
	ART. 7001	OR 060	(Sim. 6706)
	ART. 7002	OR 160	(Sim. 6716)
	ART. 7003	OR 080	(Sim. 6708)

ART. 6653-V
 SERIE PARAOLI COMPLETA
 VERSIONE CON PARAOLIO
 LATO FRIZIONE/VOLANO
 IN VITON

COMPLETE SET OIL SEALS
 VERSION WITH VITON OIL SEALS
 CLUTCH/FLYWHEEL SIDE

CON PARAOLI / WITH OIL SEALS

CORTECO

SERIE COMPOSTA DA / SET COMPOSED OF:

	ART. 5906-V	lato frizione / clutch side (22,7 x 47 x 7V _m) in Viton Marrone / Brown Viton	(Sim.430391)
	ART. 5965-V	lato volano / flywheel side (20 x 32 x 7V _m) in Viton Marrone doppio labbro/Brown Viton-double lip	(Sim.430392)
	ART. 5910	ruota posteriore / rear wheel (27 x 37 x 7)	(Sim.046699)
	ART. 7000	OR 210	(Sim. 6721)
	ART. 7001	OR 060	(Sim. 6706)
	ART. 7002	OR 160	(Sim. 6716)
	ART. 7003	OR 080	(Sim. 6708)

VESPA PK 125 - PK 125 XL

ART. 6651
 SERIE PARAOLI COMPLETA
 COMPLETE SET OIL SEALS

CON PARAOLI / WITH OIL SEALS

CORTECO

SERIE COMPOSTA DA / SET COMPOSED OF:

	ART. 5906	lato frizione / clutch side (22,7 x 47 x 7)	(Sim.289305)
	ART. 5907-C	lato volano / flywheel side (24 x 35 x 6R)	(Sim.158962)
	ART. 5910	ruota posteriore / rear wheel (27 x 37 x 7)	(Sim.046699)
	ART. 7000	OR 210	(Sim. 6721)
	ART. 7001	OR 060	(Sim. 6706)
	ART. 7002	OR 160	(Sim. 6716)
	ART. 7003	OR 080	(Sim. 6708)

CON PARAOLI



KIT REVISIONE ALBERO MOTORE CRANKSHAFT REVISION KIT

VESPA PX PE 125-150-200 - PX PE ARCOBALENO



ART. **5180-KT**

KIT REVISIONE ALBERO MOTORE
CON PARAOLI BLU CORTECO

CRANKSHAFT REVISION KIT
WITH BLUE CORTECO OIL SEALS

KIT Composto da / Kit composed of:

CIF ART.	Pz/Pcs	Descrizione / Description
5912-C	1	paraolio lato frizione (Corteco) oil seal clutch side
5907-C	1	paraolio lato volano (Corteco) oil seal flywheel side
5829-8S	1	cuscinetto lato frizione bearing clutch side
5829	1	cuscinetto lato volano bearing flywheel side
7011-KT	1	Kit anelli OR / rings set



ART. **5180-KTV**

KIT REVISIONE ALBERO MOTORE

VERSIONE CON
PARAOLIO LATO FRIZIONE IN VITON

CRANKSHAFT REVISION KIT
VERSION WITH **CLUTCH SIDE OIL SEAL IN VITON**

KIT Composto da / Kit composed of:

CIF ART.	Pz/Pcs	Descrizione / Description
5912-LV	1	paraolio lato frizione (lamiera esterna - interno in Viton) oil seal, clutch side (sheet metal external external - internal in Viton)
5907-C	1	paraolio lato volano (Corteco) oil seal flywheel side
5829-8S	1	cuscinetto lato frizione bearing clutch side
5829	1	cuscinetto lato volano bearing flywheel side
7011-KT	1	Kit anelli OR / rings set



SERIE PARAOLI MOTORE

ENGINE OIL SEALS

CON PARAOLI **CORTECO**

VESPA PX 125-150 - PX ARCOBALENO



ART. 5699-C
 SERIE PARAOLI COMPLETA
 COMPLETE SET OIL SEALS
 CON PARAOLI / WITH OIL SEALS
CORTECO

SERIE COMPOSTA DA / SET COMPOSED OF:

	ART. 5912-C lato frizione / clutch side (31x62x5,8/4,3)	(Sim.131102)
	ART. 5907-C lato volano / flywheel side (24 x 35 x 6R)	(Sim.158962)
	ART. 5911-C ruota posteriore / rear wheel (27 x 47 x 6)	(Sim.130536)
	ART. 7000 OR 210 (Sim. 6721) ART. 7003 OR 080 (Sim. 6708) ART. 7008 OR 140 (Sim. 6714) ART. 7018 120x2,15 (Sim. 017781)	



ART. 5699-CV
 SERIE PARAOLI COMPLETA
 VERSIONE CON PARAOLIO
 LATO FRIZIONE IN VITON
 COMPLETE SET OIL SEALS
 VERSION WITH
 VITON OIL SEAL CLUTCH
 SIDE
 CON PARAOLI / WITH OIL SEALS
CORTECO

SERIE COMPOSTA DA / SET COMPOSED OF:

	ART. 5912-LV lato frizione / clutch side (lamiera esterna in Viton Marrone) (31 x 62 x 5,8 / 4,3 Vm)	(Sim.242550)
	ART. 5907-C lato volano / flywheel side (24 x 35 x 6R)	(Sim.158962)
	ART. 5911-C ruota posteriore / rear wheel (27 x 47 x 6)	(Sim.130536)
	ART. 7000 OR 210 (Sim. 6721) ART. 7003 OR 080 (Sim. 6708) ART. 7008 OR 140 (Sim. 6714) ART. 7018 120x2,15 (Sim. 017781)	

VESPA PX 200 ARCOBALENO



ART. 6649
 SERIE PARAOLI COMPLETA
 COMPLETE SET OIL SEALS
 CON PARAOLI / WITH OIL SEALS
CORTECO
 (Sim.154818)

SERIE COMPOSTA DA / SET COMPOSED OF:

	ART. 5912-C lato frizione / clutch side (31x62x5,8/4,3)	(Sim.131102)
	ART. 5907-C lato volano / flywheel side (24 x 35 x 6R)	(Sim.158962)
	ART. 5950 ruota posteriore / rear wheel (478498-8714) (30 x 47 x 6)	
	ART. 7000 OR 210 (Sim. 6721) ART. 7003 OR 080 (Sim. 6708) ART. 7008 OR 140 (Sim. 6714) ART. 7018 120x2,15 (Sim. 017781)	



ART. 6649-V
 SERIE PARAOLI COMPLETA
 VERSIONE CON PARAOLIO
 LATO FRIZIONE IN VITON
 COMPLETE SET OIL SEALS
 VERSION WITH
 VITON OIL SEALS CLUTCH
 SIDE
 CON PARAOLI / WITH OIL SEALS
CORTECO

SERIE COMPOSTA DA / SET COMPOSED OF:

	ART. 5912-LV lato frizione / clutch side (lamiera esterna in Viton Marrone) (31 x 62 x 5,8 / 4,3 Vm)	(Sim.242550)
	ART. 5907-C lato volano / flywheel side (24 x 35 x 6R)	(Sim.158962)
	ART. 5950 ruota posteriore / rear wheel (478498-8714) (30 x 47 x 6)	
	ART. 7000 OR 210 (Sim. 6721) ART. 7003 OR 080 (Sim. 6708) ART. 7008 OR 140 (Sim. 6714) ART. 7018 120x2,15 (Sim. 017781)	

CON PARAOLI



KIT REVISIONE ALBERO MOTORE

CRANKSHAFT REVISION KIT

VESPA 125 T5



ART. **5177-KTV**

KIT REVISIONE ALBERO MOTORE
VERSIONE CON
PARAOILIO LATO FRIZIONE IN VITON

CRANKSHAFT REVISION KIT
VERSION WITH **CLUTCH SIDE OIL SEAL IN VITON**

KIT Composto da / Kit composed of:

CIF ART.	Pz/Pcs	Descrizione / Description
5912-LV	1	paraolio lato frizione (lamiera esterna - interno in Viton) oil seal, clutch side (sheet metal external external - internal in Viton)
5907-C	1	paraolio lato volano (Corteco) oil seal flywheel side
5829-8S	1	cuscinetto lato frizione bearing clutch side
5823	1	cuscinetto lato volano bearing flywheel side
7011-KT	1	Kit anelli OR / rings set



ART. **6652**
SERIE PARAOLI COMPLETA
COMPLETE SET OIL SEALS
CON PARAOLI / WITH OIL SEALS
CORTECO
(Sim.154818)





SERIE COMPOSTA DA / SET COMPOSED OF:

	ART. 5912-L	lato frizione / clutch side (lamiera esterna) (31 x 62 x 5,8 / 4,3)	(Sim.242549)
	ART. 5907-C	lato volano / flywheel side (24 x 35 x 6R)	(Sim.158962)
	ART. 5957	ruota posteriore interno al carter (118058) rear wheel, internal to the crankcase (27 x 42 x 10)	
	ART. 7000	OR 210	(Sim. 6721)
	ART. 7003	OR 080	(Sim. 6708)
	ART. 7008	OR 140	(Sim. 6714)
	ART. 7018	120x2,15	(Sim. 017781)



ART. **6652-V**
SERIE PARAOLI COMPLETA
VERSIONE CON PARAOLIO
LATO FRIZIONE IN VITON
COMPLETE SET OIL SEALS
VERSION WITH
VITON OIL SEALS CLUTCH SIDE
CON PARAOLI / WITH OIL SEALS
CORTECO

SERIE COMPOSTA DA / SET COMPOSED OF:

	ART. 5912-LV	lato frizione / clutch side (lamiera esterna in Viton Marrone) (31 x 62 x 5,8 / 4,3 Vm)	(Sim.242550)
	ART. 5907-C	lato volano / flywheel side (24 x 35 x 6R)	(Sim.158962)
	ART. 5957	ruota posteriore interno al carter (118058) rear wheel, internal to the crankcase (27 x 42 x 10)	
	ART. 7000	OR 210	(Sim. 6721)
	ART. 7003	OR 080	(Sim. 6708)
	ART. 7008	OR 140	(Sim. 6714)
	ART. 7018	120x2,15	(Sim. 017781)



KIT REVISIONE ALBERO MOTORE

CRANKSHAFT REVISION KIT

CON PARAOLI **ROLF**

VESPA RALLY 180 - 200



ART. **5210-KT**

KIT REVISIONE ALBERO MOTORE
VERSIONE CON **PARAOLI ROLF**

CRANKSHAFT REVISION KIT
WITH **ROLF OIL SEALS**

KIT Composto da / Kit composed of:

CIF ART.	Pz/Pcs	Descrizione / Description
5912	1	paraolio ROLF lato frizione / oil seal clutch side
5943	1	paraolio ROLF lato volano / oil seal flywheel side
5829-8S	1	cuscinetto lato frizione / bearing clutch side
5823	1	cuscinetto lato volano / bearing flywheel side

ART. **6645**
SERIE PARAOLI COMPLETA
COMPLETE SET OIL SEALS
CON PARAOLI / WITH OIL SEALS
ROLF
VESPA RALLY 180 - 200

SERIE COMPOSTA DA / SET COMPOSED OF:

	ART. 5912	lato frizione / clutch side (31 x 62,5 x 6) ROLF	(Sim. 431122)
	ART. 5943	lato volano / flywheel side (24 x 40 x 7) ROLF	(Sim. 008708)
	ART. 5910-R	ruota posteriore / rear wheel (27 x 37 x 7) ROLF VESPA RALLY 180	(Sim. 046699)
	ART. 5911	ruota posteriore / rear wheel (27 x 47 x 6) ROLF VESPA RALLY 200	(Sim. 130536)
	ART. 7000	OR 210	(Sim. 6721)
	ART. 7003	OR 080	(Sim. 6708)
	ART. 7008	OR 140	(Sim. 6714)
	ART. 7018	120x2,15	(Sim. 017781)

VESPA SPRINT - SUPER - GTR - TS



ART. **5166-KTC**

KIT REVISIONE ALBERO MOTORE

VERSIONE CON **PARAOILI** **CORTECO**

CRANKSHAFT REVISION KIT

VERSION WITH **CORTECO** **OIL SEALS**

KIT Composto da / Kit composed of:

CIF ART.	Pz/Pcs	Descrizione / Description
5949-C	1	paraolio CORTECO lato frizione / oil seal clutch side
5947-AC	1	paraolio CORTECO lato volano / oil seal flywheel side
5829-8S	2	cuscinetto lato frizione e volano/bearings clutch/flywheel side
7000	1	Anellino OR 210 / O-ring (Sim.6721)
7003	1	Anellino OR 080 / O-ring (Sim.6708)
7008	2	Anellino OR 140 / O-ring (Sim.6714)
7018	1	Anello OR 120x2,15 / O-ring (Sim.017781)



ART. **5166-KTR**

KIT REVISIONE ALBERO MOTORE

VERSIONE CON **PARAOILI** **ROLF**

CRANKSHAFT REVISION KIT

VERSION WITH **ROLF** **OIL SEALS**

KIT Composto da / Kit composed of:

CIF ART.	Pz/Pcs	Descrizione / Description
5949-R	1	paraolio ROLF lato frizione / oil seal clutch side
5947-AR	1	paraolio ROLF lato volano / oil seal flywheel side
5829-8S	2	cuscinetto lato frizione e volano/bearings clutch/flywheel side
7000	1	Anellino OR 210 / O-ring (Sim.6721)
7003	1	Anellino OR 080 / O-ring (Sim.6708)
7008	2	Anellino OR 140 / O-ring (Sim.6714)
7018	1	Anello OR 120x2,15 / O-ring (Sim.017781)



SERIE PARAOLI MOTORE

ENGINE OIL SEALS



VESPA SPRINT - SPRINT VELOCE - GT - GTR - SUPER - GL 150



ART. 6646
 SERIE PARAOLI COMPLETA
 COMPLETE SET OIL SEALS
 CON PARAOLI / WITH OIL SEALS
ROLF

VESPA SPRINT 150 (VLB1T)
 VESPA SPRINT VELOCE
 VESPA GT 125 (VNL2T)
 VESPA GTR 125 (VNL2T)
 (VNA-VNB-VBA-VBB)
 VESPA SUPER
 VESPA GL 150 (VLA1T)

SERIE COMPOSTA DA / SET COMPOSED OF:

	ART. 5949-R lato frizione / clutch side (20 x 62 x 6,5) ROLF	(Sim. 049290)
	ART. 5947 lato volano / flywheel side (20 x 40 x 6FG) ROLF	(Sim.025180)
	ART. 5911 ruota posteriore / rear wheel (27 x 47 x 6) ROLF	(Sim.130536)

VESPA GL 150 - SPRINT 150 - VESPA 125/150 motore 2% (1959-1965)



ART. 6648-C
 SERIE PARAOLI COMPLETA
 COMPLETE SET OIL SEALS
 CON PARAOLI / WITH OIL SEALS
CORTECO

VESPA GL 150 (VLA1T '63-'64)
 SPRINT 150 (VLB1T '65-'74)
 VESPA 125/150 motore 2% ('59-'65)
 (Sim. 610203M)

SERIE COMPOSTA DA / SET COMPOSED OF:





	ART. 5949-C lato frizione / clutch side (20 x 62 x 6,5) CORTECO	(Sim. 049290)
	ART. 5947-AC lato volano / flywheel side (20 x 40 x 6FG) CORTECO	(Sim. 084644)
	ART. 5910 ruota posteriore / rear wheel (27 x 37 x 7) CORTECO	(Sim. 046699)
	ART. 7000 OR 210	(Sim. 6721)
	ART. 7018 120x2,15	(Sim. 017781)



ART. 6648-R
 SERIE PARAOLI COMPLETA
 COMPLETE SET OIL SEALS
 CON PARAOLI / WITH OIL SEALS
ROLF

VESPA GL 150 (VLA1T '63-'64)
 SPRINT 150 (VLB1T '65-'74)
 VESPA 125/150 motore 2% ('59-'65)
 (Sim. 610203M)

SERIE COMPOSTA DA / SET COMPOSED OF:

	ART. 5949-R lato frizione / clutch side (20 x 62 x 6,5) ROLF	(Sim. 049290)
	ART. 5947-AR lato volano / flywheel side (20 x 40 x 6FG) ROLF	(Sim. 084644)
	ART. 5910-R ruota posteriore / rear wheel (27 x 37 x 7) ROLF	(Sim. 046699)
	ART. 7000 OR 210	(Sim. 6721)
	ART. 7018 120x2,15	(Sim. 017781)

VESPA 98 (1946-1947) - VESPA 125 (1948-1952) FARO BASSO



ART. 5171-KT

KIT REVISIONE ALBERO MOTORE
CON PARAOLI **ROLF**

CRANKSHAFT REVISION KIT
WITH **OIL SEALS ROLF**



KIT Composto da / Kit composed of:

CIF ART.	Pz/Pcs	Descrizione / Description
5961	2	paraoli ROLF lato frizione/volano / oil seal clutch/flywheel side
16169-SKF	2	cuscinetti lato frizione e volano/bearings clutch/flywheel side

VESPA 125/150 - GS 150

ART. 6647-C

SERIE PARAOLI COMPLETA
COMPLETE SET OIL SEALS

CON PARAOLI / WITH OIL SEALS



VESPA 125 (VM1/2T '53-'54)
VESPA 125 (VN1/2 '54-'57)
VESPA (VNA 1/2T '58-'59)
VESPA 150 (VL1/2/3T '55-'56)
VESPA 150 (VB1T '57-'58)
VESPA GS 150 (VS1/2/3/4/5 '55-'61)

(Sim. 610052M001)



SERIE COMPOSTA DA / SET COMPOSED OF:

	ART. 5947-AC lato frizione / clutch side (20 x 40 x 6FG) CORTECO	(Sim. 084644)
	ART. 5947-AC lato volano / flywheel side (20 x 40 x 6FG) CORTECO	(Sim. 084644)
	ART. 5957 ruota posteriore / rear wheel (27 x 42 x 10) CORTECO	(Sim. 118058)

ART. 6647-R

SERIE PARAOLI COMPLETA
COMPLETE SET OIL SEALS

CON PARAOLI LATO FRIZIONE/VOLANO
WITH OIL SEALS,
CLUTCH/FLYWHEEL SIDE



VESPA 125 (VM1/2T '53-'54)
VESPA 125 (VN1/2 '54-'57)
VESPA (VNA 1/2T '58-'59)
VESPA 150 (VL1/2/3T '55-'56)
VESPA 150 (VB1T '57-'58)
VESPA GS 150 (VS1/2/3/4/5 '55-'61)

(Sim. 610052M001)



SERIE COMPOSTA DA / SET COMPOSED OF:

	ART. 5947-AC lato frizione / clutch side (20 x 40 x 6FG) ROLF	(Sim. 084644)
	ART. 5947-AC lato volano / flywheel side (20 x 40 x 6FG) ROLF	(Sim. 084644)
	ART. 5957 ruota posteriore / rear wheel (27 x 42 x 10) CORTECO	(Sim. 118058)



KIT REVISIONE ALBERO MOTORE

CRANKSHAFT REVISION KIT

VESPA GS 150 (VS1/2/3/4/5T)



ART. 5212-KT

KIT REVISIONE ALBERO MOTORE
CON **PARAOILI ROLF**
CRANKSHAFT REVISION KIT
WITH **ROLF OIL SEALS**

KIT Composto da / Kit composed of:

CIF ART.	Pz/Pcs	Descrizione / Description
5947	2	paraoli ROLF lato frizione/volano / oil seal clutch/flywheel side
5829-8S	2	cuscinetti lato frizione e volano/bearings clutch/flywheel side

VESPA GS 160 - VESPA 180 SS



ART. 5214-KT

KIT REVISIONE ALBERO MOTORE
CRANKSHAFT REVISION KIT

KIT Composto da / Kit composed of:

CIF ART.	Pz/Pcs	Descrizione / Description
5959	1	paraolio PHLE lato frizione / oil seal clutch side
5913	1	paraolio ROLF lato volano interno / oil seal flywheel internal side
5958	2	paraolio PHLE lato volano esterno/oil seal flywheel external side
5829-8S	1	cuscinetto lato frizione / bearing clutch side
5823	1	cuscinetto lato volano / oil seal flywheel side
7000	2	Anellino OR 210 / O-ring (Sim.6721)
7018	1	Anello OR 120x2,15 / ring (Sim.017781)



ART. 6643

SERIE PARAOILI COMPLETA

COMPLETE SET OIL SEALS

VESPA GS 160
VESPA 180 SS

SERIE COMPOSTA DA / SET COMPOSED OF:

	ART. 5959	lato frizione / clutch side (32 x 57/61 x 6FG) PHLE
	ART. 5913	lato volano interno / flywheel inside (30 x 40 x 7) ROLF
	ART. 5958	lato volano esterno / flywheel outside (24.9 x 45 x 5,5/6,5) PHLE
	ART. 5910-R	ruota posteriore / rear wheel (Sim.046699) VESPA 180 SS (27 x 37 x 7) ROLF
	ART. 5953	ruota posteriore / rear wheel VESPA GS 160 (30 x 40 x 7) CORTECO
	ART. 7000	OR 210 (Sim. 6721)
	ART. 7018	anello 120x2,15 (Sim. 017781)

VITI CARICO/SCARICO OLIO MOTORE

LOAD/UNLOAD ENGINE OIL SCREW



ART. 10286-KT

KIT VITI CARICO/SCARICO OLIO MOTORE
SCREW KIT LOAD/UNLOAD ENGINE OIL

VESPA PX PE - VESPA PK



ART. 10285-KT

KIT VITI CARICO/SCARICO OLIO MOTORE
SCREW KIT, LOAD/UNLOAD ENGINE OIL

VESPA TUTTI MODELLI DAL 1946 AL 1976
VESPA 50 - PRIMAVERA FINO A FINE PRODUZIONE
APE 50



ART. 10281-VS

VITE TE SCARICO OLIO / SCREW UNLOAD ENGINE OIL (Sim. 138345)
PER VESPA PX PE - PK

CARICO/SCARICO OLIO PER / LOAD/UNLOAD ENGINE OIL FOR:
VESPA TUTTI MODELLI DAL 1946 AL 1976
VESPA 50 - PRIMAVERA FINO A FINE PRODUZIONE
APE 50



ART. 10281-V

VITE CARICO OLIO / SCREW LOAD ENGINE OIL (Sim. 030280)
PER VESPA PX PE - PK

VITE TAPPO OLIO CARTER POSTERIORE SCATOLA INGRANAGGI:
SCREW FOR OIL PLUG REAR CARTER GEAR BOX
PER CIAO-BRAVO-SI'



ART. 10281-R

GUARNIZIONE PER VITI CARICO/SCARICO OLIO (Sim. 000397)
GASKET FOR LOAD/UNLOAD ENGINE OIL SCREWS
PER VESPA TUTTI MODELLI DAL 1946 AL 1976
VESPA 50 - PRIMAVERA FINO A FINE PRODUZIONE
VESPA PX PE - PK - APE 50

GUARNIZIONE PER VITE CARICO OLIO MOZZO POSTERIORE
GASKET FOR LOAD OIL SCREW, REAR HUB
PER PIAGGIO CIAO - BRAVO - SI'



FOGLI CARTA GUARNIZIONI

GASKETS PAPERS

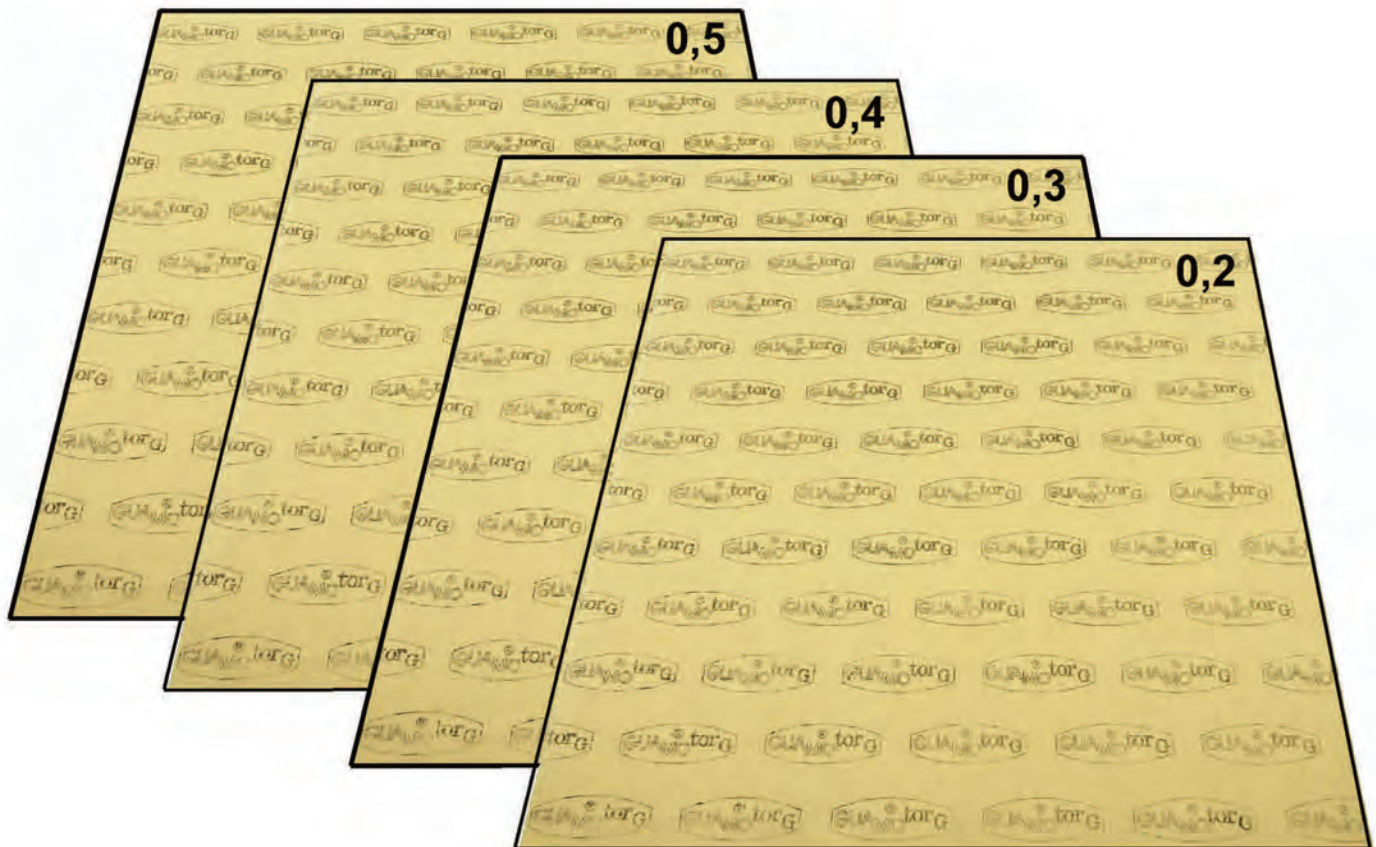

ART. **9396-KT**

KIT 4 FOGLI CARTA GUARNIZIONI " GUAMOTOR "

" GUAMOTOR " GASKETS PAPERS KIT, 4 SHEETS

KIT COMPOSTO DA / SET COMPOSED OF:

FOGLIO mm. 480x480 **SPESSORE / THICKNESS PAPER 0,2**
FOGLIO mm. 480x480 **SPESSORE / THICKNESS PAPER 0,3**
FOGLIO mm. 480x480 **SPESSORE / THICKNESS PAPER 0,4**
FOGLIO mm. 480x480 **SPESSORE / THICKNESS PAPER 0,5**

SERIE GUARNIZIONI MOTORE
ENGINE GASKETS SET

VESPA 50 - 90 - PRIMAVERA - ET3

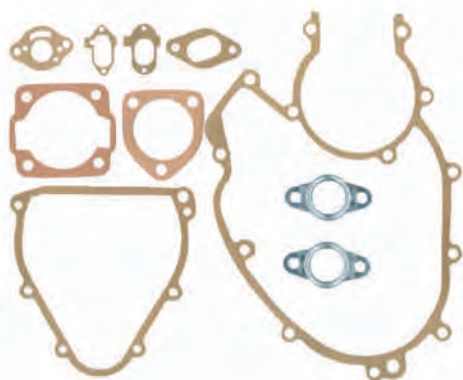

ART. **9382**

SERIE GUARNIZIONI

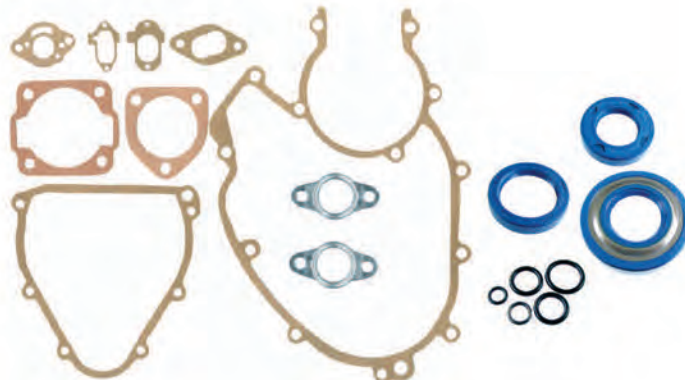

ART. **9382-CP**

SERIE COMPLETA DI PARAOLI+ANELLINI OR
COMPLETE SET WITH OIL SEALS AND O-RING

VESPA PK 50 - PK 50 XL - RUSH

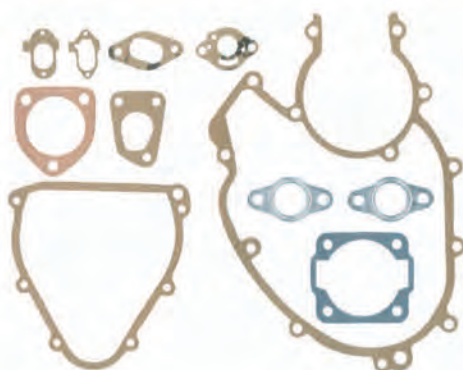

ART. **9383**

SERIE GUARNIZIONI

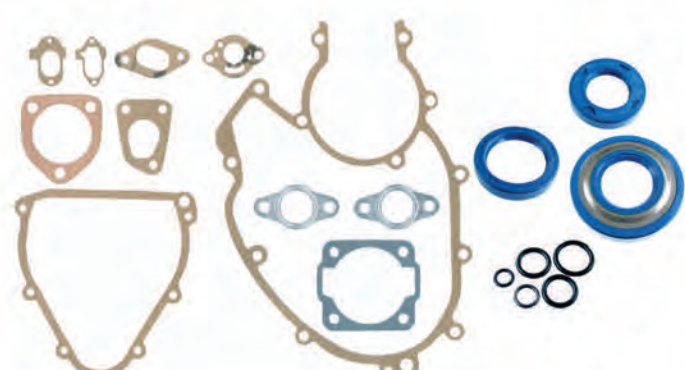

ART. **9383-CP**

SERIE COMPLETA DI PARAOLI+ANELLINI OR
COMPLETE SET WITH OIL SEALS AND O-RING



SERIE GUARNIZIONI MOTORE

ENGINE GASKETS SET

VESPA PX 125/150 - PX 125/150 ARCOBALENO - SPRINT VELOCE - GTR

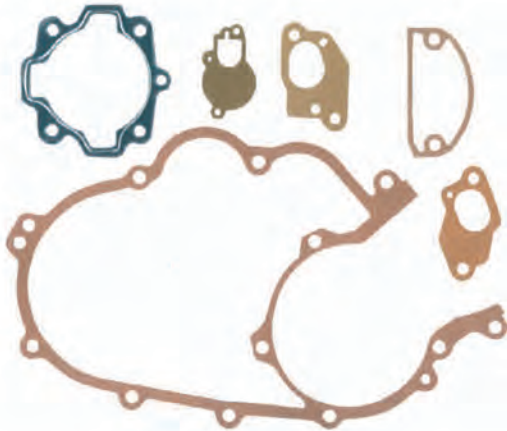

ART. **9387**

SERIE GUARNIZIONI

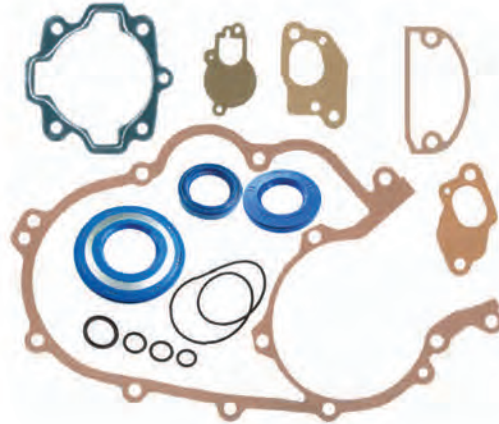

ART. **9387-CP**

SERIE COMPLETA DI PARAOLI+ANELLINI OR
COMPLETE SET WITH OIL SEALS AND O-RING

VESPA PX 125/150 ARCOBALENO - VESPA COSA 125/150
CON MISCELATORE SEPARATO / WITH SEPARATED MIX



ART. **9390**

SERIE GUARNIZIONI

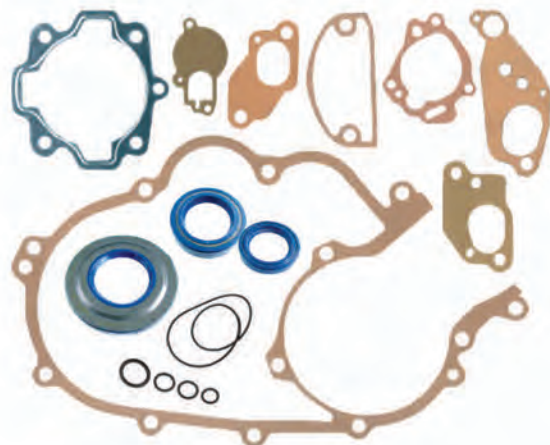

ART. **9390-CP**

SERIE COMPLETA DI PARAOLI+ANELLINI OR
COMPLETE SET WITH OIL SEALS AND O-RING

SERIE GUARNIZIONI MOTORE
ENGINE GASKETS SET

VESPA 125 T5
CON MISCELATORE SEPARATO / *SEPARATED MIX*



ART. **9388**

SERIE GUARNIZIONI

VESPA PE 200 - PE 200 ARCOBALENO
VESPA RALLY 200

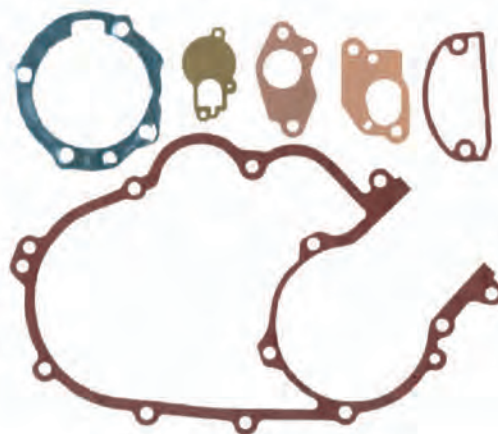

ART. **9389**

SERIE GUARNIZIONI

VESPA COSA - PE 200 ARCOBALENO
CON MISCELATORE SEPARATO / *SEPARATED MIX*



ART. **9391**

SERIE GUARNIZIONI

VESPA RALLY 200
CON MISCELATORE SEPARATO / *SEPARATED MIX*



ART. **9392**

SERIE GUARNIZIONI



SERIE GUARNIZIONI MOTORE

ENGINE GASKETS SET

VESPA 2%
(VESPA 125/150 SUPER - SPRINT - GT 125)

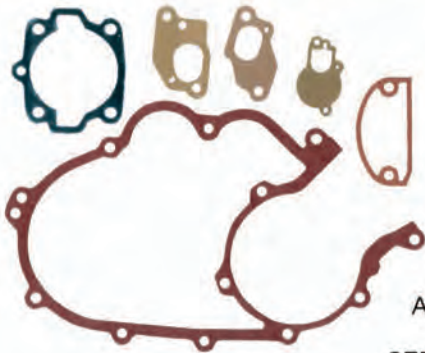

ART. **9392-A**
SERIE GUARNIZIONI

VESPA 2% (125 VNA/VNB dal 1958->1965)
(VESPA 150 dal 1959->1965 - VESPA GL 150)



ART. **9392-B**
SERIE GUARNIZIONI

VESPA 125 dal 1953->1957
VESPA 150 dal 1954->1958



ART. **9392-C**
SERIE GUARNIZIONI

VESPA 125 dal 1948->1952

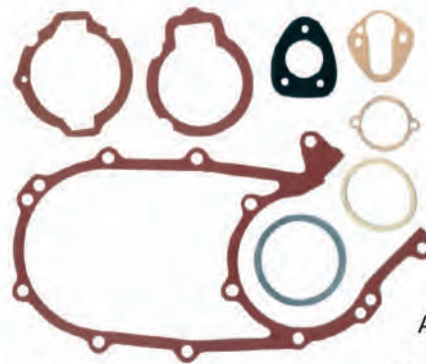

ART. **9392-D**
SERIE GUARNIZIONI

VESPA GS 150 (1956-1961)
(VS 2/3/4/5)



ART. **9392-E**
SERIE GUARNIZIONI

VESPA GS 160
VESPA 180 SS



ART. **9392-F**
SERIE GUARNIZIONI

GUARNIZIONI

GASKETS

ART. **9187**

GUARNIZIONE
per raccordo aspirazione
UNION PIPE GASKET

VESPA 50 - 90 - 125 PRIMAVERA - ET3
VESPA PK 50 - 125 (1ª SERIE A 2 FORI)



ART. **9188**

GUARNIZIONE
per raccordo aspirazione
UNION PIPE GASKET

VESPA PK XL(2ª SERIE A 3 FORI)



ART. **9204-SM**

GUARNIZIONE
fra base carburatore e vaschetta

between float chamber cover and carburettor

VESPA PX 125 - 150
SENZA MISCELATORE / *WITHOUT MIX*



ART. **9205-SM**

GUARNIZIONE
fra base carburatore e vaschetta

between float chamber cover and carburettor

VESPA RALLY 200 - COSA 200 - PE 200 - 125 T5
SENZA MISCELATORE / *WITHOUT MIX*



ART. **9200-PX**

GUARNIZIONE
fra base carburatore e vaschetta

between float chamber cover and carburettor

VESPA PX 125/150-PE 200 ARCOBALENO
VESPA COSA 125/150/200
CON MISCELATORE / *WITH MIX*



ART. **9200-T5**

GUARNIZIONE
fra base carburatore e vaschetta

between float chamber cover and carburettor

VESPA 125 T5
CON MISCELATORE / *WITH MIX*



ART. **9200-RA**

GUARNIZIONE
fra base carburatore e vaschetta

between float chamber cover and carburettor

VESPA RALLY 200
CON MISCELATORE / *WITH MIX*



ART. **9200-MIX**

GUARNIZIONE miscelatore

mix gasket

VESPA PX 125-150 PE 200 - RALLY 200
VESPA COSA 125-150-200 - 125 T5



ART. **9203**

GUARNIZIONE
fra vaschetta carburatore e carter

between float chamber cover and carter

VESPA PX 125/150 - PE 200 - 125 T5 - RALLY 200
VESPA COSA 125/150/200
CON E SENZA MISCELATORE / *WITH AND WITHOUT MIX*



ART. **9189**

GUARNIZIONE
flangia porta cuscinetti mozzo posteriore
rear wheel hub bearings flange

VESPA 50 - 90
VESPA 125 PRIMAVERA ET3
VESPA PK 50/125
VESPA PK 50/125 XL



ART. **9197**

GUARNIZIONE
coperchio frizione
clutch cover gasket

VESPA 50
VESPA 125 PRIMAVERA-ET3
VESPA PK

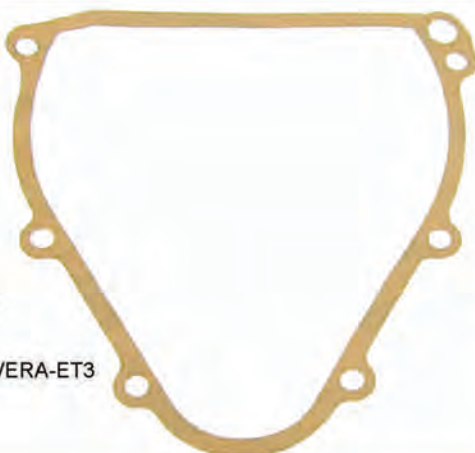

ART. **9198**

GUARNIZIONE
per preselettore cambio
selector gear gasket

VESPA PX PE
TUTTI MODELLI / *ALL MODELS*



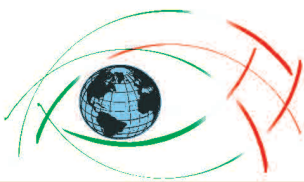

GUARNIZIONI BASAMENTO CILINDRO

CYLINDER GASKETS

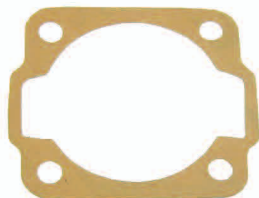

ART. 9182

GUARNIZIONE IN CARTA
PAPER GASKET

VESPA 50 - 90
125 PRIMAVERA - ET3
VESPA PK - PK XL

ART. 9182-A

GUARNIZIONE IN ALLUMINIO
ALUMINIUM GASKET

VESPA 50 - 90
125 PRIMAVERA - ET3
VESPA PK - PK XL - VESPA ET4

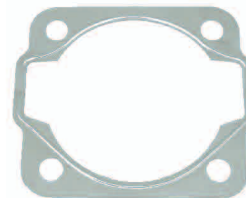

ART. 9182-PX

GUARNIZIONE

VESPA PX 125 / 150
VESPA COSA 125 / 150

ART. 9182-T5

GUARNIZIONE

VESPA 125 T5

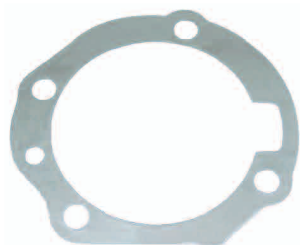
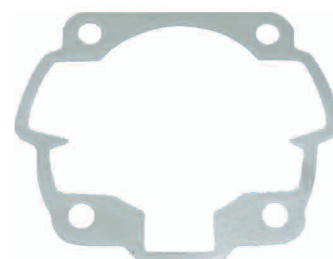

ART. 9182-PE

GUARNIZIONE

VESPA PE 200
VESPA RALLY 200
VESPA COSA 200

ART. 9186

GUARNIZIONE

VESPE 2%
VESPA 125 VNA-VNB dal '58 -> '65
VESPA 150 dal '59 -> '65
VESPA 125/150 SUPER
VESPA SPRINT - GT 125
VESPA GL 150

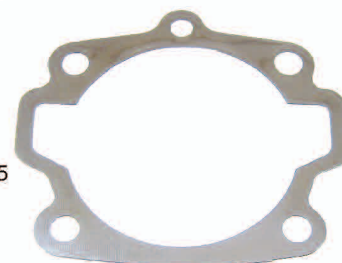

GUARNIZIONI SCARICO

HEXAUST UNION PIPE GASKETS



ART. 5045-M

GUARNIZIONE SCARICO
MAGGIORATA
OVERSIZE GASKET

(CON FORI / WITH HOLES Ø mm. 8)

VESPA 50 - 125 PRIMAVERA - ET3
VESPA PK 50 - VESPA HP

(Sim. 112420 - 289008)



ART. 5045-MA

GUARNIZIONE SCARICO
IN ALLUMINIO MAGGIORATA
ALUMINIUM OVERSIZE GASKET

(CON FORI / WITH HOLES Ø mm. 8)

VESPA 50 - 125 PRIMAVERA - ET3
VESPA PK 50 - VESPA HP

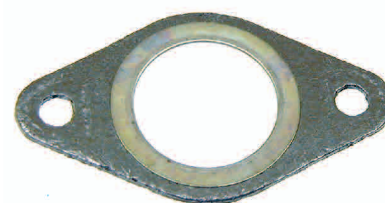

ART. 6237

GUARNIZIONE SCARICO

VESPA PK 125 - PK 125 XL

(Sim. 288838 ex 222209)

GUARNIZIONI SERBATOIO

TANK GASKETS

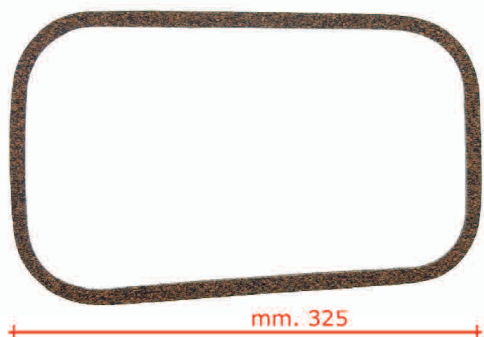

ART. 9206

GUARNIZIONE SERBATOIO CARBURANTE
SUGHERO-GOMMA (spessore mm.4)

*GASKET BETWEEN TANK AND FRAME,
CORK-RUBBER MATERIAL (thickness mm.4)*

VESPA 125 (VM1-VM2 '53-'54)

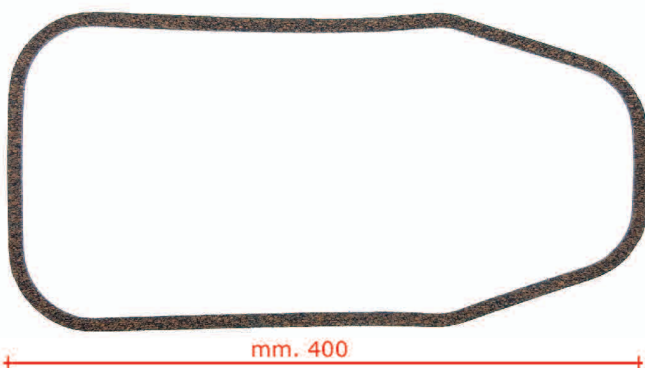

ART. 9207

GUARNIZIONE SERBATOIO CARBURANTE
SUGHERO-GOMMA (spessore mm.4)

*GASKET BETWEEN TANK AND FRAME
CORK-RUBBER MATERIAL (thickness mm.4)*

VESPA 125 (VN1-VN2)
VESPA 150 (VL2-3-VB1)

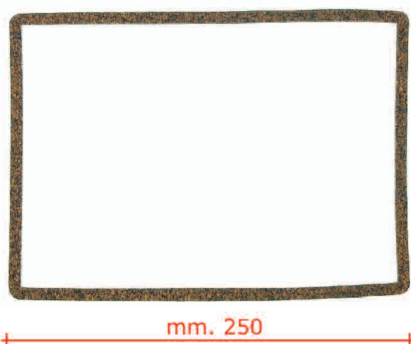

ART. 9208

GUARNIZIONE SERBATOIO CARBURANTE
SUGHERO-GOMMA (spessore mm.4)

*GASKET BETWEEN TANK AND FRAME
CORK-RUBBER MATERIAL (thickness mm.4)*

VESPA 125 BACCHETTA (V1/V15 '48-'50)
VESPA 125 (CAMBIO A FILO / WIRE GEAR) (V30/33 '51-'52)

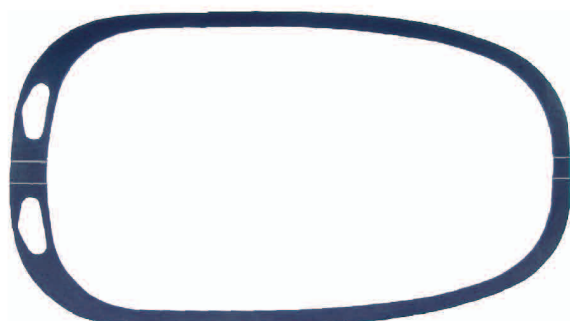

ART. 9209

GUARNIZIONE SERBATOIO CARBURANTE IN GOMMA (Sim.159804)

*GASKET BETWEEN TANK AND FRAME
RUBBER MATERIAL*

VESPA 125/150 DAL1960

VESPA GT 125-TS 125-GL 150-SUPER-GS 160-180 SS-RALLY
VESPA PX 125 (DAL/FROM 1998) - VESPA PX EU2 125 ('01-'07)
VESPA PX 150 (DAL/FROM 2011)
VESPA PX 30 ANNI 125 ('07-'08)
VESPA PXE ARCOBALENO 125 ('81-'97)
VESPA 125 T5 ('85-'89)



FRIZIONI CLUTCHES



- ART. **5036** CHIAVETTA **mm. 3 x 5** (Sim. 000267)
LATO VOLANO / FLYWHEEL SIDE : VESPA 50-PRIM.-ET3-PK- PK XL-FL2-PX PE
LATO FRIZIONE / CLUTCH SIDE : VESPA 50-PRIM.-ET3-PK- PK XL-FL2
- ART. **5037** CHIAVETTA **mm. 4 x 6,5** (Sim. 000097)
LATO FRIZIONE / CLUTCH SIDE : VESPA PX PE
- ART. **5038** CHIAVETTA **mm. 3 x 3** (Sim. 011753)
PER INGRANAGGIO QUADRUPLO / SHAFT CLUSTER
VESPA 50 - PRIMAVERA - ET3 - PK - PX XL - FL2



- ART. **5187**
DADO VOLANO / FLYWHEEL NUT
M10x1,5 - CHIAVE 14
VESPA 50 - 90 - 125 PRIMAVERA - ET3
VESPA PK - PK FI2
(Sim. 220010)



- ART. **5188**
DADO VOLANO / FLYWHEEL NUT
M11x1,5 - CHIAVE 14
VESPA SUPER - SPRINT - GS 150
VESPA 150 2% - VESPA 125-150 ('53-'58)
(Sim. S1544)

VESPA 50/90/125 PRIMAVERA - ET3 - PK - PK XL - PK FL2



- ART. **6630-KT**
KIT DADI + RONDELLE
FRIZIONE / CP. PRIMARIA
KIT NUTS + WASHERS
CLUTCH / GEAR SET



- ART. **5186** DADO FISSA PIGNONE COPPIA
PRIMARIA ALBERO MOTORE
LATO FRIZIONE
NUT, SEC. GEAR SET
CRANKSHAFT CLUTCH SIDE
M12x1,5 - CHIAVE 19
(Sim. 1510)



- ART. **5189** DADO FRIZIONE / CLUTCH NUT
M10x1,5 - CHIAVE 17
(Sim. 1508)



- ART. **6624** RONDELLA BLOCCA DADO
PIGNONE COPPIA PRIMARIA
WASHER, SEC. PINION FOR GEAR SET
(Sim. 1821)



- ART. **6625** RONDELLA BLOCCA DADO FRIZIONE
WASHER, SEC. CLUTCH NUT
(Sim. 244297)

FRIZIONI CLUTCHES

VESPA 50 - 125 PRIMAVERA - ET3 - PK e PK XL 50/125 - APE 50



ART. **5584-C**

NORMALE

GRUPPO FRIZIONE COMPLETO MONTATO
(N. 3 DISCHI SUGHERO + 2 IN ACCIAIO)

CLUTCH ASSY
(N.3 CORK DISCS + 2 STEEL DISCS)



ART. **5584-SRC**

SERIE DISCHI FRIZIONE NORMALE COMPLETA
(N. 3 DISCHI SUGHERO + 2 IN ACCIAIO + MOLLA NORMALE)

CLUTCH DISC, COMPLETE SET
(N. 3 CORK DISCS + 2 STEEL DISCS + NORMAL SPRING)

SPESSORE DISCO SUGHERO / CORK DISC THICKNESS mm. 2,6
SPESSORE DISCO FERRO / IRON DISC THICKNESS mm. 1,5



ART. **5584**

SERIE DISCHI FRIZIONE NORMALE (N. 3 PZ)

CLUTCH DISC, SET (No. 3 PCS.)

SPESSORE DISCO SUGHERO / CORK DISC THICKNESS mm. 2,6

CONFEZIONE/PACK 10 SERIE/SET (nr. 30 dischi/discs)

(Sim. 79399)



ART. **5584-SET**

SERIE DISCHI FRIZIONE NORMALE (N. 3 PZ.)

CLUTCH DISC, SET (No. 3 PCS.)

SPESSORE DISCO SUGHERO / CORK DISC THICKNESS mm. 2,6

Nr. 1 SERIE/SET (3 dischi/discs)

(Sim. 79399)



FRIZIONI CLUTCHES

VESPA 50 - 125 PRIMAVERA - ET3 - PK e PK XL 50/125 - APE 50



ART. **5581**

MODIFICATO

GRUPPO COMPLETO MONTATO
(N. 4 DISCHI SUGHERO + 3 IN ACCIAIO)

CLUTCH ASSY
(N. 4 CORK DISCS + 3 STEEL DISCS)



ART. **5580**

MODIFICA

SERIE DISCHI FRIZIONE
(N. 4 DISCHI SUGHERO + 3 ACCIAIO + MOLLA RINFORZATA)

CLUTCH DISC COMPLETE SET
(N. 4 CORK DISCS + 3 STEEL DISCS + REINFORCED SPRING)

SPESSORE DISCO SUGHERO / CORK DISC THICKNESS mm.2
SPESSORE DISCO FERRO / IRON DISC THICKNESS mm.0,8

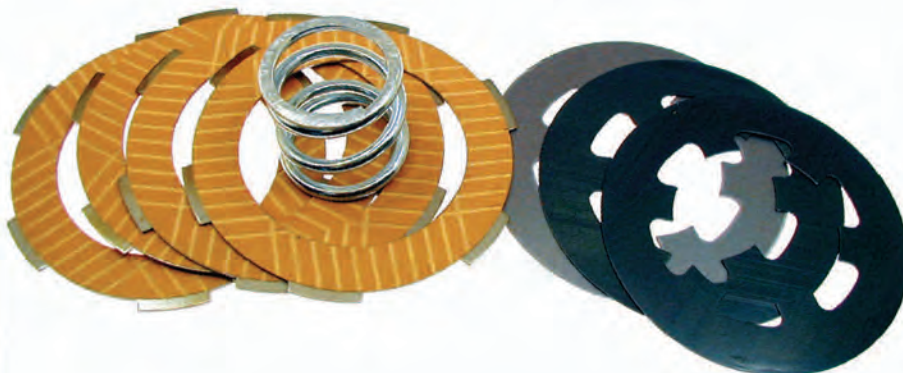

ART. **5580-RC**

SERIE DISCHI FRIZIONE
RACING / CARBONIO
(N. 4 DISCHI RIVESTITI + 3 IN ACCIAIO
+ 1 MOLLA)

CLUTCH DISCS SET
RACING / CARBON
(N. 4 COATED DISCS + 3 STEEL
+ 1 SPRING)

FRIZIONI CLUTCHES

VESPA 50 - 125 PRIMAVERA - ET3 - PK e PK XL 50/125 - APE 50



ART. 5602
CAMPANA INTERNA
PORTA DISCHI FRIZIONE
CLUTCH DRUM

(Sim. 79497)



ART. 5587
MOLLA FRIZIONE
NORMALE
CLUTCH NORMAL SPRING
ALTEZZA / HEIGHT mm. 37

(Sim. 112390)



ART. 5587-M
MOLLA FRIZIONE
MODIFICATA RINFORZATA
CLUTCH REINFORCED SPRING
ALTEZZA / HEIGHT mm. 50

(Sim. 112390 ex 112490)



ART. C00120
DISCO SPINGI MOLLA FRIZIONE
CLUTCH DISC

(Sim. 79469)



ART. C00123
DISCO FRONTALE
PER CHIUSURA GRUPPO FRIZIONE
DISC SEC. CLUTCH

(Sim. 79476)



ART. C00124
DISCO SFUSO CONDOTTO
IN FERRO NORMALE
CLUTCH DISC IN NORMAL IRON
(X SR.DISCHI FRIZIONE
CIF art. 5584-C e 5584-SRC)



ART. C00127
RACCOGLITORE OLIO
PER GRUPPO FRIZIONE
HOLD OIL FOR CLUCHT ASSY
(Sim. 150508)



ART. C00122
ANELLO ELASTICO
PER CHIUSURA DISCO FRIZIONE
OUTER DRIVING DISC CIRCLIP
(Sim. 079474)



SERIE PIATTELLI

CLUTCH PRESSURE PLATE SET

VESPA 50 - 90



ART. **5590**
SERIE PIATTELLO COMPLETA
(PIATTELLO+RALLINO+MOLLA)
CLUTCH PRESSURE PLATE SET
VESPA 50 - 90



ART. **5595**
RALLINO / PLUNGER
(Sim. 78543)



ART. **5588**
MOLLA RITEGNO
SPRING CLIP
(Sim. 14457)

VESPA 125 PRIMAVERA - ET3 - PK - PK XL - RUSH - N



ART. **5590-A**
SERIE PIATTELLO COMPLETA
(PIATTELLO+RALLINO+MOLLA)
CLUTCH PRESSURE PLATE SET
VESPA 125 PRIMAVERA - ET3
VESPA PK - PK XL - RUSH - N



ART. **5595-A**
RALLINO / PLUNGER
(Sim. 1650195)



ART. **5588**
MOLLA RITEGNO
SPRING CLIP
(Sim. 14457)

FRIZIONI CLUTCHES

VESPA FL - FL2 50/125 - RUSH - HP - N (3 VEL./SPEED) - APE 50 FL2



ART. **5578**

NORMALE

GRUPPO FRIZIONE COMPLETO MONTATO

CLUTCH ASSY, NORMAL VERSION

(Sim. 298935)



ART. **5578-M7**

MODIFICATO

GRUPPO COMPLETO MONTATO
(N. 4 DISCHI SUGHERO + 3 IN ACCIAIO)

CLUTCH ASSY, MODIFIED
(N. 4 CORK DISCS + 3 STEEL DISCS)



ART. **5648-FLR**

MOLLA FRIZIONE RINFORZATA / CLUTCH REINFORCED SPRING

(Sim. 289613)



ART. **5582**

SERIE DISCHI FRIZIONE NORMALE
(N. 3 DISCHI SUGHERO)

CLUTCH DISCS SET (N.3 CORK DISCS)

(Sim. 285974)



ART. **5583**

MODIFICA

SERIE DISCHI FRIZIONE

(N. 4 DISCHI SUGHERO + 3 DISCHI ACCIAIO + 6 MOLLE RINFORZATE)

CLUTCH DISC COMPLETE SET

(N. 4 CORK DISCS + 3 STEEL DISCS + 6 REINFORCED SPRINGS)



FRIZIONI CLUTCHES

VESPA FL - FL2 50/125 - RUSH - HP - N (3 VEL./SPEED) - APE 50 FL2

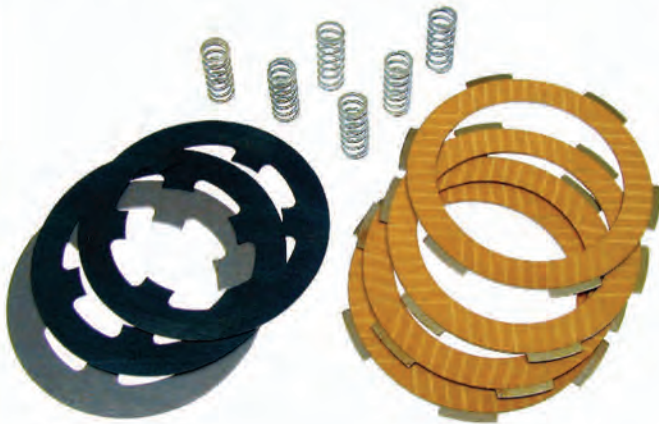

ART. **5583-RC**

SERIE DISCHI FRIZIONE **RACING/CARBONIO**
(N.4 DISCHI RIVESTITI + 3 IN ACCIAIO + 6 MOLLE)

CLUTCH DISCS SET **RACING/CARBON**
(N.4 COATED DISCS + 3 STEEL + 6 SPRINGS)

VESPA FL - RUSH - N



ART. **5602-FL**

CAMPANA INTERNA PORTA DISCHI FRIZIONE
CLUTCH DRUM

(SIM. 286012)



ART. **5597**

SERIE PIATTELLO COMPLETA
(PIATTELLO + RALLINO + MOLLA)
CLUTCH PRESSURE PLATE SET



ART. **5595-FL**

RALLINO SFUSO / PLUNGER

(SIM. 286305)



ART. **5588-FL**

MOLLA RITEGNO/ SPRING CLIP

(SIM. 286406)

CAMBIO

GEAR SPEED



ART. 6510-KT

KIT CAMBIO

GEAR SPEED SET

VESPA 50 - 50 S - 125 PRIMAVERA - ET3
(4 velocità / speed)

MODIFICA PER / MODIFICATION FOR:
VESPA RUSH - N - 50 FL

KIT composto da / KIT composed of:

N. 1 crociera 4 innesti	/ 4 speed selector	(CIF art. 5067)
N. 1 ingranaggio quadruplo	/ gear cluster	(CIF art. 6510)
N. 1 ruota dentata z 46	/ toothed gear speed	(CIF art. 6516)
N. 1 ruota dentata z 50	/ toothed gear speed	(CIF art. 6517)
N. 1 ruota dentata z 54	/ toothed gear speed	(CIF art. 6518)
N. 1 ruota dentata z 58	/ toothed gear speed	(CIF art. 6519)
N. 1 rondella fermo	/ washer sec. pinion	(CIF art. 6624)

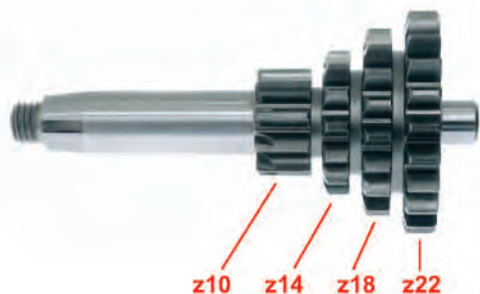

ART. 6510

INGRANAGGIO QUADRUPLO (4 VELOCITA')

GEAR CLUSTER (4 SPEED)

VESPA 50-90-PRIMAVERA-ET3
VESPA PK 50 - PK XL 50/125
VESPA FL2 HP 50 - FL 125

(Sim. 112377)

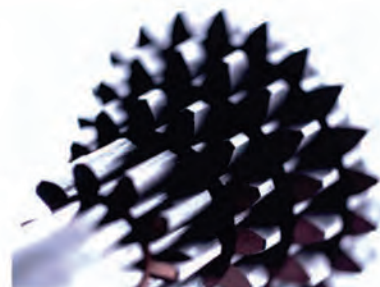

VESPA 50-90-125 PRIMAVERA-ET3 - PK 50 - PK XL 50/125 - FL2 HP 50 - FL 125



ART. 6519

INGRANAGGIO **z 58**
1ª VELOCITA'

GEAR 1ª SPEED

(Sim. 134903)



ART. 6518

INGRANAGGIO **z 54**
2ª VELOCITA'

GEAR 2ª SPEED

(Sim. 134904)



ART. 6517

INGRANAGGIO **z 50**
3ª VELOCITA'

GEAR 3ª SPEED

(Sim. 134905)



ART. 6516

INGRANAGGIO **z 46**
4ª VELOCITA'

GEAR 4ª SPEED

(Sim. 134906)



CP. TRASMISSIONI PRIMARIE

GEARS SET

SENZA PARASTRAPPI / WITHOUT CUSH GEAR



ART. **5980** **z 18 x 67**
dentatura **ELICOIDALE** (senza parastrappi)
HELICOIDAL cogs (without cush gear)
VESPA PK RUSH - N- PK FL2



ART. **5986** **z 22 x 63**
dentatura **ELICOIDALE** (senza parastrappi)
HELICOIDAL cogs (without cush gear)
VESPA 50 V - HP - VESPA 90



ART. **5987** **z 21 x 76**
dentatura **DIRITTA** (senza parastrappi)
STRAIGHT cogs (without cush gear)
VESPA 50 V - HP - VESPA 90
VESPA 50 V - FL2 ultimo tipo

CON PARASTRAPPI / WITH CUSH GEAR



ART. **5990** **z 18 x 67**
dentatura **ELICOIDALE** (con parastrappi)
HELICOIDAL cogs (with cush gear)
VESPA 50 R-L-N-PKS XL - APE 50



ART. **5981** **z 22 x 63**
dentatura **ELICOIDALE** (con parastrappi)
HELICOIDAL cogs (with cush gear)
VESPA 50 - 90 - PK 50



ART. **5982** **z 24 x 61**
dentatura **ELICOIDALE** (con parastrappi)
HELICOIDAL cogs (with cush gear)
VESPA 125 PRIMAVERA - ET3 - PK 125 ...



ART. **5983** **z 24 x 72**
dentatura **DIRITTA** (con parastrappi)
STRAIGHT cogs (with cush gear)
VESPA 50 - 90 - PK 50



ART. **5984** **z 27 x 69**
dentatura **DIRITTA** (con parastrappi)
STRAIGHT cogs (with cush gear)
VESPA 125 PRIMAVERA - ET3 - PK 125 ...



ART. **5985** **z 29 x 68**
dentatura **DIRITTA rapporti lunghi**
(con parastrappi)
STRAIGHT cogs - long ratio (with cush gear)
VESPA 50-90-125 PRIM.-ET3 - PK 50-125



ART. **16005** CUSCINETTO SKF 25 x 47 x 8 (Sim.007130)
PER CARTER ALLOGGIO CAMPANA FRIZIONE
FOR CLUTCH DRUM HOUSING CARTER
VESPA 50 - 90 - 125 PRIMAVERA - ET3 - PK - APE 50

SERIE PARASTRAPPI COMPLETA

CUSH GEAR COMPLETE SET



ART. **5070**

SERIE PARASTRAPPI COMPLETA

COMPLETE CUSH GEAR SET

VESPA 50 - 90 - 125 PRIMAVERA - ET3
VESPA PK - PK XL

RICAMBI ASSE RUOTA POST.

REAR WHEEL AXLE SPARE PARTS



ART. **5035**

DADO FRESATO Ø 14 - CHIAVE 22 FISSA RUOTA POSTERIORE

(Sim. 2314)

NUT SEC. REAR WHEEL, Ø 14 - KEY 22

VESPA tutti modelli fino a / all models till to ARCOBALENO

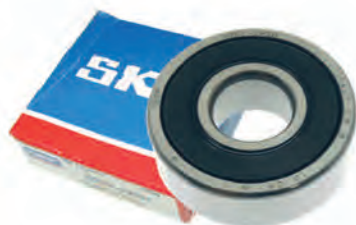

ART. **16204-2RS**

CUSCINETTO (SKF 6204-2RS) (20-47-14)
SCHERMATO DA ENTRAMBI I LATI X ASSE RUOTA POSTERIORE

(Sim. 434735)

BEARING (SCREENED TWO SIDES) FOR REAR WHEEL AXLE

VESPA E SCOOTER tutti modelli / for all models



RICAMBI ASSE RUOTA POST.

REAR WHEEL AXLE SPARE PARTS



ART. 6622-KT

KIT SCODELLINO + DADO + COPPIGLIA
PER ASSE RUOTA POSTERIORE

SET OF CAP SEC NUT + NUT + SPLIT PIN
FOR REAR WHEEL AXLE

VESPA PK - PK XL - N - FL2
VESPA PX PE ARCOBALENO
SCOOTER PIAGGIO - GILERA



ART. 6622

SCODELLINO
PER ASSE RUOTA POSTERIORE

CAP SEC NUT REAR WHEEL AXLE
(Sim. 194423)



ART. 6623

DADO
PER ASSE RUOTA POSTERIORE

REAR WHEEL AXLE NUT
(Sim. 194424)



ART. 6627

COPPIGLIA
PER ASSE RUOTA POSTERIORE

SPLIT PIN FOR REAR WHEEL AXLE

ALBERO CAMBIO

DRIVE SHAFT



Ø mm.16x1,25

ART. 6504

ALBERO CAMBIO

(Sim.182541)

DRIVE SHAFT

VESPA 50 - 90 - PRIMAVERA - ET3 2ª SERIE
VESPA PK 50 - PK XL 50-125 - RUSH 50 - N 50
VESPA FL 50-125 - FL2 HP 50 - P 125 ETS



ART. 5818

ASTUCCIO A RULLI (16 x 22 x 12)
PER ALBERO CAMBIO

(Sim.137731)

ROLLER CAGE FOR DRIVE SHAFT

VESPA 50 - 90 - PRIMAVERA - ET3
VESPA PK - PK XL - FL - RUSH - N

PRESELETTORI CAMBIO

SELECTORS GEAR SPEED



ART. 5052-OR

PRESELETTORE CAMBIO

(Sim.121536)

1 CAVA PER 1 ANELLO O-RING (come originale)
1 GROOVE FOR 1 O-RING (as original)

VESPA 50 - 125 - PRIMAVERA - Et3



ART. 5052

PRESELETTORE CAMBIO

(Sim.121536)

2 CAVE PER 2 ANELLI O-RING
2 GROOVES FOR 2 O-RINGS

VESPA 50 - 125 - PRIMAVERA - Et3



ART. 5053-OR

PRESELETTORE CAMBIO

(Sim.179383)

1 CAVA PER 1 ANELLO O-RING (come originale)
1 GROOVE FOR 1 O-RING (as original)

VESPA PK 50 - PK 125 - PK 50 XL

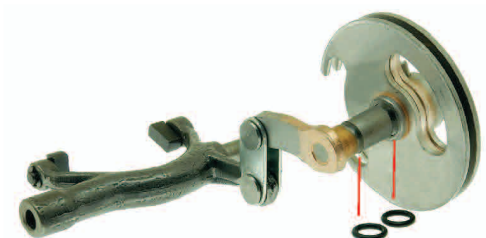

ART. 5053

PRESELETTORE CAMBIO

(Sim.179383)

2 CAVE PER 2 ANELLI O-RING
2 GROOVES FOR 2 O-RINGS

VESPA PK 50 - PK 125 - PK 50 XL

ART. 5060

MOLLA
TENUTA CROCIERA INNESTO MARCE

SELECTOR SPIDERS SPRING

VESPA 50 - 50 SPECIAL - 50 1ª SERIE -90-90SS
VESPA 125 PRIMAVERA-ET3 - PK 50/125
VESPA PK 50/125 XL - FL 50/125/HP - APE 50

(Sim. 150110)

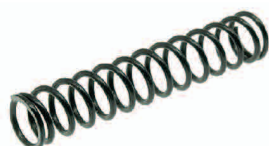

ART. 5060-KT

KIT MOLLA+SFERE
TENUTA CROCIERA INNESTO MARCE

SPRING+BALLS KIT SELECTOR SPIDERS SPRING

VESPA 50 - 50 SPECIAL - 50 1ª SERIE -90-90SS
VESPA 125 PRIMAVERA-ET3 - PK 50/125
VESPA PK 50/125 XL - FL 50/125/HP - APE 50





CROCIERE INNESTO MARCE

SELECTOR SPIDERS

angolo vivo

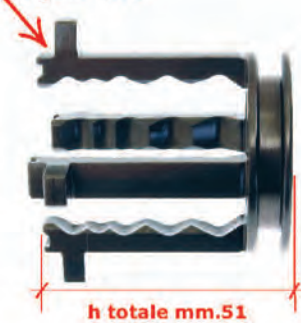

ART. **5066**

CROCIERA INNESTO MARCE **HIGH QUALITY**

4 GRIFFE - 4 VELOCITÀ / SPEED
(ALTEZZA TOTALE / TOTAL HEIGHT mm. 51)

VESPA 50 - 50 SPECIAL - 90 - 90 SS
VESPA 125 PRIMAVERA - ET3
APE 50 - 250 (produzione dall'anno 1974 AL 1978)

(Sim. 1115896)

angolo arrotondato

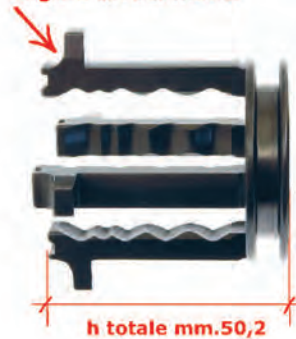

ART. **5067**

CROCIERA INNESTO MARCE **HIGH QUALITY**

4 GRIFFE - 4 VELOCITÀ / SPEED
(ALTEZZA TOTALE / TOTAL HEIGHT mm. 50,2)

VESPA 50 - 50 SPECIAL - 90 - 90 SS
VESPA 125 PRIMAVERA - ET3
VESPA PK 50/125 - PK 50/125 XL - 50/125 FL - HP
APE 50 (produzione dall'anno 1978 AL 1982)

(Sim. 134902)



ART. **5068**

CROCIERA INNESTO MARCE **HIGH QUALITY**

4 GRIFFE - 3 VELOCITÀ / SPEED
(ALTEZZA TOTALE / TOTAL HEIGHT mm. 50)

VESPA PK FL 50 (FINO AL TELAIO / TILL TO CHASSIS 73407)
VESPA HP 50 - VESPA 50 - 90 (DAL '78 AL '80)
3 MARCE / 3 SPEED

(Sim. 1653046)

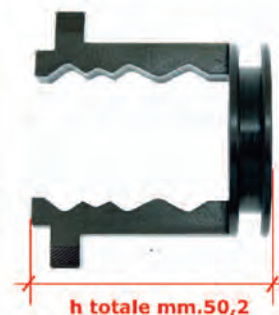

ART. **5069**

CROCIERA INNESTO MARCE **HIGH QUALITY**

2 GRIFFE - 3 VELOCITÀ / SPEED
(ALTEZZA TOTALE / TOTAL HEIGHT mm. 50,2)

VESPA 50 1ª SERIE (V5A1T)
VESPA 90 (V9A1T '63-'68)

(Sim. 078942)

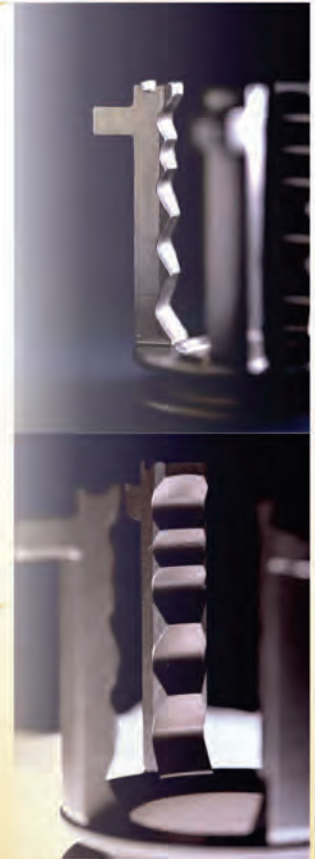

mm.7,3
come originale di una volta
as original in the past



smusso come originale di una volta
beveled as original in the past





CROCIERE CAMBIO

SELECTORS GEAR SPEED



ART. **5604**

CROCIERA CAMBIO " **HIGH QUALITY** "

(Sim. 94944)

(spessore / thickness mm. 5)

VESPA 125 - 150 fino al 1973
APE MP 1ª SERIE



ART. **5604-R**

CROCIERA CAMBIO " **HIGH QUALITY** "
RINFORZATA/REINFORCED

(Sim. 94944)

(spessore / thickness mm. 5,5)

VESPA 125 - 150 fino al 1973
APE MP 1ª SERIE



ART. **5605**

CROCIERA CAMBIO " **HIGH QUALITY** "

(Sim.130939)

(spessore / thickness mm. 5,5)

VESPA PX PE - VESPA PX PE ARCOBALENO fino al 1989
VESPA 125 - 150 dal 1974



ART. **5605-T5**

CROCIERA CAMBIO " **HIGH QUALITY** "

(Sim. 223225)

(spessore / thickness mm. 5)

VESPA PX PE ARCOBALENO DAL 1989 - 125 T5
VESPA COSA

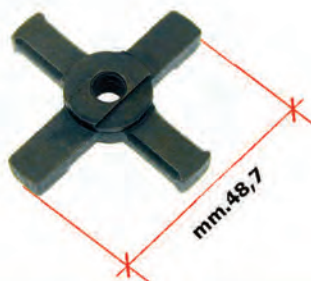

ART. **5606-V30**

CROCIERA CAMBIO " **HIGH QUALITY** "

(Sim. 14180)

(spessore / thickness mm. 6)

VESPA 125
(DAL 1951 AL 1953) DAL V30T AL V33T - VU1T



STELI COMANDO CAMBIO

SELECTOR SPINDLES



ART. **6522**

STELO COMANDO CAMBIO CROCIERA

(Sim.1309406)

VESPA PX PE - PX PE sr. ARCOBALENO al '89
VESPA SPRINT-RALLY



ART. **6523**

STELO COMANDO CAMBIO CROCIERA

(Sim.2232325)

VESPA PX PE ARCOBALENO DAL '89 - 125 T5
VESPA COSA - LML STAR 2T/4T 125/150/200 cc.



LEggermente SCARICATO PER
ACCOSTO AD OK DELLA CROCIERA

ART. **6523-HQ**

STELO COMANDO CROCIERA CAMBIO

(Sim.2232325)

HIGH QUALITY

(LEggermente SCARICATO PER ACCOSTO AD OK DELLA CROCIERA)

SELECTOR SPINDLE **HIGH QUALITY"**

(SLIGHTLY DOWNLOADED FOR THE SELECTOR SPIDER APPROACH OK)

VESPA PX PE ARCOBALENO DAL '89 - - 125 T5
VESPA COSA - LML STAR 2T/4T 125/150/200 cc.

ALBERI CAMBIO

DRIVE SHAFTS



ART. **6507**

ALBERO CAMBIO

(Sim.1578005)

VESPA PX PE ARCOBALENO ('81-'97)
VESPA SPRINT - RALLY



ART. **6503**

ALBERO CAMBIO

(Sim. 235908)

VESPA PX PE ARCOBALENO DAL 1989->
VESPA 125 T5 - COSA



ART. **5812**

ASTUCCIO A RULLI (28 x 35 x 13)
PER ALBERO CAMBIO / DRIVE SHAFT ROLLER CAGE

(Sim. 106956)

VESPA PX PE tutti modelli / all models
VESPA 125 T5 - VESPA COSA

PRESELETTORI CAMBIO

SELECTOR GEAR SPEED BOX



ART. **5056**

PRESELETTORE CAMBIO

VESPA P125X - P150X - P200E
VESPA PX SERIE ARCOBALENO ('81-'97)

(Sim.610369M-1388806)



ART. **5056-E**

PRESELETTORE CAMBIO VERSIONE **ECO-PLUS**
COMPLETO DI REGISTRI

VESPA P125X - P150X - P200E
VESPA PX SERIE ARCOBALENO ('81-'97)

(Sim.610369M-1388806)



ART. **5058**

PRESELETTORE CAMBIO CON SEGNALE DI FOLLE
SELECTOR GEAR SPEED BOX WITH NEUTRAL SIGN

VESPA PX PE ARCOBALENO - VESPA COSA

(Sim.199803)



ART. **6526**

COPERCHIO ZINCATO PER PRESELETTORE CAMBIO
ZINCED COVER FOR SECLECTOR GEAR BOX

VESPA PX PE 125/150 - VESPA COSA

(Sim. 138865)



ART. **5054**

PRESELETTORE CAMBIO
(3ª VELOCITA' / SPEED)

VESPA 125 - 150 (dal '58 al '63)

(Sim. 47169)



ART. **5055**

PRESELETTORE CAMBIO
(4ª VELOCITA' / SPEED)

VESPA 150 SUPER SPRINT

(Sim. 92167)



INGRANAGGI CAMBIO

GEARS SPEED

VESPA P125X/P150X - PX 125E/PX 150E - SPRINT 150 (VLB1T) - GT 125 (VNL2T)



ART. **6581**

INGRANAGGIO **z 57** - 1ª VELOCITA' (Sim.152796)

DENTI PASSO FINE - SPESSORE DENTI mm.10

GEAR, 1ª SPEED
FINE PITCH GOGS - COGS THICKNESS mm.10



ART. **6582**

INGRANAGGIO **z 54** - 2ª VELOCITA'
DENTI PASSO FINE

GEAR, 2ª SPEED - FINE PITCH GOGS
(Sim. 152797)



ART. **6583**

INGRANAGGIO **z 48** - 3ª VELOCITA'
DENTI PASSO FINE

GEAR, 3ª SPEED - FINE PITCH GOGS
(Sim. 152798)



ART. **6584**

INGRANAGGIO **z 44** - 4ª VELOCITA'
DENTI PASSO FINE

GEAR, 4ª SPEED - FINE PITCH GOGS
(Sim. 152799)

VESPA P200E (vsx1T) - RALLY 180 (vsd1T) - RALLY 200 (vse1T)



ART. **6571**

INGRANAGGIO **z 57** - 1ª VELOCITA' (Sim. 152804)

DENTI PASSO FINE - SPESSORE DENTI mm.11

GEAR, 1ª SPEED
FINE PITCH GOGS - COGS THICKNESS mm.11



ART. **6572**

INGRANAGGIO **z 42** - 2ª VELOCITA'
DENTI PASSO GROSSO

GEAR, 2ª SPEED - BIG PITCH GOGS
(Sim. 152805)



ART. **6573**

INGRANAGGIO **z 38** - 3ª VELOCITA'
DENTI PASSO GROSSO

GEAR, 3ª SPEED - BIG PITCH GOGS
(Sim. 152806)



ART. **6574**

INGRANAGGIO **z 35** - 4ª VELOCITA'
DENTI PASSO GROSSO

GEAR, 4ª SPEED - BIG PITCH GOGS
(Sim. 152807)

SERIE DISCHI FRIZIONE

CLUTCH DISCS SET

VESPA PX 125/150 - VESPA SPRINT



ART. **5586**

SERIE DISCHI FRIZIONE NORMALE
(N. 3 DISCHI SUGHERO)

CLUTCH DISCS SET (N.3 CORKS DISCS)

VESPA PX 125-150 - SPRINT

ADATTABILE/SUITABLE :
VESPA 125 DAL 1960 (DAL VNB2 AL VNB6-VBB2)-GL 150

(Sim. Nr. 2 pz. x 94743 + Nr. 1 pz. x 94780)



ART. **5586-CN**

SERIE DISCHI FRIZIONE **COMPLETA NORMALE**
(N.3 DISCHI SUGHERO+2 DISCHI ACCIAIO+6 MOLLE)

CLUTCH DISCS COMPLETE NORMAL SET
(N.3 CORK DISCS+2 STEEL DISCS+6 SPRINGS)

VESPA PX 125- 150 - SPRINT

ADATTABILE/SUITABLE :
VESPA 125 DAL 1960 (DAL VNB2 AL VNB6-VBB2)-GL 150

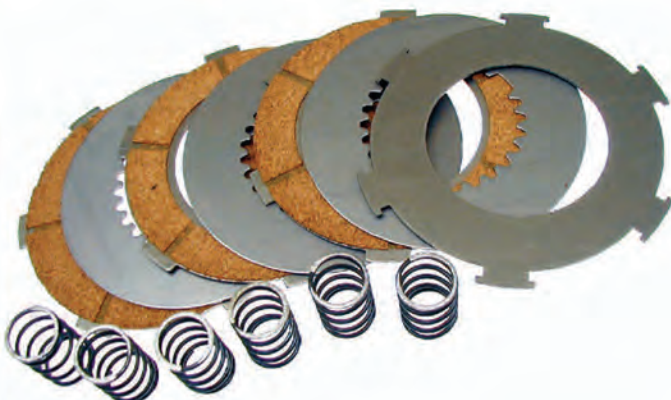

ART. **5586-C**

SERIE DISCHI FRIZIONE **MODIFICA**

(N. 4 DISCHI SUGHERO + N. 3 DISCHI ACCIAIO
+ 6 MOLLE RINFORZATE)

CLUTCH DISC COMPLETE SET
(N. 4 CORK DISCS + 3 STEEL DISCS + 6 REINFORCED SPRINGS)

VESPA PX 125-150 - SPRINT



SERIE DISCHI FRIZIONE

CLUTCH DISCS SET

VESPA PE 200 - 125 T5 - RALLY 180/200 - VESPA COSA 1-2

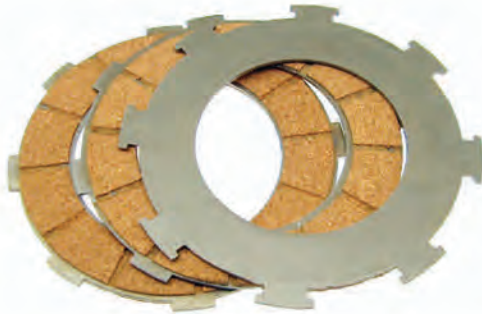

ART. **5585**

SERIE DISCHI FRIZIONE NORMALE
(N. 3 DISCHI SUGHERO)

CLUTCH DISCS SET (N.3 CORK DISCS)

VESPA PE 200 - 125 T5 - RALLY 180/200 - VESPA COSA 1-2

(Sim. Nr. 2 pz. x 59388 + Nr. 1 pz. x 50721)



ART. **5585-CN**

SERIE DISCHI FRIZIONE **COMPLETA NORMALE**
(N.3 DISCHI SUGHERO+2 ACCIAIO+7 MOLLE)

CLUTCH DISCS COMPLETE NORMAL SET
(N.3 CORK DISCS+2 STEEL+7 SPRINGS)

VESPA PE 200 - 125 T5 - RALLY 180/200 - VESPA COSA 1-2



ART. **5585-C**

SERIE DISCHI FRIZIONE **MODIFICA**

(N. 4 DISCHI SUGHERO + N. 3 DISCHI ACCIAIO
+ 7 MOLLE RINFORZATE)

CLUTCH DISC COMPLETE SET
(N. 4 CORK DISCS + 3 STEEL DISCS + 7 REINFORCED SPRINGS)

VESPA PE 200 - 125 T5 - RALLY 180/200 - VESPA COSA 1-2

RICAMBI FRIZIONE

CLUTCH SPARE PARTS



ART. **5600**

CAMPANA FRIZIONE

CLUTCH DRUM

VESPA PX 125/150-SPRINT-SUPER

(Sim.59369)



ART. **C00126**

ANELLO ELASTICO PER
CHIUSURA DISCO FRIZIONE

OUTER DRIVING DISC CIRCLIP

VESPA PX 125/150-SPRINT-SUPER

(Sim.032005)



ART. **C00125-N**

DISCO CONDOTTO IN FERRO
Ø mm. 97

SPESSORE NORMALE mm.1,40
(per CIF ART. 5586/5586-CN)

CLUTCH IRON DISC, Ø mm. 97
NORMAL THICKNESS mm.1,40

VESPA PX 125/150-SPRINT

(Sim. 094425)



ART. **10309**

CAMPANA FRIZIONE

CLUTCH DRUM

VESPA PE 200-125 T5-RALLY 200

(Sim.245829)



ART. **C00129**

ANELLO ELASTICO PER
CHIUSURA DISCO FRIZIONE

OUTER DRIVING DISC CIRCLIP

VESPA PE 200-125 T5-RALLY 200

(Sim.038477)



ART. **C00128**

DISCO CONDOTTO IN FERRO
Ø mm. 108

SPESSORE NORMALE mm.1,30
(per CIF ART. 5585/5585-CN)

CLUTCH IRON DISC, Ø mm. 108
NORMAL THICKNESS mm.1,30

VESPA PE 200-125 T5
RALLY 180/200 - COSA 1-2

(Sim. 093745)



ART. **5648**

MOLLA FRIZIONE

CLUTCH SPRING

VESPA PX PE-RALLY-SPRINT-SUPER

(Sim.22821)



ART. **5601**

SCODELLINO PER MOLLE FRIZIONE

CUP FOR CLUTCH SPRINGS

VESPA PX PE-RALLY-SPRINT-SUPER

(Sim.21868)



SERIE PIATTELLI FRIZIONE

CLUTCH PRESSURE PLATE SET

VESPA PX 125/150 - SPRINT - SUPER



ART. **5591**

SERIE PIATTELLO COMPLETA
(PIATTELLO + RALLINO + MOLLA)

CLUTCH PRESSURE PLATE SET

VESPA PX 125/150 - SPRINT - SUPER

VESPA PE 200 - 125 T5 - RALLY 200



ART. **5592**

SERIE PIATTELLO COMPLETA
(PIATTELLO + RALLINO + MOLLA)

CLUTCH PRESSURE PLATE SET

VESPA PE 200 - 125 T5 - RALLY 200



ART. **5592-KT**

KIT SERIE PIATTELLO COMPLETO

(PIATTELLO + RALLINO + MOLLA + LEVETTA INTERNA FRIZIONE)

CLUTCH PRESSURE PLATE COMPLETE SET

VESPA PE 200 - 125 T5 - RALLY 200

ART. **5596**

RALLINO SFUSO

PLUNGER

VESPA PX 125/150
VESPA SPRINT -SUPER
VESPA PE 200 - 125 T5
VESPA - RALLY 200

(Sim. 89858)



ART. **5588**

MOLLA RITEGNO

SPRING CLIP

VESPA 50 - 90 - 125 PRIMAVERA ET3
VESPA PK - PK XL - RUSH - N
VESPA PX 125/150 - SPRINT -SUPER
PE 200 - 125 T5 - RALLY 200

(Sim. 14457)



ART. **C00135**

LEVETTA
INTERNA FRIZIONE

CLUTCH INSIDE LEVER

VESPA PE 200 - VESPA 125 T5
VESPA RALLY 200

(Sim. 83806)



INGRANAGGI FRIZIONE

CLUTCH GEAR



ART. **6514** **VESPA P125X** (VNX1T->146313)..... (Sim. 113069)
VESPA P150X (VLX1T->264564)
VESPA P150S (VBX1T)
VESPA 125 TS - GTR CON MISCELATORE
VESPA 150 SPRINT-SUPER CON MISCELATORE
DENTI ELICOIDALI / *HELICOIDAL COGS* **z 22**
DENTI DIRITTI / *STRAIGHT COGS* z 26

ART. **6540** **VESPA P125X** (VNX1T DAL 146314) (Sim.174733)
VESPA P150X (VLX1T DAL 264565)
VESPA PX 150E ARCOBALENO/ELESTART
DENTI ELICOIDALI / *HELICOIDAL COGS* **z 21**
DENTI DIRITTI / *STRAIGHT COGS* z 26

ART. **6542** **VESPA P80X - PX80E - PX125E** (Sim.1780005)
DENTI ELICOIDALI / *HELICOIDAL COGS* **z 20**
DENTI DIRITTI / *STRAIGHT COGS* z 26

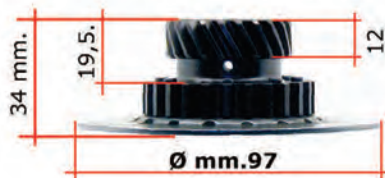

ART. **6513** **VESPA SPRINT 150** (VLB1T) (Sim.1501035)
VESPA SPRINT VELOCE (VLB1T)
VESPA SUPER 150(VBC1T)
VESPA GT 125 (VNL2T) - **GTR 125** (VNL2T)
DENTI ELICOIDALI / *HELICOIDAL COGS* **z 22**
DENTI DIRITTI / *STRAIGHT COGS* z 26

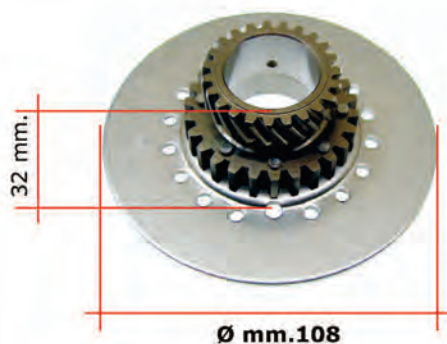

ART. **6515** **VESPA PE 200 - RALLY 180-200** (Sim. 130823)
DENTI ELICOIDALI / *HELICOIDAL COGS* **z 23**
DENTI DIRITTI / *STRAIGHT COGS* z 26

ART. **6543** **VESPA COSA 1-2 200 cc.** (Sim. 237272)
DENTI ELICOIDALI / *HELICOIDAL COGS* **z 21**
DENTI DIRITTI / *STRAIGHT COGS* z 26

ART. **6544** **VESPA 125 T5** (Sim. 241346)
DENTI ELICOIDALI / *HELICOIDAL COGS* **z 20**
DENTI DIRITTI / *STRAIGHT COGS* z 26





BOCCOLI FRIZIONE

CLUTCH BACKPLATES

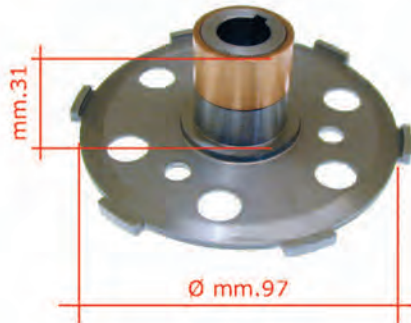

ART. 5603

BOCCOLO FRIZIONE
COMPLETO DI BRONZINA "HQ" AUTOLUBRIFICANTE

(Sim.159905)

COMPLETE WITH BUSH "HQ" SELF-LUBRICATING

VESPA P125X - P150X
VESPA PX 125 - PX 150E
VESPA P80X - PX80E - PX125E

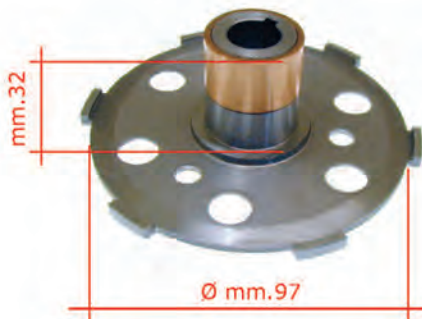

ART. 5603-A

BOCCOLO FRIZIONE
COMPLETO DI BRONZINA "HQ" AUTOLUBRIFICANTE

(Sim.159849)

COMPLETE WITH BUSH "HQ" SELF-LUBRICATING

VESPA SPRINT 150 (VLB1T)
VESPA SPRINT VELOCE (VLB1T)
VESPA SUPER 150 (VBC1T)
VESPA GT 125 (VNL2T)
VESPA GTR 125 (VNL2T)

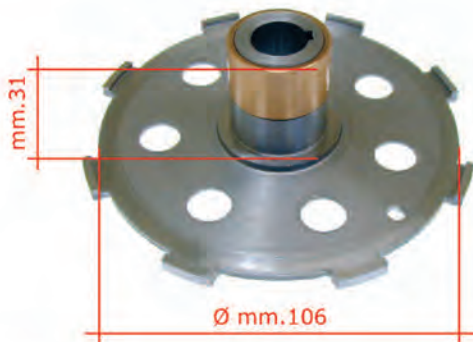

ART. 5603-B

BOCCOLO FRIZIONE
COMPLETO DI BRONZINA "HQ" AUTOLUBRIFICANTE

(Sim.159853)

COMPLETE WITH BUSH "HQ" SELF-LUBRICATING

VESPA PE 200
VESPA RALLY 180/200
VESPA 125 T5
VESPA COSA 1-2 200



ART. 5843

BRONZINA "HQ" AUTOLUBRIFICANTE
PER BOCCOLO FRIZIONE

(Sim.59365)

BUSH "HQ" SELF-LUBRICATING FOR CLUTCH BACKPLATE

VESPA TUTTI TIPI / ALL MODELS



ART. C00130

RONDELLA IN OTTONE
DI SPESSORE TRA BOCCOLO E INGRANAGGIO FRIZIONE

BRASS WASHER BETWEEN CLUTCH BACKPLATE AND GEAR

HIGH QUALITY

PERNI PER INGRANAGGIO MULTIPLIO CLUSTER GEAR PINS



ART. **6530**

PERNO INGRANAGGIO MULTIPLIO
VESPA 125 ('63-'65)

(Sim.094417)



ART. **6531**

PERNO INGRANAGGIO MULTIPLIO
VESPA SUPER - GT 125 (30743>34500)
P150S (>169035)

(Sim.110512)



ART. **6532**

PERNO INGRANAGGIO MULTIPLIO
VESPA P125X (>146316) - TS 125 - SPRINT VELOCE
VESPA GTR 125 ('69-'78)

(Sim.094419)



ART. **6533**

PERNO INGRANAGGIO MULTIPLIO
VESPA P200E - RALLY 180

(Sim.111715)



ART. **6534**

PERNO INGRANAGGIO MULTIPLIO
VESPA P125X (146314>) - PX 125E - PX 125 E ARCOBALENO
VESPA P150S (169036>) - P200E (109056>) - P150X (264565>)
VESPA T5 - VESPA COSA

(Sim.174515)



ART. **6509**

INGRANAGGIO QUADRUPLIO
CLUSTER GEAR

z12-13-17-21

SEDE CUSCINETTO Ø mm. 42

VESPA RALLY 180/200
P125X - P150X 2s - P150S 2s
VESPA PX125E-PX 200E-P200E
VESPA 125 T5 - COSA

(Sim.137334-2362224)



ART. **6508**

INGRANAGGIO QUADRUPLIO
CLUSTER GEAR

z12-16-20-25

SEDE CUSCINETTO Ø mm. 40

VESPA GT 125 - GTR 125 ('69-'78)
VESPA TS
VESPA SPRINT-SPRINT VELOCE
VESPA P125X - P150X

(Sim.0979234)



ART. **6508-A**

INGRANAGGIO QUADRUPLIO
CLUSTER GEAR

z13-17-22-27

SEDE CUSCINETTO Ø mm. 37

VESPA 150 ('62-'65)

(Sim.2/58677)

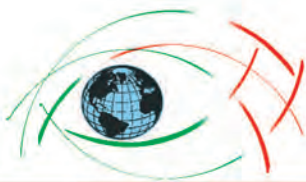

CORONE PARASTRAPPI

CUSH GEAR

ART. 6565

VESPA PX 200E (Vsx1T) - **RALLY 180/200** (VSD1 - VSE1) (Sim.1315874-1127205)

DENTI ELICOIDALI / HELICOIDAL COGS **z 65**



ART. 6567

VESPA P125X (VNX1T->146313) - **P150X** (VLX1T->264564) (Sim.077351)

VESPA P150S (VBX1T->169035) - **RALLY 180** (VSD1)

VESPA SPRINT 150 (VLB1T) - **SPRINT VELOCE** (VLB1T)

VESPA SUPER 150 (VBC1T) - **GT 125** (VNL2T) - **GTR 125** (VNL2T)

VESPA 125 TS - GTR CON MISCELATORE / WITH MIX

VESPA 150 SPRINT-SUPER CON MISCELATORE / WITH MIX

DENTI ELICOIDALI / HELICOIDAL COGS **z 67**

ART. 6568

VESPA 125 T5 (VNX5) - **P80X - PX80E - PX125E** (VNX2) (Sim.174825.5)

VESPA P125X (VNX1T dal 146314) - **P150X** (VLX1T dal 264565)

VESPA COSA 1-2 200 cc.

DENTI ELICOIDALI / HELICOIDAL COGS **z 68**

SERIE PARASTRAPPI COMPLETE

COMPLETE CUSH GEAR SET



ART. 5076

SERIE PARASTRAPPI COMPLETA
CON DOPPIA SERIE DI MOLLE
CON RIBATTINI A GIUSTA MISURA

COMPLETE CUSH GEAR SET
WITH DOUBLE SPRINGS SET
RIGHT SIZE RIVETS

VESPA PX PE - 125 T5 - RALLY - GS 160 - SPRINT



ART. 5077

SERIE PARASTRAPPI COMPLETA (Sim.610055M)

COMPLETE CUSH GEAR SET

VESPA 125 (VM1/2T '53-'54)

VESPA 125 (VN1/2T '54-'57)

VESPA 150 (VL1/2/3T '55-'56)

GRUPPI FRIZIONE COMPLETI

CLUTCHES ASSY

VESPA P80X - PX80E - PX 125E

z 20



ART. **5997**

GRUPPO FRIZIONE COMPLETO MONTATO

NORMALE CON 3 DISCHI SUGHERO + 2 DISCHI ACCIAIO

MONTA INGRANAGGIO FRIZIONE:

DENTI ELICOIDALI **z 20** - DENTI DIRITTI z 26 - h 32 - DISCO Ø mm. 97

NORMAL WITH: 3 CORK DISCS + 2 STEEL DISCS

WITH CLUTCH GEAR: HELICOIDAL COGS **z 20** - STRAIGHT COGS z 26 - h 32 - DISC Ø mm. 97



VESPA P125X - P150X 1ª SERIE - P150S

z 22



ART. **5977**

GRUPPO FRIZIONE COMPLETO MONTATO (Sim.113070)

NORMALE CON 3 DISCHI SUGHERO + 2 DISCHI ACCIAIO

MONTA INGRANAGGIO FRIZIONE:

DENTI ELICOIDALI **z 22** - DENTI DIRITTI z 26 - h 32 - DISCO Ø mm. 97

NORMAL WITH 3 CORK DISCS + 2 STEEL DISCS

WITH CLUTCH GEAR: HELICOIDAL COGS **z 22** - STRAIGHT COGS z 26 - h 32 - DISC Ø mm. 97

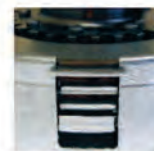

ART. **5978**

GRUPPO FRIZIONE COMPLETO MONTATO

MODIFICA CON 4 DISCHI SUGHERO+3 DISCHI ACCIAIO+MOLLE

MONTA INGRANAGGIO FRIZIONE:

DENTI ELICOIDALI **z 22** - DENTI DIRITTI z 26 - h 32 - DISCO Ø mm. 97

MODIFICATION WITH 4 CORK DISCS + 3 STEEL DISCS+SPRINGS

WITH CLUTCH GEAR: HELICOIDAL COGS **z 22** - STRAIGHT COGS z 26 - h 32 - DISC Ø mm. 97



VESPA P125X - P150X 2ª SERIE - PX 150E ARCOBALENO/ELESTART

z 21

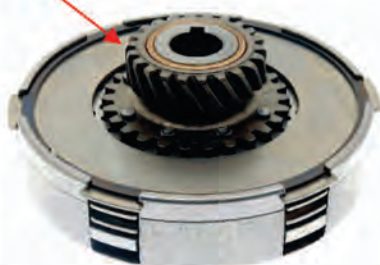

ART. **5977-D21**

GRUPPO FRIZIONE COMPLETO MONTATO

NORMALE CON 3 DISCHI SUGHERO + 2 DISCHI ACCIAIO

MONTA INGRANAGGIO FRIZIONE:

DENTI ELICOIDALI **z 21** - DENTI DIRITTI z 26 - h 32 - DISCO Ø mm. 97

NORMAL VERSION WITH 3 CORK DISCS + 2 STEEL DISCS

WITH CLUTCH GEAR: HELICOIDAL COGS **z 21** - STRAIGHT COGS z 26 - h 32 - DISC Ø mm. 97



ART. **5978-D21**

GRUPPO FRIZIONE COMPLETO MONTATO

MODIFICA CON 4 DISCHI SUGHERO+3 DISCHI ACCIAIO+MOLLE

MONTA INGRANAGGIO FRIZIONE:

DENTI ELICOIDALI **z 21** - DENTI DIRITTI z 26 - h 32 - DISCO Ø mm. 97

MODIFICATION WITH 4 CORK DISCS+3 STEEL DISCS+SPRINGS

WITH CLUTCH GEAR: HELICOIDAL COGS **z 21** - STRAIGHT COGS z 26 - h 32 - DISC Ø mm. 97





GRUPPI FRIZIONE COMPLETI

CLUTCHES ASSY

VESPA SPRINT 150 - SPRINT VELOCE - SUPER 150 - 125 GT-GTR

z 22



ART. **5976**

GRUPPO FRIZIONE COMPETO MONTATO (SIM. 98028)

NORMALE CON 3 DISCHI SUGHERO + 2 DISCHI ACCIAIO

MONTA INGRANAGGIO FRIZIONE :

DENTI ELICOIDALI **z 22** - DENTI DIRITTI Z 26 - **h 34** - DISCO Ø mm. 97

NORMAL WITH N.3 CORK DISCS+2 STEEL DISCS

WITH CLUTCH GEAR:

HELICOIDAL COGS **z 22** - STRAIGHT COGS z 26 - **h 34** - DISC Ø mm. 97

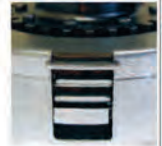

VESPA PE 200 - RALLY 180/200

z 23



ART. **5979**

GRUPPO FRIZIONE COMPLETO MONTATO (SIM. 4335486-2458305-131223)

NORMALE CON 3 DISCHI SUGHERO + 2 DISCHI IN ACCIAIO

MONTA INGRANAGGIO FRIZIONE:

DENTI ELICOIDALI **z 23** - DENTI DIRITTI z 26 - h 32 - DISCO Ø mm. 108

NORMAL VERSION WITH N.3 CORK DISCS + 2 STEEL DISCS

WITH CLUTCH GEAR:

HELICOIDAL COGS **z 23** - STRAIGHT COGS z 26 - h 32 - DISC Ø mm. 108



ART. **5979-R**

GRUPPO FRIZIONE COMPLETO MONTATO

MODIFICA CON 4 DISCHI SUGHERO+3 DISCHI ACCIAIO+MOLLE

MONTA INGRANAGGIO FRIZIONE:

DENTI ELICOIDALI **z 23** - DENTI DIRITTI z 26 - h 32 - DISCO Ø mm. 108

MODIFICATION WITH N.4 CORK DISCS+3 STEEL DISCS+SPRINGS

WITH CLUTCH GEAR:

HELICOIDAL COGS **z 23** - STRAIGHT COGS z 26 - h 32 - DISC Ø mm. 108



VESPA 125 T5

z 20



ART. **5999**

GRUPPO FRIZIONE COMPETO MONTATO

NORMALE CON 3 DISCHI SUGHERO + 2 DISCHI ACCIAIO

MONTA INGRANAGGIO FRIZIONE :

DENTI ELICOIDALI **z 20** - DENTI DIRITTI z 26 - h 34 - DISCO Ø mm. 108

NORMAL WITH 3 CORK DISCS+2 STEEL DISCS

WITH CLUTCH GEAR:

HELICOIDAL COGS **z 20** - STRAIGHT COGS z 26 - h 34 - DISC Ø mm. 108



GRUPPI FRIZIONE COMPLETI

CLUTCHES ASSY

VESPA COSA 1-2 200

LML STAR 2T 150 - LML STAR (DELUXE) 125/150 - LML 125/150 4T

z 21

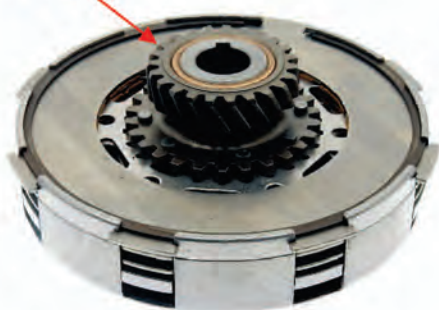

ART. **5998**

GRUPPO FRIZIONE COMPETO MONTATO

NORMALE CON 3 DISCHI SUGHERO + 2 DISCHI ACCIAIO
MONTA INGRANAGGIO FRIZIONE :
DENTI ELICOIDALI **z 21**- DENTI DIRITTI z 26 - h 34 - DISCO Ø mm. 108



NORMAL WITH 3 CORK DISCS+2 STEEL DISCS
WITH CLUTCH GEAR:
HELICOIDAL COGS **z 21** - STRAIGHT COGS z 26 - h 34 - DISC Ø mm. 108



VESPA PX FRENO A DISCO DAL / SINCE 1995

ART. **5972**

GRUPPO FRIZIONE COMPLETO MONTATO

(Sim. 2886505)

VESPA PX 125 FRENO A DISCO DAL 1995

MONTA INGRANAGGIO FRIZIONE DENTI ELICOIDALI **z 20**
WITH CLUTCH GEAR HELICOIDAL COGS **z 20**



ART. **5974**

GRUPPO FRIZIONE COMPLETO MONTATO

(Sim. 2867635)

VESPA PX 150 FRENO A DISCO DAL 1995

MONTA INGRANAGGIO FRIZIONE DENTI ELICOIDALI **z 21**
WITH CLUTCH GEAR HELICOIDAL COGS **z 21**

ART. **5975**

GRUPPO FRIZIONE COMPLETO MONTATO

(Sim. 433548)

VESPA PX 200 FRENO A DISCO DAL 1995

MONTA INGRANAGGIO FRIZIONE DENTI ELICOIDALI **z 23**
WITH CLUTCH GEAR HELICOIDAL COGS **z 23**



SR. DISCHI - BOCCOLO FRIZIONE

CLUTCH DISCS SET AND BACKPLATE



ART. 5586-FD

SERIE DISCHI FRIZIONE NORMALE
(NR. 4 DISCHI IN SUGHERO)

CLUTCH DISCS SET (N. 4 CORK DISCS)

VESPA PX 125 - 150 - 200 FRENO A DISCO DAL 1995



ART. 5603-FD

BOCCOLO FRIZIONE CON BRONZINA AUTOLUBRIFICANTE

CLUTCH BACKPLATE WITH SELF-LUBRICATING BUSH

VESPA PX 125 - 150 - 200 FRENO A DISCO DAL 1995

(Sim. 285079)

INGRANAGGI FRIZIONE

CLUTCH GEARS



ART. 6551

INGRANAGGIO FRIZIONE **z 20**

VESPA PX 125 (VNX2T 1998-2001)

VESPA PX 30 ANNI 125

(Sim. 2868994)

ART. 6553

INGRANAGGIO FRIZIONE **z 21**

VESPA PX 150 (VLX1T 1998-2001)

(Sim. 2867624)

ART. 6555

INGRANAGGIO FRIZIONE **z 22**

VESPA PX 150 E (LUSSO) (1998-2001)

VESPA COSA 2

ART. 6557

INGRANAGGIO FRIZIONE **z 23**

VESPA PX 200 (VSX1T 1998-2001)

(Sim. 4335474)

SERIE DISCHI FRIZIONE

CLUTCH DISCS SET

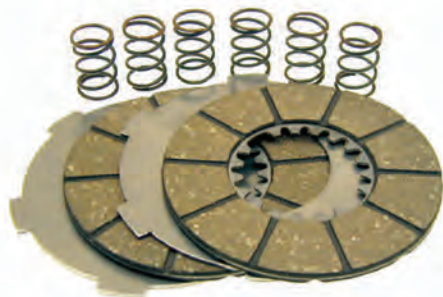

Ø ESTERNO DISCO / EXTERNAL DISC mm.84

ART. 4016

SERIE DISCHI FRIZIONE COMPLETA
(N. 2 DISCHI RIVESTITI SPESSORE mm.4
+ 2 DISCHI ACCIAIO SPESSORE mm.1,5
+ 6 MOLLE)

CLUTCH DISCS COMPLETE SET
(N.2 CORK DISCS, THICKNESS mm.4
+ 2 STEEL DISCS, THICKNESS mm.1,5
+ 6 SPRINGS)

VESPA 98 - VESPA 125

(DAL V1T AL V15T 1948-1950)
(DAL V30T AL V33T 1951-1952)



Ø ESTERNO DISCO / EXTERNAL DISC mm.84

ART. 4017

SERIE DISCHI FRIZIONE COMPLETA
(N. 3 DISCHI RIVESTITI SPESSORE mm.3
+ 3 DISCHI ACCIAIO SPESSORE mm.1
+ 6 MOLLE)

CLUTCH DISCS COMPLETE SET
(N.3 CORK DISCS, THICKNESS mm.3
+ 3 STEEL DISCS, THICKNESS mm.1
+ 6 SPRINGS)

VESPA 125

(DAL 1953 AL 1954) (VM1/2T - VU1T)

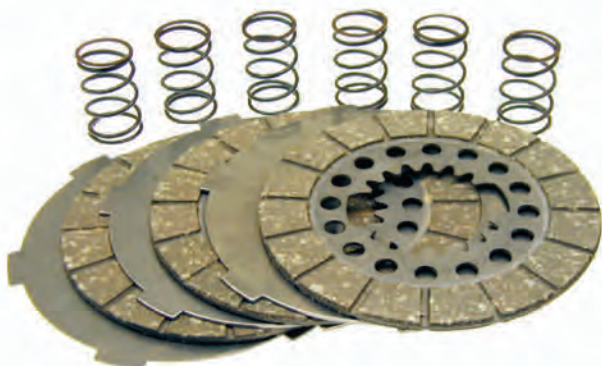

Ø ESTERNO DISCO / EXTERNAL DISC mm.96

ART. 4018

SERIE DISCHI FRIZIONE COMPLETA
(N. 3 DISCHI RIVESTITI + 3 DISCHI ACCIAIO
+ 6 MOLLE)

CLUTCH DISCS COMPLETE SET
(N.3 CORK DISCS + 3 STEEL DISCS + 6 SPRINGS)

VESPA 125 (VN1/2T)

VESPA 150 (VL1/2/3T DAL 1955 AL 1957)



SERIE DISCHI FRIZIONE

CLUTCH DISCS SET

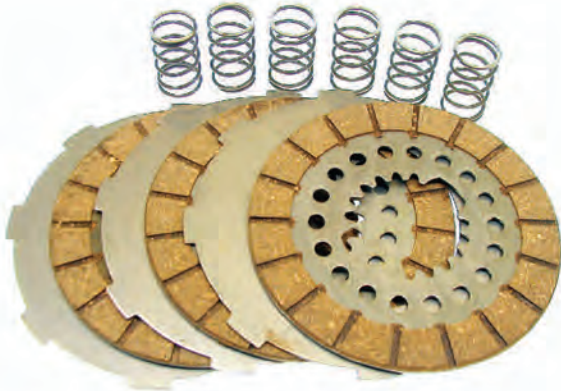

Ø ESTERNO DISCO / EXTERNAL DISC mm.105



FORO STRETTO
TIGHT HOLE

ART. **4019**

SERIE DISCHI FRIZIONE COMPLETA

(N. 3 DISCHI RIVESTITI
+ 3 DISCHI ACCIAIO
+ N. 6 MOLLE)

CLUTCH DISCS COMPLETE SET
(N.3 CORK DISCS + 3 STEEL DISCS + 6 SPRINGS)

VESPA GS 150 (VS1-VS2)



Ø ESTERNO DISCO / EXTERNAL DISC mm.105



FORO LARGO
LARGE HOLE

ART. **4020**

SERIE DISCHI FRIZIONE COMPLETA

(N. 3 DISCHI RIVESTITI
+ 3 DISCHI ACCIAIO
+ 6 MOLLE)

CLUTCH DISCS COMPLETE SET
(N.3 CORK DISCS + 3 STEEL DISCS + 6 SPRINGS)

VESPA GS 150
(VS2-VS3-VS4) (VS5 DAL TELAIO 47351 AL 63168)

CUSCINETTI

BEARINGS



ART. 5827-A

CUSCINETTO FAG A SFERE (15x42x13)

(Sim. 83018R-253934-112793)

PER ALBERO PRIMARIO / FOR PRIMARY SHAFT

VESPA T5 125 ('85-'89) - PX 125-150-200 ('98-'01)
 VESPA PXE ARCOBALENO 125-150-200 ('81-'97) - GTR 125 - SUPER 150
 VESPA SPRINT 150 - RALLY - COSA CL/CLX 125-150-200 - COSA 2 125-150-200

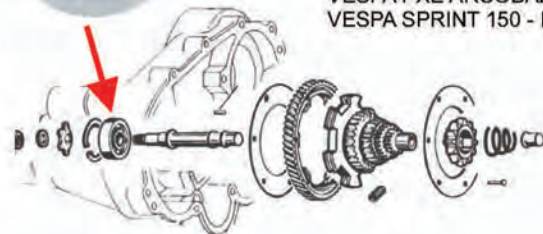

ART. 5821

CUSCINETTO SKF 12x40x12 (613963/C3)

(Sim.097718)

PER ALBERINO INGRANAGGIO QUADRUPLO
 FOR GEAR CLUSTER SHAFT

VESPA TS 125 (VLN3 '75-'78)
 GT 125 (VNL2T 30001->30742('66-'73)-(VNL2T 34501->)-VNL2T 100001->(69-78)
 SPRINT 150 (VLB1T 038601->)-SPRINT VELOCE 150 (VLB1T 0150001-> ('69-'79)
 P125X (VNX1T ->146313) - P150X (VLX1T ->264564)-SUPER 150 (VBC1T 286819RC)

ART. 5821-A

CUSCINETTO (12x40x12)

(Sim.097718)

PER ALBERINO INGRANAGGIO QUADRUPLO
 FOR GEAR CLUSTER SHAFT

VESPA TS 125 (VLN3 '75-'78)
 GT 125 (VNL2T 30001->30742('66-'73)-(VNL2T 34501->)-VNL2T 100001->(69-78)
 SPRINT 150 (VLB1T 038601->)-SPRINT VELOCE 150 (VLB1T 0150001-> ('69-'79)
 P125X (VNX1T ->146313) - P150X (VLX1T ->264564)- SUPER 150 (VBC1T 286819RC)



ART. 16301-C3

CUSCINETTO SKF (12x37x12) (6301C3)

(Sim. 090024)

PER INGRANAGGIO MULTIPLO CAMBIO
 BEARING FOR GEARBOX MULTIPLE GEAR

VESPA 125-150 VECCHI MODELLI-/ OLD MODELS



ART. 16200-C3

CUSCINETTO SKF (10x30x9) (6200-C3)

(Sim. 007035)

INGRANAGGIO MULTIPLO CAMBIO
 BEARING FOR GEARBOX MULTIPLE GEAR

VESPA 50-90-PRIMAVERA - ET3 - PK 50-125-PK XL-RUSH-N - FL-FL2 - HP
 APE P50 - FL-FL2-FL3-RST MIX



CUSCINETTI

BEARINGS



ART. 5831-HQ

KIT CUSCINETTO HIGH QUALITY made in Italy
ALBERO RUOTA LATO CAMBIO

BEARING KIT FOR WHEEL HIGH QUALITY made in Italy
SHAFT, GEAR CHANGE SIDE

VESPA 125 (VNA 1/2T '58>'59) - (VNB1T>6T '60>'66)
VESPA 150 (VBA1T '59>'60)(VBB1/2T '61>'66)
VESPA GT >60899 - VESPA SUPER 125 >024899 - SUPER 150 >70199 -
VESPA GL - VESPA SPRINT >73899



ART. 5825-A

CUSCINETTO (20x42x9) PER ASSE RUOTA POSTERIORE (Sim. 012501)

FOR REAR WHEEL AXLE

VESPA 50 - 125 VECCHI MODELLI / OLD MODELS



ART. 5825

CUSCINETTO SKF (20x42x9) PER ASSE RUOTA POSTERIORE (Sim. 012501)

FOR REAR WHEEL AXLE

VESPA 50 - 125 VECCHI MODELLI / OLD MODELS

VESPA PX PE



ART. 5042-KT

KIT DADO + SCODELLINO DI SICUREZZA
PER SERRAGGIO FRIZIONE

NUT + CUP SET, SEC. CLUTCH



ART. 5042

DADO FRIZIONE
CLUTCH NUT

(Sim. 20359)



ART. 5044

SCODELLINO DI SICUREZZA
PER DADO FRIZIONE
CUP FOR CLUTCH NUT

(Sim. 22313)



ART. 5039

DADO VOLANO CHIAVE 19
FLYWHEEL NUT, KEY 19

(Sim. 21112)

HIGH QUALITY
made in Italy

ESTRATTORI VOLANO E FRIZIONE
FLYWHEEL AND CLUTCH EXTRACTORS



ART. 3331

ATTREZZO IN ACCIAIO
PER SMONTAGGIO GHIERA FRIZIONE
STEEL TOOL FOR NUT CLUTCH DISMOUNT
VESPA PX PE TUTTI MODELLI DAL 1979



ART. 3332

ESTRATTORE FRIZIONE IN ACCIAIO
CON VITE IN ALTA RESISTENZA 8.8
CLUTCH STEEL EXTRACTOR WITH SCREW, HIGH RESISTANCE 8.8
VESPA 50-90 -125-PRIMAVERA - ET3
VESPA PK



ART. 3333

ESTRATTORE GRUPPO FRIZIONE IN ACCIAIO
CLUTCH ASSY STEEL EXTRACTOR
VESPA 50 - 90 - 125 - PRIMAVERA - ET3
VESPA PK



ART. 3334

ESTRATTORE FRIZIONE M23x1,5
CON VITE IN ALTA RESISTENZA
CLUTCH ASSY EXTRACTOR M23x1,5
WITH SCREW HIGH RESISTANCE
VESPA GS 150 - GS 160 - VESPA 180 SS



ART. 3340

ESTRATTORE VOLANO IN ACCIAIO
CON VITE IN ALTA RESISTENZA 8.8
FLYWHEEL STEEL EXTRACTOR
WITH SCREW, HIGH RESISTANCE 8.8
VESPA 125 E 150 DAL '70 IN POI
VESPA PX 125 E 150 - P200E - RALLY 200



TUBI COMANDO CAMBIO

GEAR SHIFT SLEEVE

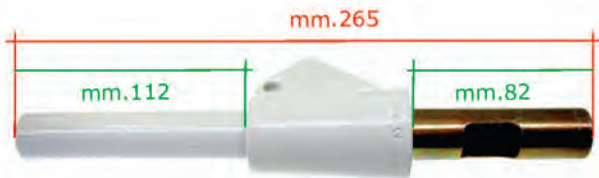

ART. **5450**

3 VELOCITA' / SPEED

(Sim.71073)

LUNGHEZZA / LENGHT mm.265

VESPA 50 (V5A1T ->881915)
VESPA 90 (V9A1T ->122983)



ART. **5451**

3 VELOCITA' / SPEED

(Sim.138011)

LUNGHEZZA / LENGHT mm.279

VESPA 50 (V5A1T 881916->)
VESPA 90 (V9A1T 121984->)

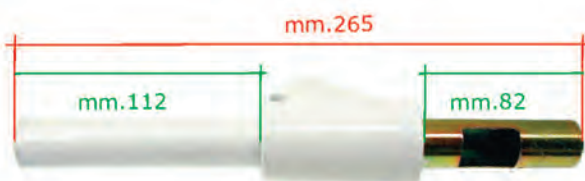

ART. **5452**

4 VELOCITA' / SPEED

(Sim.71176)

LUNGHEZZA / LENGHT mm.265

VESPA 50 S (V5SA1T ->67570)
VESPA 50 SPRINTER (V5SS2T)

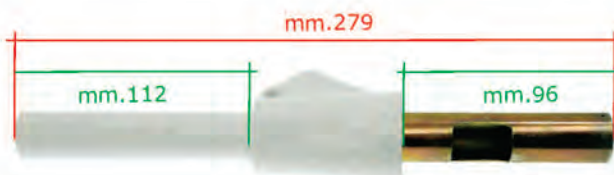

ART. **5456**

4 VELOCITA' / SPEED

(Sim.1382235)

LUNGHEZZA / LENGHT mm.279

VESPA 50 S (V5SA1T 67571->)



ART. **5454**

3 VELOCITA' / SPEED

(Sim.123258)

LUNGHEZZA / LENGHT mm.283

VESPA 50 SPECIAL (->FINO AL V5B3T 62019)

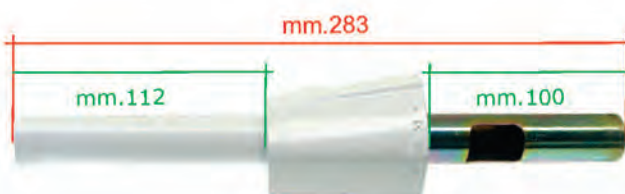

ART. **5453**

4 VELOCITA' / SPEED

(Sim.135935)

LUNGHEZZA / LENGHT mm.283

VESPA 50 SPECIAL (DAL V5B3T 62020)

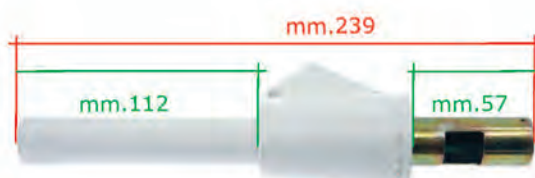

ART. **5455**

4 VELOCITA' / SPEED

(Sim.101537)

LUNGHEZZA / LENGHT mm.240

VESPA 50 SS - 90 SS

TUBI COMANDO CAMBIO

GEAR SHIFT SLEEVE

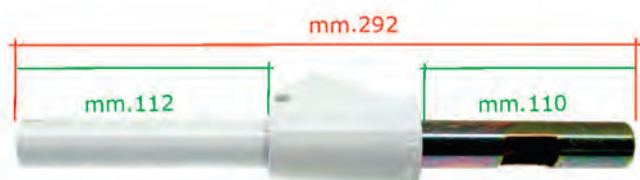

ART. **5460**

4 VELOCITA' / SPEED

(Sim.90538)

LUNGHEZZA / LENGHT mm.292

VESPA PRIMAVERA 125 (VMA2T->0135425)
 TS 125 (VNL3T->4174)-GL-125 GT/GTR - RALLY 180
 RALLY 200(->VSE1T 0025731) - SPRINT/SPRINT VELOCE
 SUPER 125(VNC1T)-SUPER 150 (VBC1T->356682)

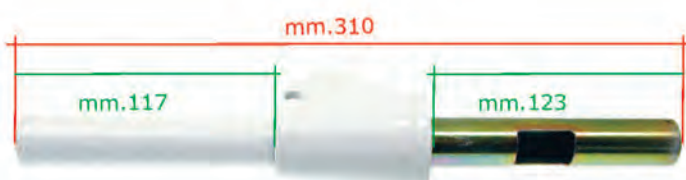

ART. **5463**

4 VELOCITA' / SPEED

(Sim.137840)

LUNGHEZZA / LENGHT mm. 310

VESPA PRIMAVERA 125 (VMA2T 0135426->)
 ET3 125 tutte/all - TS 125 (VNL3T -4175->)
 125 GTR (VNL2T 138889->)-RALLY 200 (VSE1T 0025732->)
 SPRINT (VLB1T 0228778->)-SUPER 150 (VBC1T 356683->)

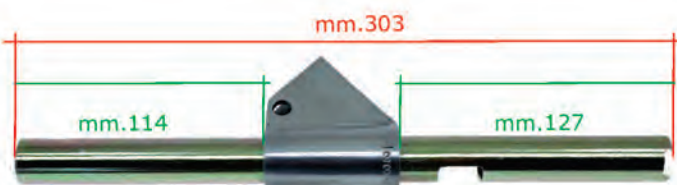

ART. **5458**

4 VELOCITA' / SPEED

(Sim.60555)

LUNGHEZZA / LENGHT mm. 303

VESPA 125 (DAL/FROM VNB3T)
 VESPA 150 (VB1T-VBA1T-VBB1T-VBB2T)
 VESPA GS 150 (VS2T->VS5T) - GS 160 (VSB1T)



ART. **6251**

3 VELOCITA' / SPEED

(Sim.247104)

LUNGHEZZA / LENGHT mm.298

VESPA RUSH 50 (V5X4T)
 VESPA N 50 (V5X5T)

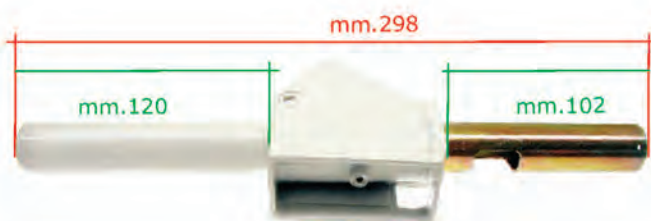

ART. **6250**

4 VELOCITA' / SPEED

(Sim.219336)

LUNGHEZZA / LENGHT mm.298

VESPA PK 50 (V5X1T) - PK 50 S (V5X2T)
 VESPA PK 50 SS (V5S1T) - PK 50 XL - PK 80S
 VESPA P125 ETS (VMS1T) - PK 125 (VMX1T)
 VESPA PK 125 S (VMX5T 3006137->) - PK 125 XL

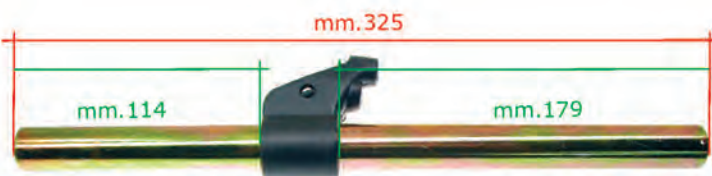

ART. **6254**

LUNGHEZZA / LENGHT mm. 325

(Sim. 266003)

VESPA FL 50 (V5N1T)
 VESPA FL 125 (VMX7T)
 VESPA FL2 HP 50 ('91-'97)

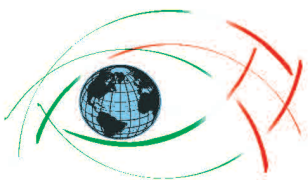

TUBI COMANDO CAMBIO

GEAR SHIFT SLEEVE

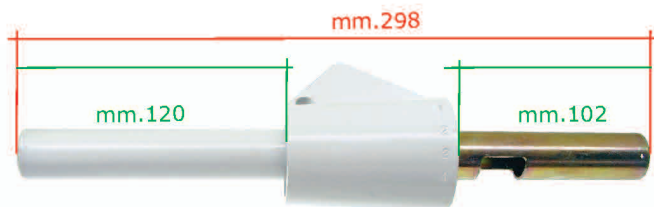

ART. **5459**

4 VELOCITA' / SPEED

(Sim. 139780)

LUNGHEZZA / LENGHT mm.300

PER VEICOLI SENZA LAMPEGGIATORI
FOR VEHICLES WITHOUT FLASHERS

VESPA PX 125 - 150 - PE 200

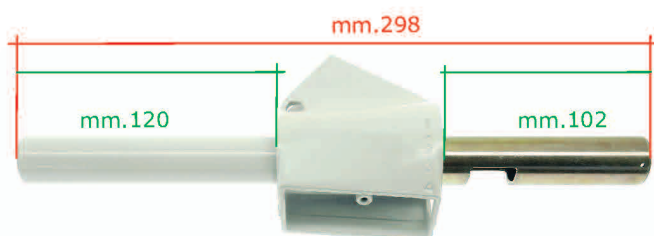

ART. **5461**

LUNGHEZZA / LENGHT mm.300

(Sim. 219356-139918)

CON SEDE PER COMANDO LAMPEGGIATORI
WITH SEAT FOR FLASHERS CONTROL

VESPA PX PE - ARCOBALENO
VESPA PX 30 ANNI 125 ('07-'08) - PX EU2 125 ('01-'07)



ART. **5447**

PIASTRA GUIDA CAVI AL MANUBRIO
HANDLEBAR CABLES GUIDE PLATE

VESPA 50 N-L-R (FARO TONDO)

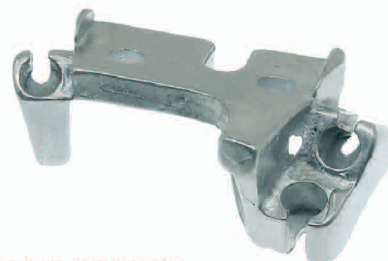

ART. **5448**

PIASTRA GUIDA CAVI AL MANUBRIO
HANDLEBAR CABLES GUIDE PLATE

VESPA 50 SPECIAL

**VESPA N 50 -PK 50-PK AUTOM. 50-PK XL 50/125-PK XL PLURIMATIC 50-RUSH 50
VESPA PX 125-150-PX 30 ANNI 125-PX EU2 125-PXE ARCOBALENO 125-T5 125**



ART. **5674**

CARRUCOLA PER INNESTO
CAVO COMANDO CAMBIO

PULLEY FOR CONNECTION
SHIFT CONTROL CABLE

(Sim. 139796)



ART. **5675**

CARRUCOLA PER INNESTO
CAVO COMANDO GAS

PULLEY FOR CONNECTION
SHIFT THROTTLE CABLE

(Sim. 139797)

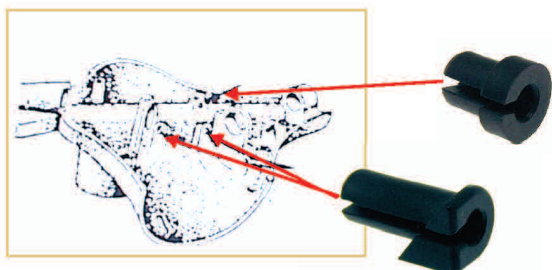

ART. **10336**

TERMINALE PASSACAVO
(situato parte interna coprimanubrio)
END GROMMET (positioned inside handlebar cover)

(Sim.139912)

ART. **10335**

TERMINALE PASSACAVO
(situato parte interna coprimanubrio)
END GROMMET (positioned inside handlebar cover)

(Sim.139913)

TUBI COMANDO GAS

THROTTLE SHIFT SLEEVE

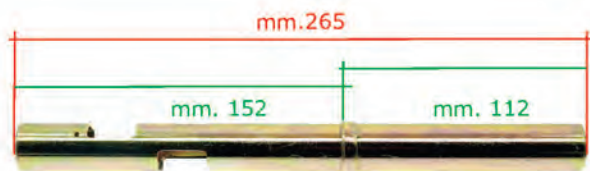

ART. **5476**

VESPA 50-50L-50 R (V5A1T ->881915) (FARO TONDO)
VESPA 50 S (V5SA1T ->67570)
VESPA 50 SPRINT (V5SS2T)
VESPA 90 (V9A1T ->122983)

PER VEICOLI 3 VELOCITA' / SPEED

(Sim. 70690)

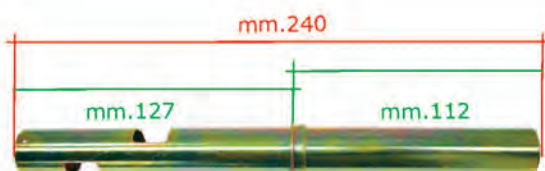

ART. **5466**

VESPA 50 SS - VESPA 90 SS

PER VEICOLI 4 VELOCITA' / SPEED

(Sim. 101464)



ART. **5473**

VESPA 50 SPECIAL (V5A2T-V5B1T-V5B3T ->62020)
VESPA 50 ELESTART (V5A3T - V5B2T)

PER VEICOLI 3 e 4 VELOCITA' / SPEED

(Sim. 123260)

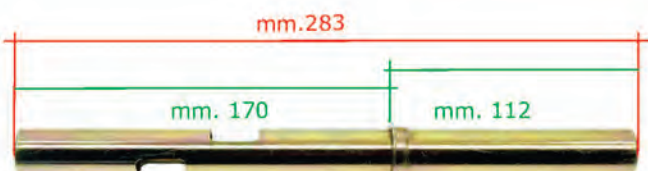

ART. **5477**

VESPA 50 SPECIAL (V5B3T 62021->)

(Sim. 137939)

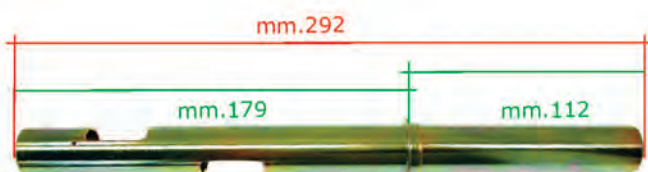

ART. **5470**

VESPA 125 PRIMAVERA (VMA2T ->0135425)
VESPA SUPER 125 (VNC1T)-SUPER 150 (VBC1T ->356682)
VESPA SPRINT (VLB1T)
VESPA SPRINT VELOCE (VLB1T 015001->0228777)
VESPA GL (VLA1T)
VESPA GT 125 (VNL2T)
VESPA GTR 125 (VNL2T 100001->138888)
VESPA RALLY 180 (VSD1T)
VESPA RALLY 200 (VSE1T ->0025731)

(Sim. 70589)



TUBI COMANDO GAS THROTTLE SHIFT SLEEVE

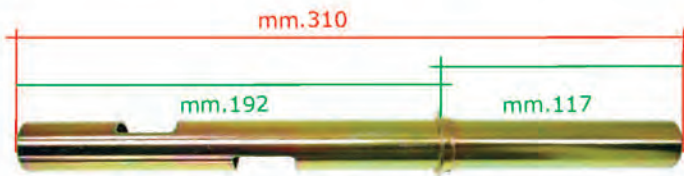

ART. 5474

VESPA 125 PRIMAVERA (VMA2T 0135426->)
VESPA 125 ET3 (VMB1T)
VESPA SUPER 150 (VBC1T 356683->)
VESPA SPRINT (VLB1T 0228778->)
VESPA GTR 125 (VNL2T 138889->)
VESPA 125 TS (VNL3T 4175->)
VESPA RALLY 200 (VSE1T 0025732->)

(Sim. 137842 - 175385)

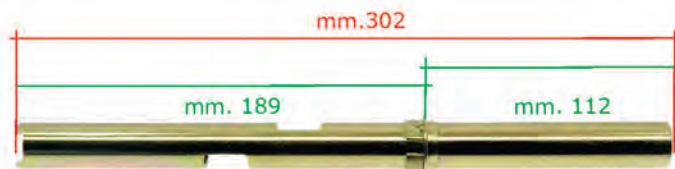

ART. 5478

VESPA 125 (DAL/FROM VNB3T)
VESPA 150 (VB1T-VBA1T-VBB1T-VBB2T)
VESPA GS 150 (VS2T->VS5T)
VESPA GS 160 (VSB1T)

(Sim. 60544)

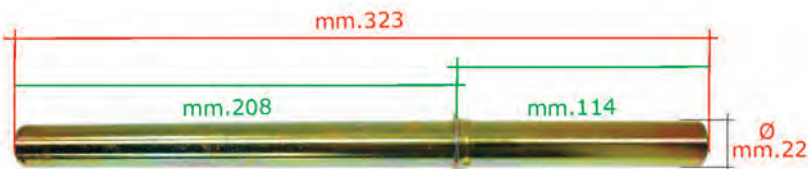

ART. 6255

VESPA FL 50 (V5N1T (1990))
VESPA 50 AUTOMATICA (V5P2T (1990))
VESPA FL 125 (VMX7 (1989))
VESPA HP FL2 HP 50 ('91-'97)

(Sim. 265991)

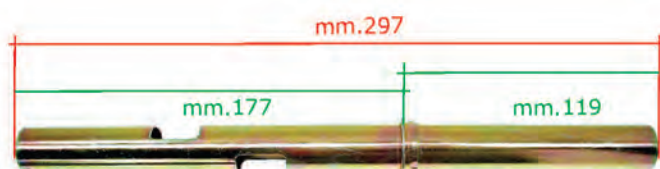

ART. 5475

VESPA PX PE - PX PE ARCOBALENO
VESPA PX 30 ANNI 125
VESPA PX EU2 125
VESPA PK 50 - RUSH 50 - N 50
VESPA PK AUTOMATICA 50
VESPA PK XL 50/125
VESPA PK XL PLURIMATIC 50

(Sim. 139778)

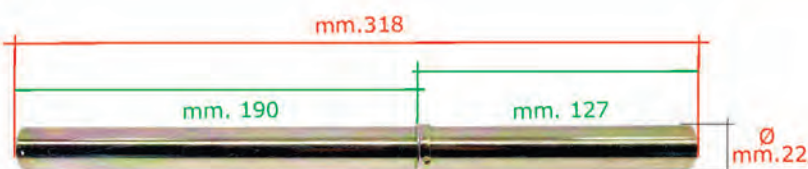

ART. 5479

VESPA COSA 2 125 ('91-'97)
VESPA COSA CL-CLX 125 ('88-'91)

(Sim. 228531)

COPPIE MANOPOLE

PAIR GRIPS



ART. **10247**

CP. MANOPOLE TIPO ORIG. NERA (CORTA)
PAIR GRIPS, BLACK COLOUR, ORIGINAL (SHORT TYPE)

VESPA 50 - 125 PRIMAVERA ET3-SUPER
APE 350-400-500-MPM-MPV

(Sim. 141924)



ART. **10242**

CP. MANOPOLE NERA
PAIR GRIPS, BLACK COLOUR

VESPA 50 - 125 PRIMAVERA ET3-SUPER
APE 350-400-500-MPM-MPV



ART. **10269**

CP. MANOPOLE TIPO ORIGINALE CON BORDINO
PAIR GRIPS, ORIGINAL TYPE

VESPA PK 50 (V5X1) - PK 125 (VMX1)
VESPA PK 50 S (V5X2) - PK 100 S (V9X1) - PK 125 S (VMX5)
VESPA PK 50 SS (V5S1) - PK 80 S (V8X5) - P 125 ETS (VMS1)

(Sim. 227077 - 178159)



ART. **10244**

CP. MANOPOLE NERA TIPO ORIG. (LUNGA)
PAIR GRIPS, BLACK COLOUR, ORIGINAL (LONG TYPE)

VESPA PX - PE - SUPER - GTR - SPRINT - RALLY

(Sim. 141923)

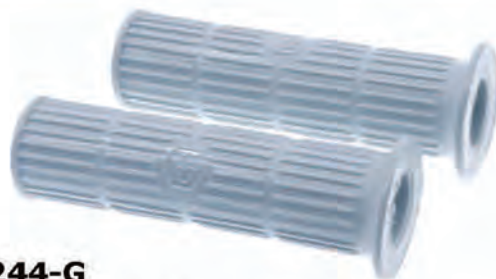

ART. **10244-G**

CP. MANOPOLE GRIGIA (LUNGA)
PAIR GRIPS, GREY COLOUR (LONG TYPE)

VESPA PX - PE - SUPER - GTR - SPRINT - RALLY



ART. **10270**

CP. MANOPOLE NERA TIPO ORIG. (LUNGA)
PAIR GRIPS, BLACK COLOUR, ORIGINAL (LONG TYPE)

VESPA PX 125E - PX 150E - PX 200E - SR. ARCOBALENO

(Sim. 179833)



ART. **10246-E**

COPPIA MANOPOLE CON TERMINALI CROMATI
PAIR GRIPS WITH CHROMED TERMINALS

VESPA PX MILLENNIUM - PX FRENO A DISCO

(Sim. 582324)



COPPIE MANOPOLE

PAIR GRIPS



ART. 10250-D21

CP. MANOPOLE GRIGIA
PAIR GRIPS, GREY COLOUR

Ø mm. **21** - LUNGHEZZA / LENGHT mm.123

VESPA 125 ('61-'66)
VESPA 150 ('57-'66)
VESPA GL 150
VESPA GS 160 - 180

(Sim. 060304)

ART. 10250-D24

CP. MANOPOLE GRIGIA
PAIR GRIPS, GREY COLOUR

Ø mm. **24** - LUNGHEZZA / LENGHT mm.123

VESPA 50 - 50 L - 50 R
VESPA 125 (VMA 1T-VNA/B 1T-2T)
VESPA 150 ('56)

(Sim. 028151)

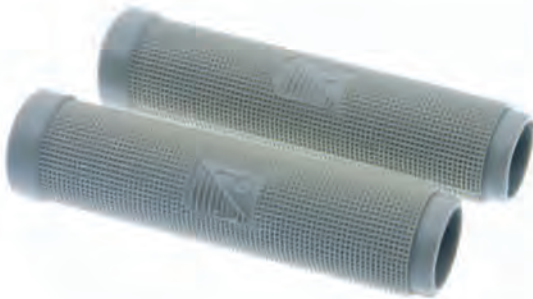

ART. 10248

CP. MANOPOLE GRIGIA
PAIR GRIPS, GREY COLOUR

Ø mm. **23** - LUNGHEZZA / LENGHT mm.125

VESPA 125 ('48-'57)

(Sim. 012153)



ART. 10249

CP. MANOPOLE GRIGIA
PAIR GRIPS, GREY COLOUR

Ø mm. **24** - LUNGHEZZA / LENGHT mm.120

VESPA 150 ('55-'56)
VESPA GS 150

(Sim. 022885)

LEVE FRENO E FRIZIONE

BRAKE AND CLUTCH LEVERS



ART. **5016**

CROMATA IN ALLUMINIO / CHROMED ALUMINIUM

(Sim. 33882)

VESPA 125 - 150 (1958->1965)
VESPA GS 150 - GS 160 tutti i modelli / all models



ART. **5015**

CROMATA IN ALLUMINIO / CHROMED ALUMINIUM

(Sim. 120487)

VESPA RALLY



ART. **5017-B**

CROMATA IN ALLUMINIO / CHROMED ALUMINIUM

(Sim. 70578)

VESPA 50 (1963->1969) - VESPA GL



ART. **5017-BF**

CROMATA IN ALLUMINIO CON FRESATURA FRONTALE
CHROMED ALUMINIUM WITH FRONT MILLING

VESPA 50 (1963->1969) - VESPA GL



ART. **5020**

CROMATA IN ALLUMINIO / CHROMED ALUMINIUM

VESPA 50
VESPA 125 PRIMAVERA (MODELLI/MODELS 1969->1975)



ART. **5017**

CROMATA IN ALLUMINIO / ALUMINIUM CHROMED

(Sim. 165279)

VESPA 50 SPECIAL
VESPA 125 PRIMAVERA ET3 (DAL / SINCE 1976->)



ART. **5014**

CROMATA IN ALLUMINIO / ALUMINIUM CHROMED

(Sim.138336
242531)

VESPA PX PE ARCOBALENO (FINO AL / TILL TO 1983)



ART. **5019**

CROMATA IN ALLUMINIO / ALUMINIUM CHROMED

(Sim.2425314
225340)

VESPA PX PE ARCOBALENO (DAL/SINCE '83->)
VESPA 125 T5



LEVE FRENO E FRIZIONE

BRAKE AND CLUTCH LEVERS

VESPA PX ARCOBALENO FRENO A DISCO / BRAKE DISC



ART. **5018-FS**

LEVA SINISTRA CROMATA IN ALLUMINIO
LEFT LEVER, CHROMED ALUMINIUM
(Sim. 2425314)



ART. **5018-FD**

LEVA DESTRA CROMATA IN ALLUMINIO
RIGHT LEVER, CHROMED ALUMINIUM
(Sim. 494804)

VESPA FL 50 ('90)-FL2 HP 50 ('91-'97)-AUTOMATICA 50 ('90-'91)-FL 125 ('89-'90)



ART. **10224**

LEVA FRIZIONE IN ALLUMINIO VERNICIATA
CLUTCH LEVER, PAINTED ALUMINIUM
(Sim. 265948)



ART. **10225**

LEVA FRENO IN ALLUMINIO VERNICIATA
BRAKE LEVER, PAINTED ALUMINIUM
(Sim. 265947)



ART. **10224-C**

LEVA FRIZIONE CROMATA
CHROMED CLUTCH LEVER
(Sim. 274489)



ART. **10225-C**

LEVA FRENO CROMATA
CHROMED BRAKE LEVER
(Sim. 274490)



ART. **5017-V**

VERNICIATA NERA IN ALLUMINIO / BLACK PAINTED IN ALUMINIUM
VESPA 50 SPECIAL - 125 PRIMAVERA ET3 (DAL/SINCE 1976->)



ART. **5014-V**

VERNICIATA NERA IN ALLUMINIO / BLACK PAINTED IN ALUMINIUM
VESPA PX PE ARCOBALENO (FINO AL / TILL TO 1983) - VESPA RALLY



ART. **5019-V**

VERNICIATA NERA IN ALLUMINIO / BLACK PAINTED IN ALUMINIUM
VESPA PX PE ARCOBALENO (DAL/SINCE 1983->) - VESPA 125 T5

LEVE FRENO E FRIZIONE

BRAKE AND CLUTCH LEVERS

VESPA 50 - 125 PRIMAVERA ET3 - PX



ART. **5027**

COPPIA CROMATA IN ALLUMINIO
PAIR CHROMED IN ALUMINIUM



ART. **5027-V**

COPPIA VERNICIATA NERA IN ALLUMINIO
PAIR BLACK PAINTED IN ALUMINIUM

VESPA PK - PK XL



ART. **5026**

COPPIA CROMATA IN ALLUMINIO
PAIR CHROMED IN ALUMINIUM



ART. **5026-V**

COPPIA VERNICIATA NERA IN ALLUMINIO
PAIR BLACK PAINTED IN ALUMINIUM

VESPA 50 SPECIAL - 125 PRIMAVERA ET3 (DAL/SINCE 1976->)



ART. **5017-SN**

SAGOMATA IN NYLON NERA
NYLON, BLACK COLOUR



ART. **5017-SB**

SAGOMATA IN NYLON BIANCA
NYLON, WHITE COLOUR

VESPA PX PE ARCOBALENO (FINO AL/TILL TO 1983) - VESPA RALLY



ART. **5014-SB**

SAGOMATA IN NYLON BIANCA
NYLON, WHITE COLOUR



VITI LEVE FRENO E FRIZIONE

BRAKE AND CLUTCH LEVERS SCREWS



ART. 5021

VITE TESTA CROCE CON DADO + RONDELLE
FISSA LEVE FRENO E FRIZIONE

VESPA TUTTI TIPI ESCLUSO VESPA PK

*SCREW WITH NUT FIXING BRAKE AND CLUTCH LEVER
ALL MODELS VESPA EXCEPT VESPA PK*



ART. 5025

VITE T.C. (A TAGLIO) CON DADO + RONDELLE
FISSA LEVE FRENO E FRIZIONE

VESPA TUTTI TIPI FINO AL 1972

*SCREW WITH NUT FIXING BRAKE AND CLUTCH LEVER
VESPA ALL MODELS TILL TO 1972*



ART. 5023

RONDELLA ORIGINALE ELASTICA BOMBATA
DI SCORRIMENTO (SUPERIORE)
PER LEVA FRENO FRIZIONE

*ELASTIC DOME WASHER OF SLIDE (UPPER)
FOR BRAKE AND CLUTCH LEVER*

VESPA TUTTI TIPI / ALL MODELS

(Sim. 017492)



ART. 5024

RONDELLA ORIGINALE PIANA
DI SCORRIMENTO (INFERIORE)
PER LEVA FRENO FRIZIONE

*PLAIN WASHER OF SLIDE (LOWER)
FOR BRAKE AND CLUTCH LEVER*

VESPA TUTTI TIPI / ALL MODELS

(Sim. 097734)

RUBINETTI BENZINA

FUEL COCKS

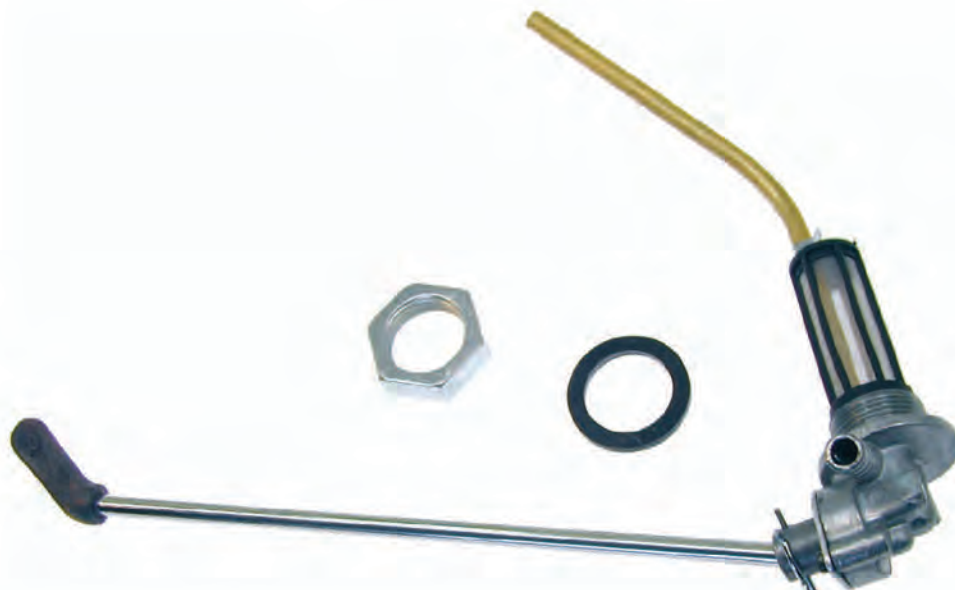

CIF ART.	Rif. Orig.	APPLICAZIONI / APPLICATIONS
5323	138937	RUBINETTO COMPLETO / COMPLETE FUEL COCK VESPA 50 - 90 - 125 PRIMAVERA - Et3
5326	138930	RUBINETTO COMPLETO / COMPLETE FUEL COCK VESPA PX - PE - PX PE SERIE ARCOBALENO
6241	214267	RUBINETTO COMPLETO / COMPLETE FUEL COCK VESPA PK - PK XL
6241-XL		RUBINETTO COMPLETO / COMPLETE FUEL COCK VESPA PK XL - RUSH



lunghezza / length mm. 200

ART. 5329

ASTA PER COMANDO RUBINETTO BENZINA
FUEL COCK ROD (lunghezza / length mm. 200)

VESPA 50 - 90 - 125 PRIMAVERA - ET3

(Sim. 98584)



lunghezza / length mm. 165

ART. 5330

ASTA PER COMANDO RUBINETTO BENZINA
FUEL COCK ROD (lunghezza / length mm. 165)

VESPA PK - PK XL - PX PE - PX PE ARCOBALENO

(Sim. 103202)



RICAMBI PER RUBINETTI BENZINA

FUEL COCKS SPARE PARTS



ART. 5343

GOMMINO NERO PER ASTA RUBINETTO BENZINA
GROMMET FOR FUEL COCK ROD, BLACK COLOUR

(Sim. 132538)

VESPA 50-125 ('67-'82) - PK 50 ('82-'84) - PK XL 50 ('85-'88)
VESPA PK XL 125 ('86-'89) - RUSH 50 ('88-'89)



ART. 5343-G

GOMMINO GRIGIO PER ASTA RUBINETTO BENZINA
GROMMET FOR FUEL COCK ROD, GREY COLOUR

VESPA VECCHI MODELLI



ART. 5342

GOMMINO NERO PER ASTA RUBINETTO BENZINA
GROMMET FOR FUEL COCK ROD, BLACK COLOUR

(Sim. 194631)

VESPA PXE ARCOBALENO 125/150/200E ('81-'97) - PX 125 ('98-'01)
VESPA PX EU2 125 ('01-'07) - PX 125/150 ('11-'17) - T5 125 ('85-'89)



ART. 5720

GUARNIZIONE PER RUBINETTO BENZINA
FUEL COCK GASKET

(Sim. 013836)

VESPA 50-90-125 PRIMAVERA - ET3 - PX PE



ART. 5720-V

GUARNIZIONE IN VITON PER RUBINETTO BENZINA
FUEL COCK VITON GASKET

(Sim. 013836)

VESPA 50 - 90 - 125 PRIMAVERA - ET3 - PX PE



ART. 7252

TIRANTE STARTER / STARTER TIE-ROD

(Sim. 98568)

VESPA 50 - 90 PRIMAVERA - ET3



ART. 7250

TIRANTE STARTER / STARTER TIE-ROD

(Sim. 266158)

VESPA PX PE - PX PE ARCOBALENO RALLY - SPRINT - SUPER
VESPA 125 DAL '60 - VESPA 150 DAL '59
APE MP - APE TM



ART. 7253

TIRANTE STARTER / STARTER TIE-ROD

(Sim. 580938)

APE FL/FL2 50 - FL3 EUROPA 50 - APE P50 - APE TM P50

OLD MODELS

RUBINETTI BENZINA

FUEL COCKS

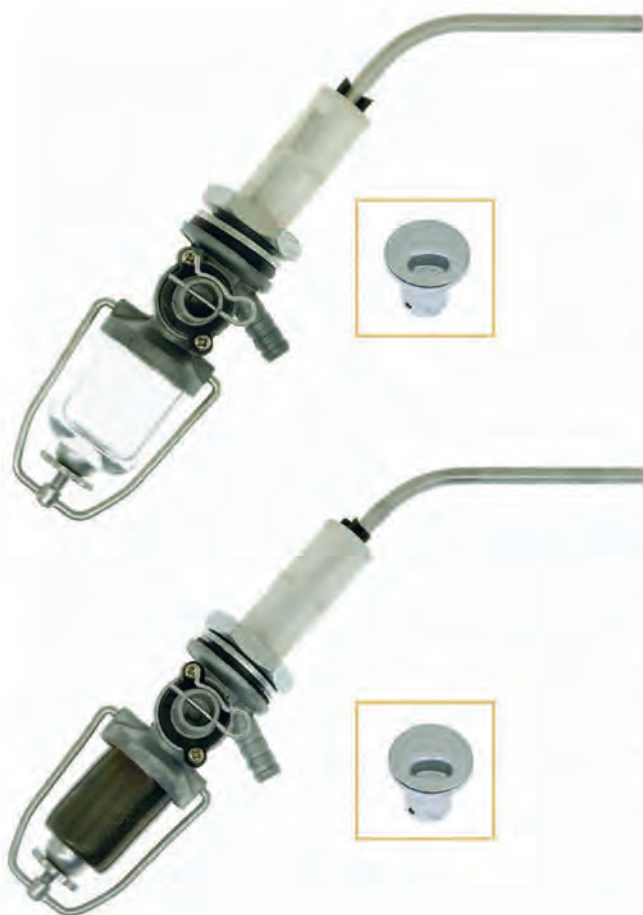

ART. 5298

RUBINETTO BENZINA CON **BICCHIERINO TRASPARENTE**
 COMPLETO DI: DADO + RONDELLA + GUARNIZIONE IN GOMMA

*FUEL COCK WITH TRANSPARENT CUP
 COMPLETE WITH NUT + WASHER + RUBBER GASKET*

VESPA 125 (VNB1->6) - GT - GTR - TS
 VESPA 150 (VBB1/2) - GL 150 - SPRINT (VLB1)
 VESPA SPRINT VELOCE - SUPER (VNC1)

ART. 5299

RUBINETTO BENZINA CON **BICCHIERINO IN ALLUMINIO**
 COMPLETO DI: DADO + RONDELLA + GUARNIZIONE IN GOMMA

*FUEL COCK WITH TRANSPARENT CUP
 COMPLETE WITH NUT + WASHER + RUBBER GASKET*

VESPA SUPER 125-150 (VNC1) - SPRINT VELOCE
 VESPA RALLY 180-200
 VESPA 125 (VNB1->6) - GT - GTR - TS
 VESPA 150 (VBB1/2) - GL 150 - SPRINT (VLB1)

OLD MODELS

ASTE TOTALMENTE IN ALLUMINIO

TOTALLY ALUMINIUM COCK RODS

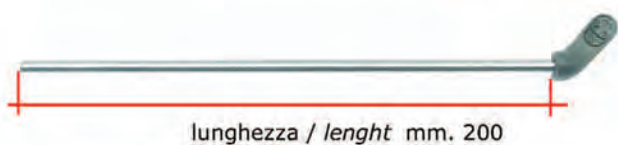

ART. **5331-C** ASTA per comando rubinetto benzina
 (lunghezza/lenght mm. 200)
 CON POMOLO COMANDO
 VESPA 50 (dal '63->) - PRIMAVERA (dal '68->'75)
 NUOVA VESPA 125 (dal '66->'67)



ART. **5331-B** ASTA per comando rubinetto benzina
 (lunghezza/lenght mm. 156)
 CON POMOLO COMANDO
 VESPA 125-150 ('51-'57)

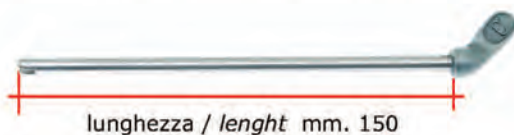

ART. **5331-A** ASTA per comando rubinetto benzina
 (lunghezza/lenght mm. 150)
 CON POMOLO COMANDO
 VESPA 125-150 ('59-'65)
 VESPA SPRINT ('59-'65)



CHIAVI IN ACCIAIO

STEEL KEYS

HIGH QUALITY

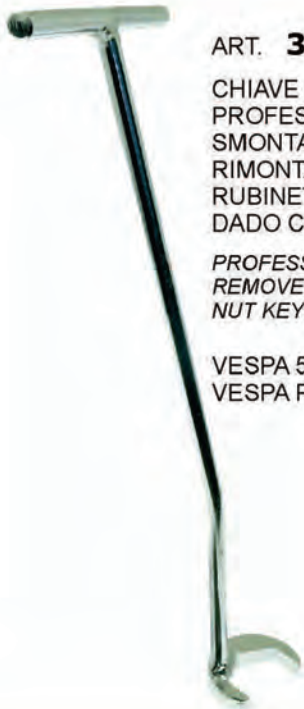

ART. **3314**

CHIAVE IN ACCIAIO
PROFESSIONALE
SMONTAGGIO E
RIMONTAGGIO
RUBINETTO BENZINA
DADO CHIAVE mm.32

PROFESSIONAL STEEL KEY
REMOVE AND REPLACE FUEL COCK
NUT KEY mm.32

VESPA 50 - 90 - 125 PRIMAVERA ET3
VESPA PX PE- SPRINT - GT - GTR - TS



ART. **3316**

CHIAVE IN ACCIAIO
PROFESSIONALE
SMONTAGGIO E
RIMONTAGGIO
RUBINETTO BENZINA
DADO CHIAVE mm.32

PROFESSIONAL STEEL KEY
REMOVE AND REPLACE FUEL COCK
NUT KEY mm.32

SPECIFICA PER / SPECIFIC FOR:
VESPA RALLY 180-200
VESPA 180 SS - VESPA GS 150 - 160

SERBATOIO BENZINA

TANK FUEL

HIGH QUALITY



ART. **15410**

SERBATOIO COMPLETO DI GUARNIZIONE
TANK FUEL COMPLETE WITH GASKET

VESPA 50 - 125 ('67-'82)
VESPA 50 S (V5SA1T '68-'82)
VESPA 50 L - R (V5A1T '70-'83)
VESPA 50 SPECIAL (V5B3T '75-'83)
VESPA 90 (V9A1T '78-'83)
VESPA 100 (V9B1T '78-'83)
VESPA 125 PRIMAVERA (VMA2T '67-'83)
VESPA 125 PRIMAVERA ET3 (VMB1T '76-'83)

(Sim.1386172)

ART. **5317**

GUARNIZIONE
PER SERBATOIO

TANK FUEL GASKET

(Sim. 71734)

VESPA 50-125 ('67-'82) - 50 S - 50 L - R - 50 SPECIAL
VESPA 90-125 PRIMAVERA - ET3



ART. **7235-K**

KIT POMELLO CHIUSURA
TAPPO SERBATOIO

KNOB KIT, CLOSING
TANK CAP

VARI MODELLI VESPA



HIGH QUALITY

SERBATOI BENZINA
TANKS FUEL



ART. **15412**

SERBATOIO BENZINA

(Sim. 2194672)

VESPA PX PE 125/150/200

TUTTI I MODELLI

CON GALLEGGIANTE E SENZA MIX

ALL MODELS

WITH FLOATER AND WITHOUT MIX



ART. **15414**

SERBATOIO BENZINA

(Sim. 2283725)

VESPA PX PE 125/150/200
VESPA 125 T5

TUTTI I MODELLI

CON GALLEGGIANTE E MIX

ALL MODELS

WITH FLOATER AND MIX



GUARNIZIONI SERBATOIO BENZINA

TANK FUEL GASKETS



Ø interno /internal mm.55
Ø esterno/external mm.73
spessore /thickness mm. 3

ART. **5335-GZ**

GUARNIZIONE TAPPO SERBATOIO BENZINA
TANK FUEL PLUG GASKET

(Sim.002319)

VESPA TUTTI MODELLI (DAL '46 AL '83)
VESPA 125 (VN1-VN2-VNA-VNB) - PX 125-150-P200E



mm. 325

ART. **9206**

GUARNIZIONE SERBATOIO SUGHERO-GOMMA
TANK FUEL GASKET, CORK-RUBBER MATERIAL

(spessore / thickness mm.4)

VESPA 125 (VM1-VM2 '53-'54)



mm. 400

ART. **9207**

GUARNIZIONE SERBATOIO SUGHERO-GOMMA
TANK FUEL GASKET, CORK-RUBBER MATERIAL

(spessore / thickness mm.4)

VESPA 125 (VN1-VN2) - VESPA 150 (VL2-3-VB1)

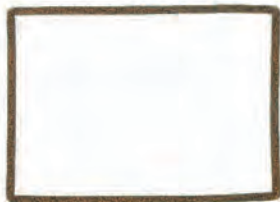

mm. 250

ART. **9208**

GUARNIZIONE SERBATOIO SUGHERO-GOMMA
TANK FUEL GASKET, CORK-RUBBER MATERIAL

(spessore / thickness mm.4)

VESPA 125 (CAMBIO A BACCHETTA) (V1/V15 '48-'50)
VESPA 125 (CAMBIO A FILO / WIRE GEAR) (V30/33 '51-'52)



ART. **9209**

GUARNIZIONE IN GOMMA / RUBBER GASKET

(Sim.159804)

VESPA 125/150 DAL1960
VESPA GT 125 - TS 125 - GL 150 - SUPER - GS 160- 180 SS
VESPA RALLY - VESPA PX 125 (DAL/FROM 1998) - PX EU2 125 ('01-'07)
VESPA PX 150 (DAL/FROM 2011) - VESPA PX 30 ANNI 125 ('07-'08)
VESPA PXE ARCOBALENO 125 ('81-'97) - VESPA 125 T5 ('85-'89)



ART. **5030**

VITE GALLETTO M6 / SCREW M6

(Sim. 015540)

VESPA 50

SERBATOIO OLIO

TANK OIL



ART. **15402**

SERBATOIO OLIO MISCELATORE COMPLETO
DI BICCHIERINO SPIA LIVELLO + GHIERA

(Sim.623139)

OIL TANK COMPLETE

VESPA PX 125-150-200
VESA PX 125-150 ('11-'16)
VESPA PX 30 ANNI 125
VESPA PXE ARCOBALENO 125-150-200
VESPA 125 T5



ART. **5332**

BICCHIERINO PER CONTROLLO LIVELLO OLIO
NEL SERBATOIO MISCELATORE

(Sim.623140-
155526)

*PLASTIC GLASS FOR CHECKING THE OIL LEVEL
IN THE TANK MIXER*

VESPA PX 125-150-200-PX PE ARCOBALENO-125 T5-RALLY



ART. **5355**

GUARNIZIONE PER BICCHIERINO SPIA OLIO MIX
GASKET FOR PLASTIC GLASS X CHECKING THE OIL LEVEL

(Sim.102587)

VESPA PX 125-150-200-PX PE ARCOBALENO-125 T5-RALLY



ZADI

ART. **5335**

TAPPO SERBATOIO CARBURANTE

(Sim.575825
242627
181903)

FUEL TANK PLUG

VESPA TUTTI MODELLI / ALL MODELS



ART. **5316**

GUARNIZIONE TAPPO SERBATOIO BENZINA
FUEL PLUG GASKET

VESPA FL 50 ('90) - FL 125 ('89-'90) - FL2 AUTOM.50 ('90-'91)
FL2 HP 50 ('91-'97) - N 50 ('89-'90) - PK AUTOMATICA 50 ('84-'89)
PK XL 50('85-'88) - PK XL 125 ('86-'89) - PK XL PLURIMATIC 50 ('85-'90)
PK RUSH XL 50 ('88-'89)-PX 125 ('98-'01)-PX 150 ('11)
PX 30 ANNI 125 ('07-'08) - PX EU2 125 ('01-07)
PXE ARCOBALENO 125 ('81-'97) - VESPA T5 125 ('85-'89)

Ø interno / internal mm.37,5
Ø esterno / external mm.51
spessore / thickness mm. 2,5



DEPURATORI ARIA

AIR CLEANER



ART. 6288

DEPURATORE ARIA COMPLETO DI:
FILTRO, FASCETTA, VITE E DADO

(Sim.197073)

AIR CLEANER COMPLETE WITH :
CLAMP, NUT, SCREW AND FILTER

VESPA PK - PK XL



ART. 6290

ELEMENTO FILTRANTE
PER SCATOLA DEPURATORE

(Sim.197072)

FILTER FOR AIR CLEANER BOX

VESPA PK - PK XL

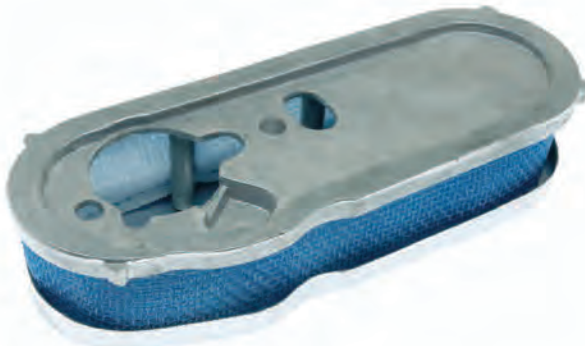

ART. 15406

FILTRO ARIA

(Sim.113125)

AIR FILTER

VESPA PX - PXE
VESPA PX ARCOBALENO
VESPA SPRINT (VLB1)
VESPA SUPER (VBC1)



ART. 6147-A

SPEZZONE cm.50
GUARNIZIONE PER DEPURATORE

(Sim.239049
058853)

GASKET FOR AIR CLEANER, CM.50

VESPA PX PE - SPRINT - RALLY

ART. 7514

TAPPO SCATOLA DEPURATORE
BOX CLEANER CAP

VESPA PX PE 125-150-200 E ARCOBALENO

(Sim. 050274)



ART. 7515

TAPPO COPERCHIO SCATOLA FILTRO
FILTER BOX CLEANER CAP

VESPA 50-90-125 PRIMAVERA - ET3

(Sim. 087975)



RACCORDI ASPIRAZIONE

UNION PIPES

VESPA 50 - 90 - 125 PRIMAVERA - ET3



∅ mm.19,5

ART. **5300** RACCORDO ASPIRAZIONE
per carburatore 16-10
VESPA 50

(Sim.416111)



∅ mm.21,5

ART. **5302** RACCORDO ASPIRAZIONE
per carburatore 16-16
VESPA 90

(Sim.78542)



∅ mm.23

ART. **5304** RACCORDO ASPIRAZIONE
per carburatore 19-19
VESPA 125 PRIMAVERA

(Sim.112869)



∅ mm.23

ART. **5308** RACCORDO ASPIRAZIONE
per carburatore 19-19
VESPA 125 PRIMAVERA Et3

(Sim.134125)

BOCCHETTONI IN ALLUMINIO

ALUMINIUM SLEEVES



ART. **5303** BOCCHETTONE IN ALLUMINIO per raccordo aspirazione
monta su carburatori 16-10 / 16-16
VESPA 50 -90

(Sim.110003)

ART. **5305** BOCCHETTONE IN ALLUMINIO per raccordo aspirazione
monta su carburatori 19-19
VESPA 125 PRIMAVERA ET3

(Sim.112517)



ART. **6228** BOCCHETTONE in alluminio per raccordo aspirazione
monta su carburatori 16-10 / 16-16
VESPA PK 50 - VESPA PK 50 XL - RUSH N

(Sim.178727)

ART. **6229** BOCCHETTONE in alluminio per raccordo aspirazione
monta su carburatori 19-19
VESPA PK 125 - VESPA PK 125 XL

(Sim.196778)



RACCORDI ASPIRAZIONE

UNION PIPES

VESPA PK 50 / 125



ART. **6225** RACCORDO ASPIRAZIONE
per carburatore **16-10**
VESPA PK 50

(Sim.178726)



ART. **6227** RACCORDO ASPIRAZIONE
PER **MODIFICA** / FOR **MODIFIED** carburatore **16-16**
VESPA PK 50



ART. **6226** RACCORDO ASPIRAZIONE
per carburatore **19-19**
VESPA PK 125

(Sim.196812)



ART. **6230** RACCORDO ASPIRAZIONE
PER **MODIFICA** / FOR **MODIFIED** carburatore **19-19**
SENZA BUSSOLE / WITHOUT BUSHES
VESPA PK 50

FLANGIA A 3 FORI / FLANGE 3 HOLES

VESPA PK 50 - PK 50/125 XL



ART. **6222** RACCORDO ASPIRAZIONE
per carburatore **16-10**
VESPA PK 50 - PK 50 XL

(Sim.430831)



ART. **6223** RACCORDO ASPIRAZIONE
PER **MODIFICA** / FOR **MODIFIED** carburatore **16-16**
VESPA PK 50 - PK 50 XL



ART. **6224** RACCORDO ASPIRAZIONE
per carburatore **19-19**
VESPA PK 125 - PK 125 XL

VESPA PK 125 FL2 - VESPA P125 ETS



ART. **6233** RACCORDO ASPIRAZIONE
per carburatore **SHBC 20L**
originale per : VESPA PK 125 FL2 - P125 ETS

(Sim.2247755)

MANICOTTI ASPIRAZIONE BELLOWS



ART. **5691**

MANICOTTO ASPIRAZIONE

VESPA 50 - 90 - 125 PRIMAVERA - ET3

(Sim. 71813)



ART. **6231**

MANICOTTO ASPIRAZIONE

VESPA PK 50 - 125 - RUSH -N - FL2

(Sim. 178694)



ART. **5973**

MANICOTTO ASPIRAZIONE

SPIRALE FINE
FINE SPIRAL

VESPA PX PE
VESPA GL

(Sim. 181476)



ART. **5973-ARC**

MANICOTTO ASPIRAZIONE

SPIRALE GROSSA
BIG SPIRAL

VESPA PX PE SR. ARCOBALENO
VESPA P 200 E
VESPA 125 T5

(Sim. 227205)



ART. **9742**

MANICOTTO ASPIRAZIONE

VESPA GS 150

(Sim. 024152)



ART. **9743**

MANICOTTO ASPIRAZIONE

VESPA GS 160 - VESPA 180 SS

(Sim. 077628)



CARBURATORI CARBURETORS

DELLORTO

SHB



ART. **12226** SHB 16-10 (DELL. 753) (Sim.97587)
VESPA 50
Getto massimo 51 (CIF art. 11051)

ART. **12228** SHB 16-16 (DELL. 764) (Sim.150600)
VESPA 50 SPECIAL
Getto massimo 74 (CIF art. 11074)



ART. **12235** SHB 16-10F (DELL. 917) (Sim.245425)
VESPA PK 50 XL
Getto massimo 53 (CIF art. 11054)

ART. **12232** SHB 16-16F (DELL. 879) (Sim.196930)
VESPA PK 50 XL
Getto massimo 70 (CIF art. 11070)

ART. **12236** SHB 16-12M (DELL. 926) (Sim.246940)
VESPA PK 50 RUSH - N
Getto massimo 53 (CIF art. 11054)

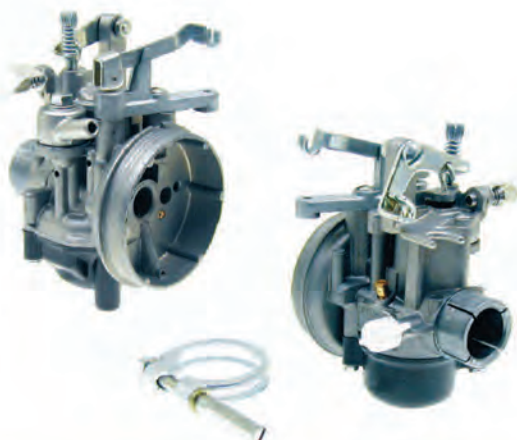

ART. **12216** SHB 16-12N (starter modificato) (DELL. 936) (Sim.286700)
VESPA PK 50 FL
Getto massimo 58 (CIF art. 11058)

DELLORTO

CARBURATORI

CARBURETORS

SHBC



ART. **12215** SHBC 19-19 (DELL. 773) (Sim.196227)
VESPA 125 PRIMAVERA
Getto massimo 74 (CIF art. 11074)



ART. **12205** SHBC 19-19E (DELL. 866) (Sim.178685)
VESPA PK 125
Getto massimo 73 (CIF art. 11074)



ART. **12218** SHBC 19-19E (starter modificato) (DELL. 943) (Sim.288173)
VESPA PK 125 FL
Getto massimo 72 (CIF art. 11072)



ART. **12297** SHBC 20L (starter a filo) (DELL. 941) (Sim.287152)
VESPA PK 125 FL2
Getto massimo 76 (CIF art. 11076)



ART. **12298** SHBC 20L (DELL. 909) (Sim.242951)
VESPA P125 ETS
Getto massimo 76 (CIF art. 11076)



CARBURATORI
CARBURETORS

DELLORTO

SI



ART. **12241** SI 20-20D (DELL. 587)
VESPA PX 125
Getto massimo 96 (CIF art. 13096)

ART. **12241-M** SI 20-20D con MIX (DELL. 585)
VESPA PX 125
Getto massimo 96 (CIF art. 13096)

ART. **12292** SI 20-20D (DELL. 588)
VESPA PX 150
Getto massimo 102 (CIF art. 13102)

ART. **12292-M** SI 20-20D con MIX (DELL. 590)
VESPA PX 150
Getto massimo 100 (CIF art. 13100)

ART. **12242** SI 24-24E (DELL. 586)
VESPA P 200 E
Getto massimo 118 (CIF art. 13118)

ART. **12242-M** SI 24-24E con MIX (DELL. 583)
VESPA P 200 E - PX 200 MIX
Getto massimo 116 (CIF art. 13116)



ART. **12293** SI 24-24G (DELL. 593)
VESPA T5 125
Getto massimo 110 (CIF art. 13110)

ART. **12293-M** SI 24-24G con MIX (DELL. 594)
VESPA T5 125
Getto massimo 110 (CIF art. 13110)

ART. **12289** SI 26-26E con MIX (DELL. 617)
VESPA PX PE 200
Getto massimo 120 (CIF art. 13120)

ART. **12290** SI 26-26G con MIX (DELL. 618)
VESPA T5 125
Getto massimo 110 (CIF art. 13110)

DELLORTO

CARBURATORI

CARBURETORS

PHBL



ART. 12276 PHBL 24 AS (DELL.2715)
 ATTACCO RIGIDO Ø 28,5
 REGOLAZIONE SINISTRA
 ADATTABILE VESPA
 Getto massimo 100 (CIF art. 12100)
 Getto minimo 50 (CIF art. 11050)



ART. 12275 PHBL 24 AD (DELL.2733)
 ATTACCO RIGIDO Ø 28,5
 REGOLAZIONE DESTRA
 ADATTABILE VESPA
 Getto massimo 100 (CIF art. 12100)
 Getto minimo 50 (CIF art. 11050)



ART. 12275-M PHBL 24 BD (DELL.2762)
 ATTACCO ELASTICO Ø 31
 REGOLAZIONE DESTRA
 ATTACCO MISCELATORE
 ADATTABILE VESPA
 Getto massimo 95 (CIF art. 12095)
 Getto minimo 50 (CIF art. 11050)



ART. 12272 PHBL 24 BS (DELL.2724)
 ATTACCO ELASTICO Ø 31
 STANDARD
 ADATTABILE VESPA E SCOOTER
 Getto massimo 100 (CIF art. 12100)
 Getto minimo 50 (CIF art. 11050)



ART. 12273-4T PHBL 24 AD (DELL.2716)
 ATTACCO RIGIDO DA Ø mm.31,75 A Ø mm.28,57
 STANDARD
 ADATTABILE VESPA E SCOOTER
 MOTORI **4 TEMPI / STROKE**
 Getto massimo 110 (CIF art. 12110)
 Getto minimo 50 (CIF art. 11050)

ART. 11522
 FASCETTA Ø mm. 34
 TESTA CACCIAVITE
 COMPLETA

SCREWDRIVER CLAMP ASSY

PER CARBURATORI
 (SHB 16 F - M - L - H)



ART. 11523
 FASCETTA Ø mm. 37
 TESTA CACCIAVITE
 COMPLETA

SCREWDRIVER CLAMP ASSY

PER CARBURATORI
 (SHBC 19E)

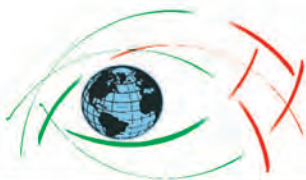

RICAMBI CARBURATORI

CARBURETORS SPARE PARTS

DELLORTO

SPILLI CHIUSURA BENZINA

NEEDLES

ART. 11500

TRIANGOLARE / TRIANGULAR



PER CARBURATORI
SHA - SHB 16 - SHBC 18/19/20
PHBG - FHBA - FHBB

VESPA 50 - 90 - 125 PRIMAVERA
VESPA PK
APE - CICLOMOTORI

(DELL. 2838)

ART. 11503

TRIANGOLARE MOLLEGGIATO
TESTA GROSSA TONDA mm. 3,5



TRIANGULAR, SPRINGY
BIG ROUND HEAD Ø mm. 3,5

PER CARBURATORI
VESPA 50 - 90 - 125 PRIMAVERA
VESPA PK

(DELL. 11668)

ART. 11502

QUADRATO
QUADRO / SQUARE mm. 3,5



PER CARBURATORI
VESPA PX

(DELL. 4559)

ART. 11504

QUADRATO MOLLEGGIATO
QUADRO mm. 3,5
TESTA TONDA mm. 3,5



SQUARE, SPRINGY
SQUARE mm. 3,5
ROUND HEAD mm.3,5

PER CARBURATORI
VESPA PX - APE

(DELL. 8080)

ART. 11501

QUADRATO MOLLEGGIATO
QUADRO mm. 4
TESTA TONDA mm. 3,5



SQUARE SPRINGY NEEDLE
SQUARE mm.4 - ROUND HEAD mm.3,5

PER CARBURATORI
VESPA COSA

(DELL. 12202)

GETTI PER CARBURATORI

CARBURETORS JETS

TIPO PICCOLO FILETTO mm. 5 SMALL TYPE, THREAD mm. 5

(DELL. 1486)

Articolo	Variante
11040	40
11042	42
11044	44
11046	46
11048	48
11050	50
11051	SPECIFICO/SPECIFIC: VESPA 50
11052	52
11054	54
11056	56
11058	58
11060	60
11062	62
11064	64
11066	66
11068	68
11070	70
11072	72
11074	74
11076	76
11078	78
11080	80
11082	82
11085	85
11087	87
11090	90
11092	92
11095	95
11098	98
11100	100
11102	102
11105	105
11108	108
11110	110
11112	112
11115	115
11118	118
11120	120
11122	122
11125	125
11130	130



Confezione minima 10 pz.

GETTO MASSIMO MAXIMUM JET

(DELL. 4576)

PER CARBURATORI SERIE SI 20 - 22 - 24
VESPA PX PE

Articolo	Variante
13090	90
13092	92
13095	95
13098	98
13100	100
13102	102
13105	105
13108	108
13110	110
13118	118
13120	120



Confezione minima 4 pz.



FILETTO/THREAD mm.5

GETTO MINIMO CON CALIBRAZIONE ARIA

IDLE JET WITH AIR CALIBRATION

VESPA PX

ART. 13200-01	VAR.01 (48/160)	per carburatori SI 20..D - SI 24..E-G	(DELL.09892.01)
ART. 13200-04	VAR.04 (55/160)	per carburatori SI 20..D - SI 24..E-G	(DELL.09892.04)
ART. 13200-05	VAR.05 (38/120)	per carburatori SI 20..D - SI 24..E-G	(DELL.09892.05)
ART. 13200-07	VAR.07 (52/140)	per carburatori SI 20..D - SI 24..E-G	(DELL.09892.07)
ART. 13200-08	VAR.08 (45/140)	per carburatori SI 20..D - SI 24..E-G	(DELL.09892.08)
ART. 13200-09	VAR.09 (50/160)	per carburatori SI 20..D - SI 24..E-G	(DELL.09892.09)
ART. 13200-11	VAR.11 (48/140)	per carburatori SI 20..D - SI 24..E-G	(DELL.09892.11)
ART. 13200-12	VAR.12 (52/120)	per carburatori SI 20..D - SI 24..E-G	(DELL.09892.12)
ART. 13200-16	VAR.16 (45/120)	per carburatori SI 20..D - SI 24..E-G	(DELL.09892.16)



FILETTO/THREAD mm.5

GETTO MINIMO

IDLE JET

VESPA - APE

ART. 13300-35	VAR.35	per carburatori SHB 16 F-G-H-L-M-N - SHBC 18-19-20	(DELL.03360.35)
ART. 13300-38	VAR.38	per carburatori SHB 16 F-G-H-L-M-N - SHBC 18-19-20	(DELL.03360.38)
ART. 13300-40	VAR.40	per carburatori SHB 16 F-G-H-L-M-N - SHBC 18-19-20	(DELL.03360.40)
ART. 13300-42	VAR.42	per carburatori SHB 16 F-G-H-L-M-N - SHBC 18-19-20	(DELL.03360.42)
ART. 13300-45	VAR.45	per carburatori SHB 16 F-G-H-L-M-N - SHBC 18-19-20	(DELL.03360.45)
ART. 13300-48	VAR.48	per carburatori SHB 16 F-G-H-L-M-N - SHBC 18-19-20	(DELL.03360.48)
ART. 13300-50	VAR.50	per carburatori SHB 16 F-G-H-L-M-N - SHBC 18-19-20	(DELL.03360.50)
ART. 13300-55	VAR.55	per carburatori SHB 16 F-G-H-L-M-N - SHBC 18-19-20	(DELL.03360.55)



FILETTO/THREAD mm.8

CALIBRATORE ARIA MASSIMO

AIR CALIBRATOR JET

VESPA 125 T5

ART. 13400-120	VAR.120	per carburatori SI 24-24 G - SI 26-26 G	(DELL.04581.120)
-----------------------	---------	---	------------------



FILETTO/THREAD mm.8

CALIBRATORE ARIA MASSIMO

AIR CALIBRATOR JET

VESPA PX

ART. 13500-120	VAR.120	per carburatori SI 20..D-H - SI 24..E-G-H	(DELL.05827.120)
ART. 13500-140	VAR.140	per carburatori SI 20..D-H - SI 24..E-G-H	(DELL.05827.140)
ART. 13500-160	VAR.160	per carburatori SI 20..D-H - SI 24..E-G-H	(DELL.05827.160)
ART. 13500-190	VAR.190	per carburatori SI 20..D-H - SI 24..E-G-H	(DELL.05827.190)



RICAMBI CARBURATORI
CARBURETORS SPARE PARTS

DELLORTO

GETTO AVVIAMENTO

CHOKE JET



FILETTO/THREAD mm.6

VESPA PX

ART. **13600-60** VAR. 60 per carburatori SI 20..D - SI 24..E-G VESPA PX (DELL.05582.60)

GETTO AVVIAMENTO

CHOKE JET



FILETTO/THREAD mm.5

VESPA - APE

ART. **13700-50** VAR. 50 per carburatori SHB 16 F-G-H-L-M-N - SHBC 18-19-20 VESPA - APE (DELL.06217.50)
ART. **13700-60** VAR. 60 per carburatori SHB 16 F-G-H-L-M-N - SHBC 18-19-20 VESPA - APE (DELL.06217.60)

GETTO AVVIAMENTO

CHOKE JET



FILETTO/THREAD mm.5

ART. **13800-45** VAR. 45 per carburatori PHBH - PHBL - PHS - PHM (DELL.07746.45)
ART. **13800-50** VAR. 50 per carburatori PHBH - PHBL - PHS - PHM (DELL.07746.50)
ART. **13800-55** VAR. 55 per carburatori PHBH - PHBL - PHS - PHM (DELL.07746.55)
ART. **13800-60** VAR. 60 per carburatori PHBH - PHBL - PHS - PHM (DELL.07746.60)
ART. **13800-65** VAR. 65 per carburatori PHBH - PHBL - PHS - PHM (DELL.07746.65)

EMULSIONATORE

MIXER TUBE



VESPA PX

ART. **13900-01** BE MIS.1 per carburatori SI 20..D-H - SI 24..E-G-H VESPA PX (DELL.05353.BE1)
ART. **13900-02** BE MIS.2 per carburatori SI 20..D-H - SI 24..E-G-H VESPA PX (DELL.05353.BE2)
ART. **13900-03** BE MIS.3 per carburatori SI 20..D-H - SI 24..E-G-H VESPA PX (DELL.05353.BE3)
ART. **13900-05** BE MIS.5 per carburatori SI 20..D-H - SI 24..E-G-H VESPA PX (DELL.05353.BE5)

DELLORTO

RICAMBI CARBURATORI

CARBURETORS SPARE PARTS



ART. 11510

PIPETTA DI RACCORDO fra TUBO BENZINA e CARBURATORE (Dell. 10918)

PIPET CONNECTION BETWEEN FUEL TUBE AND CARBURETOR

per carburatori (SHB 16 F)

VESPA PK



ART. 11511

PIPETTA DI RACCORDO fra TUBO BENZINA e CARBURATORE (Dell. 6517)

PIPET CONNECTION BETWEEN FUEL TUBE AND CARBURETOR

per carburatori (SHBC 18 A-18 C-18 D)-(SHBC 19-19 B-19 D)

VESPA - APE



ART. 11507-A

FILTRINO SOTTO LA PIPETTA

(Dell. 6210)

SMALL FILTER UNDER THE PIPET

per carburatori (SHB 16 - 16 F - SHB 16 G - 16 H - 16 L)

VESPA



ART. 11506

FILTRINO SOTTO LA PIPETTA

(Dell. 6109)

SMALL FILTER UNDER THE PIPET

per carb.(SHA 15 C ..)(SHBC 18 A-18 B-18 D) (SHBC 19..19 B - 19 D)

VESPA - APE



ART. 11520

FILTRO BENZINA / *FUEL FILTER*

(Dell.04187.29)

per carburatori (SI 20-24 E,D,G,H)

VESPA PX PE



ART. 11531

GALLEGGIANTE / *FLOAT*

(Dell. 6122.80.01)

per carburatori (SHA 14.. - 15.. - SHB 16.. - SHBC 19..)

VESPA TUTTI TIPI - CICLOMOTORI VARI



ART. 11534

GALLEGGIANTE / *FLOAT*

(Dell. 4567.80)

per carburatori

VESPA PX PE TUTTI TIPI / *ALL MODELS*



RICAMBI CARBURATORI

CARBURETORS SPARE PARTS

DELLORTO



ART. **11552**

VASCHETTA CON GUARNIZIONE
FLOAT CHAMBER WITH GASKET

(Dell. 13502.96)

per carburatori (SHBC ...)

VESPA TUTTI TIPI



ART. **11645**

COPERCHIO VASCHETTA CARBURATORE
FLOAT CHAMBER COVER

(Dell.1181900-954)

per carburatori (SI 20..-24.. D-E-G)

CON E SENZA MISCELATORE / WITH AND WITHOUT MIX

VESPA PX - PX PE



ART. **11560**

VITE FISSAGGIO VASCHETTA
SCREW FIX FLOAT CHAMBER

(Dell. 11837.36)

per carburatori VESPA TUTTI MODELLI / ALL MODELS
CIAO-SI'-CICLOMOTORI VARI



ART. **11545**

MOLLA RICHIAMO VALVOLA GAS
SPRING FOR THROTTLE VALVE

(Dell.6455.61)

per carburatori (SHB 16) VESPA 50 - PK 50

ART. **11548**

MOLLA RICHIAMO VALVOLA GAS
SPRING FOR THROTTLE VALVE

(Dell.5951.61)

per carburatori (SHB 19-SHBC 19) VESPA PRIMAVERA - ET3 - PK 125



ART. **11547**

MOLLA TENUTA VITE REGOLAZIONE MINIMO
SPRING FOR SCREW ADJUSTMENT MINIMUM FUEL

(Dell. 9336.61)

per carburatori (SHB.. - SHBC.. - PHBG) VESPA e vari



ART. **11541**

VITE PER REGOLAZIONE MINIMO
SCREW FOR ADJUSTMENT MINIMUM FUEL

(Dell.3357.33)

per carburatori (SHB .. - SHBC .. - 16.. - 19.) VESPA PK

DELLORTO

RICAMBI CARBURATORI
CARBURETORS SPARE PARTS



ART. 11622
SERIE GUARNIZIONI
REVISIONE CARBURATORI
per carburatori SHB 16
VESPA e altri
(Dell. 52541)



ART. 11623
SERIE GUARNIZIONI
REVISIONE CARBURATORI
per carburatori SHBC 18 - 19 - 20 B - E
VESPA PK - APE
(Dell. 52553)

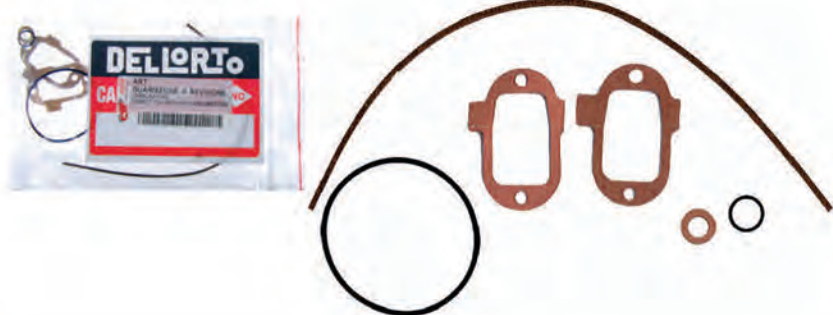

ART. 11624
SERIE GUARNIZIONI
REVISIONE CARBURATORI
per carburatori SHBC 18-19 D
VESPA APE
(Dell. 52555)



ART. 11627
SERIE GUARNIZIONI
REVISIONE CARBURATORI
per carburatori SI 20 - SI 24
VESPA PX PE
VESPA 125/150 DAL '62>
VESPA GL - VESPA SPRINT
(Dell. 52537)



CAVALLETTI CENTRALI

CENTRAL STANDS

VESPA 50 - 90 - 125 PRIMAVERA - ET3



ART. **5496**
CAVALLETTO CENTRALE
CROMATO / CHROMED
(Sim. 135384)



ART. **5496-Z**
CAVALLETTO CENTRALE
ZINCATO / ZINCED
(Sim. 135384)



ART. **5496-N**
CAVALLETTO CENTRALE
NERO / BLACK
(Sim. 135384)

VESPA FINO AL / TILL TO 1971

VESPA 50 (V5A1T) (V5SA1) (V5SS1) - VESPA 90 - NUOVA 125 (VMA1T)



ART. **5492**
CAVALLETTO CENTRALE RINFORZATO
ZINCATO / ZINCED

TUBO / TUBE Ø mm.16
SPESSORE / THICKNESS mm.3

CAVALLETTI CENTRALI

CENTRAL STANDS

VESPA PK - PK XL - RUSH - N - HP - FL



ART. **6182**

CAVALLETTO CENTRALE

(Sim.216247)

NERO / BLACK

VESPA PXE ARCOBALENO 125-150-200 (1981-1997) - PX 125 (1998-2001)
VESPA PX EURO 2 125 (2001-2007) - VESPA PX 30 ANNI 125 (2007-2008)
VESPA PX 125-150 (2011-2017) - VESPA 125 T5



ART. **5499**

CAVALLETTO CENTRALE

(Sim.176160)

MODELLO ORIGINALE DOPPIA PIASTRINA
 ORIGINAL MODEL WITH DOUBLE BRACKET

NERO / BLACK



ART. **5499-Z**

CAVALLETTO CENTRALE

MODELLO ORIGINALE DOPPIA PIASTRINA
 ORIGINAL MODEL WITH DOUBLE BRACKET

ZINCATO / ZINCED



ART. **5707**

TAMPONE PARACOLPI CAVALLETTO

(Sim.174773)



CAVALLETTI CENTRALI

CENTRAL STANDS

VESPA SPRINT - SUPER - RALLY 180/200 - GTR - TS



ART. **5497**

CAVALLETTO CENTRALE

(Sim. 91047)

CROMATO / CHROMED

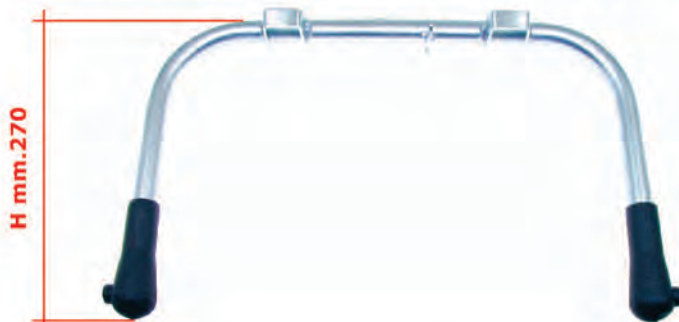

ART. **5497-Z**

CAVALLETTO CENTRALE

ZINCATO / ZINCED

VESPA SUPER 125/150 - VESPA 125 (DAL VNB3T->) - VESPA 150 (VBB1T)



ART. **5494-Z**

CAVALLETTO CENTRALE

ZINCATO / ZINCED

TUBO / TUBE \varnothing mm.20

RUOTA / WHEEL 8"

VESPA COSA 1-2



ART. **6180**

CAVALLETTO CENTRALE

(Sim. 2533615)

NERO / BLACK

COPPIE PIEDINI CAVALLETTO

STAND PADS (PAIR)



ART. **5501**

COPPIA PIEDINI IN GOMMA PER CAVALLETTO
STAND PADS (PAIR) IN RUBBER

(Sim.135387)

Ø INTERNO / INTERNAL mm. 20

VESPA 50 - 90 - 125 PRIMAVERA - 125 PRIMAVERA ET3



ART. **5503**

CP. PIEDINI IN GOMMA FORO PICCOLO PER CAVALLETTO
STAND PADS (PAIR) IN RUBBER, SMALL HOLE

(Sim.610281M)

Ø INTERNO / INTERNAL mm.16

VESPA FINO AL / TILL TO 1971
VESPA 50 (V5A1T) (V5SA1) (V5SS1) - VESPA 90 - 125 (VMA1T)



ART. **5509**

CP. PIEDINI IN GOMMA FORO PICCOLO PER CAVALLETTO
STAND PADS (PAIR) IN RUBBER, SMALL HOLE

Ø INTERNO / INTERNAL mm.16

VESPA DAL 1953 AL 1959
VESPA 125 (VM1/2) - VESPA 150 (VL1/2/3)
VESPA 150 (VB1) - GS 150 (VS1/2/3/4/5) - (VBA '59) (VNA)



ART. **5502**

COPPIA PIEDINI IN GOMMA PER CAVALLETTO
STAND PADS (PAIR) IN RUBBER

(Sim.54146+54147)

Ø INTERNO / INTERNAL mm. 20

VESPA SPRINT - SUPER - RALLY 180 - 200 - GTR - TS



ART. **5505-HQ**

COPPIA PIEDINI **HIGH QUALITY** CON FONDELLO IN TEFLON
AD ALTA RESISTENZA ANNEGATO NELLA MESCOLA DI STAMPAGGIO
STAND PADS (PAIR) **HIGH QUALITY** WITH HIGH RESISTANCE TEFLON BOTTOM
DROWNED IN THE MOLDING COMPOUND

(Sim.176166)

Ø INTERNO / INTERNAL mm. 22

VESPA PK - PK XL 50 FL - RUSH - N - HP
VESPA PX PE - PX PE ARCOBALENO - 125 T5 - VESPA COSA



ART. **5505**

COPPIA PIEDINI IN GOMMA PER CAVALLETTO
CON FONDELLO ANNEGATO

(Sim.176166)

STAND PADS (PAIR) IN RUBBER WITH BOTTOM COVER DROWNED

Ø INTERNO / INTERNAL mm. 22

VESPA PK - PK XL 50 FL - RUSH - N - HP
VESPA PX PE - PX PE ARCOBALENO - 125 T5 - VESPA COSA



MOLLE-PIASTRINE CAVALLETTO

CENTRAL STANDS SPRINGS AND BRACKETS

ART. 5493

MOLLA
ritorno cavalletto centrale
central stand SPRING



VESPA 50-90-125 PRIMAVERA
VESPA 125 PRIM. ET3-TS

(Sim. 77269)

ART. 5495

MOLLA
ritorno cavalletto centrale
central stand SPRING



VESPA PX PE
VESPA PX PE ARCOBALENO

(Sim. 176169)

ART. 6184

MOLLA
ritorno cavalletto centrale
central stand SPRING



VESPA PK - PK XL
VESPA FL - RUSH - N - HP

(Sim. 216255)

ART. 5495-DM

MOLLA
ritorno cavalletto centrale
central stand SPRING



VESPA PX 125/150 TUTTE DAL 1998 - VESPA 125 T5

(monta su cavalletti a 2 molle e con doppia piastrina)
(mounts on stand at 2 springs and with double plate)

(Sim. 176444)



ART. 5500

COPPIA PIASTRINE ANCORAGGIO CAVALLETTO (Ø 20 mm.)

BRACKETS (PAIR), TO FIX CENTRAL STAND

VESPA 50 - 90 - 125 PRIMAVERA - ET3
E TUTTI I MODELLI COMPRESI NELLA PRODUZIONE DAL '66 AL '76
AND ALL MODELS INCLUDED IN PRODUCTION FROM '66 TO '76

(Sim. 135389)



ART. 6185

COPPIA PIASTRINE ANCORAGGIO CAVALLETTO (Ø 22 mm.)

BRACKETS (PAIR), TO FIX CENTRAL STAND

VESPA PK - PK XL - FL - RUSH - N - HP

(Sim. 233120-216252)



ART. 5504-A

COPPIA PIASTRINE ANCORAGGIO CAVALLETTO (Ø 22 mm.)

BRACKETS (PAIR), TO FIX CENTRAL STAND

VESPA PX PE - PX PE ARCOBALENO - VESPA 125 T5

(Sim. 176167-176168)



ART. 6186

COPPIA PIASTRINE ANCORAGGIO CAVALLETTO (Ø 16 mm.)

BRACKETS (PAIR), TO FIX CENTRAL STAND

VESPA 50 L - N - R - VESPA 90 - VESPA 125 (VMA1T '65-'67)

(Sim. 610282M)

**LAMIERA GREZZA
STEEL RAW**

**FONDI PEDANA
FLOOR BOARD**



ART. **15900**

FONDO PEDANA IN LAMIERA GREZZA / STEEL RAW
SPESSORE / THICKNESS mm. 1

VESPA 50 - 90 - 125 PRIMAVERA - ET3



**** TECHNICAL INFORMATION ****

- 1) FORI PER SCARICO RESIDUI VAPORI BENZINA
 - 2) ASOLA PER PIASTRINA ATTACCO MOLLA CAVALLETTO
- 1) DISCHARGE RESIDUES FUEL VAPORS HOLES
 - 2) SPRING FIXING STAND PLATE HOLE

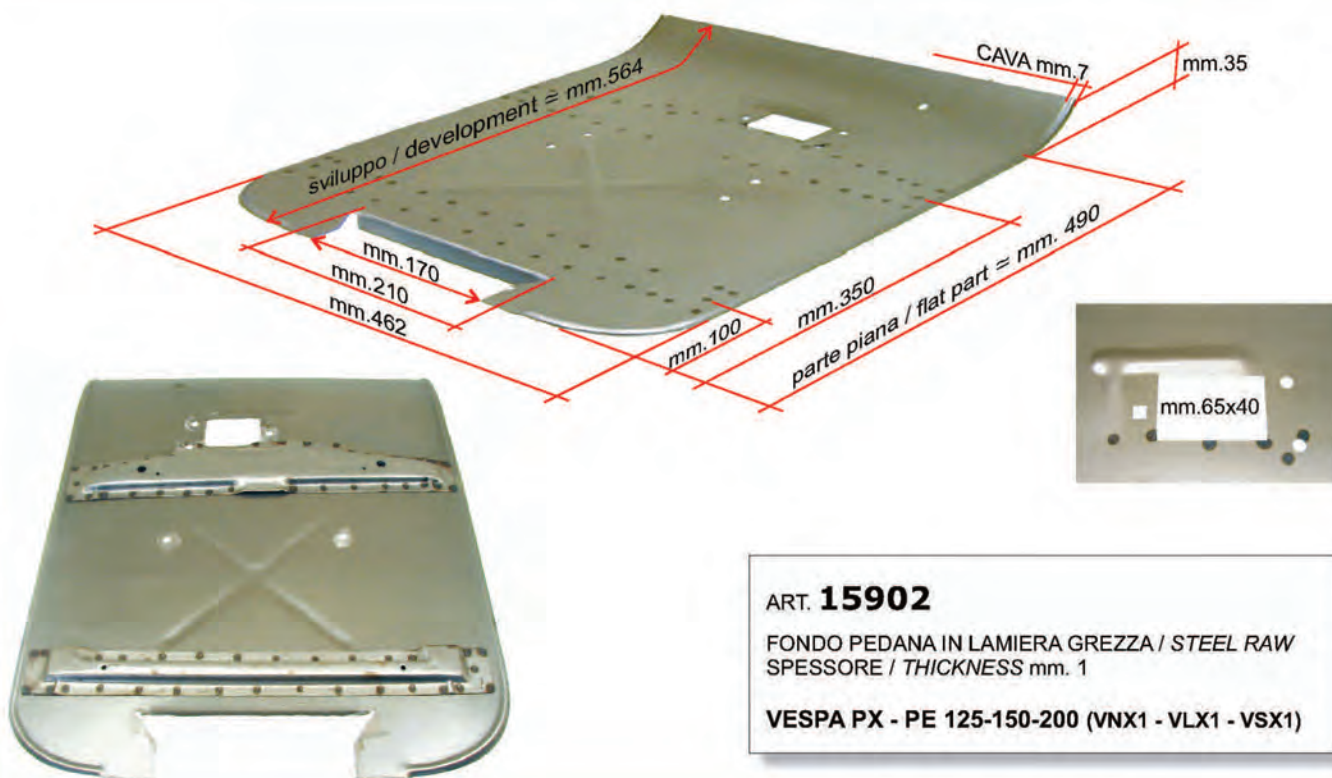
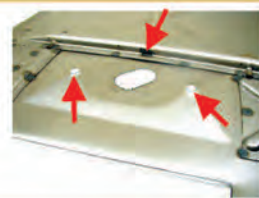

ART. **15902**

FONDO PEDANA IN LAMIERA GREZZA / STEEL RAW
SPESSORE / THICKNESS mm. 1

VESPA PX - PE 125-150-200 (VNX1 - VLX1 - VSX1)



FONDI PEDANA
FLOOR BOARD

LAMIERA GREZZA
STEEL RAW

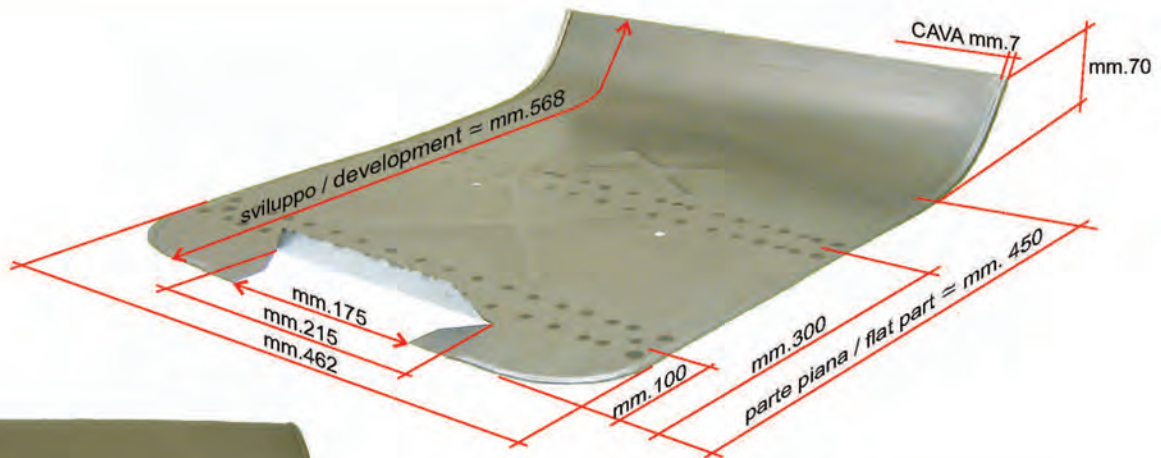

ART. **15904**

FONDO PEDANA IN LAMIERA GREZZA / STEEL RAW
SPESSORE / THICKNESS mm. 1

(2 TRAVERSE / CROSSBEAM)

VESPA GT 125 (VNL2) - TS 125 (VNL3)
VESPA SPRINT 150 (VLB1) - SPRINT VELOCE (VLB2)
VESPA RALLY 180-200 (VSD1) (VSE1)

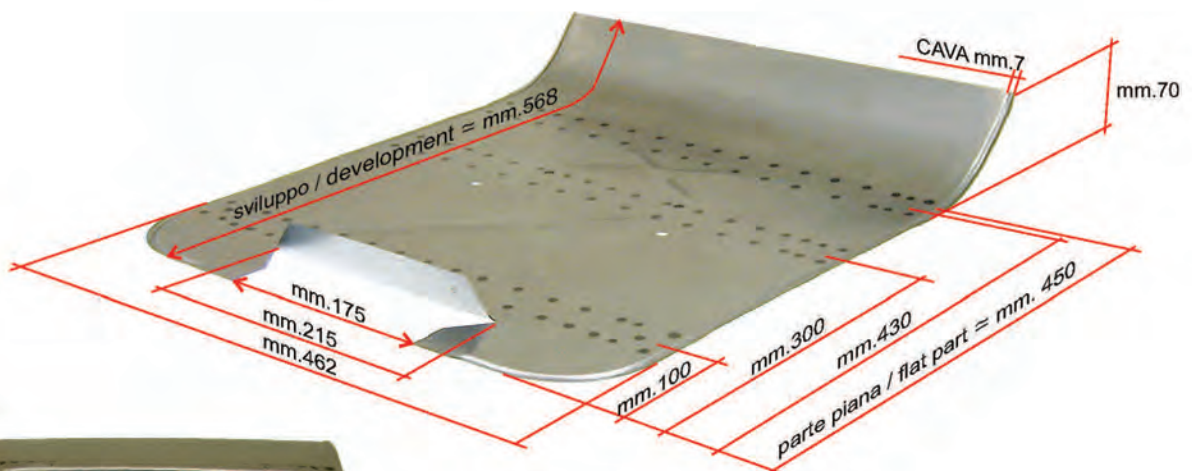

ART. **15906**

FONDO PEDANA IN LAMIERA GREZZA / STEEL RAW
SPESSORE / THICKNESS mm. 1

(3 TRAVERSE / CROSSBEAM)

VESPA 125 (VNC1) - GT 125 (VNL2) - VESPA GL 150 (VLA1)
VESPA SPRINT 150 (VLB1) - SUPER 150 (VBC1)
VESPA 180 SS (VSC1) - RALLY 180 (VSD1)

LAMIERA GREZZA
STEEL RAW

FONDI PEDANA
FLOOR BOARD

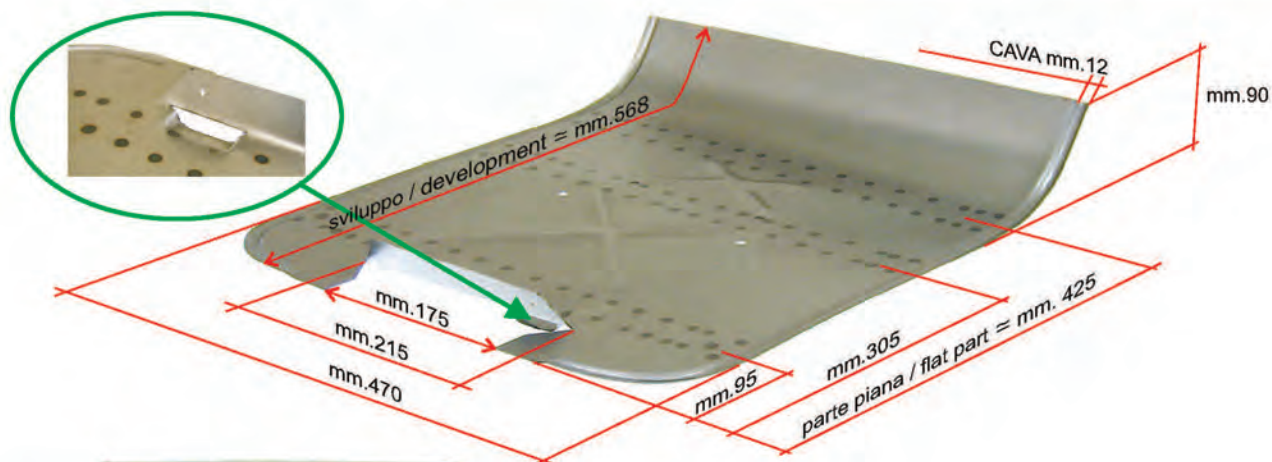

ART. 15908

FONDO PEDANA IN LAMIERA GREZZA / STEEL RAW
SPESSORE / THICKNESS mm. 1

VESPA 125 (VNA-VNB1) - 125 (VBA1)
VESPA 150 (VBA1) - 150 (VBB1) - 150 (VBB2)

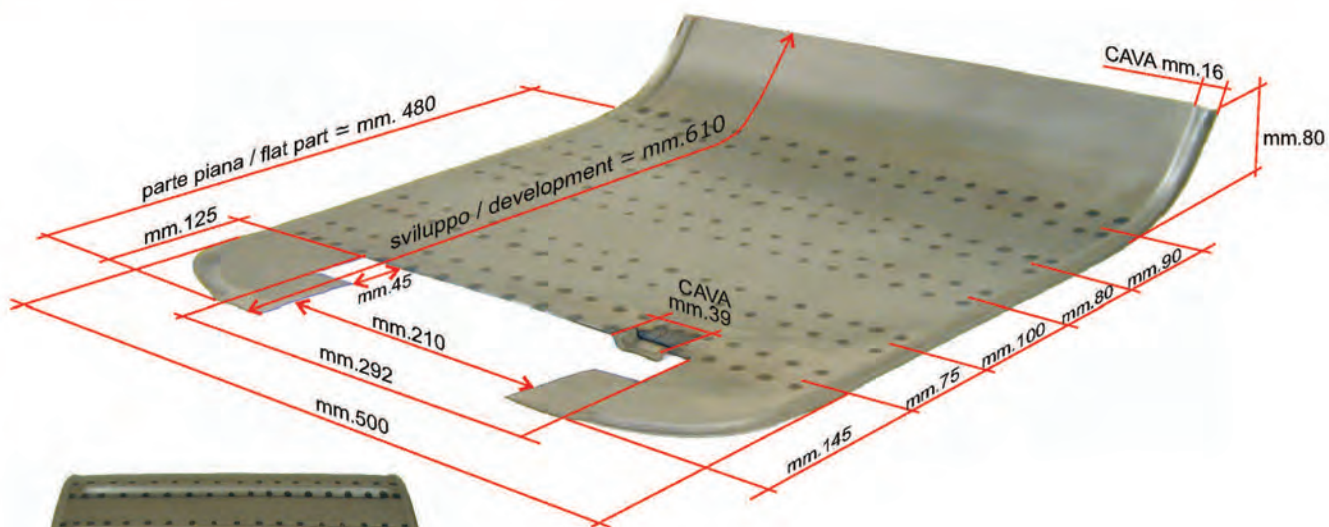

ART. 15910

FONDO PEDANA IN LAMIERA GREZZA / STEEL RAW
SPESSORE / THICKNESS mm. 1

VESPA 125 (V31/33 - VU1 - VN1/2 VM1/2)
VESPA 150 (VL1/2)



SERIE STRISCIE PEDANA

FOOTBOARD STRIPS



VESPA 50 (V5A1T) - VESPA 90 (V9A1T)



N.2 pz. lunghezza / lenght cm. 24
N.1 pz. lunghezza / lenght cm. 48
N.1 pz. lunghezza / lenght cm. 52
N.2 pz. lunghezza / lenght cm. 60

ART. 5370-G

SERIE LISTELLI PEDANA IN GOMMA
RUBBER FOOTBOARD STRIPS SET

VESPA 50 (V5A1T) - VESPA 90 (V9A1T)

(Sim. 610284M)

ALLUMINIO TENERO
SOFT ALUMINIUM

SERIE STRISCIE PEDANA
FOOTBOARDS STRIPS

VESPA 50 - 90 - 125 PRIMAVERA - ET3



ART. 5370

SERIE STRISCIE COMPLETA
COMPLETE SET

VESPA 50 - 90 - 125 PRIMAVERA - ET3
(Sim. 154668)



mm.14



ART. 5375

PROFILATO IN GOMMA PER 1 SERIE STRISCIE PEDANA
RUBBER PROFILE FOR 1 FOOTBOARD STRIPS SET



ART. C00157

KIT PUNTALINI IN ALLUMINIO + RIBATTINI IN ALLUMINIO
PER 1 SERIE STRISCIE PEDANA

ALUMINIUM TERMINAL PADS + ALUMINIUM RIVETS, SET
FOR 1 FOOTBOARD STRIPS SET

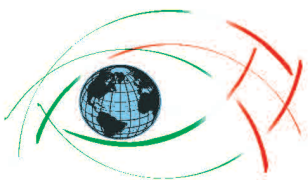

SERIE STRISCIE PEDANA
FOOTBOARD STRIPS

ALLUMINIO TENERO
SOFT ALUMINIUM

VESPA 50 - 90 - 125 PRIMAVERA - ET3

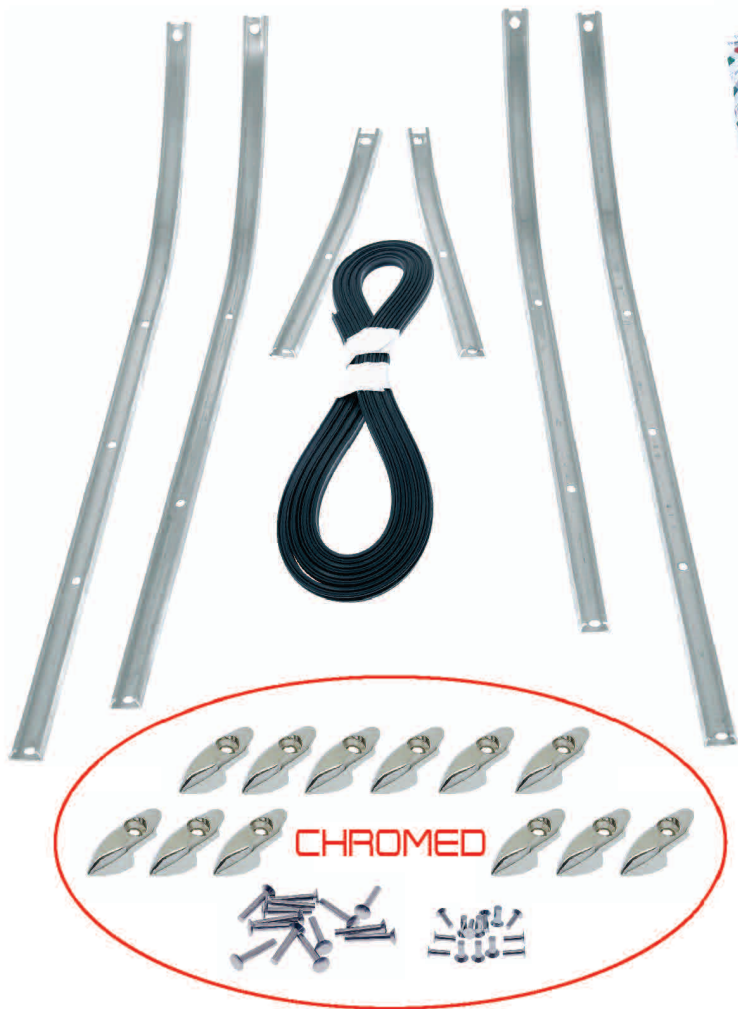

ART. **5370-HQ**

SERIE STRISCE COMPLETA **HIGH QUALITY**
CON PUNTALINI CROMATI

HIGH QUALITY COMPLETE SET
WITH **CHROMED TERMINAL PADS**

VESPA 50 - 90 - 125 PRIMAVERA - ET3

(Sim. 154668)



ART. **5375**

PROFILATO IN GOMMA PER 1 SERIE STRISCE PEDANA

RUBBER PROFILE FOR 1 FOOTBOARD STRIPS SET



ART. **C00157-HQ**

KIT **PUNTALINI CROMATI** + RIBATTINI IN ALLUMINIO
PER 1 SERIE STRISCE PEDANA

CHROMED TERMINAL PADS + ALUMINIUM RIVETS, SET
FOR 1 FOOTBOARD STRIPS SET

ALLUMINIO TENERO
SOFT ALUMINIUM

SERIE STRISCIE PEDANA
FOOTBOARDS STRIPS

VESPA PK 50 - 125



ART. **6145**

SERIE STRISCE COMPLETA CON PUNTALINI
COMPLETE SET WITH TERMINAL PADS

VESPA PK 50 - 125

(Sim. 154669)





SERIE STRISCIE PEDANA
FOOTBOARD STRIPS

ALLUMINIO TENERO
SOFT ALUMINIUM

VESPA PX PE TUTTI MODELLI / ALL MODELS

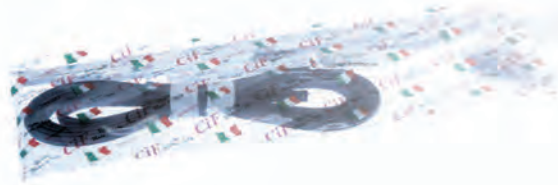

ART. 5371

SERIE STRISCE COMPLETA
CON TUTTI I PUNTALINI FORATI
" FACILE MONTAGGIO "

COMPLETE SET
WITH ALL HOLES TERMINAL PADS
" EASY ASSEMBLY "

UNIVERSALE / UNIVERSAL FOR
VESPA PX PE TUTTE - ALL MODELS

(Sim. 154670)



ART. 5376

PROFILATO IN GOMMA PER 1 SERIE STRISCE PEDANA
RUBBER PROFILE FOR 1 FOOTBOARD STRIPS SET



ART. C00158

KIT PUNTALINI E RIBATTINI
PER 1 SERIE STRISCIE PEDANA

TERMINAL PADS + ALUMINIUM RIVETS, SET
FOR 1 FOOTBOARD STRIPS SET

ALLUMINIO TENERO
SOFT ALUMINIUM

SERIE STRISCIE PEDANA
FOOTBOARDS STRIPS

VESPA PX PE FINO AL / TILL TO 1983 + VESPA LML



ART. 5368

SERIE STRISCE COMPLETA
COMPLETE SET

CON PUNTALINI ANTERIORI CECHI
WITH FRONT TERMINAL PADS WITHOUT HOLES

PUNTALINI POSTERIORI FORATI
REAR TERMINAL PADS WITH HOLE



COME IN ORIGINE PER / AS IN ORIGIN FOR:

VEICOLI FINO AL / VEHICLES TILL TO 1983
P125X - P150X - P200E - PX 125E - PX150E - PX 200E
+ VESPE LML



ART. 5376

PROFILATO IN GOMMA PER 1 SERIE STRISCE PEDANA
RUBBER PROFILE FOR 1 FOOTBOARD STRIPS SET



ART. C00183

KIT PUNTALINI E RIBATTINI
PER 1 SERIE STRISCE PEDANA

TERMINAL PADS + ALUMINIUM RIVETS, SET
FOR 1 FOOTBOARD STRIPS SET

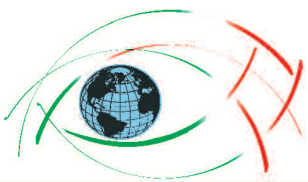

SERIE STRISCIE PEDANA
FOOTBOARD STRIPS

ALLUMINIO TENERO
SOFT ALUMINIUM

VESPA PX PE TUTTI MODELLI / ALL MODELS DAL/SINCE 1983->

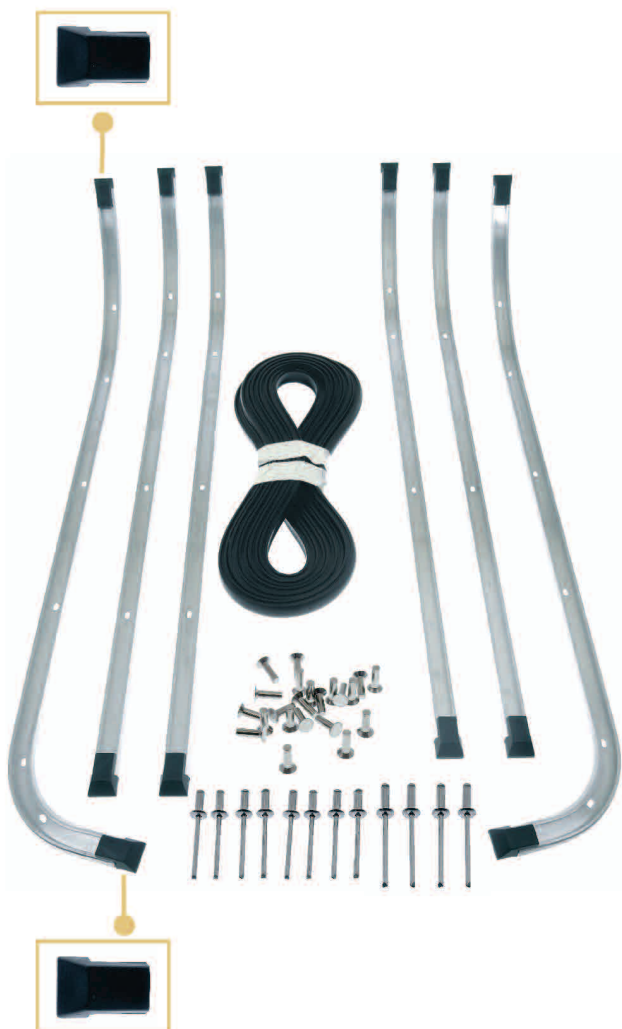

ART. **5369**

SERIE STRISCE COMPLETA
COMPLETE SET

CON PUNTALINI TUTTI CECHI
WITH ALL TERMINAL PADS WITHOUT HOLES



COME IN ORIGINE PER / AS IN ORIGIN FOR:

VESPA PX PE - ARCOBALENO DAL / SINCE 1983

+

VEICOLI FRENO A DISCO / BRAKE DISC VEHICLES:

PX 125-150-200 ('98-'01) - PX 125 EU2 ('01-'07)

PX 30 ANNI 125 ('07-'08) - PX 125 - 150 ('11-'16)



ART. **5376**

PROFILATO IN GOMMA PER 1 SERIE STRISCE PEDANA

RUBBER PROFILE FOR 1 FOOTBOARD STRIPS SET



ART. **C00184**

KIT PUNTALINI E RIBATTINI PER 1 SERIE STRISCE PEDANA

TERMINAL PADS + ALUMINIUM RIVETS, SET
FOR 1 FOOTBOARD STRIPS SET

ALLUMINIO TENERO
SOFT ALUMINIUM

SERIE STRISCIE PEDANA
FOOTBOARDS STRIPS



VESPA SPRINT - RALLY 180/200

ART. **5373**
SERIE STRISCE COMPLETA / COMPLETE SET
VESPA SPRINT - RALLY 180/200



ART. **5376-S**
PROFILATO IN GOMMA PER 1 SERIE STRISCE PEDANA
RUBBER PROFILE FOR 1 FOOTBOARD STRIPS SET



ART. **C00156**
KIT PUNTALINI E RIBATTINI PER 1 SERIE STRISCE PEDANA
TERMINAL PADS + ALUMINIUM RIVETS, SET
FOR 1 FOOTBOARD STRIPS SET



VESPA GL

ART. **5374**
SERIE STRISCE COMPLETA / COMPLETE SET
VESPA GL
ADATTABILE A / SUITABLE TO : VESPA SUPER



ART. **5376-S**
PROFILATO IN GOMMA PER 1 SERIE STRISCE PEDANA
RUBBER PROFILE FOR 1 FOOTBOARD STRIPS SET



ART. **C00156**
KIT PUNTALINI E RIBATTINI PER 1 SERIE STRISCE PEDANA
TERMINAL PADS + ALUMINIUM RIVETS, SET
FOR 1 FOOTBOARD STRIPS SET



SERIE STRISCIE PEDANA
FOOTBOARD STRIPS

ALLUMINIO TENERO
SOFT ALUMINIUM

KIT HIGH QUALITY SPECIFICO / SPECIFIC : VESPA GL 150 (VLA)

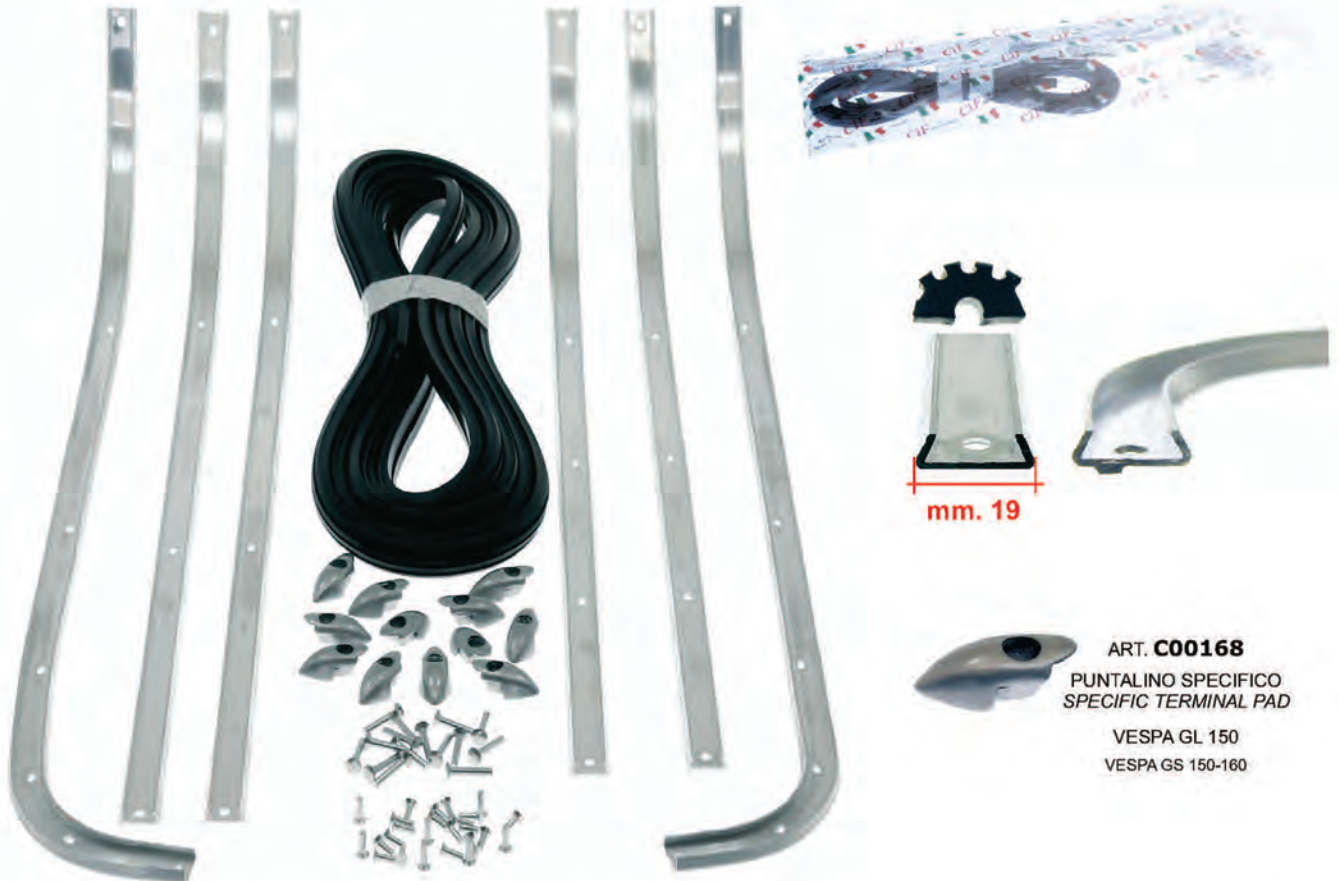

ART. C00168
PUNTALINO SPECIFICO
SPECIFIC TERMINAL PAD
VESPA GL 150
VESPA GS 150-160

ART. 5374-OR

SERIE STRISCE COMPLETA / COMPLETE SET

VESPA GL 150 (VLA)

**LUNGHEZZE, SEZIONE E FORATURE LISTELLI, CONFORMI ALL'ORIGINALE
GOMMA LARGA E PUNTALINI COME ORIGINALI**

ALL CONFORM (MEASURES-DRILLING AND WIDE STRIP) TO THE ORIGINAL VERSION



ART. C00377-8

PROFILATO IN GOMMA PER 1 SERIE STRISCE PEDANA
RUBBER PROFILE FOR 1 FOOTBOARD STRIPS SET



ART. C00174-OR

KIT PUNTALINI E RIBATTINI PER 1 SERIE STRISCE PEDANA
TERMINAL PADS + ALUMINIUM RIVETS, SET
FOR 1 FOOTBOARD STRIPS SET

ALLUMINIO TENERO
SOFT ALUMINIUM

SERIE STRISCIE PEDANA
FOOTBOARDS STRIPS

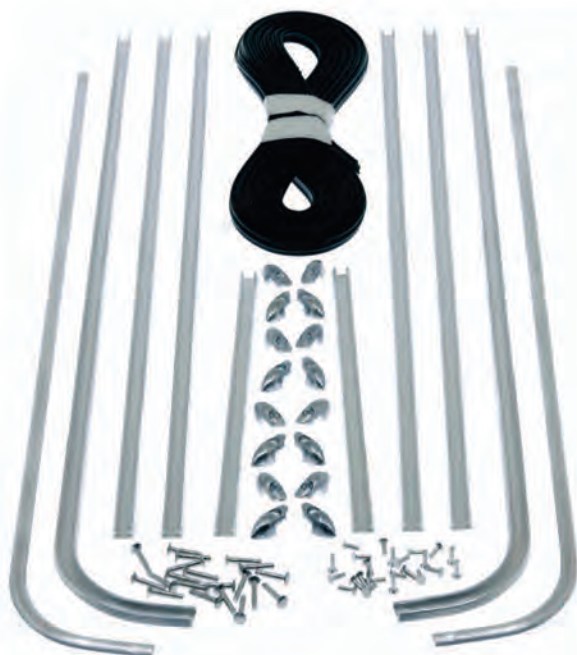

VESPA 125 (VNB1-2) ('59-'61)
VESPA 125 (VNA 1-2) ('58-'59)

ART. 5372-KB

SERIE BASE COMPLETA

(Nr.8 pz. +2 SOTTOLISTELLI + PUNTALINI E RIBATTINI)

BASIC COMPLETE SET

(No.8 pcs.+2 UNDER RETAINERS STRIP+TERMINAL PADS+RIVETS)

VESPA 125 (VNB1-2) ('59-'61) - VESPA 125 (VNA 1-2) ('58-'59)



ART. C00372

PROFILATO IN GOMMA PER 1 SERIE STRISCIE PEDANA
RUBBER PROFILE FOR 1 FOOTBOARD STRIPS SET

ART. C00167

KIT PUNTALINI E RIBATTINI PER 1 SERIE STRISCIE PEDANA
PACKING OF TERMINAL PADS + ALUMINIUM RIVETS
FOR 1 FOOTBOARD STRIPS SET

VESPA 125 (VNB3-4-5-6) ('58-'66)
VESPA 150 (VBB2) ('63-'65)

ART. 5372.01

SERIE STRISCE COMPLETA

(NR.6 pz. +2 SOTTOLISTELLI + PUNTALINI + RIBATTINI)

COMPLETE SET

(No. 6 pcs.+2 UNDER RETAINERS STRIP+TERMINAL PADS+RIVETS)

SPECIFICA PER / SPECIFIC FOR:

VESPA 125 (VNB3-4-5-6) ('58-'66) - VESPA 150 (VBB2) ('63-'65)



ART. C00372.01

PROFILATO IN GOMMA PER 1 SERIE STRISCIE PEDANA
RUBBER PROFILE FOR 1 FOOTBOARD STRIPS SET

ART. C00182

KIT PUNTALINI E RIBATTINI PER 1 SERIE STRISCIE PEDANA
TERMINAL PADS + ALUMINIUM RIVETS, SET
FOR 1 FOOTBOARD STRIPS SET



SERIE STRISCIE PEDANA
FOOTBOARD STRIPS

ALLUMINIO TENERO
SOFT ALUMINIUM

VESPE FARO BASSO



ART. 5377-K

SERIE STRISCE COMPLETA

(Nr.9 pz. + 2 SOTTOLISTELLI + PUNTALINI SPECIFICI + RIBATTINI + VITI)

COMPLETE SET

(No. 9 pcs.+2 UNDER RETAINERS STRIP + SPECIFIC TERMINAL PADS+ RIVETS + SCREWS)

SPECIFICA PER / SPECIFIC FOR:
VESPA 125 VM1 ('53)-VM2 ('54)

*** ADATTABILE A MODELLI / SUITABLE TO MODELS:**
VESPA VN1 ('54-'55) - VN2 ('56-'57)
VEDI INDICAZIONI SOTTO RIPORTATE
LOOK AT THE INSTRUCTIONS BELOW



mm. 19



ART. C00377-8

PROFILATO IN GOMMA PER 1 SERIE STRISCE PEDANA
RUBBER PROFILE FOR 1 FOOTBOARD STRIPS SET)



ART. C00187

KIT PUNTALINI PER 1 SERIE STRISCE PEDANA
TERMINAL PADS SET FOR 1 FOOTBOARD STRIPS SET



ART. C00154

KIT RIBATTINI IN ALLUMINIO+ VITI PER 1 SR.STRISCE PEDANA
ALUMINIUM RIVETS + SCREWS FOR 1 FOOTBOARD STRIPS SET

*** LE MODIFICHE D'APPORTARE PER L'UTILIZZO DELLA SERIE ART. 5377-K SU VEICOLI**
VESPA 125 VN1 - VN2 SONO LE SEGUENTI:

FOR TO USE ON **VESPA 125 VN1 - VN2** MUST BE CHANGE THE KIT 5377-K AS FOLLOW:

- Listello **A** : accorciare circa 20 mm., (portare a 540 mm.)
- Listello **B** : accorciare circa 145 mm., (portare a 435 mm)
- Listello **C** : non va utilizzato
- Listello **D** : mantenere la misura
- Listello **E** : accorciare circa 115 mm., (portare a 350 mm.)

- cut about 20 mm. for to have 540 mm.
- cut about 145 mm. for to have 435 mm.
- do not use
- maintain the original size
- cut about 115 mm. for to have 350 mm.

ALLUMINIO TENERO
SOFT ALUMINIUM

SERIE STRISCIE PEDANA
FOOTBOARDS STRIPS

VESPA GS 150 (VS2->VS5) ('56-'61)



ART. 5378-K

SERIE STRISCE COMPLETA

(Nr.9 pz. +2 SOTTOLISTELLI +
PUNTALINI SPECIFICI + RIBATTINI + VITI)

COMPLETE SET

(No. 9 pcs. + 2 UNDER RETAINERS STRIP +
SPECIFIC TERMINAL PADS + RIVETS + SCREWS)

VESPA GS 150 dal VS2 al VS5 ('56->'61)



mm. 19



ART. C00377-8

PROFILATO IN GOMMA PER 1 SERIE STRISCE PEDANA

RUBBER PROFILE FOR 1 FOOTBOARD STRIPS SET



ART. C00154

KIT RIBATTINI IN ALLUMINIO+ VITI PER 1 SR.STRISCE PEDANA

**ALUMINIUM RIVETS + SCREWS, SET
FOR 1 FOOTBOARD STRIPS SET**



ART. C00188

KIT PUNTALINI PER 1 SERIE STRISCE PEDANA

TERMINAL PADS FOR 1 FOOTBOARD STRIPS SET



PROFILATO STRISCIE PEDANA

FOOTBOARD STRIPS PROFILE



ART. 5375

PROFILATO IN GOMMA (cm.280 lordi/gross)
PER 1 SERIE STRISCIE PEDANA

RUBBER PROFILE FOR 1 FOOTBOARD STRIPS SET

VESPA 50 - 90 - 125 PRIMAVERA-ET3

(Sim.047243)



ART. 5376

PROFILATO IN GOMMA (cm.400 lordi/gross)
PER 1 SERIE STRISCIE PEDANA

RUBBER PROFILE FOR 1 FOOTBOARD STRIPS SET

VESPA PX PE - ARCOBALENO - PK

(Sim.154778- 154829)



ART. 5376-S

PROFILATO IN GOMMA (cm.375 lordi/gross)
PER 1 SERIE STRISCIE PEDANA

RUBBER PROFILE FOR 1 FOOTBOARD STRIPS SET

VESPA SPRINT

(Sim.154776)



ART. C00377-8

PROFILATO IN GOMMA (cm.390 lordi/gross)
PER 1 SERIE STRISCIE PEDANA

RUBBER PROFILE FOR 1 FOOTBOARD STRIPS SET

VESPA 125 (VN1-2 - VM1-2) - VESPA GL 150 (VLA)
VESPA GS 150 (dal VS2 al VS5) ('56->'61)

(Sim.018468)



ART. C00372

PROFILATO IN GOMMA (cm.420 lordi/gross)
PER 1 SERIE STRISCIE PEDANA

RUBBER PROFILE FOR 1 FOOTBOARD STRIPS SET

VESPA 125 (VNB1-2 '59-'61) - (VNA 1-2 '58-'59)

ART. C00372.01

PROFILATO IN GOMMA (cm.380 lordi/gross)
PER 1 SERIE STRISCIE PEDANA

RUBBER PROFILE FOR 1 FOOTBOARD STRIPS SET

VESPA 125 (VNB3-4-5-6) ('58-'66)
VESPA 150 (VBB2) ('63-'65)

PUNTALINI STRISCIE PEDANA

FOOTBOARDS STRIPS TERMINAL PADS



ART. **C00160-HQ**

PUNTALINO **CROMATO HIGH QUALITY**
PER SERIE STRISCIE PEDANA

(Sim.98668)

HIGH QUALITY CHROMED TERMINAL PAD, FOR FOOTBOARD STRIPS

VESPA 50 - 90 125 PRIMAVERA - ET3



ART. **C00160**

PUNTALINO PER SERIE STRISCIE PEDANA

(Sim.98668)

TERMINAL PAD FOR FOOTBOARD STRIPS

VESPA 50 - 90 125 PRIMAVERA ET3



ART. **C00160-SHQ**

PUNTALINO **CROMATO HIGH QUALITY**
PER SERIE STRISCIE PEDANA

(Sim.73405)

HIGH QUALITY CHROMED TERMINAL PAD, FOR FOOTBOARD STRIPS

VESPA SPRINT - RALLY

VESPA GL (SERIE CON LISTELLO mm. 18 / SERIES WITH STRIP mm.18)



ART. **C00160-S**

PUNTALINO PER SERIE STRISCIE PEDANA
TERMINAL PAD FOR FOOTBOARD STRIPS

(Sim.73405)

VESPA SPRINT - RALLY

VESPA GL (SERIE CON LISTELLO mm. 18 / SERIES WITH STRIP mm.18)



ART. **C00157-HQ**

KIT PUNTALINI CROMATI + RIBATTINI IN ALLUMINIO
PER 1 SERIE STRISCIE PEDANA

CHROMED TERMINAL PADS + ALUMINIUM RIVETS, SET
FOR 1 FOOTBOARD STRIPS SET

VESPA 50 - 90 125 PRIMAVERA ET3



ART. **C00156-HQ**

KIT PUNTALINI CROMATI + RIBATTINI IN ALLUMINIO
PER 1 SERIE STRISCIE PEDANA

CHROMED TERMINAL PADS + ALUMINIUM RIVETS, SET
FOR 1 FOOTBOARD STRIPS SET

VESPA SPRINT - RALLY

VESPA GL (SERIE CON LISTELLO mm. 18 / SERIES WITH STRIP mm.18)



PUNTALINI STRISCIE PEDANA

FOOTBOARD STRIPS TERMINAL PADS

WITH HOLE



ART. **5888**

PUNTALINO **CON FORO** UNIVERSALE DI FACILE MONTAGGIO (Sim.159828)
PER TUTTE LE SR. STRISCE PEDANA

TERMINAL PAD WITH HOLE, UNIVERSAL EASY ASSEMBLY FOR ALL FOOTBOARD STRIPS

VESPA PX PE

SPECIFICO PER LISTELLI POSTERIORI / SPECIFIC FOR REAR STRIPS:

PER VEICOLI FINO AL / FOR VEHICLES TILL TO 1983:

VESPA P125X - P150X - PX125E - PX150E - P200E - PX200E

VESPE LML

WITHOUT HOLE



ART. **5889**

PUNTALINO **CIECO** / TERMINAL PAD **WITHOUT HOLE**

(Sim.182174)

ESTREMITA' ANTERIORI / FRONT:

PER VEICOLI FINO AL / FOR VEHICLES TILL TO 1983:

VESPA P125X - P150X - PX125E - PX150E - PX200E - P200E + VESPE LML

ESTREMITA' ANTERIORI E POSTERIORI PER / FRONT & REAR:

VESPA PX PE - ARCOBALENO DAL / SINCE 1983

+

VEICOLI FRENO A DISCO / BRAKE DISC VEHICLES :

VESPA PX 125-150-200 ('98-'01) - PX 125 EU2 ('01-'07)

VESPA PX 30 ANNI 125 ('07-'08) - PX 125-150 ('11-16)



ART. **C00168**

PUNTALINO PER SERIE STRISCE PEDANA

TERMINAL PAD FOR FOOTBOARD STRIPS

VESPA GS 150 - 160 - VESPA GL 150 (VLA)



ART. **C00169-CP**

CP. PUNTALINI (DESTRO+SINISTRO) PER LISTELLI ESTERNI

PAIR OF TERMINAL PADS (RIGHT+LEFT) FOR OUTSIDE RETAINERS

VESPA GS 150 VS2T.....



ART. **C00161-I**

PUNTALINO PER LISTELLI INTERNI

TERMINAL PAD FOR INTERNAL RETAINERS

VESPA 125 (VM1 '53) - (VM2 '54) - (VN1 '54-'55) - (VN2 '56-'57)



ART. **C00161-E**

PUNTALINO PER LISTELLI ESTERNI

TERMINAL PAD FOR EXTERNAL RETAINERS

VESPA 125 (VM1 '53) - (VM2 '54) (VN1 '54-'55) - (VN2 '56-'57)

RIBATTINI-VITI STRISCIE PEDANA

FOOTBOARDS STRIPS RIVETS-SCREWS



ART. 5382-C

RIVETTO A STRAPPO CORTO $\varnothing 4 \times 10$ mm.

PER FISSAGGIO PUNTALINI **LISTELLI INTERNI** SR. STRISCIE PEDANA

ALUMINUM TEAR OFF RIVET (SHORT) x FIX INSIDE RETAINERS TERMINAL PADS FOOTBOARD STRIPS

VESPA PX PE - PX ARCOBALENO - PX FRENO A DISCO - VESPE LML



ART. 5382-L

RIVETTO A STRAPPO LUNGO $\varnothing 4 \times 12$ mm.

PER FISSAGGIO PUNTALINI **LISTELLI ESTERNI** SR. STRISCIE PEDANA

ALUMINUM TEAR OFF RIVET (LONG) x FIX OUTSIDE RETAINERS TERMINAL PADS FOOTBOARD STRIPS

VESPA PX PE - PX ARCOBALENO - PX FRENO A DISCO - VESPE LML



ART. 5380

RIBATTINO IN ALLUMINIO $\varnothing 3,5 \times 23$ mm.

PER FISSAGGIO TUTTI TIPI SR. STRISCIE PEDANA

ALUMINIUM RIVET $\varnothing 3,5 \times 23$ mm.
FOR FIX ALL TYPE OF FOOTBOARD STRIPS



ART. 5380-CO

RIBATTINO IN ALLUMINIO $\varnothing 3 \times 10$ mm. - (LUNGHEZZA COMPLESSIVA mm.10)

PER FISSAGGIO TUTTI TIPI SR. STRISCIE PEDANA

ALUMINIUM RIVET $\varnothing 3 \times 10$ mm. - (TOTAL LENGHT mm.10)
FOR FIX ALL TYPE OF FOOTBOARD STRIPS



ART. 5381

VITE TESTA CACCIAVITE BOMBATA SOPRA - SVASATA SOTTO TESTA - mm. **3,5x22**
AUTOFILETTANTE INOX

PER SR. STRISCIE PEDANA CIF ART. 5377-K e 5378-K

INOX SELF-TAPPING SCREW, mm.3,5x22 FOR FOOTBOARD STRIPS
CIF ART. 5377-K and 5378-K

VESPA 125 VM1 ('53) - VM2 ('54) - VN1 ('54-'55) - VN2 ('56-'57)

VESPA GS 150 dal VS2 al VS5 ('56->'61)



ART. 5381-CO

VITE TESTA CACCIAVITE BOMBATA SOPRA - SVASATA SOTTO TESTA - mm. **4,2x16**
AUTOFILETTANTE INOX

GENERICA

INOX SELF-TAPPING SCREW, mm.4,2x16 - GENERIC



TAPPETI IN GOMMA

RUBBER MATS



SPECIFICO / SPECIFIC: **VESPA 50**

ART. **7435**
NERO / BLACK

ART. **7435-G**
GRIGIO / GREY



VESPA - 90 - 125 PRIMAVERA - ET3

ART. **7420**
NERO / BLACK

VESPA PK 50 - PK 125



ART. **7421**
NERO / BLACK

VESPA PK 50 XL - PK 125 XL



ART. **7422**
NERO / BLACK

VESPA PX PE - PX PE SERIE ARCOBALENO



ART. **7424**
NERO / BLACK

VESPA 125 T5



ART. **7425**
NERO / BLACK

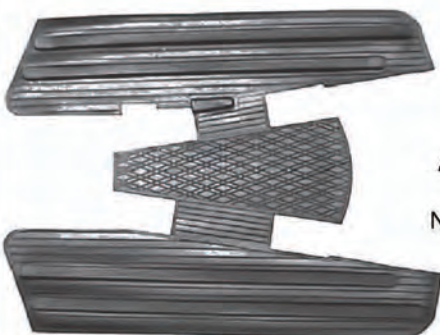

VESPA SPRINT

ART. **7426**
NERO / BLACK

ART. **7426-G**
GRIGIO / GREY



TAPPETINI CENTRALI

CENTRAL MATS



ART. **7427**

TAPPETINO IN GOMMA
NERO

VESPA 125 PRIMAVERA ET3



ART. **7427-LI**

CP. LISTELLI INOX

COMPLETA DI 6 VITI TESTA CACCIAVITE



ART. **7427-KT**

KIT COMPOSTO DA:
TAPPETO + CP. LISTELLI INOX + 6 VITI TESTA
CACCIAVITE

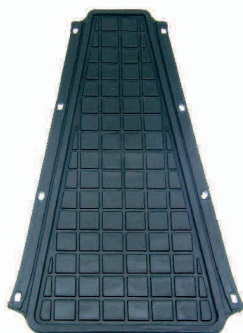

ART. **7428**

TAPPETINO IN GOMMA
NERO

VESPA PX 1ª SERIE



ART. **7428-LI**

CP. LISTELLI INOX (Sim.610296M)

COMPLETA DI 8 VITI TESTA CROCE SVASATA



ART. **7428-KT**

KIT COMPOSTO DA:
TAPPETO + CP. LISTELLI INOX +
8 VITI TESTA CROCE SVASATA



ART. **7429**

TAPPETINO IN GOMMA
NERO

VESPA 150 dal 1959 - VESPA 125 dal 1962 GS 160 dal 1962 al 1964 SPRINT - SUPER - GTR - RALLY

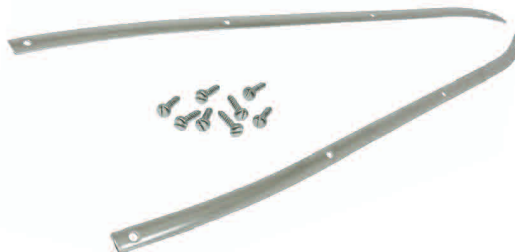

ART. **7429-LI**

CP. LISTELLI INOX (Sim.610295M)

COMPLETA DI NR. 8 VITI TESTA CACCIAVITE



ART. **7429-KT**

KIT COMPOSTO DA:
TAPPETO + CP. LISTELLI INOX +
8 VITI TESTA CACCIAVITE



ART. **5277**

VITE TESTA CROCE SVASATA
mm. 2,9x13
APPLICAZIONI VARIE



ART. **5277-TCA**

VITE TESTA TAGLIO CACCIAVITE
mm. 2,9x13
APPLICAZIONI VARIE



TAPPETI-PEDANE APPOGGIAPIEDI

CENTRAL MATS - FOOTBOARDS



ART. 6196

COPPIA TAPPETI IN GOMMA

RUBBER MAT PAIR

VESPA PK - XL - RUSH - N - FL2

(Sim. 498463)



ART. 6195

PEDANA CENTRALE APPOGGIAPIEDI (COLORE NERO)

CENTRAL FOOTBOARD (BLACK COLOUR)

VESPA 125 T5

(Sim. 226093)



ART. 6195-A

PEDANA CENTRALE APPOGGIAPIEDI (COLORE GRIGIO)

CENTRAL FOOTBOARD (GREY COLOUR)

VESPA PX PE ARCOBALENO

(Sim. 219109)



ART. 6194

PEDANA CENTRALE APPOGGIAPIEDI (COLORE GRIGIO)

CENTRAL FOOTBOARD (GREY COLOUR)

VESPA PK 50-125 - PK XL 50-125 - RUSH 50

(Sim. 253014)

PARTI IN GOMMA

RUBBER PARTS



ART. **G0815** PASSACAVO COMANDO FRIZIONE (Sim. 070219)
 FRAME GROMMET
 VESPA 50 - 90 - 125 PRIMAVERA - ET3



ART. **G0607** PASSACAVO COMANDO GAS (Sim. 048171)
 GROMMET
 VESPA PX PE 125 - 150 - 200



ART. **G0610** PASSACAVO CAVI COMANDO (Sim. 241071)
 GROMMET
 VESPA PK - PK XL - FL - FL2 - N - HP



ART. **G0675** PASSACAVO TUBO BENZINA AL TELAIO (Sim. 84262)
 GROMMET
 VESPA 125 (VNA1T-2T) (VNB1T->6T) - SUPER (VNC1T)
 SUPER 150 (VBC1T) - GT (VNL2T) - GTR (VNL2T) - TS (VNL3T)
 VESPA 150 (VBA1T) - (VBB1T->2T) SPRINT (VLB1T)
 SPRINT VELOCE - GS 160 (VSB1T) - 180 SS (VSC1T)
 RALLY 180-200 (VSD1T-VSE1T) - PX - PE - PX ARCOBALENO

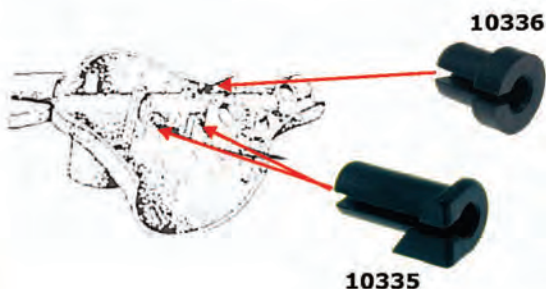

ART. **10336** TERMINALE PASSACAVO (Sim. 139912)
 (situato parte interna coprimanubrio)
 END GROMMET
 (positioned inside handlebar cover)
 VESPA N 50 - PK 50 - PK AUTOMATICA 50
 PK XL 50/125 - PK XL PLURIMATIC 50
 PK RUSH 50 - PX 125-150 - PX 30 ANNI 125
 PX EU2 125 - PXE ARCOBALENO 125 - T5 125

ART. **10335** TERMINALE PASSACAVO (Sim. 139913)
 (situato parte interna coprimanubrio)
 END GROMMET
 (positioned inside handlebar cover)
 VESPA N 50 - PK 50 - PK AUTOMATICA 50
 PK XL 50/125 - PK XL PLURIMATIC 50
 PK RUSH 50 - PX 125-150 - PX 30 ANNI 125
 PX EU2 125 - PXE ARCOBALENO 125 - T5 125



ART. **7128** GOMMINO PROTEZIONE (Sim. 057321)
 CAVO FRENO POSTERIORE
 RUBBER REAR BRAKE CABLE PROTECTION
 VESPA

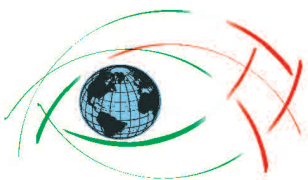

PARTI IN GOMMA

RUBBER PARTS



ART. **G0605** GOMMINO PASSACAVI (Sim. 46766)
STATORE VOLANO MAGNETE
GROMMET STATOR FLYWHEEL MAGNET
VESPA 50 ('67-'82) - 125 ('55-'65) - PK 50 ('82-'84)
APE P 50 ('80-'85) - TM P 50 ('85-'89)



ART. **7398** TASSELLO FERITOIA VOLANO MAGNETE (Sim. 110162)
(TIPO GRANDE)
FLYWHEEL RUBBER PLUG (**BIG TYPE**)
VESPA 50



ART. **7399** TASSELLO FERITOIA VOLANO MAGNETE (Sim. 110856)
(TIPO PICCOLO)
FLYWHEEL RUBBER PLUG (**SMALL TYPE**)
VESPA 125 ET3 - PX PE



ART. **G0822** CAPPUCCIO BASSA TENSIONE (Sim. 161125)
CAP LOW VOLTAGE
VESPA 50 - 90 - 125
APE 50



ART. **7123-K** TRIS CAPPUCCI ELETTRICI
ELECTRICAL PROTECTION SET
VESPA GS 160
VESPA 180 SS



ART. **7120** CAPPUCCIO PROTEZIONE BOBINA (Sim. 048525)
COOIL PROTECTION HOOD
VESPA 150 (VBBA1T - VBB12T)
VESPA GL 150 (VLA1T)
VESPA RALLY 180 (VSD1T)



ART. **7122** CAPPUCCIO BOBINA ALTA TENSIONE (Sim. 022694)
COOIL PROTECTION HOOD
VESPA 150 (VL1/2/3) - (VB1) - (GL1)
VESPA GS 150 (VS1->VS5)

PARTI IN GOMMA

RUBBER PARTS



ART. **G0659** CAPPuccio CANDELA (Sim. 46741)
 SPARK PLUG CAP
 VESPA 125 - P125X - 150 - P150X
 VESPA PX PE ARCOBALENO



ART. **G0849** CAPPuccio CANDELA (S.244395-72843)
 SPARK PLUG CAP
 VESPA 50 - 90 - 125 PRIMAVERA - ET3
 VESPA PK-PK XL - RUSH - FL - FL2 HP
 VESPA PX 125 - PX EU2 125 - COSA CL-CLX
 APE 50 - FL/FL2 50 - MIX 2T 50 - P50
 APE RST MIX 50 - TM P 50



ART. **5709** TUBETTO PROTEZIONE AGGANGI (Sim. 024041)
 COFANI LATERALI
 PROTECTION TUBE FOR COWLS
 VESPA PX PE 125-150-200



ART. **5708** TAMPONE RICONTRO COFANO (DESTRO E SINISTRO)
 (DESTRO E SINISTRO)
 BUFFER FOR COWL (RIGHT AND LEFT)
 VESPA PX



ART. **5710** GOMMINO PER BATTUTA COFANO/SPORTELLLO MOTORE (Sim. 232222)
 BUFFER FOR
 ENGINE COWLS, SIDEPANELS
 VESPA 50 - 90 - 125 PRIMAVERA - ET3



ART. **5707** TAMPONE PARACOLPI CAVALLETTO (Sim.174773)
 CENTRAL STAND BUFFER



ART. **1930** GOMMINO BATTUTA COFANO DESTRO (Sim.018946)
 RIGHT HOOD RUBBER STOP
 VESPA 125 (VM1/2T '53>'54 - VN1/2T '54>'57)
 VESPA 150 (VL1/2/3T '55>'56 - VB1T '57>'58)



PARTI IN GOMMA

RUBBER PARTS



ART. 5680

SUPPORTO ELASTICO PER AMMORTIZZATORI POSTERIORI
REAR SHOCK ABSORBERS BUFFER

(Sim. 60536)

VESPA TUTTI TIPI / ALL MODELS

ART. 5684

SUPPORTO ELASTICO INFERIORE
attacco ammortizzatore
posteriore al motore
lower buffer for fix rear shockabsorber at engine
(Sim.157103-040316)



VESPA 50S - 50R - 50 SPECIAL
VESPA 90 - 125 PRIMAVERA - ET3 125
VESPA FL 50/125 - FL2 AUTOMATICA 50
VESPA FL2 HP 50 - N 50
VESPA PK TUTTI MODELLI/ALL MODELS
VESPA PX 125 - PX EU2 125
VESPA PXE ARCOBALENO 125 - T5 125
VESPA GS - SUPER SPORT 150 - GT 125
VESPA SPRINT - GR - SUPER - RALLY 200
VESPA TS 125
VESPA COSA 2 125 - COSA CL-CLX 125
APE CALESSINO (CITY) 200-CALESSINO-VME 420
APE CALESSINO E4 200 - CAR - MAX DIESEL 420
APE CAR P2-P3 220 - CLASSIC E4 400
APE MP P501-P601 220
POKER BENZINA 420 - POKER DIESEL 420

ART. 5684-KT

KIT SUPPORTO ELASTICO
INFERIORE + BUSSOLA IN FERRO
attacco ammortizzatore
posteriore al motore
lower buffer + iron bush KIT
for fix rear shockabsorber at engine



ART. 6480

TAMPONE DI RISCONTRO
(SUPERIORE)
PER AMMORTIZZATORE ANTERIORE
UPPER BUFFER
FOR FRONT SHOCK ABSORBER
(Sim. 057012)

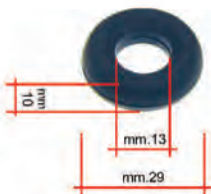

DIMENSIONI / DIMENSIONS:
Ø INTERNO / INSIDE mm. 13
Ø ESTERNO / OUTSIDE mm. 29
SPESSORE / THICKNESS mm. 10

VESPA 50 - 90 - 125 PRIMAVERA - ET3
VESPA PK 50 -125 E DERIVATE

ART. 6482

TAMPONE DI RISCONTRO
(SUPERIORE)
PER AMMORTIZZATORE ANTERIORE
UPPER BUFFER
FOR FRONT SHOCK ABSORBER
(Sim. 174085)



DIMENSIONI / DIMENSIONS:
Ø INTERNO / INSIDE mm. 16
Ø ESTERNO / OUTSIDE mm. 33
SPESSORE / THICKNESS mm. 10

VESPA PX PE E DERIVATE

ART. 6485

TAMPONE DI RISCONTRO
(SUPERIORE)
PER AMMORTIZZATORE POSTERIORE
UPPER BUFFER
FOR REAR SHOCK ABSORBER
(Sim. 178150)

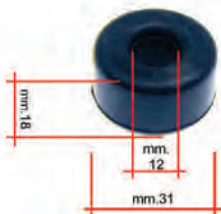

DIMENSIONI / DIMENSIONS:
Ø INTERNO / INSIDE mm. 12
Ø ESTERNO / OUTSIDE mm. 31
SPESSORE / THICKNESS mm. 18

VESPA PK 50/125 E DERIVATE
SCOOTER PIAGGIO GILERA

ART. 6486

TAMPONE DI RISCONTRO
(INFERIORE)
PER AMMORTIZZATORE POSTERIORE
LOWER BUFFER
FOR REAR SHOCK ABSORBER
(Sim. 178149)



DIMENSIONI / DIMENSIONS:
Ø INTERNO / INSIDE mm. 13
Ø ESTERNO / OUTSIDE mm. 38
SPESSORE / THICKNESS mm. 21

VESPA 50 - 90 - 125 PRIMAVERA - ET3
VESPA PK 50/125

PARTI IN GOMMA

RUBBER PARTS

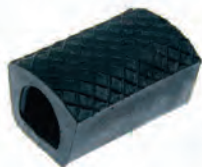

ART. **G0678** GOMMINO PROTEZIONE LEVA FRENO (Sim. 93100)

BRAKE PEDAL GROMMET

VESPA 125 (VNB3/4/5/6T '61-'66) - 150 (VBB1/2T '61-'66)
VESPA SUPER 125 ('66-'68) - SUPER 150 ('66-'79)
VESPA GRAN TURISMO (VNL1T dal telaio 30001 '66-'73)
VESPA GL 150 - GS 150 - GS 160 - 180 SS - RALLY 180-200



ART. **G0825** GOMMINO PROTEZIONE LEVA FRENO (Sim.100426)

BRAKE PEDAL GROMMET

VESPA 50 (V5SS '66-'71 / V5A1T dal telaio 92877 '65-'67)
VESPA 90 (V9SS '65-'71) - VESPA 125 (VNA 1/2T '58-'59)
VESPA 125 ET3 (VMB1 '76-'83)

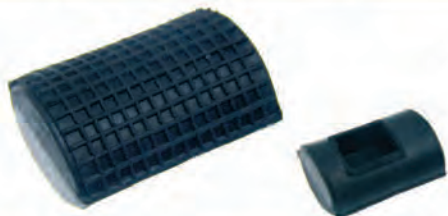

ART. **G0900** GOMMINO PROTEZIONE LEVA FRENO

BRAKE PEDAL GROMMET

VESPA 50 (V5A1T 914748>) - 50 SPECIAL (V5B3T 230536>)
VESPA 50 S (V5SA1T 79735>) - 90 (V9A1T 184927>)
VESPA 100 (V9B1T 5363>) - 125 PRIMAVERA (VMA2T 0192145>)
VESPA ET3 - PX 125-150-200



ART. **5971** GOMMINO PER LEVA AVVIAMENTO (Sim. 049642)

RUBBER FOR STARTER LEVER

VESPA TUTTI TIPI (DAL 1959 AL 1985)



ART. **5970** GOMMINO PER PEDIVELLA AVVIAMENTO (Sim.241004)

RUBBER FOR KICK STARTER LEVER

VESPA PX PE - SPRINT - SUPER - RALLY



ART. **5101** TAMPONE RISCOント SETTORE AVVIAMENTO (Sim.165206)

STOP BUFFER

VESPA 50 - 90 - 125 PRIMAVERA - ET3 - PK



ART. **5101-XL** TAMPONE RISCOント SETTORE AVVIAMENTO (Sim.078578)

STOP BUFFER

VESPA PK XL 50-125



ART. **5106** TAMPONE RISCOント SETTORE AVVIAMENTO (Sim.178338)

STOP BUFFER

VESPA PX PE TUTTI TIPI / ALL MODELS



PARTI IN GOMMA

RUBBER PARTS



- ART. **5342** GOMMINO NERO \varnothing mm.22 (Sim.194631)
PER ASTA RUBINETTO BENZINA
BLACK GROMMET \varnothing mm.22, FOR FUEL COCK ROD
VESPA PXE ARCOBALENO 125/150/200E
VESPA PX 125-PX 125/150(11-17)-PX EU2 125 - T5 125



- ART. **5343** GOMMINO NERO PER ASTA RUBINETTO BENZINA (Sim.132538)
BLACK GROMMET FOR FUEL COCK ROD
VESPA 50-125 - PK 50 - PK 50/125 XL - RUSH 50



- ART. **5343-G** GOMMINO GRIGIO PER ASTA RUBINETTO BENZINA
GREY GROMMET FOR FUEL COCK ROD
VESPA VECCHI MODELLI



- ART. **5720** GUARNIZIONE PER RUBINETTO BENZINA (Sim.013836)
FUEL COCK GASKET
VESPA 50-90-125 PRIMAVERA - ET3 - PX PE



- ART. **5720-V** GUARNIZIONE IN **VITON** X RUBINETTO BENZINA (Sim.013836)
FUEL COCK **VITON** GASKET
VESPA 50-90-125 PRIMAVERA - ET3 - PX PE



- ART. **5317** GUARNIZIONE PER SERBATOIO (Sim. 71734)
TANK FUEL GASKET
VESPA 50 - 125 ('67-'82) - VESPA 50 S - 50 L - R
VESPA 50 SPECIAL - 90 - 100 - 125 PRIMAVERA - ET3



\varnothing interno/internal mm.55
 \varnothing esterno/external mm.73
spessore/thickness mm. 3

- ART. **5335-GZ** GUARNIZIONE TAPPO SERBATOIO BENZINA (Sim.002319)
TANK FUEL PLUG GASKET
VESPA TUTTI MODELLI (DAL '46 AL '83)
VESPA 125 (VN1-VN2-VNA-VNB)
VESPA PX 125-150 - P200E



\varnothing interno/internal mm.37,5
 \varnothing esterno/external mm.51
spessore/thickness mm. 2,5

- ART. **5316** GUARNIZIONE TAPPO SERBATOIO BENZINA
FUEL PLUG GASKET
VESPA FL 50 (90)-FL 125 (89-90)-FL2 AUTOMATICA 50 (90-91)
VESPA FL2 HP 50 (91-97) - N 50 (89-90)
VESPA PK AUTOMATICA 50 (84-89) - PK XL 50(85-88)
VESPA PK XL 125 (86-89) PK XL PLURIMATIC 50 (85-90)
VESPA RUSH XL 50 (88-89) - PX 125 (98-01) - PX 150 (11)
VESPA PX 30 ANNI 125 (07-08) - PX EU2 125 (01-07)
VESPA PXE ARCOBALENO 125 (81-97) - T5 125 (85'89)



- ART. **5355** GUARNIZIONE PER BICCHIERINO SPIA OLIO MIX (Sim.102587)
GASKET FOR PLASTIC GLASS X CHECKING THE OIL LEVEL
VESPA PX 125-150-200 - PX PE ARCOBALENO
VESPA 125 T5 - RALLY

PARTI IN GOMMA

RUBBER PARTS



ART. 6147-A SPEZZONE cm.50 GUARNIZIONE PER DEPURATORE (Sim.239049) (Sim. 058853)
GASKET FOR AIR CLEANER, cm. 50
VESPA PX PE - SPRINT - RALLY



ART. 7514 TAPPO SCATOLA DEPURATORE (Sim. 050274)
BOX CLEANER CAP
VESPA PX PE 125-150-200 E ARCOBALENO



ART. 7515 TAPPO COPERCHIO SCATOLA FILTRO (Sim. 087975)
FILTER BOX CLEANER CAP
VESPA 50-90-125 PRIMAVERA - ET3



ART. G1713 GUARNIZIONE BLOCCASTERZO (Sim. 122296)
SECURITY LOCK GASKET
VESPA (FINO AL 1977) - 50N - L - R - SPECIAL -50SS (V5SA1T)
VESPA 125 PRIMAVERA (VMA1T-2T) -SUPER (VNC1T) (VBC1T)
VESPA GT (VNL2T) - GTR (VNL2T) - TS (VNL3T) -GL (VLA1T)
VESPA SPRINT (VLB1T) - SPRINT VELOCE (VLB1T)
VESPA GS 160 (VSB1T 0055507->) - 180SS (VSC1T)
VESPA RALLY 180-200 (VSD1T - VSE1T)

ART. 1920

GUARNIZIONE CLACSON
CON **BORDO SMUSSATO**
CLACSON GASKET
WITH **BEVELED EDGE**

(Sim. 92648)

VESPA 50 (V5A1T '63->'83) (V5SS1T '66->'71)
VESPA 90 (V9A1T '63->'68) (V9SS1T '65->'71)
VESPA 125 (VNB2T DAL/FROM 4718)
VESPA 150 (VBB1T DAL/FROM 32070)
VESPA SUPER 125 ('66->'68) - SUPER 150 (66->'79)



ART. 1922

GUARNIZIONE CLACSON
CLACSON GASKET

SPESSORE/TICKNESS 4 mm.

VESPA 125 (VNB1->6 '60->'66)
VESPA 150 (VL1T->3T '55->'56) - (VB1T '57->'58)
VESPA 150 (VBA1T '59->'60) - (VBB1T->2T '61->'66)
VESPA GS 150 (VS1T->5T '55->'58) - GS 160 (VSB1T '62->'64)



ART. 1925

GUARNIZIONE CLACSON NERA
CLACSON BLACK GASKET

(Sim. 174091-120798)

VESPA 125 PRIMAVERA - ET3



ART. 1923

GUARNIZIONE CLACSON
CLACSON GASKET

SPESSORE/TICKNESS 2 mm.

VESPA 125 :
(V15T '50) - (VM1/2T '53->'54)
(DAL V30T AL V33T '51->'52)
(VU1T) - (VN1/2T '58->'59)
(VNA 1/2T '58->'59) - (VNB1>6T '60->'66)



ART. 1921

GUARNIZIONE CLACSON CON
BORDO SMUSSATO
CLACSON GASKET WITH **BEVELED EDGE**

VESPA SUPER 125 (VNC1T '66->'68)
GRAN TURISMO 150 (VNL2 DAL 30001 '66->'73)
VESPA GL 150 (VLA1T '63->'64)
VESPA 180 SS (VSC1T '65-<'68)
VESPA SPRINT 150 ('65->'74)
VESPA SPRINT VELOCE ('69->'79)



CHIAVI CANDELA

PLUG SPARK TOOLS



ART. **3300** ESAGONO 11 x 13 x 21

ART. **3301** ESAGONO 13 x 17 x 21

ART. **3302** ESAGONO 11 x 17 x 21

ART. **3303** ESAGONO 13 x 13 x 21

PER VESPA 50-90-125 ET3-PK-FL-FL2



ART. **3304** ESAGONO 14 X 22 X 11 VESPA 125 - 150

ART. **3305** ESAGONO 13 X 22 X 11 VESPA 125 - 150

PER TUTTE LE VESPE / FOR ALL VESPA
(ESCLUSO/EXCEPT: VESPA 50-90-125 PRIMAVERA - PRIMAVERA ET3)

DELLORTO



BOSCH



ART. **1100** Candela BOSCH **W7AC**-filetto **CORTO** (NGK **B6HS**)

PLUG SPARK BOSCH **W7AC-SHORT** thread (NGK **B6HS**)

APPLICATIVI **SUGGERITI** / SUGGESTED APPLICATIONS:

VESPA DAL 1946 AL 1977 - VESPA 98

VESPA 50 - 50 SPECIAL -N-L-R

VESPA 125 ('50-'52) (da V30 a V33)

VESPA 125 ('53-'57) (VM1-2)-(VN1-2)-(VNA1-2)- (dal VNB1 al VNB6)

VESPA 125/150 SUPER-125 GT-GTR-SPRINT VELOCE-SPRINT

VESPA 150 ('55-'65) - (VL1-2-3) - (VB1)-(VBA)-(VBB1-VBB2)

VESPA PX 125/150 - CIAO SI' - BRAVO - BOXER

VITI PER COPERCHI VENTOLA

FAN COVER SCREWS

VITI TESTA CILINDRICA TAGLIO CACCIAVITE

fissa copriventola VESPA fino al 1981

ART. **3106-T10** M6 x mm.10

ART. **3106-T12** M6 x mm.12

ART. **3106-T16** M6 x mm.16

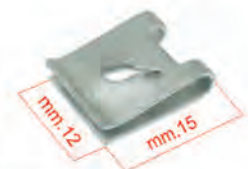

ART. **10373**

PIASTRINA
PER VITE AUTOFILETTANTE Ø mm.4,8

FISSA CUFFIA/COPRIVENTOLA
VESPA 50-90-125 PRIMAVERA-ET3 - PK

(Sim.008112)

VITI TESTA CILINDRICA A CROCE

fissa copriventola VESPA dal 1982

ART. **3106-C10** M6 x mm.10

ART. **3106-C12** M6 x mm.12

ART. **3106-C16** M6 x mm.16



ART. **5383-C**

VITE AUTOFILETTANTE
TESTA CILINDRICA A CROCE
FILETTO Ø mm.4,8x13

FISSA CUFFIA/COPRIVENTOLA
VESPA 50-90-125 PRIMAVERA-ET3 - PK

(Sim.008265)



COPERCHI VENTOLA

FAN COVERS

VESPA 50 - 90 - 125 PRIMAVERA - ET3



ART. **5093-C**
IN FERRO - CROMATO
CHROMED IRON
(Sim.2447355)



ART. **5093-N**
IN FERRO - NERO
BLACK PAINTED IRON



ART. **5093-G**
IN FERRO
VERNICIATO GRIGIO ORIGINALE
ORIGINAL GREY PAINTED IRON
(Sim.2447355)



ART. **5093-CARB**
IN FERRO
IRON
**EFFETTO CARBONIO
LOOK CARBONIO**

CARBONIO LOOK

VESPA PX PE TUTTI MODELLI / ALL MODELS



ART. **5099-C**
IN FERRO - CROMATO
CHROMED IRON
(Sim.610236M)



ART. **5099-N**
IN FERRO - NERO
BLACK IRON
(Sim. 194362)



ART. **5099-G**
IN FERRO
VERNICIATO GRIGIO ORIGINALE
ORIGINAL GREY PAINTED
IRON
(Sim.610236M)



ART. **5099-CARB**
IN FERRO
IRON
**EFFETTO CARBONIO
LOOK CARBONIO**

CARBONIO LOOK



COPERCHI VENTOLA

FAN COVERS

**VESPA PX 125/150-200 FRENO A DISCO/BRAKE DISC - PXE ARCOBALENO 125/150/200
VESPA COSA CL - CLX 125/150/200 - COSA 2 125/150/200**



ART. **5094-C**
CROMATO
CHROMED
(Sim.436543)



ART. **5094-G**
VERNICIATO GRIGIO
GREY PAINTED IRON
(Sim.436543)



ART. **5094-N**
ORIG. COLORE NERO
BLACK ORIG. PAINTED
(Sim.2856075)

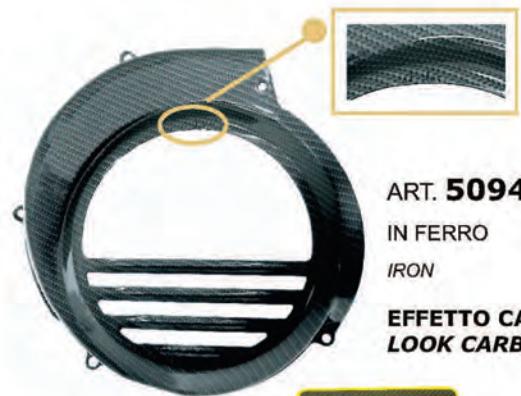

ART. **5094-CARB**
IN FERRO
IRON
**EFFETTO CARBONIO
LOOK CARBONIO**

VESPA 125 T5



ART. **5091-N**
ORIG. COLORE NERO
BLACK ORIG. PAINTED
(Sim.2351566)



ART. **5091-CARB**
IN FERRO
IRON
**EFFETTO CARBONIO
LOOK CARBONIO**

CUFFIE RAFFREDDAMENTO CILINDRO COOLING HOODS

VESPA 50 - PK 50 - PK 50 XL - 50 FL - RUSH - N



ART. **8164**

CUFFIA RAFFREDDAMENTO CILINDRO

VESPA 50 - PK 50 - PK 50 XL - 50 FL - RUSH - N

(Sim. 139261)



CARBON LOOK

ART. **8164-CARB**

CUFFIA RAFFREDDAMENTO CILINDRO

**EFFETTO CARBONIO
LOOK CARBONIO**

VESPA 50 - PK 50 - PK 50 XL - 50 FL - RUSH - N

VESPA 125 PRIMAVERA - ET3 - PK 125 - PK 125 XL



ART. **8165**

CUFFIA RAFFREDDAMENTO CILINDRO

VESPA 125 PRIMAVERA - ET3 - PK 125 - PK 125 XL

(Sim. 174702)



CARBON LOOK

ART. **8165-CARB**

CUFFIA RAFFREDDAMENTO CILINDRO

**EFFETTO CARBONIO
LOOK CARBONIO**

VESPA 125 PRIMAVERA - ET3 - PK 125 - PK 125 XL



CUFFIE RAFFREDDAMENTO CILINDRO

COOLING HOODS

VESPA PX 125 - PX 150



ART. **8168**

CUFFIA RAFFREDDAMENTO CILINDRO

VESPA PX 125 - PX 150

(Sim. 431056)



CARBON LOOK

ART. **8168-CARB**

CUFFIA RAFFREDDAMENTO CILINDRO

**EFFETTO CARBONIO
LOOK CARBONIO**

VESPA PX 125 - PX 150

VESPA PE 200 - PX 200 - RALLY 180/200



ART. **8166**

CUFFIA RAFFREDDAMENTO CILINDRO

VESPA PE 200 - PX 200 - RALLY 180/200

(Sim. 431054)



AR. **5090**

CONVOGLIATORE ARIA ESTERNO NERO
BLACK OUTSIDE AIR CONVEYOR

VESPA 50 - 125 PRIMAVERA - 125 PRIMAVERA ET3

SPORTELLI MOTORE

ENGINE DOORS



ART. **5095**

SPORTELLINO VANO MOTORE

VESPA 50 - 90 - 125 PRIMAVERA ET3

(Sim. 1310906)



ART. **5095-CARB**

SPORTELLINO VANO MOTORE

EFFETTO CARBONIO
LOOK CARBONIO

VESPA 50 - 90 - 125 PRIMAVERA ET3



ART. **5205**

COMPLESSIVO LEVETTA SPORTELLINO

LEVER KIT FOR ENGINE DOOR

VESPA 50 - 90 - 125 PRIMAVERA ET3

(Sim. 131093)

(RICAMBIO PER NS.RIF.5095 e 5095-CARB)
(SPARE FOR OUR CODE 5095 and 5095-CARB)



ART. **5206**

LEVETTA SPORTELLINO LATERALE PORTA OGGETTI

LEVER FOR LATERAL TOOL BOX DOOR

VESPA 125 ('62>'66) - VESPA 150 ('59-'66)



SPORTELLI MOTORE

ENGINE DOORS



ART. **6137**

COPPIA GANCI RITEGNO COFANI
COMPLETA DI GOMMINO E BOCCOLA

PAIR HOOKS RETAINER COWLS
COMPLETE WITH RUBBER AND BUSH

VESPA RALLY 180-200
VESPA PX PE 1ª SERIE FINO AL 1980

adattabile a / suitable to :
VESPA GS 160 - 180SS



ART. **6138**

GANCIO RITEGNO COFANO
DESTRO (LATO MOTORE)
COMPLETO DI GOMMINO E BOCCOLA

HOOK RETAINER RIGHT COWL
(ENGINE SIDE)
COMPLETE WITH RUBBER AND BUSH

VESPA DAL 1959 AL 1976



ART. **5709**

TUBETTO PROTEZIONE
AGGANGI COFANI LATERALI

PROTECTION TUBE
FOR HOOKS RETAINER COWLS

VESPA PX PE 125/150/200

(Sim. 024041)



ART. **5080**

SPORTELLINO ACCESSO MOTORE TIPO PICCOLO
CON ATTACCHI FRONTALI
COMPLETO DI LEVETTA

DOOR ACCESS TO ENGINE, SMALL TYPE
WITH FRONT CONNECTIONS
COMPLETE WITH LEVER

VESPA 50 N (FINO AL TELAIO / TILL TO FRAME 70239)
VESPA 50 S (FINO AL TELAIO / TILL TO FRAME 11764)
VESPA 90 (FINO AL TELAIO / TILL TO FRAME 19974)



ART. **5081**

SPORTELLINO ACCESSO MOTORE TIPO PICCOLO
CON ATTACCHI LATERALI
COMPLETO DI LEVETTA

DOOR ACCESS TO ENGINE, SMALL TYPE
WITH LATERALS CONNECTIONS
COMPLETE WITH LEVER

VESPA 50 L - R (VSA1T)
VESPA 50 S (FINO AL TELAIO / TILL TO FRAME 15234)
VESPA 90 (FINO AL TELAIO / TILL TO FRAME 022224)

GUARNIZIONI COFANI-BAULETTI

SIDEPANELS-DOOR TOP BOXES RUBBER PROFILES



ART. **6149**

GUARNIZIONE IN GOMMA NERA X COFANI LATERALI (Sim.196230)
BLACK RUBBER PROFILE FOR SIDEPANELS 161995)

VESPA PX PE
SPRINT VELOCE (VLB1 dal TELAIO 172651 - dal 1974)

(CONFEZIONE DI N. 1 SPEZZONE MT. 3,00 A MISURA PER UNA VESPA)
(PACKAGING OF 1 PIECE, LENGHT MT.3,00 - MEASURE FOR ONE VESPA)



ART. **6149-G**

GUARNIZIONE IN GOMMA GRIGIA X COFANI LATERALI
GREY RUBBER PROFILE FOR SIDEPANELS

VESPA VECCHI MODELLI
VESPA GS 160 (VSB1T) - SS 180 (VSC1T) - GL 150 (VLA1T)
VESPA SUPER 125/150 (VNC1T - VBC1T) - GT 125 (VNL2T)
VESPA GTR (VNL2 dal 100001 AL 109849) - SPRINT 150 (VLB1T)
VESPA SPRINT VELOCE (VLB1T dal 150001 al 172650)

(CONFEZIONE DI N. 1 SPEZZONE MT. 3,00 A MISURA PER UNA VESPA)
(PACKAGING OF 1 PIECE, LENGHT MT.3,00 - MEASURE FOR ONE VESPA)



ART. **6152-G**

GUARNIZIONE IN GOMMA GRIGIA X COFANI LATERALI (Sim.011751)
GREY RUBBER PROFILE FOR SIDEPANELS

VESPA 125 (CAMBIO A BACCHETTA) ('49-'50 dal V11T al V15T)
VESPA 125 (CAMBIO A FILO) ('51-'52 dal V30T al V33T)
(VM1T-VM2T-VN1T-NT2T '53-'57)-(VNA1T-VNA2T '57-'58)
(dal VNB1T al VNB6T '59-'65)
VESPA 150 (VL1T-VL2T-VL3T '54-'57) - (VB1T '58) - (VBA1T '59)
(VBB1T-VBB2T dal '60 al '65)
VESPA GS 150 ('55-'61 dal VS1T al VS5T)

(CONFEZIONE DI N.1 SPEZZONE MT. 3,00 A MISURA PER UNA VESPA)
(PACKAGING OF 1 PIECE, LENGHT MT.3,00 - MEASURE FOR ONE VESPA)



ART. **6148**

GUARNIZIONE IN GOMMA PER BAULETTO (Sim.183546)
RUBBER PROFILE FOR TOP BOX

VESPA PX PE - PK

(CONFEZIONE PER IL MONTAGGIO DI UN BAULETTO)
(PACKAGING FOR ASSEMBLY 1 TOP BOX)



ART. **6147-MT**

GUARNIZIONE PER SPORTELLO BAULETTO O ALTRI UTILIZZI
RUBBER GASKET FOR DOOR TOP BOX, CLEANER

VESPA 50 - PK - PX

(CONFEZIONE / PACKAGING 10 MT.)



ART. **5710**

GOMMINO PER BATTUTA COFANO/SPORTELLO (Sim.232222)
MOTORE
BUFFER FOR ENGINE COWLS, SIDEPANELS

VESPA 50 - 90 - 125 PRIMAVERA - ET3



ART. G1762

SERIE MODANATURE DI PROTEZIONE
PER COFANI LATERALI (IN GOMMA NERA)
(SISTEMA DI FISSAGGIO CON AGGANCI)

*RUBBER FENDER SET PROTECTION FOR SIDEPANELS
(BLACK RUBBER) (MOUNTING SYSTEM WITH HOOKS)*

VESPA 50 - 90 - 125 PRIMAVERA - ET3



CARBON LOOK

ART. 7240

COPERCHIO FORO ALLOGGIO CONTAKM

SPEEDOMETER KMS COVER

VESPA 50

(Sim. 123678)

ART. 7240-CARB

COPERCHIO FORO ALLOGGIO CONTAKM
EFFETTO CARBONIO

*SPEEDOMETER KMS COVER **LOOK CARBONIO***

VESPA 50



ART. 5306

GANCIO PORTA BORSA
IN ALLUMINIO

ALLUMINIUM HOOK FOR BAGS

VESPA 50-90-125 PRIMAVERA-ET3

(Sim. 57468)

ART. 5306-AN

GANCIO PORTA BORSA
IN ALLUMINIO NERO

BLACK ALLUMINIUM HOOK FOR BAGS

VESPA 50-90-125 PRIMAVERA-ET3-PK-PX-T5
VESPA RALLY-SPRINT-GTR-GT-GL-SUPER-GS
VESPA VNA-VNB-VBA-VBB

PORTA OGGETTI-ATTREZZI

TOOLS BOX



ART. **6187**

PORTA OGGETTI (SOPRA AL BAULETTO)

HOLDING OBJET (OVER THE TOP BOX)

VESPA PK - RUSH - N

(Sim. 248188)



ART. **5092**

SCATOLA PORTA ATTREZZI

TOOLS BOX

VESPA 50 - 90 - 125 PRIMAVERA - ET3

(Sim.100389)



ART. **6189**

SCATOLA PORTA ATTREZZI

TOOLS BOX

VESPA PK - FL - VESPA HP - RUSH - N

(Sim.219383)



RIBATTINI DA RESTAURO

RESTAYLING RIVETS



ART. 5379-T

MICRORIBATTINO IN ALLUMINIO - TESTA BOMBATA
ALUMINIUM MICRO-RIVET

STELO/STEM \varnothing mm. 1,5 x 3

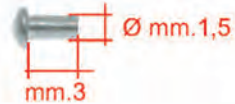

**PER FISSAGGIO TARGHETTE TRAFORATE
FIX PERFORATED NAMEPLATE**



(confezione / packaging 100 pz./pcs.)



ART. 5379-A

MICRORIBATTINO IN FERRO
IRONIC MICRO-RIVET

TESTA BOMBATA

(Sim. S10820)

STELO/STEM \varnothing mm. 2 x 3,5

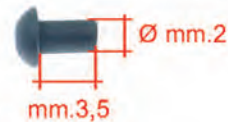

(confezione / packaging 50 pz./pcs.)



ART. 5379-B

MICRORIBATTINO IN ALLUMINIO - TESTA BOMBATA
ALUMINIUM MICRO-RIVET

STELO/STEM \varnothing mm. 2 x 8

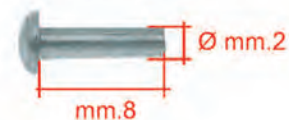

(confezione / packaging 50 pz./pcs.)



ART. 5748

MOLLETTA ELASTICA
PER FISSAGGIO TARGHETTE IN ALLUMINIO TUTTI TIPI

ELASTIC SPRING FOR FIXING ALL MODELS OF ALLUMINIUM NAMEPLATE

(Siim. 008108)

**VESPA
OLD MODELS**

TARGHETTE SPESSORE FINE
NAMEPLATES, FINE THICKNESS



ART. **5745**

ANTERIORE IN ALLUMINIO
FRONT IN ALUMINIUM
lunghezza / length mm. 140

VESPA 125 (VN1-2) - VESPA 125 (VNA 1-2) (dal '55-'59)



ART. **5745-CR**

ANTERIORE NICHELATA PIU' SPESSA
FRONT (Sim.002790)
lunghezza / length mm. 140

VESPA 98 ('47) - 125 ('48-'54) - 150 (VL1-2-3-VB1)



ART. **5741**

ANTERIORE IN ALLUMINIO VERNICIATA COLORE **BLU NOTTE**
FRONT IN ALUMINIUM, **BLUE NIGHT** COLOUR PAINTEND (Sim.086325)
lunghezza / length mm. 105

VESPA 125 (VNB1-2-3) (dal '60-'66)



ART. **5738**

ANTERIORE ACCIAIO INOX LUCIDO FINE
FRONT, FINE POLISHED INOX STEEL (Sim.084809)
lunghezza / length mm. 140

VESPA 150 (VBA PROD.1960 - VBB1-VBB2)

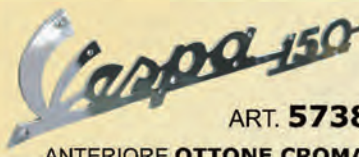

ART. **5738-OC**

ANTERIORE **OTTONE CROMATO** COME L'ORIGINALE
FRONT **CHROMED BRASS** AS ORIGINAL
lunghezza / length mm. 140

VESPA 150 (VBA) ('58-'59)



ART. **5744**

ANTERIORE IN ALLUMINIO NERA / FRONT IN BLACK ALUMINIUM
lunghezza / length mm. 165

VESPA GL



ART. **5743**

ANTERIORE IN ALLUMINIO NERA
FRONT IN BLACK ALUMINIUM
lunghezza / length mm. 140

VESPA GS 150 (VS1-2-3-4) ('55-'61)



ART. **5743-L**

ANTERIORE IN ALLUMINIO VERNICIATA COLORE **BLU NOTTE**
FRONT, **BLUE NIGHT** COLOUR PAINTED, ALUMINIUM
lunghezza / length mm. 170

VESPA GS 160 (VSB1) ('62-'64)

PVC ADESIVO NERO
BLACK ADHESIVE PVC



ART. **3378**

ANTERIORE / FRONT (Sim. 094454)
lunghezza / length mm. 105

VESPA 125 (VNB4-VNB5) ('63-'65)

PVC ADESIVO NERO
BLACK ADHESIVE PVC

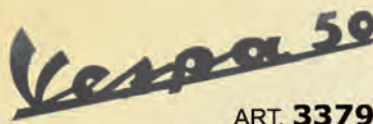

ART. **3379**

ANTERIORE / FRONT (Sim. 090494)
lunghezza / length mm. 130

VESPA 50 ('63-'71)



TARGHETTE TRAFORATE

ALUMINIUM PIERSED NAMEPLATES

VESPA OLD MODELS

IN ALLUMINIO ANTERIORI E POSTERIORI CON PIOLETTI D'ATTACCO

VESPA 50 SPECIAL ('69-'72)

ART. **5740-SP**
ANTERIORE / FRONT
lunghezza / lenght mm. 120

ART. **5726**
ANTERIORE / FRONT
(Sim.610288M)

ART. **5728**
POSTERIORE / REAR (Sim.126072)
lunghezza / lenght mm. 130

VESPA 50 L

ART. **5731**
ANTERIORE / FRONT
lunghezza / lenght mm. 135
monta anche su: VESPA 50 R ('70-'75)

ART. **5729**
POSTERIORE / REAR (Sim.151712)
lunghezza / lenght mm. 150

VESPA PRIMAVERA ('68-'74)

ART. **5734**
ANTERIORE / FRONT
lunghezza / lenght mm. 140
monta anche su: VESPA 125 NUOVA ('65-'66)

ART. **5730**
POSTERIORE / REAR
lunghezza / lenght mm. 160
VESPA PRIMAVERA (fino a/till to '74)

VESPA SPRINT 150 (VLB1 '65-'66)

ART. **5727**
ANTERIORE / FRONT (Sim. 090556)
lunghezza / lenght mm. 155

ART. **5736-P**
POSTERIORE / REAR
lunghezza / lenght mm. 130

**VESPA
OLD MODELS**

TARGHETTE TRAFORATE
ALUMINIUM PIERSED NAMEPLATES

IN ALLUMINIO ANTERIORI E POSTERIORI CON PIOLETTI D'ATTACCO

VESPA SPRINT 150 (VLB1 '67-'69) - SPRINT VELOCE



ART. 5740-A
ANTERIORE / FRONT
lunghezza / length mm. 130
monta anche su:
SUPER - RALLY 180

ART. 5735-A
ANTERIORE / FRONT
lunghezza / length mm. 80



ART. 5735-P
POSTERIORE / REAR
lunghezza / length mm. 173



ART. 5737-P
POSTERIORE / REAR
lunghezza / length mm. 178

VESPA SUPER



ART. 5740-A
ANTERIORE / FRONT
lunghezza / length mm. 130
monta anche su:
SPRINT - RALLY 180

ART. 5725-A
ANTERIORE / FRONT
lunghezza / length mm. 75



ART. 5725-P125
POSTERIORE / REAR (Sim.150498)
lunghezza / length mm. 115



ART. 5725-P150
POSTERIORE / REAR (Sim.121081)
lunghezza / length mm. 115

VESPA 180 SS ('64)



ART. 5733-A
ANTERIORE / FRONT (Sim. 090496)
lunghezza / length mm. 173

ART. 5733-P
POSTERIORE / REAR (Sim.100042)
lunghezza / length mm. 170



TARGHETTE TRAFORATE

ALUMINIUM PIERSED NAMEPLATES

VESPA OLD MODELS

IN ALLUMINIO ANTERIORI E POSTERIORI CON PIOLETTI D'ATTACCO

VESPA GRAN TURISMO



ART. **5732-A**

ANTERIORE / FRONT (Sim.151713)
lunghezza / length mm. 165

ART. **5737**

ANTERIORE / FRONT

ART. **5732-P**

POSTERIORE / REAR (Sim.151714)
lunghezza / length mm. 170

VESPA RALLY 180

ART. **5740-A**

ANTERIOR / FRONT
lunghezza / length mm. 130
monta anche su: SUPER - SPRINT

ART. **5742**

ANTERIORE / FRONT
lunghezza / length mm. 90

ART. **5742-P**

POSTERIORE / REAR
lunghezza / length mm. 160

VESPA RALLY 200 ('72-'74)

ART. **5740**

ANTERIORE / FRONT
lunghezza/length mm. 120
VESPA RALLY 200 ('72-'74)

ART. **5767**

POSTERIORE / REAR (Sim.141828)

VESPA 150

ART. **10013**

2 PIOLI - INTERASSE mm.23

LAMBRETTA

ART. **10015**

lunghezza / length mm. 210

VESPA OLD MODELS

SCUDETTI ANTERIORI FRONT EMBLEMS

ART. 5746-M
STEMMA RESINATO IN METALLO "PIAGGIO"
METAL RESINED EMBLEM
INTERASSE STRETTO / STRAIT WHEELBASE
VESPA 150 ('57-'59)
VESPA GS (DAL VS2 AL VS4) - (VS1 DAL/SINCE 9775)

ART. 5746-MG
STEMMA RESINATO IN METALLO "PIAGGIO GENOVA"
METAL RESINED EMBLEM
INTERASSE STRETTO / STRAIT WHEELBASE
VESPA DAL 1953 AL 1956
VESPA GS (VS1 FINO AL /TILL TO 9775)

ART. 5746-MGL
STEMMA RESINATO IN METALLO "PIAGGIO GENOVA"
METAL RESINED EMBLEM
INTERASSE LARGO / LARGE WHEELBASE
VESPA 125 (1951-1954)

ART. 5746-MVN
STEMMA RESINATO IN METALLO "PIAGGIO"
CON POCA RESINA COME L'ORIGINALE
METAL RESINED EMBLEM WITH LITTLE RESIN AS ORIGINAL
INTERASSE LARGO / LARGE WHEELBASE
VESPA 125 (1955-1957 economica)
VN1/VN2 (modelli a 7 listelli strisce pedana)

ART. 5746
STEMMA ADESIVO RESINATO
(mm. 38x48)
RESINED ADHESIVE EMBLEM
VESPA
VECCHI MODELLI / OLD MODELS

ART. 5747
EMBLEMA PICCOLO ADESIVO IN ALLUMINIO
(mm. 25x28) (Sim. 070312)
SMALL EMBLEM, ADHESIVE IN ALUMINIUM
VESPA 50 - 50S - 50SS
(sportello piccolo/small engine door)
VESPA 90 - 90 SS - VESPA 125 PRIMAVERA
NUOVA VESPA 125('66)(sportello grande fino al '68/(big engine door till to '68)

ART. 5749
EMBLEMA GRANDE ADESIVO
IN ALLUMINIO (mm. 36x46)
BIG EMBLEM, ADHESIVE IN ALUMINIUM
VESPA 125 VECCHI MODELLI / OLD MODELS
(Sim. 024858)

ART. 5749-FO
EMBLEMA GRANDE IN ALLUMINIO
(mm. 36x46)
CON FORI PER FISSAGGIO A RIVETTI
BIG EMBLEM IN ALUMINIUM
WITH HOLES FOR RIVETS FIXING
VESPA 125 VECCHI MODELLI / OLD MODELS
(Sim. 024858000F)



SCUDETTI ANTERIORI FRONT EMBLEMS



ART. 5781
SCUDETTO ADESIVO GRANDE
BIG, ADHESIVE
ESAGONO **mm. 42**
(Sim. 152290)



ART. 5776
SCUDETTO ADESIVO MEDIO
MEDIUM, ADHESIVE
ESAGONO **mm. 31**
(Sim. 195577)



ART. 5778
SCUDETTO ADESIVO PICCOLO
SMALL, ADHESIVE
ESAGONO **mm. 26**
(Sim. 152280)

ART. 5776-R
SCUDETTO RESINATO ADESIVO
RESIN-TREATED EMBLEM ADHESIVE
ESAGONO **mm. 32**
bordo fine / slim edge mm. 1
grafia logo fine / slim writing logo
(Sim. 295596)



ART. 5776-RN
SCUDETTO RESINATO ADESIVO
RESIN-TREATED EMBLEM ADHESIVE
ESAGONO **mm. 32**
bordo grosso / large edge mm. 2
grafia logo grossa / large writing logo
(Sim. 574771)

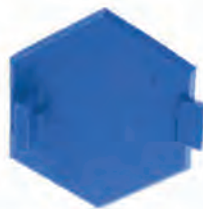

ART. 5785
SCUDETTO AD INCASTRO PER MASCHERINA
FOR HORNCAST
VESPA PX ARCOBALENO - 125 T5 - PK XL 50-125
VESPA RUSH 50 - FL2 - N - HP
(Sim. 252970)



ART. 5785-R
SCUDETTO RESINATO AD INCASTRO PER MASCHERINA
RESINED IN RELIEF FOR HORNCAST
VESPA PX - PXE ARCOBALENO - 125 T5 - PK - PK XL
VESPA FL2 - HP - ET2 - ET4
(Sim. 295486)



ART. 5782
SCUDETTO RETTANGOLARE AD INCASTRO
VESPA ET4 50 ('00-'05)-ET4 125-150 ('99-'02)-LX 125-150 ('05-'06)
LX 2T - 4T 125-150 ('05-'06) - LX EU3 125-150 ('06-'08)
LXV 2T 50 ('06-'08)-LXV 2T NAVY 50 ('08)-LXV 4T EU3 125 ('06-'08)
LXV 4T NAVY EU3 125 ('08) - GRANTURISMO 125 ('03-'07)
GRANTURISMO 200 ('06-'07) - GRANTURISMO EU3 125 ('06-'07)
GT 60 EU3 250 ('06-'07) - GTS EU3 125 ('07-'08)
GTS SUPER 300 ('08) - GTS-GTS ABS 250 (05-08)-GTV 125 (07-08)
GTV 250 (06-07) - GTV 4T NAVY EU3 125-250 ('08)
PX 30 ANNI 125 ('07-'08) - PX EU2 125 ('01-'07)
VESPA S 2T 50 ('07-'08)-VESPA S 4T EU3 125('07-'08)
APE CALESSINO 420 ('07-'08)
(Sim. 576464)

TARGHETTE ANTERIORI

FRONT NAMEPLATES

PIAGGIO

ART. **6102**

TARGHETTA ADESIVA PER MASCHERINA
ADHESIVE FOR HORNCAST
VESPA PK

(Sim.216719)

PIAGGIO

ART. **5780**

TARGHETTA ADESIVA
ADHESIVE

(Sim.182346)

PIAGGIO

ART. **5780-R**

TARGHETTA RESINATA ADESIVA
RESINED, ADHESIVE

(Sim. 298723)

PIAGGIO

ART. **5784**

TARGHETTA AD INCASTRO PER MASCHERINA
FOR HORNCAST

VESPA PX ARCOBALENO
VESPA 125 T5....

(Sim.232895)

PIAGGIO

ART. **5775**

TARGHETTA PER MASCHERINA / FOR HORNCAST
VESPA PX PE

(Sim.181329)

PIAGGIO

ART. **5783**

KIT TARGHETTA+SCUDETTO+VITE
PER MASCHERINA / FOR HORNCAST

VESPA PX PE





TARGHETTE SCUDO ANTERIORE

FRONT NAMEPLATES



vespa



ART. **5750**

(interasse fra pioli / wheelbase between pins **mm. 80**)
(Sim.152541)

VESPA:

50 R (da V5A1T 828604 ->)
50 SPECIAL (da V5B1T 38640->)(V5B2T 1869->)
50 SPECIAL (V5B3T tutte/all)
90 (da V9A1T 77697 ->)
125 PRIMAVERA (da VMA2T 073489->)
ET3 (VMB1T tutte/all)
GTR 125 (da VNL2T 127358 ->)
RALLY 200 (da VSE1T 0010824 ->)
SPRINT VELOCE (da VLB1T 0172641->)
TS 125 (VNL3 tutte/all)
PX 125 (tutte/all da VNX1T -> VNX2T 65160)
PX 150 (tutte/all fino a / all till to VLX1T 436000)
PX 200 (tutte/all fino a / all till to VSX1T 148028)

vespa



ART. **6101**

(interasse fra pioli / wheelbase between pins **mm. 59**)
(Sim.241012-194955)

VESPA PX 125 (dal VNX2T 65161 -> 200000)
VESPA PX 150 (dal VLX1T 436001 -> 600000)
VESPA PX 200 (dal VSX1T 148029 -> 300000)

vespa

ART. **6101-S**

(misure mm. 18x120) SATINATA
(Sim. 241012-197601)

VESPA PX - PX ARCOBALENO

vespa

ART. **6103**

ADESIVA in plastical/plastic ADHESIVE
(Sim. 241012-197601)

VESPA PX - PX ARCOBALENO

vespa

ART. **6100**

(interasse fra pioli / wheelbase between pins **mm. 55**)
(Sim. 195629)

VESPA PK e PK XL

vespa

ART. **6101-A**

(con parte azzurra)
(Sim.198184)

VESPA PK-PK AUTOMATICA-PK 80 S-PK 125 S-P125 ETS

TARGHETTE POSTERIORI

REAR NAMEPLATES



vespa 50

ART. **5754** (Sim. 152509)

vespa 50s

ART. **5755** (Sim. 152510)

50 special

ART. **5756** (Sim. 152511)

vespa 90

ART. **5759** (Sim. 145341)

125 primavera

ART. **5757** (Sim. 145340)

ET3

ART. **5762** (Sim. 158562)

125 g.t.r.

ART. **5760** (Sim.152514)

150 super

ART. **5765** (Sim.152513)

150 sprint v.

ART. **5764** (Sim.145342)

rally 200

ART. **5766** (Sim.152515)

RALLY 200

ART. **5767** (Sim.141828)



TARGHETTE COFANO LATERALE

SIDEPANEL NAMEPLATES

<p>ART. 5768 (Sim. 181327)</p>	<p>ART. 5770 (Sim. 182117)</p>	<p>ART. 5769 (Sim. 181328)</p>	
<p>ART. 5768-A (Sim. 194717)</p>	<p>ART. 5770-A (Sim. 194718)</p>	<p>ART. 5769-A (Sim. 195641)</p>	
<p>ART. 10000 (Sim. 241316)</p>	<p>ART. 5771 (Sim. 182895)</p>	<p>ART. 5789 (Sim. 198180)</p>	<p>ART. 5790 (Sim. 198181)</p>
<p>ART. 5791 (Sim. 189182)</p>	<p>ART. 5792 (Sim. 198183)</p>	<p>ART. 5795-L</p>	<p>ART. 10485 (Sim. 575795)</p>
<p>ART. 10486 (Sim. 575795)</p>	<p>ART. 6104 (Sim. 195630)</p>	<p>ART. 6105 (Sim. 195631)</p>	<p>ART. 6108 (Sim. 195635)</p>
<p>ART. 10018 (Sim. 227488)</p>	<p>ART. 10019 (Sim. 227562)</p>	<p>ART. 6111 (Sim. 256452)</p>	<p>ART. 6125-E (Sim. 198199)</p>
<p>ART. 6126-E (Sim. 198201)</p>	<p>ART. 6109 (Sim. 196459)</p>	<p>ART. 6123 (Sim. 198185)</p>	



ART. **5748**

MOLLETTA ELASTICA
PER FISSAGGIO TARGHETTE IN ALLUMINIO TUTTI TIPI

ELASTIC SPRING
FOR FIXING ALL MODELS OF ALLUMINUM NAMEPLATE

(Sim. 008108)





FREGI
ORNAMENTS



ART. **3380**

SR. COMPLETA FREGI PER SACCHE E PARAFANGO

COMPLETE SET OF ADHESIVE ORNAMENTS
FOR BODY SIDES AND MUDGUARD

VESPA 125 PRIMAVERA ET3

(Sim. 610194M)

TARGHETTE PARAFANGO ANT.
FRONT MUDGUARD NAMEPLATES

VESPA
AUTOMATICA



ART. **10477**

TARGHETTA "LX" ADESIVA RESINATA PER PARAFANGO ANTERIORE

(Sim. 656026)

FRONT MUDGUARD NAMEPLATE "LX" (ADHESIVE RESIN)

mm.13x15

VESPA LX 2T 50 (09-13) - 4T-4V 50 (09-13) - LX 2T TOURING & 30KM 50 (10-13)
LX 4T-4V TOURING 50 (10-13) - LX 4T FL 125/150 (2009) - LX EU3 IE 125/150 (09-11)
LX 4T EU3 TOURING 125 (10-11) - 4T 3V IE - TOURING 125/150 (12-13)
LX TOURING 150 (10-12) - LT 4T 3V IE 150 (2014)



ART. **10478**

TARGHETTA "S" ADESIVA RESINATA PER PARAFANGO ANTERIORE

(Sim. 654821)

FRONT MUDGUARD NAMEPLATE "S" (ADHESIVE RESIN)

mm.13x15

VESPA GTS 4T IE SUPER 125 (09-16) - GTS 4T 3V SUPER IE 150 (14-15)
VESPA GTS SUPER 300 (08-16) - GTS SUPER SPORT 300 (10-13)
VESPA S 2T & COLLEGE 50 (07-12) S 4T-4V & COLLEGE 50 (08-12)
VESPA S 4T EU3 125 (07-08) - S 4T 3V IE 125 (2012)
VESPA S 4T IE & COLLEGE 125 (09-11) e 150 (09-12) - S 4T 150 (08-09)

VESPA AUTOMATICA

TARGHETTE NAMEPLATES

ART. 10470

TARGHETTA FRONTALE PICCOLA ADESIVA RESINATA CROMATA (656219-577082)

SMALL FRONT NAMEPLATE ADHESIVE RESIN CHROME



mm. 98

ET2 50 ('97-'05)-ET2 INIEZIONE 50 ('97-'00)-ET4 50 ('00-'05)-ET4 125 ('96-'02)-ET4 150 ('99-'02)
946 4T 3V ABS - 946 RED EMEA, APAC 125 (13-17)-ELETTRICA (18-19)-ELETTRICA 25KM/H
(19)-ELETTRICA MOTOCICLO (19)-GRANTURISMO EU3 125 (06-07)-GT 60 EU3 250 (06-07)
GTS-GTS SUPER IE ABS E4 (EMEA) 300 (16-18)-GTS 250 (05-14)-GTS 4T E4 ABS (EMEA) 150
(16-17)-GTS 4T IE SUPER 125 (09-16)-GTS HPE 4T/4V IE ABS E4 300 (19)-GTS IE & TOURING
300 (12-16)-GTS IE ABS E4 (EMEA) 125 (16-18)-GTS IE ABS E4 125 (19)-GTS IE ABS E4 ABS 4T
SUPER 125 (18-19)-GTS SUPER 300 (08-16)-GTS SUPER HPE 4T/4V IE ABS 300 (18-19)-GTS
SUPER IE 4T 3V AU,EX,JP,RI,T,V 150 (14-15)-GTV 125 (06-08)-GTV 250 (06-09)-GTV 4T NAVY
EU3 125 (2008)-GTV 4T NAVY EU3 250(07)-GTV SEI GIORNI IE E4 ABS (EMEA) 300 (17-19)-GTV
VIA MONTENAPOLIONE 300 (2010) LT 4T 3V IE 150 (14)-LX 125/150 (05-06)-LX 2T 50 (05-08/09-
13)-LX 2T TOURING & 30KM 50 (10-13)-LX 4T EU3 TOURING 125 (10-11)-LX 4T FL 125/150 ('09)
LX 4T-4V TOURING 50 (10-13)-LX EU3 125 /150(06-08)-LX EU3 IE 125/150 (09-11)-LX
PRIMAVERA 4T 3V IE 125 (13-17)-LX TOURING 150 (10-12)-LXV 2T 50 (06-09)-LXV 2T NAVY 50
(2008)-LXV 4T EU3 125 (06-09)-LXV 4T NAVY EU3 125 (07-08)-LXV IE 4T 125 (10-13)-
PRIMAVERA 2T 50 (13-17)-PRIMAVERA 4T 2V 25 KM/H 50 (14-17)-PRIMAVERA 4T 3V 25 KM/H
E4 50 (17-18) - PRIMAVERA 4T 3V E4 IGET ABS 125 (16-19)-PRIMAVERA 4T 3V IGET ABS
(EMEA) 150 (16-19)-PRIMAVERA 4T-3V 150 (13-16)-PRIMAVERA 4T-3V NOABS E4 50 (17-18)
PRIMAVERA 4T-4V NO ABS 50 (13-17)-PX 125-150-200('98-'01)-PX 30 ANNI 125('07-'08)
X EU2 125 ('01-'07)-PX 125 / 150 (11-17)-S 2T & COLLEGE 50 (07-12) - S 4T 150 (08-09)-S 4T 3V
IE 125 (2012) -S 4T EU3 125 (07-08)-S 4T IE & COLLEGE 125/150 (09-12)-S 4T-4V & COLLEGE
50 (08-12)-SPRINT 2T NOABS E2 50 (14-17)-SPRINT 4T 2V 25 KM/H 50 (14-17)-SPRINT 4T 3V 25
KM/H E4 50 (17-19)-SPRINT 4T 3V IE 125 (14-15) - SPRINT 4T 4V NOABS E2 EMEA 50 (14-17)
SPRINT 4T-3V E4 50 (17-19)- SPRINT IGET 4T 3V ABS (EMEA) 125 (16-19)

ART. 10470-BR

TARGHETTA FRONTALE PICCOLA ADESIVA RESINATA BRUNITA (Sim. 672060)

SMALL FRONT NAMEPLATE ADHESIVE RESIN BURNISHED



mm. 98

GTS 4T IE SUPER 125 (09-16)-GTS SUPER 300 (08-16)-GTS SUPER SPORT 300 (10-13)
S 4T-4V & COLLEGE 50 (08-12) - S 4T 3V IE 125 (2012)
SPRINT 4T 3V IE 150 (2015) - SPRINT SPORT 4T 3V IGET ABS 150 (16-19)

ART. 10471

TARGHETTA LATERALE GRANDE ADESIVA RESINATA CROMATA (656220 ex 577081)

BIG LATERAL NAMEPLATE ADHESIVE RESIN CHROME



mm. 150

ET2 50 ('97-'05)-ET2 INIEZIONE 50 ('97-'00)-ET4 50 ('00-'05)-ET4 125 ('96-'02) - ET4 150 ('99-'02)
GRANTURISMO EU3 125 (06-07)-GT 60 EU3 250 (06-07)-GTS-GTS SUPER IE ABS E4 (EMEA)
300 (16-18)-GTS 250 (05-14)-GTS 4T E4 ABS (EMEA) 150 (16-17)-GTS 4T IE SUPER 125 (09-16)
GTS HPE 4T/4V IE ABS E4 300 ('19)-GTS IE ABS E4 (EMEA) 125 (16-18)-GTS IE ABS E4 125
(19)-GTS IE ABS E4 ABS 4T SUPER 125 (18-19)-GTS SUPER 300 (08-16)-GTS SUPER HPE
4T/4V IE ABS 300 (18-19)-GTS SUPER IE 4T 3V 150 (14-15)-GTV 125 (06-08)-GTV 250 (06-09)
GTV 4T NAVY EU3 125 ('08)-GTV 4T NAVY EU3 250 ('07)-GTV SEI GIORNI IE E4 ABS (EMEA)
300 (17-19)-GTV VIA MONTENAPOLIONE 300 ('10)-LT 4T 3V IE 150 (2014)-LX 125/150 (05-06)
LX 2T 50 (05-08)-LX 2T TOURING & 30KM 50 (10-13)-LX 4T EU3 TOURING 125 (10-11)-LX 4T FL
125/150 ('09)-LX 4T-4V 50 (09-13)-LX 4T-4V TOURING 50 (10-13)-LX EU3 125/150 (06-08)-LX EU
IE 125/150 (09-11)-LX TOURING 150 (10-12)-LXV 2T 50 (06-09)-LXV 2T NAVY 50 ('08)-LXV 4T
EU3 125 (06-09)-LXV4T NAVY EU3 125 (07-08)-IE 4T 125 (10-13)-PX 125-150-200 ('98-'01)
PX 30 ANNI 125 ('07-'08)-PX EU2 125 ('01-'07)-PX 125 (11-17)-S 2T & COLLEGE 50 (07-12)-S 4T
4V & COLLEGE 50 (08-12)-S 4T EU3 125(07-08)-S4T IE & COLLEGE 125(09-11)-S4T 150(08-09)

ART. 10471-BR

TARGHETTA LATERALE GRANDE ADESIVA RESINATA BRUNITA (Sim. 672061)

BIG LATERAL NAMEPLATE ADHESIVE RESIN BURNISHED



mm. 150

GTS 4T IE SUPER 125 (09-16)- GTS SUPER 300 (08-16)-GTS SUPER SPORT 300 (10-13)
S 2T & COLLEGE 50 (07-12)-S 4T-4V & COLLEGE 50 (08-12)-S 4T 3V IE 125 (12)
SPRINT 2T NO ABS E2 50 (14-17)-SPRINT 4T 2V 25 KM/H 50(14-17)-4T 3V IE 125 (14-15)
SPRINT 4T 3V IE 150 (15)-SPRINT SPORT 4T 3V IGET ABS 150 (16-19)



TARGHETTE NAMEPLATES

VESPA AUTOMATICA



ART. 10472

TARGHETTA ADESIVA RESINATA CROMATA

(Sim. 656221)

ADHESIVE RESIN CHROME NAMEPLATE

VESPA LX 2T 50 ('09-'13) - LX 2T TOURING 50 (10-'13)
VESPA LX 4T 50 ('05-'08) - LX 4T-4V TOURING 50 ('10-'13)



ART. 10467

TARGHETTA "SPRINT" PICCOLA (mm.60)

(Sim. 1B001263)

RESINATA ADESIVA CROMATA X SCUDO ANTERIORE

FRONT NAMEPLATE, SMALL mm.60 (ADHESIVE RESIN CHROME)

VESPA SPRINT 4T 2V 25 KM/H 50 (14-17) - 4T 3V 25 KM/H E4 50 (17-20)
SPRINT 2T NO ABS E2 50 (14-17) - 4T 4V NOABS E2 EMEA 50 (14-17)
SPRINT 4T-3V E4 50 (17-20) - 4T 3V IE 125 (14-15) - IGET 4T 3V ABS (EMEA) 125 (16-20)



ART. 10467-BR

TARGHETTA "SPRINT" PICCOLA (mm.60)

(Sim.2H000928)

ADESIVA BRUNITA X SCUDO ANTERIORE

FRONT NAMEPLATE, SMALL mm.60 (ADHESIVE BURNISHED)

VESPA SPRINT 2T NO ABS E2 50 (14-17) - 4T 2V 25 KM/H 50 (14-17)
SPRINT 4T 3V IE 125 (14-15) - 4T 3V IE 150 (2015) - SPORT 4T 3V IGET ABS 150 (16-19)



ART. 10468

TARGHETTA "SPRINT" GRANDE (mm.115)

(Sim.1B000943)

RESINATA ADESIVA CROMATA LATERALE

LATERAL NAMEPLATE, BIG TYPE mm.115 (ADHESIVE RESIN CHROME)

VESPA SPRINT 4T 2V 25 KM/H 50 (14-17) - 4T 3V 25 KM/H E4 50 (17-20)
25 KM/H E5 50 (2020) - 2T NO ABS E2 50 (14-17) 4T 4V NO ABS E2 EMEA 50 (14-17)
4T 3V E5 50(2020)-4T-3V E4 50(17-20)-4T 3V IE 125(14-15)-4T 3V ie ABS E5 125(20-21)
IGET 4T 3V ABS (EMEA) 125 (16-20)-RACING SIXTIES ABS E5 150 (2021)
SPORT 4T 3V IGET ABS 150 (16-19) - SPORT ABS E5 150 (2020)



ART. 10468-BR

TARGHETTA "SPRINT" GRANDE (mm.115)

(Sim.2H000927)

ADESIVA BRUNITA LATERALE

LATERAL NAMEPLATE, BIG TYPE mm.115 (ADHESIVE BURNISHED)

VESPA SPRINT 2T NO ABS E2 50 (14-17) - 4T 2V 25 KM/H 50 (14-17)-4T 3V IE 125 (14-15)
SPRINT 4T 3V IE 150 (2015) - SPORT 4T 3V IGET ABS 150 (16-19)



ART. 10462

TARGHETTA LATERALE "PRIMAVERA" RESINATA ADESIVA CROMATA (1B000942)

LATERAL NAMEPLATE, (ADHESIVE RESIN CHROME)

VESPA PRIMAVERA 4T 2V 25 KM/H 50 (14-17) - 4T 3V 25 KM/H E4 50 (17-19)
PRIMAVERA 25 KM/H E5 50 (20-21) - 2T 50 (13-17) - 4T 3V E5 50 (20-21)
PRIMAVERA 4T-3V NO ABS E4 50 (17-20) - 4T-4V NO ABS 50 (13-17)
LX PRIMAVERA 4T 3V IE 125 (13-17) - 4T 3V E4 IGET ABS 125 (16-20)
PRIMAVERA 4T 3V IE ABS E5 125 (20-21)
PRIMAVERA 150 E5 150 (20-21) - 4T-3V 150 (13-16)
PRIMAVERA 4T 3V IGET ABS (EMEA) 150 (16-20)

STATORI STATORS

VESPA ET3 125 (1976-1983)



ART. **9166**

STATORE

VESPA ET3 125 ('76-'83)

(Sim. 186974)

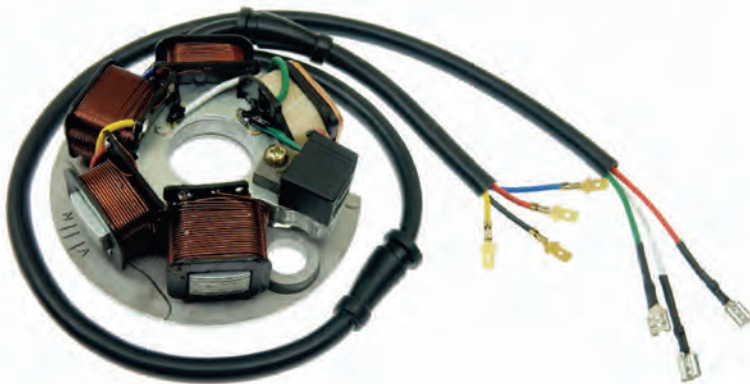

ART. **9166-E1**

STATORE

VESPA ET3 125 ('76-'83)

(Sim. 186974)

VESPA PK 50 XL - RUSH - N CON AVVIAMENTO A PEDALE / *WITHOUT ELECTRIC START*

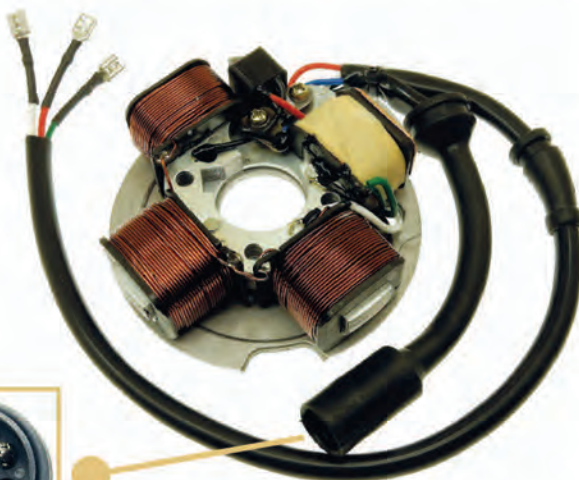

ART. **9154-E1**

STATORE

VESPA PK 50 XL - RUSH - N

CON AVVIAMENTO A PEDALE
(SENZA AVVIAMENTO ELETTRICO)

*WITHOUT ELECTRIC START
WITH PEDAL START*

(Sim. 234321)





STATORI

STATORS

VESPA PK 50 SENZA AVVIAMENTO ELETTRICO E SENZA FRECCE
WITHOUT ELECTRIC STARTER AND WITHOUT INDICATOR LENSES

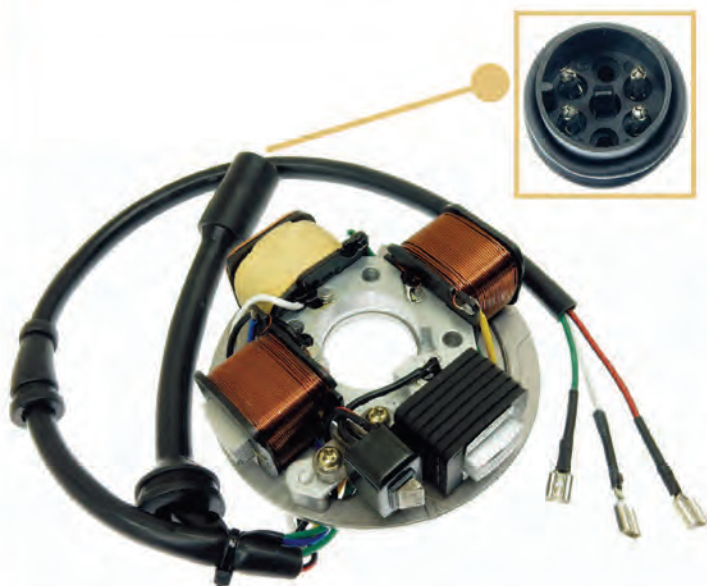

ART. **9155-E1**

STATORE

VESPA PK 50

MODELLI SENZA AVVIAMENTO ELETTRICO
E SENZA FRECCE

MODELS WITHOUT ELECTRIC STARTER
AND WITHOUT INDICATOR LENSES

(Sim. 199491-199481)

VESPA PK 50/125 (1982-1984)

APE FL- FL2 50 (1989-1995) - APE FL3 EUROPA 50 (1996-1999) - APE RST MIX 50 (1999-2003)



ART. **9161**

STATORE

Nr.3 FILI FASTOM
Nr.5 ATTACCHI NEL CONNETTORE

No. 3 FASTOM WIRES
No. 5 ATTACKS IN CONNECTOR

(Sim. 497651 - 199500)

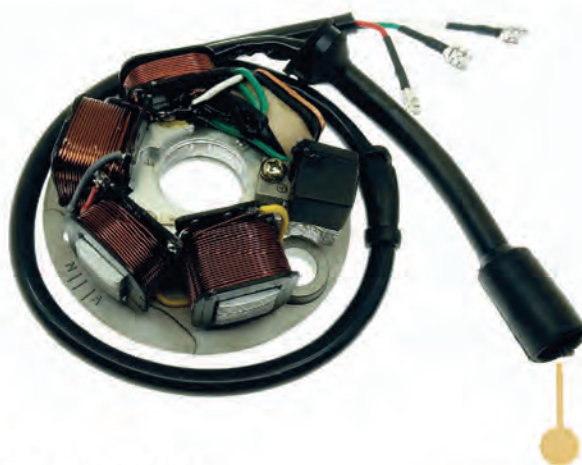

ART. **9161-E1**

STATORE

Nr.3 FILI FASTOM
Nr.5 ATTACCHI NEL CONNETTORE

No. 3 FASTOM WIRES
No. 5 ATTACKS IN CONNECTOR

(Sim. 497651 - 199500)

STATORI

STATORS

VESPA FL 50 - FL 125 - N 50 - PK 50/125 - PK XL 50/125 - RUSH 50
APE TM P 50

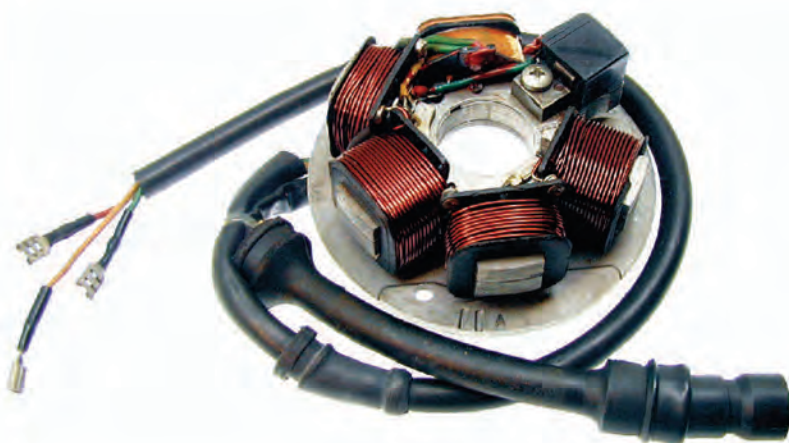

ART. 9162-E

STATORE

Nr.3 FILI FASTOM
Nr.3 ATTACCHI NEL CONNETTORE

No. 3 FASTOM WIRES
No. 3 ATTACKS IN CONNECTOR

VESPA FL 50	(1990)
VESPA FL 125	(1989-1990)
VESPA N 50	(1989-1990)
VESPA PK 50-125	(1982-1984)
VESPA PK XL 50	(1985-1988)
VESPA PK XL 125	(1986-1989)
VESPA RUSH 50	(1988-1989)
APE TM P 50	(1985-1989)

(Sim.497654-199495V)

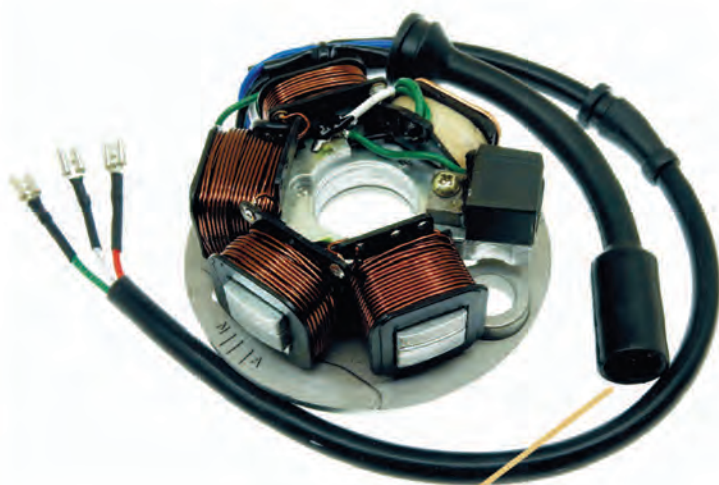

ART. 9162-E1

STATORE

Nr.3 FILI FASTOM
Nr.3 ATTACCHI NEL CONNETTORE

No. 3 FASTOM WIRES
No. 3 ATTACKS IN CONNECTOR

VESPA FL 50	(1990)
VESPA FL 125	(1989-1990)
VESPA N 50	(1989-1990)
VESPA PK 50-125	(1982-1984)
VESPA PK XL 50	(1985-1988)
VESPA PK XL 125	(1986-1989)
VESPA RUSH 50	(1988-1989)
APE TM P 50	(1985-1989)

(Sim.497654-199495V)



STATORI STATORS

VESPA 125 T5



ART. **9168**

STATORE Ø mm.95

VESPA 125 T5

(Sim. 232172)

VESPA PX 125/150/200E ARCOBALENO - VESPA COSA

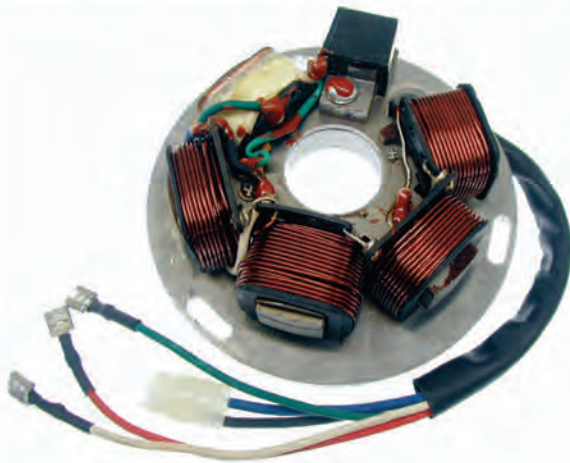

ART. **9160**

STATORE

Nr. 5 FILI / No. 5 WIRES

VESPA PX 125 - 150 - 200E ARCOBALENO
VESPA COSA

(Sim. 497652-217866)

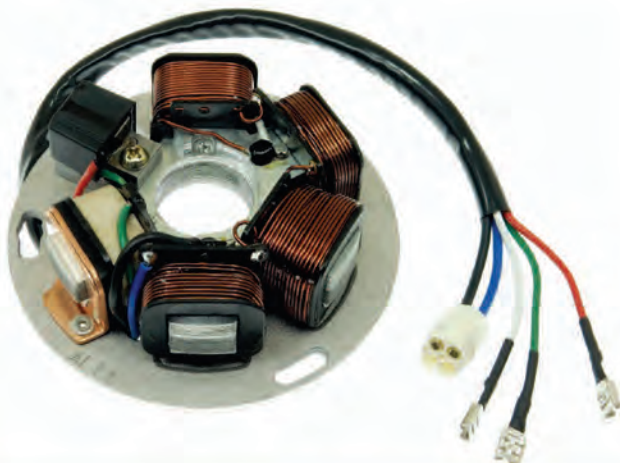

ART. **9160-E1**

STATORE

Nr. 5 FILI / No. 5 WIRES

VESPA PX 125 - 150 - 200E ARCOBALENO
VESPA COSA

(Sim. 497652-217866)

STATORI

STATORS

VESPA PX 125/150/200E ARCOBALENO AVVIAMENTO ELETTRICO / *ELECTRIC STARTER*

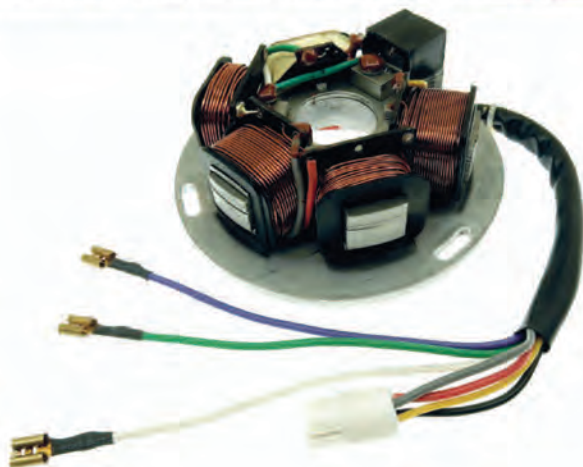

ART. **9165**

STATORE

N. 7 FILI / No. 7 WIRES

VESPA PX 125 - 150 - 200E versione ARCOBALENO
(VNX2 - VLX1 - VSX1)

CON AVVIAMENTO ELETTRICO
WITH ELECTRIC STARTER

DAL 1983 AL 1987

(Sim. 217983)

VESPA LML MOTORI 125/150 2T SENZA AVVIAMENTO ELETTRICO *WITHOUT ELECTRIC STARTER*

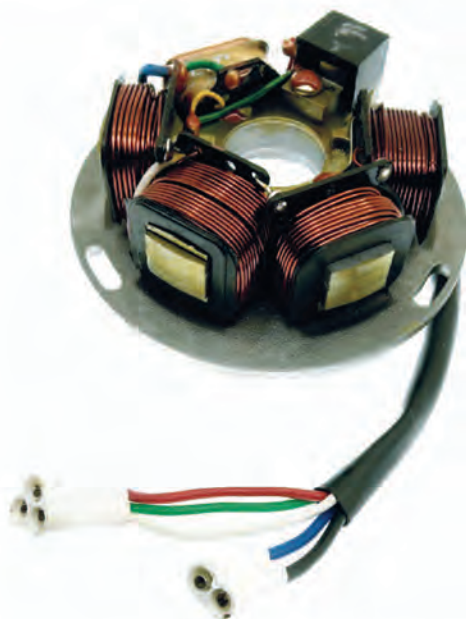

ART. **9149**

STATORE POTENZA 80W

VESPA LML MOTORI 125/150 2T
SENZA AVVIAMENTO ELETTRICO
WITHOUT ELECTRIC STARTER

(Sim. C4707473)

VESPA ET2

SCOOTER PIAGGIO / GILERA 50 cc.



ART. **9159**

STATORE

VESPA ET2 (1997-2005)

SCOOTER PIAGGIO

FREE FL 50 ('95-'02) - FREE DELIVERY 50 ('00-'01)
LIBERTY 50 ('97-'02)
NRG 50 ('94-'96) - RST MC2 50 ('96-'98)
NRG EXTREME 50 ('99-'00) - NRG MC3 50 ('01-'03)
NTT 50 ('95-'96) - QUARTZ 50 ('92-'96)
SFERA 50 ('91-'93) - SFERA RST 50 ('95-'97)
SKR CITY 80 ('99)
ZIP 50 ('92-'96) - RST 50 ('96-'99) -
FAST RIDER RST 50 ('96-'97) - ZIP SP 50 ('96-'00)

SCOOTER GILERA

EASY MOVING 50 ('95-'96) - RUNNER 50 ('97-'00)
STALKER 50 ('97-'02) - STORM 50 ('94-'95)
TYPHOON 50 ('94-'97) - X 50 ('98-'99) - XR 50 ('00)

(Sim. 830294)



VENTOLA VOLANO

FLYWHEEL FUN



CORONA z 93



ART. **9152**

VENTOLA VOLANO

VESPA PX 125-150
VESPA PXE ARCOBALENO DAL 1984->

CON AVVIAMENTO ELETTRICO
WITH ELECTRIC START

(Sim.1794993)

MOTORINI AVVIAMENTO

STARTING MOTORS



ART. **8997-E1**

MOTORINO AVVIAMENTO

VESPA PK XL 50 ('84-'88)
PK 50-125 ('82-'84)
PK S 50 E 125 AUTOMATICA ('84-'89)
RUSH 50 ('88-'89) - N 50 ('89-'90)
FL 50 ('90) - FL 125 ('89-'90)
FL2 HP ('91-'97) - FL2 AUTOMATICA 50 ('90-'91)

APE TM P 50 ('85-'89) - FL - FL2 50 ('89-'95)
APE FL3 EUROPA 50 ('96-'99)
APE RST MIX 50 ('99-'03)

(Sim. 179116.5)



ART. **8998-E1**

MOTORINO AVVIAMENTO

VESPA PX 125-150-200 ('98-'01)
PX EU2 125 ('01-'07)
PX 30 ANNI 125 ('07-'08)
PXE ARCOBALENO 125-150-200 ('81-'97)
VESPA COSA CL-CLX 125-150-200 ('88-'91)

(Sim. 249235)

RICAMBI MOTORINI AVVIAMENTO

STARTING MOTORS SPARE PARTS

VESPA PXE ARCOBALENO 125-150-200 ('81-'97) - PK XL 50 ('85-'88) - PK XL RUSH 50 ('88-'89) - PK XL 125 ('86-'89)
 VESPA PK 50-125 ('82-'84) - PK 50 S 50-125 AUTOMATICA ('84-'89) - PK XL PLURIMATIC 50 ('85-'90) - N 50 ('89-'90)
 VESPA FL 50 ('90) - FL 125 ('89-'90) - FL2 HP 50 ('91-'97) - FL2 AUTOMATICA 50 ('90-'91)
 VESPA COSA 2 125-150-200 ('91-'97) - COSA CL/CLX 125-150-200 ('88-'91)
 APE TM P 50 ('85-'89) - APE FL - FL2 50 ('89-'95) - APE FL3 EUROPA 50 ('96-'99) - APE RST MIX 50 ('99-'03)



ART. **7112-KT**

KIT RUOTA LIBERA COMPLETA PER REVISIONE MOTORINO AVVIAMENTO

STARTING PINION COMPLETE KIT

(Sim. 248293+249482)



ART. **7112**

RUOTA LIBERA MOTORINO AVVIAMENTO

STARTING PINION

(Sim.248293)



ART. **7110**

KIT REVISIONE MOTORINO AVVIAMENTO

OVERHAULING PINION

(Sim.249482)



ART. **9157**

ANELLO PORTASPAZZOLE COMPLETO DI SPAZZOLE (MONTA SU MOTORINI AVVIAMENTO DI ORIGINE NAZIONALE)
RING BRUSH HOLDER

(Sim. 291383)



RICAMBI ELETTRICI

ELECTRIC SPARTE PARTS



ART. 7135-HQ

GENERATORE CORRENTE / PICK UP **HIGH QUALITY**

VESPA PX - PXE ARCOBALENO 125-150-200 - 125 T5 - PK XL - PK 50-125
RUSH - N - FL - FL2 - HP - VESPA COSA CL/CLX 125-150-200
APE TM P 50 - APE FL - FL2 - FL3 EUROPA - APE MIX - RST

(Sim. 196549 ex 181370)



ART. 7134

GENERATORE CORRENTE / PICK-UP

VESPA RALLY 200

(Sim.127254)

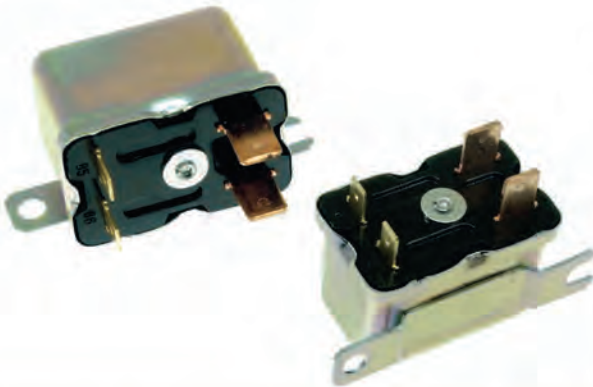

ART. 7131

TELERUTTORE AVVIAMENTO / REMOTE CONTROL SWITCH

VESPA PXE ARCOBALENO 125-150-200 ('81-'97) - T5 125 ('85-'89)
PK XL 50 ('85-'88) - PK XL RUSH 50 ('88-'89) - PK XL 125 ('86-'89)
PK 50-125 ('82-'84) - PK 50 S 50-125 AUTOMATICA ('84-'89)
PK XL PLURIMATIC 50 ('85-'90) - N 50 ('89-'90) - FL 50 ('90)
FL 125 ('89-'90) - FL2 HP 50 ('91-'97) - FL2 AUTOMATICA 50 ('90-'91)
VESPA COSA 2 125-150-200 ('91-'97)-CL/CLX 125-150-200 ('88-'91)
APE TM P 50 ('85-'89) - FL - FL2 50 ('89-'95) - FL3 EUROPA 50 ('96-'99)
APE TM P 703 / P703 V DIESEL 420 ('87-'01)-CAR - MAX DIESEL 420 ('86-'96)
APE POKER BENZINA 420 ('93) - POKER DIESEL 420 ('93-'97)
PIAG.SFERA 125 ('95-'97) - SKIPPER 125-150 ('94-'97)-HEXAGON 125-150('94-'97)
GILERA TYPHOON 125 ('95-'98)

(Sim.218824)



ART. 7130-E1

TELERUTTORE AVVIAMENTO / STARTER REMOTE SWITCH

VESPA ET2 50 - ET4 125 - GRANTURISMO 125-200 - GT 250
VESPA GTS 125-250-300- GTV 125-250-300 - VESPA LX 2T / 4T 50
VESPA LX 4T 125 - LX EU3 125-150 - VESPA LXV 2T 50 - LXV 4T 125
VESPA LX PRIMAVERA 125 - PRIMAVERA 2T/4T 50-125
VESPA PX 125-150-PX 30 ANNI 125-VESPA S 2T 50 - S 4T 125-150
VESPA SPRINT 2T/4T 50-125-150

APE 50 ('09)-APE MIX 2T 50 ('98-'08)-PORTER D120 E5 1200-
PORTER MULTITECH EU4-E45 1300 - PORTER PICK DIESEL 1400
PORTER UP-DATE 1300

SCOOTER APRILIA - GILERA - PIAGGIO

(Sim. 58115R)

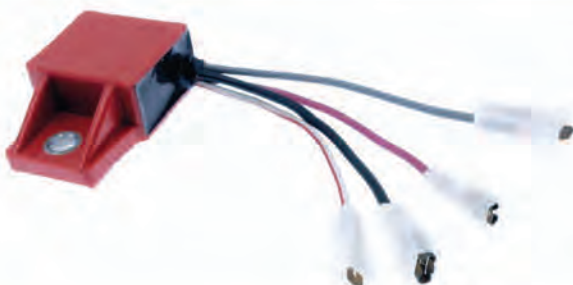

ART. 7147

CENTRALINA CONSENSO AVVIAMENTO / DEVICE, BLINKER

VESPA PX 125 DAL 1998
VESPA PX 150 DAL 2011
VESPA PX 30 ANNI 125 ('07-'08)
VESPA PX EU2 125 ('01-'07)

(Sim. 233707)

REGOLATORI DI TENSIONE

VOLTAGE REGULATORS



ART. 7140

REGOLATORE DI TENSIONE

VESPA PX 125-150 - PX 150 E - PX 200 E - VESPA PK 50 SS
VESPA PK 125 - 125 PRIMAVERA ET3

(Sim. 161639)



ART. 7140-E

REGOLATORE DI TENSIONE

VESPA PX 125-150 - PX 150 E - PX 200 E - VESPA PK 50 SS
VESPA PK 125 - 125 PRIMAVERA ET3

(Sim. 161639)



ART. 8983-E1

REGOLATORE DI TENSIONE 12-16A CC/CA

MODELLI CON AVVIAMENTO ELETTRICO
MODELS WITH ELECTRIC START :

VESPA PK 50 - FL -HP - N - VESPA PX-PE ARCOBALENO

SCOOTER PIAGGIO GILERA
SFERA - SFERA RST -ZIP - ZIP FAST RIDER - ZIP SP
FREE - NRG - NRG MC2 - NTT - QUARTZ TYPHOON - STORM ...

(Sim. 291931 -185824)



ART. 8980-E1

REGOLATORE DI TENSIONE 12V CA
CORRENTE ALTERNATA / ALTERNATING CURRENT

VESPA FL 50 ('90)-FL 125 ('89-'90)-N 50 ('89-'90)-PK XL 50 ('85-'88)
VESPA PK XL 125 ('86-'89) - RUSH 50 ('88-'89) - T5 125 ('85-'89)
VESPA PX 125-150-200 ('98-'01) - PX EURO2 125 (01-'07)
VESPA PX 30 ANNI 125 ('07-'08) - COSA2 125-150-200 ('91-'97)
COSA CL/CLX 125-150-200 AVVIAMENTO ELETTRICO ('88-'91)
ELECTRIC START

APE TM P50 ('85-'89)

(Sim. 58074R-230824)



ART. 8985

REGOLATORE DI TENSIONE 12V - 20A - CA

VESPA COSA CL/CLX 125-150-200 ('88-'91)
AVVIAMENTO A PEDALE / PEDAL START

(Sim. 252025.5)



ART. 8984-E1

REGOLATORE DI TENSIONE

VESPE AUTOMATICHE

APE 50 (09-17) - APE MIX 2T 50 (98-08) - APE RST MIX 50 (99-03)
SCOOTER : APRILIA - GILERA - PIAGGIO

(Sim.58096R - 82587R - 294878 - AP.8124648-8127154)



RICAMBI ELETTRICI ELECTRIC SPARE PARTS

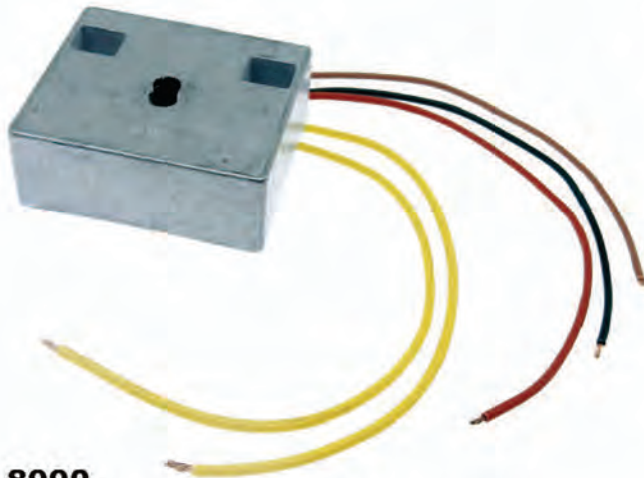

ART. **8990**

VESPA GS 150 - 160 DAL 1957 AL 1965

RADDRIZZATORE DI CORRENTE ALTERNATA-CONTINUA PER MANTENIMENTO CARICA DELLA BATTERIA
IN SOSTITUZIONE DEL RADDRIZZATORE ORIGINALE A LAMELLE

ALTERNATE-CONTINUE CURRENT RECTIFIER FOR MAINTAIN CHARGING THE BATTERY
IN REPLACEMENT OF THE ORIGINAL RECTIFIER AT SLATS

SCHEMA DI MONTAGGIO / ASSEMBLY SCHEME

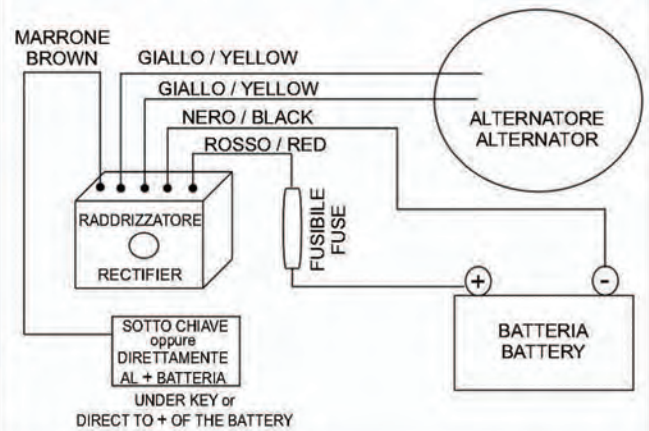

VESPA RALLY 200



ART. **7137**

CENTRALINA ELETTRONICA
IGNITION SYSTEM

VESPA RALLY 200 (Sim.124697)



ART. **9135**

SPIA LUCE VERDE MANUBRIO
GREEN LIGHT INDICATOR ON HANDLEBAR

VESPA RALLY (Sim. 146172)



ART. **7133**

RESISTENZA VALORE 250 OHM (Sim.104074)

VESPA RALLY 200 - APE MP 1ª SERIE
VOLANO CON CENTRALINA FEMSA TRONIC

RESISTANCE VALUE 250 OHM
VESPA RALLY 200 - APE MP 1ª SERIE
FLYWHEEL WITH ELECTRONIC CONTROL UNIT
FEMSA TRONIC



ART. **9122**

PULSANTE SPEGNI MOTORE
STOP ENGINE BUTTON

VESPA RALLY 200 (Sim. 73185)

CENTRALINE ELETTRONICHE

IGNITION SYSTEM



ART. **7146**

CENTRALINA ELETTRONICA / *IGNITION SYSTEM*

(Sim. 244128)

VESPA 125 PRIMAVERA ET3 - VESPA PX
VESPA PXE SERIE ARCOBALENO 125-150-200
VESPA PX 30 ANNI - VESPA T5 125
VESPA RALLY
VESPA PK TUTTI TIPI / *ALL MODELS*
APE 50



ART. **7146-E**

CENTRALINA ELETTRONICA / *IGNITION SYSTEM*

(Sim. 244128)



ART. **7143**

CENTRALINA ELETTRONICA / *IGNITION SYSTEM*

VESPA PK 50 - VESPA PK 50 XL -RUSH - N
APE TM 50
CICLOMOTORI PIAGGIO CIAO-BRAVO-SI'

(Sim. 244127)



ART. **7144**

DISPOSITIVO X LAMPEGGIATORI / *FLASHERS DEVICE*
6/12W C.A. - 10/21W C.A.

(Sim. 195703 - 213594)

VESPA PX 125-150 - PX EU2 - PXE ARCOBALENO
VESPA PX 30 ANNI - VESPA T5 125
VESPA PK TUTTI TIPI / *ALL MODELS*
VESPA COSA
APE P 50 ('80-'85) - APE TM P50 ('85-'89)
CIAO MIX - SI' MIX - SI' FL2 - GRILLO



ART. **7144-E**

DISPOSITIVO X LAMPEGGIATORI / *FLASHERS DEVICE*
6/12W C.A. - 10/21W C.A.

(Sim. 195703 - 213594)



ART. **7142**

BOBINA A.T. ESTERNA

OUTSIDE H.T. COIL

VESPA TUTTI TIPI / *ALL MODELS*
CICLOMOTORI PIAGGIO CIAO - SI'

(Sim. 244114)



BOBINE ACCENSIONE ESTERNA

EXTERNAL H.T. COILS

IN BACHELITE



ART. 7070-P

IN BACHELITE / BAKELITE
VERSIONE **POTENZIATA**
BOOSTED VERSION

VESPA 150 ('55->'58)
VESPA GL ('57->'58)

(Sim.022692)



ART. 7072-P

IN BACHELITE / BAKELITE
VERSIONE **POTENZIATA**
BOOSTED VERSION

VESPA 150 ('59->'65) - GL ('59->'64)
APE 175D - 150E

(Sim.93734)



ART. 7071-P

IN BACHELITE / BAKELITE
VERSIONE **SUPER POTENZIATA**
MORE BOOSTED VERSION

VESPA 180 SS
VESPA RALLY 180



ART. 7074-P

IN BACHELITE / BAKELITE
VERSIONE **SUPER POTENZIATA**
MORE BOOSTED VERSION

(Sim. 23943)

CON GOMMINO PROTEZIONE CAVO CANDELA **TIPO ALTO**
CAVO CANDELA **RIVESTITO CON GUAINA**

RAISED CAP , SPARK PLUG PROTECTION CABLE
SPARK PLUG CABLE COVERED WITH SHEAT

VESPA **GS 150** (VS1T ->VS5T) (1955->1961)



ART. 7075-P

IN BACHELITE / BAKELITE
VERSIONE **SUPER POTENZIATA**
MORE BOOSTED VERSION

CON GOMMINO PROTEZIONE CAVO CANDELA **TIPO ALTO**
CAVO CANDELA **RIVESTITO CON GUAINA**

RAISED CAP , SPARK PLUG PROTECTION CABLE
SPARK PLUG CABLE COVERED WITH SHEAT

VESPA **GS 160** (VSB1T) (1962->1965)



ART. 7073

LAMBRETTA LI 150

(Sim.326106)

CAPPUCCI / CAVI CANDELA

PROTECTIONS / SPARK PLUG CABLES

ART. 7123-K

TRIS CAPPUCCI ELETTRICI
ELECTRICAL PROTECTION SET

VESPA GS 160 - VESPA 180 SS



ART. G0822

CAPPUCCIO BASSA TENSIONE
CAP LOW VOLTAGE

(Sim. 161125)

VESPA 50-90-125 - APE 50



ART. G0605

GOMMINO PASSACAVI
STATORE VOLANO MAGNETE
GROMMET STATOR FLYWHEEL MAGNET

(Sim.46766)

VESPA 50 ('67-'82) - 125 ('55-'65) - PK 50 ('82-'84)
APE P 50 ('80-'85) - TM P 50 ('85-'89)



ART. 9126

ATTACCO CANDELA A FORCELLA
SPARK PLUG ATTACK



ART. G0849

CAPPUCCIO CANDELA
SPARK PLUG CAP

(Sim. 244395 ex 072843)

VESPA 50 - 90 - 125 PRIMAVERA - ET3 - PK-PK XL
VESPA RUSH - FL-FL2 HP - PX 125 - PX EU2 125
VESPA COSA CL-CLX
APE 50 - 50 FL/FL2 - MIX 2T 50 - P50 - RST MIX 50 - TM P 50



ART. G0659

CAPPUCCIO CANDELA
SPARK PLUG CAP

(Sim. 46741)

VESPA 125-150 - P125X-P150X - PX PE ARCOBALENO



ART. 7120

CAPPUCCIO PROTEZIONE BOBINA
RUBBER CAP, IGNITION COIL

(Sim. 048525)

VESPA 150 (VBBA1T - VBB12T)
VESPA GL 150 (VLA1T) - RALLY 180 (VSD1T)



ART. 7122

CAPPUCCIO BOBINA ALTA TENSIONE
RUBBER CAP, IGNITION COIL

(Sim. 022694)

VESPA 150 (VL1/2/3)-(VB1)-(GL1)
VESPA GS 150 (VS1->VS5)



ART. 9120-D5

CAVO CANDELA MORBIDO - Ø mm. 5 - COLORE NERO
SPARK PLUG CABLE, Ø mm. 5, BLACK IN SOFT MATERIAL

(confezione/pack mt. 5)



ART. 9120-D7

CAVO CANDELA - CLASSE E - Ø mm. 7 -
SCHERMATO IN SILICONE COLORE NERO

SPARK PLUG CABLE, CLASS E, Ø mm. 7
COPPER SILICONE BLACK COLOUR

VESPA TUTTI TIPI / ALL MODELS

(confezione/pack mt. 5)

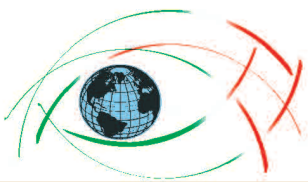

CONTATTI

CONTACTS POINT



ART. 9091

CONTATTO

VESPA 50 - 50 SPECIAL
VESPA 50 R - 50 S

(Sim. 101761)

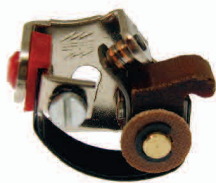

ART. 9092

CONTATTO

VESPA 90 - 125 PRIMAVERA - ET3
APE 50 - APE 250 dal '70 al '74

(Sim 141838)



ART. 9089

CONTATTO

VESPA PX PRIME SERIE
SUPER e SPRINT dal '74
(Imianti con la bobina)

(Sim. 140963)



ART. 9093

CONTATTO

VESPA PX 125 - PX 150

(Sim 134117 - 182342)



ART. 9088

CONTATTO

VESPA SPRINT e SUPER 1971

(Sim.129434)



CONDENSATORI

CONDENSERS



ART. 9097

CONDENSATORE **CON STAFFA**
CONDENSER **WITH BRACKET**

VESPA 50
(V5A1T FINO AL TELAIO/TILL CHASSIS TO 76350)

VESPA 90 - 90SS
VESPA NUOVA 125 1965
VESPA PRIMAVERA 125 (VMA)
APE 50 - APE 250

(Sim. 79697)



ART. 9098

CONDENSATORE

VESPA PX 125 - 150

(Sim. 182343)



ART. 9097-SS

CONDENSATORE **SENZA STAFFA**
CONDENSER **WITHOUT BRACKET**

VESPA 50SS - 50R
(V5A1T DAL TELAIO/FROM CHASSIS 853411)

VESPA 50 SPECIAL
(V5B1T DAL TELAIO/FROM CHASSIS 70567)

VESPA 50 SPECIAL (V5B3T)

(Sim. 78937)



ART. 9095

CONDENSATORE
DOPPIO FILO
DOUBLE WIRE

VESPA SPRINT
VESPA SUPER

(Sim. 155973)





CONDENSATORI RINFORZATI

REINFORCED CONDENSERS

EFFICIENZA E AFFIDABILITA' GARANTITA AL 100%
EFFICIENCY AND RELIABILITY 100% GUARANTEED



ART. **9030**

CONDENSATORE **RINFORZATO** - Made in Italy

CAPACITA' ELETTRICA / ELECTRICAL CAPACITY (MICROFARAD uF 0,32)
LUNGHEZZA CAVO GIALLO / LENGHT YELLOW CABLE cm.12
Ø OCCHIELLO / EYELET mm. 3

VESPA 50 (V5A1) (V5SA1) - 50N (V5A1) (V5SS1/2) - 50 L (V5A1) (VSB2/3)
VESPA 50 R (V5A1 dal/since 853411) - 50 SPECIAL (V5B1 dal/since 70577)
VESPA 98 (V98) - VESPA 125 (V1/15) - VESPA 125 (V30/33)



ART. **9031**

CONDENSATORE **RINFORZATO** - Made in Italy

CAPACITA' ELETTRICA / ELECTRICAL CAPACITY (MICROFARAD uF 0,34)
LUNGHEZZA CAVO GIALLO / LENGHT YELLOW CABLE cm.13
Ø OCCHIELLO / EYELET mm. 3

VESPA 125 (VU1) - 125 (VM1/2) - 125 (VN1/2) - 150 (VL1/3)
VESPA 150 (VB1) - GS 150 (VS1/5) - GS 160 (VSB1) - 180 SS (VSC1)
APE 50 (1969-1971) - APE 150 (1953-1958)



ART. **9032**

CONDENSATORE **RINFORZATO** - Made in Italy

CAPACITA' ELETTRICA / ELECTRICAL CAPACITY (MICROFARAD uF 0,34)
LUNGHEZZA CAVO GIALLO / LENGHT YELLOW CABLE cm.13
Ø OCCHIELLO / EYELET mm. 3
LUNGHEZZA CAVO ROSSO / LENGHT RED CABLE cm. 28
Ø OCCHIELLO / EYELET mm. 3

VESPA 125 (VNA1/2) - 125 (VNB1/6) - 125 SUPER (VNC1)
VESPA 150 (VBB2 dal/since 216489) - GL 150 (VLA dal/since 70722)
VESPA SPRINT 150 (VLB1) - RALLY 180 (VSD1)
APE 150 (1959-1962)



ART. **9033**

CONDENSATORE **RINFORZATO** - Made in Italy

CAPACITA' ELETTRICA / ELECTRICAL CAPACITY (MICROFARAD uF 0,32)
LUNGHEZZA CAVO GIALLO / LENGHT YELLOW CABLE cm.13
Ø OCCHIELLO / EYELET mm. 3
LUNGHEZZA CAVO ROSSO / LENGHT RED CABLE cm. 28
Ø OCCHIELLO / EYELET mm. 3

VESPA GT 125 (VNL2) - GTR 125 (VNL2) - TS 125 (VNL3)
VESPA SUPER 150 (VBC1) - SPRINT VELOCE 150 (VLB1)
APE C150 (AC1T/4T) (1953-1967)



CONDENSATORI RINFORZATI

REINFORCED CONDENSERS

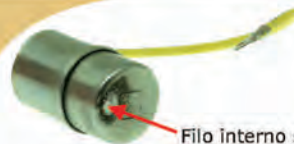

Filo interno saldato all'involucro
inner wire welded to the casing

EFFICIENZA E AFFIDABILITA' GARANTITA AL 100%
EFFICIENCY AND RELIABILITY 100% GUARANTEED



ART. **9034**

CONDENSATORE **RINFORZATO** - Made in Italy

CAPACITA' ELETTRICA / ELECTRICAL CAPACITY	(MICROFARAD uF 0,32)
LUNGHEZZA CAVO GIALLO / LENGHT YELLOW CABLE	cm.13
Ø OCCHIELLO / EYELET	mm. 3
LUNGHEZZA CAVO ROSSO / LENGHT RED CABLE	cm. 34
Ø OCCHIELLO / EYELET	mm. 5

VESPA 150 (VBA1) (VBB1) - 150 (VBB2 fino al telaio / till to chassis 216488)
VESPA GL 150 (VLA1 fino al telaio / till to chassis 70721)
APE D 175 (AD1T/2) (1964-1974)



ART. **9035**

CONDENSATORE **RINFORZATO** - Made in Italy

CAPACITA' ELETTRICA / ELECTRICAL CAPACITY	(MICROFARAD uF 0,32)
LUNGHEZZA CAVO GIALLO / LENGHT YELLOW CABLE	cm.12
Ø OCCHIELLO / EYELET	mm. 3
LUNGHEZZA CAVO ROSSO / LENGHT RED CABLE	cm. 28
FASTON MASCHIO	4,8 mm.

VESPA P125X - P150X (6V senza frecce / without indicator lensens)
APE P401 - APE 500



ART. **9037**

CONDENSATORE **RINFORZATO** - Made in Italy

CAPACITA' ELETTRICA / ELECTRICAL CAPACITY	(MICROFARAD uF 0,22)
LUNGHEZZA CAVO GIALLO / LENGHT YELLOW CABLE	cm.12
Ø OCCHIELLO / EYELET	mm. 3

VESPA 50 (V5A2) - 50R (V5A1 fino al telaio / till to chassis 853410)
VESPA 50 SPECIAL (V5B1 fino al telaio / till to chassis 70576)



ART. **9038**

CONDENSATORE **RINFORZATO** - Made in Italy

CAPACITA' ELETTRICA / ELECTRICAL CAPACITY	(MICROFARAD uF 0,32)
LUNGHEZZA CAVO GIALLO / LENGHT YELLOW CABLE	cm.12
Ø OCCHIELLO / EYELET	mm. 3

VESPA 90 (V9A1) - 90 SS (V9SS1) - VESPA NUOVA 125 (VMA1)
VESPA 125 PRIMAVERA (VMA2)
APE 50 (TL1T) (1969-1971)
APE A 125 (A1T/A15T) (1947-1952) - APE B 150 (AB1T/4T) (1953-1956)

BOBINE ACCENSIONE INTERNA

INTERNAL H. T. COILS



ART. 7085

VESPA 50 1ª SERIE

(Sim.98361-98360)

(interasse fori d'attacco mm. 58)
(wheelbase hole connection mm. 58)



ART. 7080

VESPA 50 2ª SERIE

(Sim.111820)

(interasse fori d'attacco mm. 58)
(wheelbase hole connection mm. 58)



ART. 7081

(DOPPIO ISOLAMENTO)
(DOUBLE INSULATION)

VESPA 50

(interasse fori d'attacco mm. 58)
(wheelbase hole connection mm. 58)



ART. 7086

VESPA 98 - VESPA 125 (V1T- V11->V15) - VESPA 125 (V30->V33) (FINO AL 1953)

(Sim. 000670-20838)

(interasse fori d'attacco / wheelbase hole connection mm.42,7)



ART. 7084

per volano 6 poli / for flywheel 6 poles

VESPA ('53->'57) - APE ('53->'57)

(Sim.16423)

(interasse fori d'attacco / wheelbase hole connection mm. 42,7)



ART. 7082

per volano 6 poli / for flywheel 6 poles

VESPA 90 - 125 dal / since 1960

(Sim.086482)

(interasse fori d'attacco / wheelbase hole connection mm. 42,7)



ART. 7083

per volano 6 poli / for flywheel 6 poles

VESPA 125 ('58->'59) - APE 125 ('58->'59)

(Sim.082706)

(interasse fori d'attacco / wheelbase hole connection mm. 42,7)



BOBINE LUCI

LIGHTS COILS



ART. 7053

VESPA 50 - 50 SPECIAL

(Sim.122121)

(interasse fori d'attacco mm.58)
(wheelbase hole connection mm. 58)

ART. 7057

VESPA 50

(Sim.150770-91436-91438)

(interasse fori d'attacco mm.58)
(wheelbase hole connection mm. 58)



ART. 7050-A

VESPA 90 - 125 - 150 ('60->62)
VESPA RALLY 180

(Sim.160844)

AVVOLGIMENTO SEMPLICE
(CAVO FINE)
SIMPLE WINDING (FINE CABLE)

(interasse fori d'attacco mm.43)
(wheelbase hole connection mm. 43)

ART. 7050-B

VESPA 90 - 125 - 150 ('60->62)
VESPA RALLY 180

(Sim.160845)

DOPPIO AVVOLGIMENTO
(CAVO GROSSO)
DOUBLE WINDING (BIG CABLE)

(interasse fori d'attacco mm.43)
(wheelbase hole connection mm. 43)



ART. 7052-A

VESPA 90 - 90 SPECIAL
VESPA 125 PRIMAVERA

(Sim.1568754)

(interasse fori d'attacco mm.43)
(wheelbase hole connection mm. 43)

ART. 7052-B

VESPA 90 - 90 SS
VESPA 125 PRIMAVERA

(Sim.156876)

(interasse fori d'attacco mm.43)
(wheelbase hole connection mm. 43)



ART. 7055

VESPA ('51->'52) - 2ª SERIE ('53->'57)
VESPA 150E - GL 150 - SS
RALLY 180 - GS (senza spinterogeno)
APE 150 ('60)
(Sim.93331)

(interasse fori d'attacco mm.43)
(wheelbase hole connection mm. 43)



ART. 7056-A

VESPA 125 ('58->'59)
VESPA 98 - 125 4ª SERIE
APE 150 ('56->'57)

(Sim.20842-82151)

(interasse fori d'attacco mm.43)
(wheelbase hole connection mm. 43)



ART. 7056-B

VESPA 125 ('58->'59)
VESPA 98 - 125 4ª SERIE
APE 150 ('56->'57)

(Sim.93309-91493)

(interasse fori d'attacco mm.43)
(wheelbase hole connection mm. 43)



ART. 7058-A

VESPA 125
(V1T dal/since n. 18451)
(V11->V15 - V30->33) ('48->'52)

(Sim.12549)

(interasse fori d'attacco mm.43)
(wheelbase hole connection mm. 43)

ART. 7058-B

VESPA 125
(V1T dal/since n. 18451)
(V11->V15 - V30->33) ('48->'52)

(Sim.12553)

(interasse fori d'attacco mm.43)
(wheelbase hole connection mm. 43)



BOBINE LUCI

LIGHTS COILS



ART. 7054-A

VESPA GS 150 (VS 3/4/5 '57->'61)
VESPA GS 160

(interasse fori d'attacco mm.43)
(filo rame mm. 0,95)
(wheelbase hole connection mm. 43)
(copper wire mm. 0,95)

ART. 7054-B

VESPA GS 150 (VS 3/4/5 '57->'61)
VESPA GS 160

(interasse fori d'attacco mm.43)
(filo rame mm. 0,90)
(wheelbase hole connection mm. 43)
(copper wire mm. 0,90)



BOBINE ALIMENTAZIONE

OUTER H.T.

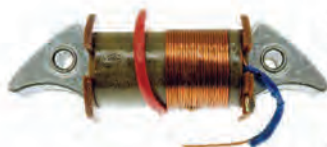

ART. 7060

VESPA 50 - 50 SPECIAL

(Sim.156390)
(interasse fori d'attacco mm.58)
(wheelbase hole connection mm. 58)

ART. 7061

VESPA 50 - APE 50
CON BOBINA AT ESTERNA
WITH EXTERNAL COIL

(Sim.150769)
(interasse fori d'attacco mm.58)
(wheelbase hole connection mm. 58)

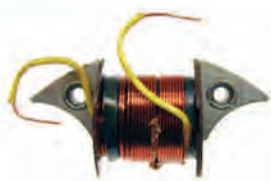

ART. 7062

per volano 6 poli
for flywheel 6 poles

VESPA 125 ('65) - GTR 125
VESPA SUPER 125-150 ('63)
VESPA SPRINT 150

(Sim.91429)
(interasse fori d'attacco mm.43)
(wheelbase hole connection mm. 43)

ART. 7063

per volano 6 poli
for flywheel 6 poles

VESPA 150 ('55->'62)
GL 150 - 180 SS
APE C3 - C4 ('61) - APE C150

(Sim.23361)
(interasse fori d'attacco mm.43)
(wheelbase hole connection mm. 43)

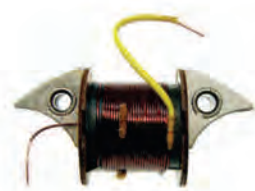

ART. 7065

VESPA 125 PRIMAVERA
RALLY 180

(Sim.91491-93308-90442)
(interasse fori d'attacco mm.43)
(wheelbase hole connection mm. 43)

ART. 7064

per volano 6 poli
for flywheel 6 poles

VESPA GS 150 con spinterogeno
APE 150 ('60)

(Sim.027233)
(interasse fori d'attacco mm.43)
(wheelbase hole connection mm. 43)

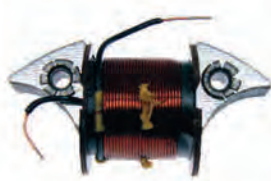
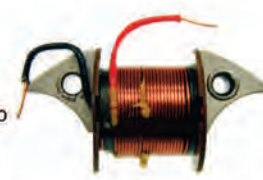

ART. 7066

VESPA GS 150 (VS 3/4/5 '57->'61)
VESPA GS 160

(interasse fori d'attacco mm.43)
(wheelbase hole connection mm. 43)

ART. 7069

BOBINA CARICA CONDENSATORE
IMPIANTO ELETTRONICO
COIL CHARGE CONDENSER,
ELECTRONIC SYSTEM

VESPA RALLY 200

(interasse fori d'attacco mm.43)
(wheelbase hole connection mm. 43)





COMMUTATORI SWITCHES



ART. **9121-E**

COMMUTATORE
SWITCH

VESPA PX PE - PX PE ARCOBALENO

(Sim.160743)



ART. **9137**

COMMUTATORE COMPLETO A 5 POSIZIONI
COMPLETE SWITCH, 5 POSITIONS

VESPA GS 160 VSB1 ('63-'64)

(Sim. 70113)



ART. **9138**

COMMUTATORE COMPLETO A 5 POSIZIONI - 8 POLI
SWITCH COMPLETE, 5 POSITIONS - 8 POLES

VESPA GS 150 VS5 ('59-'61)

VESPA GS 160 VSB1 ('62-'64)

(Sim. 92962)



ART. **9139**

COMMUTATORE COMPLETO A 5 POSIZIONI
SWITCH COMPLETE POSITIONS

VESPA 180 SS

(Sim. 071676)



ART. **9136**

CHIAVE SIEM
KEY

VESPA GS

(Sim. 056940)



ART. **9122**

PULSANTE SPEGNI MOTORE
STOP ENGINE BUTTON

VESPA RALLY 200

(Sim. 73185)

INTERRUTTORI STOP

STOP SWITCHES

ART. 9130

INTERRUTTORE STOP
STOP SWITCH

VESPA 125-150
VESPA SUPER
VESPA SPRINT
VESPA RALLY
VESPA GTR

(Sim. 55316)



ART. 9133

INTERRUTTORE STOP
STOP SWITCH

VESPA 125 (VNB1T '60)
VESPA 150 (VBA1T '59-'60 / VBB1T '61-'62)
VESPA GL 150 (VLA1T '63-'64)
VESPA GS 150 (VS4T '58 / - VS5T '59-'61)
VESPA GS 160 (VSB1T '62-'64)
VESPA 180 SS (VSC1T '65-'68)

(Sim.181637 ex 093722)



ART. 9131

INTERRUTTORE STOP
STOP SWITCH

PER **VESPA CON LAMPEGGIATORI**
FOR **VESPA WITH INDICATORS LIGHT**

VESPA FL 50 ('90) - FL 125 ('89-'90) - FL2 HP 50 ('91-'97)
VESPA N 50 ('89-'90) - PK 50 ('82-'84) - PK XL 50 ('85-'88)
VESPA PK XL 125 ('86-'89) - RUSH 50 ('88-'89)
VESPA PX 125 ('98-'01) - PX 125/150 ('11-'12)
VESPA PX 30 ANNI 125 ('07-'08) - PX EU2 125 ('01-'07)
VESPA T5 125 ('85-'89)-PXE ARCOBALENO 125 ('81-'97)

(Sim.181881)

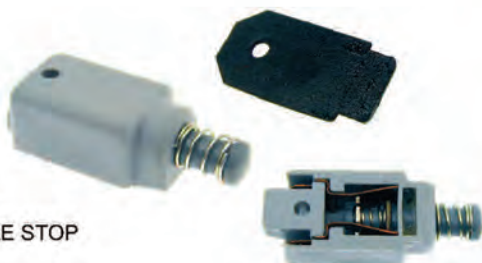

ART. 9132

INTERRUTTORE STOP
STOP SWITCH

PER **VESPA SENZA LAMPEGGIATORI**
FOR **VESPA WITHOUT INDICATORS LIGHT**

VESPA 50 ('67-'82)
VESPA 125 PRIMAVERA
VESPA ET3
VESPA PX PE

(Sim.181878)

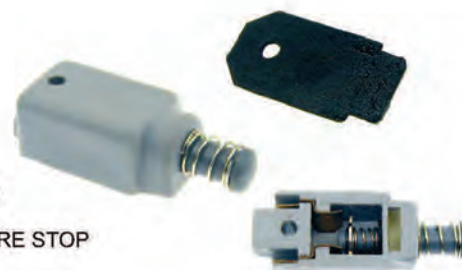

ART. 9143

COMMUTATORE STOP (A LASCIARE)
STOP SWITCH (TO LEAVE)



ART. 9144

COMMUTATORE STOP (A TIRARE)
STOP SWITCH (TO POOL)





PRESE BASSA TENSIONE

L.T. SOCKETS ASSY



ART. **7244**

PRESA BASSA TENSIONE

L.T. SOCKET ASSY

VESPA 50 - 50L - 50R - 50S

VESPA 90 - 90S

VESPA 125 PRIMAVERA ('67->)

VESPA 125 E13

APE 50 TL1 - TL2

(Sim. 70744)



ART. **7245**

PRESA BASSA TENSIONE

L.T. SOCKET ASSY

VESPA 125

VESPA SUPER 125-150

VESPA GTR 125

VESPA GL 150

VESPA SPRINT VELOCE 150

VESPA RALLY

(Sim. 120811)

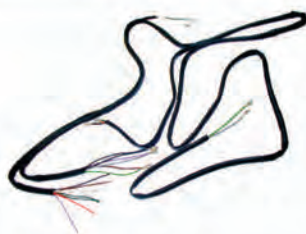

IMPIANTI ELETTRICI

ELECTRICAL EQUIPMENT WIRES

TABELLA RIEPILOGATIVA IMPIANTI ELETTRICI ELECTRICAL EQUIPMENT WIRES LIST

CIF ART.	RIF. ORIG.	APPLICAZIONI / APPLICATIONS
9600	102462	VESPA 50 (V5A1-V5A2) CON BOBINA AT ESTERNA / WITH EXTERNAL H.T. COIL
9600-A	102462	VESPA 50 N - L - R (FINO/TILL TO 1972) CON BOBINA AT INTERNA / WITH INTERNAL H.T.COIL
9601	142965	VESPA 50 SPECIAL
9610	243203	VESPA PK 50-PK 50 S CON FRECCHE/WITH DIRECTION INDICATOR (V5X2T) (impianto completo di connettore / equipment complete with connector)
9602	144505	VESPA 90 - 125 PRIMAVERA (VMA2T)
9603	149247	VESPA 125 PRIMAVERA ET3 (VMB1T)
9608	022681	VESPA 125 (VN1T-2T) (VM1T-2T) ('51-'57) TUTTI MODELLI CON FARO SU PARAFANGO
9617	081021	VESPA 125 (VNA1T - VNA2T)
9622	093489	VESPA 125 (VNB2T - VNB3T - VNB4T - VNB5T) SENZA BATTERIA / WITHOUT BATTERY
9606	091462	VESPA 125 ('65-'66)-150 (VBB2 '63-'66) - SUPER 125-150 VESPA SPRINT 150 ('65-'74 DAL TELAIO 025401)
9612	162064	VESPA PX 1ª SERIE SENZA FRECCHE / WITHOUT DIRECTION INDICATIONS
9604	243566	VESPA PX PE 125-150-200 2ª SERIE CON FRECCHE SENZA AVVIAMENTO ELETTRICO WITH DIRECTION INDICATORS AND WITHOUT ELECTRIC START
9613	217897	VESPA PX PE 125-150-200 ('83->) SENZA AVVIAMENTO ELETTRICO / WITHOUT ELECTRIC START (impianto completo di connettore / (equipment complete with connector)
9614	242182	VESPA PX PE 125-150-200 ARCOBALENO PRODUZIONI ANNI 90 (2ª serie) CON AVVIAMENTO ELETTRICO / WITH ELECTRIC START (impianto completo di connettore / equipment complete with connector)
9618	084354001	VESPA 150 (VBA1T) CON BATTERIA / WITH BATTERY (DAL TELAIO 76050)
9623	081300	VESPA 150 (VL3T) - VESPA 150 (VB1T) CON BATTERIA / WITH BATTERY VESPA GL (VGL1T ESTERO/FOREIGN)
9616	057126	VESPA 150 (VBB1T dal telaio 71001->146000) VESPA GL 150 (VGLA1 ESTERO/FOREIGN)-(VGLB1 ESTERO/FOREIGN)
9609	070651	VESPA GL 150 (VLA1T) - VESPA 150 (VBB1T) CON BATTERIA / WITH BATTERY
9620	093736	VESPA GS 160 (VSB1T) CON BATTERIA / WITH BATTERY (fino al telaio 36000)
9621	070124	VESPA GS 160 (VSB1T) CON BATTERIA / WITH BATTERY (2ª SERIE dal telaio 36001)
9607	114309	VESPA RALLY 180 - SPRINT VELOCE 150 - GTR 125

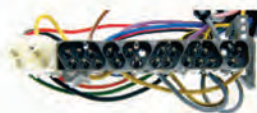



IMPIANTI ELETTRICI ELECTRICAL EQUIPMENT WIRES



ART. **9600**

(Sim.102462)

VESPA 50 (V5A1-V5A2)
CON BOBINA AT ESTERNA / WITH EXTERNAL H.T. COIL

ART. **9600-A**

(Sim.102462)



VESPA 50 N - L - R (FINO A / TILL TO 1972)
CON BOBINA AT INTERNA / WITH INTERNAL H.T.COIL



ART. **9601**

(Sim.142965)

VESPA 50 SPECIAL

ART. **9610**

(Sim.243203)

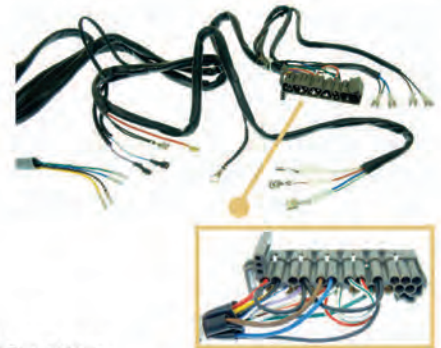

VESPA PK 50-PK 50 S (V5X2T)
CON FRECCHE/WITH DIRECTION INDICATOR
(impianto completo di connettore/equipment complete with connector)



ART. **9602**

(Sim.144505)

VESPA 90 - 125 PRIMAVERA (VMA2T)

ART. **9603**

(Sim.149247)



VESPA 125 PRIMAVERA ET3 (VMB1T)



ART. **9608**

(Sim.022681)

VESPA 125 (VN1T-2T) (VM1T-2T) (51-57)
TUTTI MODELLI CON FARO SU PARAFANGO

ART. **9617**

(Sim.081021)



VESPA 125 (VNA1T - VNA2T)

IMPIANTI ELETTRICI

ELECTRICAL EQUIPMENT WIRES



ART. **9622**

(Sim.093489)

VESPA 125 (VNB2T - VNB3T - VNB4T - VNB5T)
SENZA BATTERIA / WITHOUT BATTERY



ART. **9606**

(Sim.091462)

VESPA 125 ('65-'66) - VESPA 150 (VBB2 '63-'66)
VESPA SUPER 125-150
VESPA SPRINT 150 ('65-'74 DAL TELAIO 025401)



ART. **9612**

(Sim.162064)

VESPA PX 1ª SERIE
SENZA FRECCE / WITHOUT DIRECTION INDICATIONS



ART. **9604**

(Sim.243566)

VESPA PX PE 125-150-200 2ª SERIE
CON FRECCE SENZA AVVIAMENTO ELETTRICO
WITH DIRECTION INDICATORS, WITHOUT ELECTRIC START

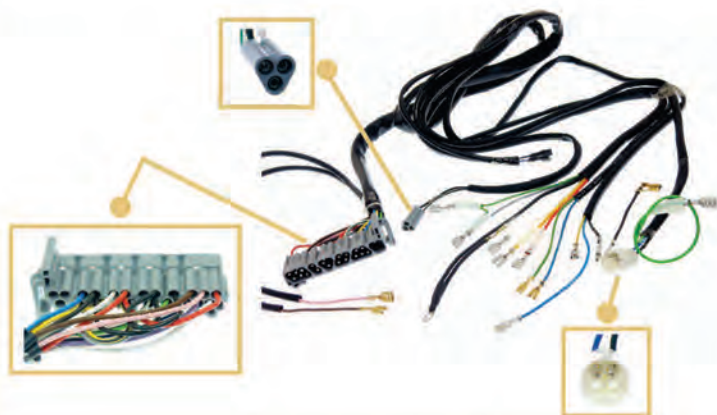

ART. **9613**

(Sim.217897)

VESPA PX PE 125-150-200 ('83->)
SENZA AVVIAMENTO ELETTRICO / WITHOUT ELECTRIC START

(impianto completo di connettore)
(equipment complete with connector)

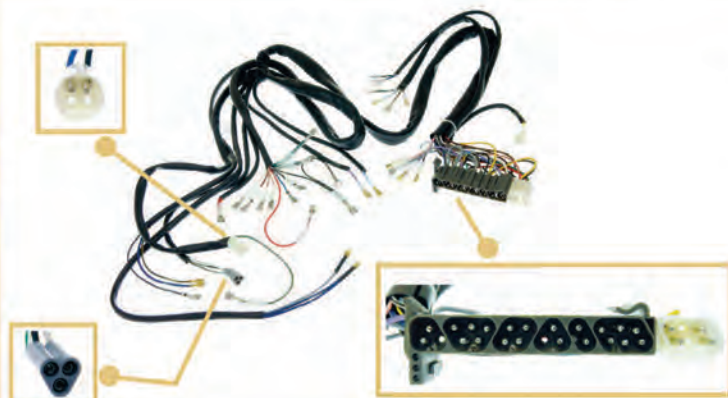

ART. **9614**

(Sim.242182)

VESPA PX PE 125-150-200 ARCOBALENO
PRODUZIONE ANNI 90 (2ª serie)
CON AVVIAMENTO ELETTRICO / WITH ELECTRIC START

(impianto completo di connettore)
(equipment complete with connector)



IMPIANTI ELETTRICI

ELECTRICAL EQUIPMENT WIRES

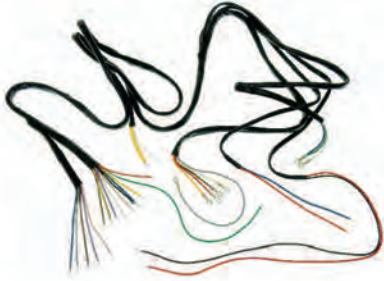

ART. **9618**

(Sim.084354001)

VESPA 150 (VBA1T)
CON BATTERIA / WITH BATTERY (DAL TELAIO 76050)



ART. **9623**

(Sim.081300)

VESPA 150 (VL3T)
VESPA 150 (VB1T) CON BATTERIA / WITH BATTERY
VESPA GL (VGL1T ESTERO/FOREIGN)

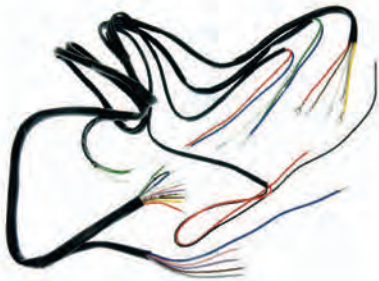

ART. **9616**

(Sim.057126)

VESPA 150 (VBB1T dal telaio 71001->146000)
VESPA GL 150 (VGLA1 ESTERO/FOREIGN)
VESPA GL 150 (VGLB1 ESTERO/FOREIGN)



ART. **9609**

(Sim.070651)

VESPA GL 150 (VLA1T) - VESPA 150 (VBB1T)
CON BATTERIA / WITH BATTERY



ART. **9620**

(Sim.093736)

VESPA GS 160 (VSB1T)
CON BATTERIA / WITH BATTERY (fino al telaio 36000)

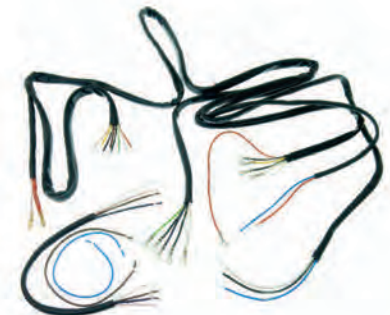

ART. **9621**

(Sim.070124)

VESPA GS 160 (VSB1T)
CON BATTERIA / WITH BATTERY (2ª SERIE dal telaio 36001)

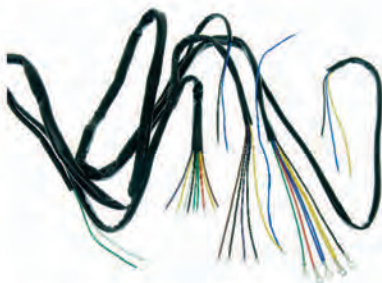

ART. **9607**

(Sim.114309)

VESPA RALLY 180
VESPA SPRINT VELOCE 150
VESPA GTR 125

COMMUTATORI LUCI

LIGHTS SWITCHES

2 POSIZIONI
2 POSITIONS



ART. 9234

COMMUTATORE LUCI
CON PULSANTINO D'ARRESTO / WITH STOP BUTTON

VESPA 50 - 50R - 50L - APE 50

(Sim. 92654)



ART. 9101

COMMUTATORE LUCI

VESPA 150 del 1963 - VESPA SUPER - SPRINT - GL

(Sim. 87558)

3 POSIZIONI
3 POSITIONS



ART. 9102

COMMUTATORE LUCI
CON PULSANTINO D'ARRESTO / WITH STOP BUTTON

VESPA 125 PRIMAVERA - 125 GT - GTR - TS

(Sim. 92041)

3 POSIZIONI
3 POSITIONS



ART. 9103

COMMUTATORE LUCI

VESPA 125 PRIMAVERA ET3 - VESPA RALLY 200

(Sim. 143324)



ART. 9117

COMMUTATORE LUCI (+ 1 CONNESSIONE)
COPERCHIO IN OTTONE CROMATO

CHROME-PLATED BRASS COVER (+1 CONNECTION)

VESPA 150 (VBA1T)

(Sim. 89472)



ART. 9118

COMMUTATORE LUCI
COPERCHIO IN OTTONE CROMATO

CHROME-PLATED BRASS COVER

VESPA 125 (1959)

(Sim. 89471)



COMMUTATORI LUCI LIGHTS SWITCHES



ART. 9104
COMMUTATORE LUCI
VESPA 125 (FINO AL V15T)
(Sim. 015101)



ART. 9107
COMMUTATORE LUCI
VESPA 125 (DAL V30T al V33T)
(Sim. 015100)



ART. 9109
COMMUTATORE LUCI
VESPA 125 (VM1T-VU1T)
(Sim. 020042)



ART. 9110
COMMUTATORE LUCI
VESPA 125 (VM2T-VN1T/2T '54-'57)
VESPA 150 (Fino telaio 51010 '55-'56)
(Sim. 0211102)



ART. 9105
DEVIO LUCI 2 POSIZIONI / 2 POSITIONS
(TIPO SIEM)
VESPA GS
(Sim.026457)

COMMUTATORI SWITCHES



ART. **5142**

COMMUTATORE FRECCHE
DIRECTION INDICATOR SWITCH

VESPA PX PE 125-150-200 1ª SERIE FINO AL / TILL TO 1981

(Sim. 163132)



ART. **5143**

COMMUTATORE LUCI
LIGHTS SWITCH

VESPA P 80-125-150 X - P200E FINO AL/TILL TO 1981
VESPA PX 80-100-125-200E FINO AL/TILL TO 1981
VESPA P150-S DAL/SINCE 1978

PER VEICOLI CON FRECCHE (IMPIANTO 12V)
FOR VEHICLES WITH DIRECTIONS INDICATOR

(Sim. 149185)



ART. **5140**

COMMUTATORE FRECCHE
DIRECTION INDICATOR SWITCH

VESPA PK 50 - PK 50 XL - RUSH - N - PK 125 XL - S
VESPA PX 125-150-200 E ARCOBALENO DAL / SINCE 1983
VESPA 125 T5

(Sim. 580395 - 215968)



ART. **5137**

COMMUTATORE FRECCHE - 8 FILI
DIRECTION INDICATOR SWITCH, 8 WIRES

VESPA PK 50 S

(Sim. 216535)



COMMUTATORI SWITCHES



ART. **5141**

COMMUTATORE LUCI
LIGHTS SWITCH

VESPA PX 125 - 150 - 200E ARCOBALENO DAL/SINCE 1983
(PK 125-S - PX 125E ESTERO/FOREIGN DAL/SINCE 1982)

(Sim. 232240-217898)

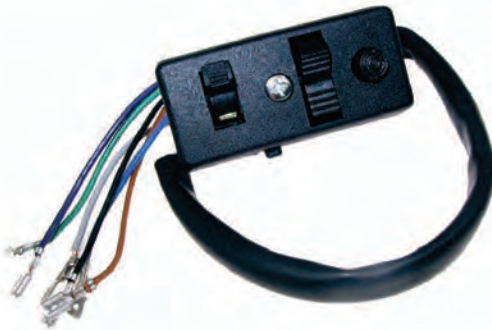

ART. **9106**

COMMUTATORE LUCI
LIGHT SWITCH

VESPA 50 S

(Sim. 123152)



ART. **5139**

COMMUTATORE FRECCE
DIRECTION INDICATOR SWITCH

VESPA PX 125

(Sim.215669)



ART. **5138**

COMMUTATORE LUCI
LIGHT SWITCH

VESPA PX 125

(Sim.215668)



LAMPADINE OMOLOGATE **6V**

APPROVED LIGHT BULBS

LAMPADINE PER FANALE ANTERIORE

ART. **1400** **BA 20d (6V 25/25W)** BILUCE PER FANALE **ANTERIORE** / FRONT LAMP

VESPA DAL 1946 AL 1977

VESPA FARO BASSO ('48->'51) - 90SS - 125 ('62-'66) - 125 SUPER - PRIMAVERA - ET3 - 150 SUPER ('66->)
 VESPA 150 ('69-'75) - GS ('59-'64) - GL ('59-'62) - GT 125 - SPRINT 150 - GTR 125 - TS
 VESPA 150 SPRINT VELOCE - 180SS - RALLY 180-200



ART. **1401** **BA 20d (6V 15/15W)** BILUCE PER FANALE **ANTERIORE** / FRONT LAMP

VESPA DAL 1946 AL 1977

APPLICATIVI UGUALI A / THE SAME APPLICATION OF CIF ART. 1400

MODIFICA PER OTTENERE PIU' LUMINOSITA' / TO HAVE MORE BRIGHTNESS

ART. **1403** **BA 20d (6V 35/35W)** BILUCE PER FANALE **ANTERIORE** / FRONT LAMP

VESPA - GENERICA



ART. **1432** **P26s (6V 15W)** LUCE ANABBAGLIANTE / BEAM LIGHT

VESPA 50 TUTTI MODELLI

VESPA 50 - SPECIAL 50 - L - R - PK 50 - 50S ('82-'84) - CICLOMOTORI CIAO-SI'-GARELLI

HALOGEN



ART. **1442-H** **P26s (6V 15W) HALOGEN** LUCE ANABBAGLIANTE / BEAM LIGHT

VESPA 50 TUTTI MODELLI

VESPA 50 - SPECIAL 50 - L - R - PK 50 - 50S ('82-'84) - CICLOMOTORI CIAO-SI'-GARELLI

LAMPADINE LUCE DI POSIZIONE

ART. **1411** **BAY 15d (6V 15/3W) DOPPIO FILAMENTO**

LUCE POSIZIONE E STOP FANALE **POSTERIORE**
 POSITION & STOP LIGHT FOR REAR LAMP

MOTOVEICOLI ANNI '60 - LAMBRETTA LI 3ª SERIE



ART. **1414** **BA 15s (6V 5W)** **VESPA 125-150 (ANNI 60)**

LUCE POSIZIONE FANALE **ANTERIORE**
 POSITION LIGHT FOR FRONT LAMP

90SS - PRIMAVERA - ET3 - 125-150 SUPER ('66->)
 125 ('62-'65) - 150 ('59-'65) - GS ('61-'64) - GL ('59-'62)
 GT 125 - GL 150 - SPRINT 150 - SPRINT VELOCE 150
 GTR 125 - 180SS RALLY 180-200

LUCE POSIZIONE FANALE **POSTERIORE**
 POSITION LIGHT FOR REAR LAMP

GTR 125 ('70) - SPRINT VELOCE 150
 RALLY 180 ('68)

FANALI NON SIEM - NOT FOR SIEM LAMP



ART. **1409** **BA 9s (6V 5W)**

VESPA

ART. **1409-A** **BA 9s (6V 3W)**

LUCE POSIZIONE FANALE **ANTERIORE**
 POSITION LIGHT FOR FRONT LAMP

VESPA 125 (VNA - VNB1) - GS (VS5T)

LUCE POSIZIONE FANALE **POSTERIORE**
 POSITION LIGHT FOR REAR LAMP

PK 50 ('82-'84)(V5X1) - PK 50S ('84-'89)(V5X2)



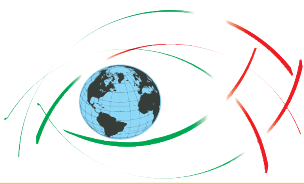

6V

LAMPADINE OMOLOGATE

APPROVED LIGHT BULBS



LAMPADINE LUCE DI POSIZIONE

ART. **1428** (\varnothing lampada 15x43) **(6V 15W)** LUCE POSIZIONE FANALE **ANTERIORE**
POSITION LIGHT FOR FRONT LAMP

VESPA 50

VESPA 50 - 50 SPECIAL - L - N - R - PK 50 - PK 50S ('82-'84) - CIAO - SI' - GARELLI

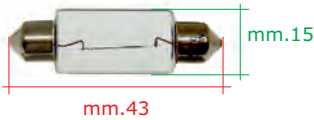

ART. **1428-A** (\varnothing lampada 15x43) **(6V 18W)** LUCE POSIZIONE FANALE **ANTERIORE**
POSITION LIGHT FOR FRONT LAMP

VESPA 50

VESPA 50 - 50 SPECIAL - L - N - R - PK 50 - PK 50S ('82-'84) - CIAO - SI' - GARELLI

ART. **1426** (\varnothing lampada 10,5x38) **(6V 5W)** LUCE POSIZIONE FANALE **POSTERIORE**
POSITION LIGHT FOR REAR LAMP

VESPA FINO AL 1977

VESPA 50 - 50 SPECIAL - L - R - 125 PRIMAVERA - ET3 - 125 ('60-'66) - 150 ('59-'65) - GS 150 ('55-'64)
GL 150 ('59-'64) - 125 ('65) - SUPER 125-150 ('66->) - SPRINT 125 - SPRINT 150 ('64-'66) - 180SS ('65-'68)

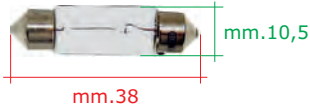

ART. **1427-A** (\varnothing lampada 8x38) **(6V 3W)** LUCE POSIZIONE FANALE **POSTERIORE**
POSITION LIGHT FOR REAR LAMP

VESPA

VESPA 50-50 SPECIAL -L-R- 125 PRIMAVERA-ET3 - 125 (60-66)-150 (59-65)-GS 150 (55-64)-GL 150 (59-64)
125 (65)-SUPER 125-150 (66->)-SPRINT 125- SPRINT 150 (64-66)-180SS (65-68)



LAMPADINE STOP

ART. **1416** **BA15s** **(6V 10W)** LUCE STOP / STOP LIGHT

VESPA 125 - 150 (1960-1977)

VESPA 125 PRIMAVERA - ET3 - 125 ('60-'65) - 150 ('59-'65) - GS 150 ('59-'64) - GL 150 ('59-'66)-SUPER 125-150 ('66->)
SPRINT 150 ('64-'74) - SPRINT VELOCE 150 - 180SS ('64-'68) - GTR 125 ('70->) - RALLY 180 ('68)



ART. **1425** (\varnothing lampada 10,5x38) **(6V 10W)** **PER MODIFICA** LUCE STOP
FOR MODIFIED, STOP LIGHT

VESPA

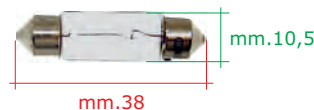

LAMPADINE LUCE SPIA

ART. **1421** (\varnothing lampada 8x31) **(6V 3W)** LUCE SPIA GENERICA
GENERIC WARNING LIGHT

VESPA SPRINT - GT - RALLY 180 - 200



ART. **1436** **BA7s** **(6V 1,2W)** LUCE SPIA SUL COPERCHIO MANUBRIO
WARNING LIGHT ON HANDLEBAR COVER

VESPA PX PE TUTTI MODELLI IMPIANTO 6V





LAMPADINE OMOLOGATE **12V**

APPROVED LIGHT BULBS

LAMPADINE PER FANALE ANTERIORE

ART. **1406** **BA 20D (12V 25/25W)** BILUCE PER FANALE **ANTERIORE** / FRONT LAMP

VESPA PX PE

VESPA PX 125-150 - PE 200 - PX 125-150-200 E - PX 125-150-200 ARCOBALENO-PK 125S ('82-'85)
APE MP - CAR - P2 - P3 - TM P602 - TM P703



mm.20

ART. **1407** **BA 20D (12V 35/35W)** BILUCE PER FANALE **ANTERIORE** / FRONT LAMP

VESPA - SCOOTER

VESPA PK 125 XL (VMX6T) ('86-'89)
SCOOTER 50 VESPA ET4 50 - LIBERTY 50 - ZIP - FLY TUTTI TIPI 2T-4T - SFERA 80

ART. **1408** **BA 20d (12V 45/40W)** BILUCE PER FANALE **ANTERIORE** / FRONT LAMP

MODIFICA PER OTTENERE PIU' LUMINOSITA' / TO HAVE MORE BRIGHTNESS

HALOGEN



mm.20

ART. **1450-H** **BA20d (12V 35/35W)** PER FANALE **ANTERIORE** / FRONT LAMP
HALOGEN

VESPA PX PE
SCOOTER 50 cc. - APE

XENON



mm.20

ART. **1440** **BA20d (12V 35/35W)** PER FANALE **ANTERIORE** / FRONT LAMP
XENON
LUCE BIANCA / WHITE LIGHT

VESPA PX PE
SCOOTER 50 cc. - APE



ART. **1434** **P26s (12V 15W)** LUCE ANABBAGLIANTE / BEAM LIGHT

VESPA PK 50 XL - VESPA 50 FL - FL2 - HP - N - RUSH
APE 50 - FL - FL2 - FL3 - APE 50 EURO2 - RST MIX - TM P50
SCOOTER 50 cc. FREE - NRG - ZIP - SFERA

HALOGEN



ART. **1444-H** **P26s (12V 15W)** LUCE ANABBAGLIANTE / BEAM LIGHT
HALOGEN

VESPA PK 50 XL - VESPA 50 FL - FL2 - HP - N - RUSH
APE 50 - FL - FL2 - FL3 - APE 50 EURO2 - RST MIX - TM P50
SCOOTER 50 cc. FREE - NRG - ZIP - SFERA



12V

LAMPADINE OMOLOGATE
APPROVED LIGHT BULBS



LAMPADINE LUCE DI POSIZIONE



ART. **1412** **BAY 15d (12V 21/5W) DOPPIO FILAMENTO** (Sim. 129953)

LUCE DI POSIZIONE E STOP
FANALE **POSTERIORE**
POSITION / STOP LIGHT FOR REAR LAMP

PIAGGIO VESPA ET2 - ET4 - VESPA LX - LXV
NUOVA VESPA S - VESPA COSA 2 LIBERTY - FREE - FLY - HEXAGON - MP3 - X7 - ZIP
APE CAR - POKER - TM - PORTER - QUARGO
GILERA RUNNER - STALKER - TYPHOON
APRILIA : SCARABEO - SR - LEONARDO - ATLANTIC
MOTOCICLI IN GENERE



ART. **1410** **BA 9s (12V 4W)**

LUCE DI POSIZIONE
ANTERIORE - POSTERIORE
POSITION LIGHT FOR FRONT AND REAR LAMP

VESPA 50 FL ('90) - VESPA 125 T5
APE FL 50 - CAR - TM POKER - SCOOTER NRG - SFERA - ZIP



ART. **1418** **BA15s (12V 5W)**

VESPA PX PE

LUCE POSIZIONE FANALE **ANTERIORE**
POSITION LIGHT FOR FRONT LAMP

LUCE POSIZIONE FANALE **POSTERIORE**
POSITION LIGHT FOR REAR LAMP

VESPA PX 125 - 150 - PE 200 - PX 125-150-200 E
VESPA PX 125-150-200 ARCOBALENO

VESPA PK 50-125 XL -N 50 ('89-'90)-RUSH ('88-'89)
VESPA PX 125-150 - PE 200- PX 125-150-200E



ART. **1418-RED** **BA15 s (12V 5W)**

COLORE ROSSO / RED COLOUR

LUCE DI POSIZIONE **POSTERIORE**
POSITION LIGHT FOR REAR LAMP

SI UTILIZZA SU FANALE POSTERIORE CON GEMMA BIANCA

VESPA PX PE - PX PE ARCOBALENO

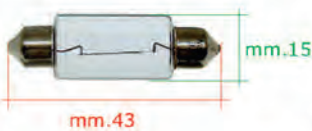

ART. **1429** **(Ø lampada 15x43) (12V 15W)**

LUCE DI POSIZIONE FANALE **ANTERIORE**
POSITION LIGHT FOR FRONT LAMP

VESPA PK 50 XL ('85-'88) - RUSH 50 ('88-'89) - 50 N ('89-'90) - FL 50 ('90)

GENERICA



ART. **1422** **(Ø lampada 10,5x38) (12V 10W)**

LUCE DI POSIZIONE O STOP
POSITION OR STOP LIGHT



ART. **1423** **(Ø lampada 10,5x38) (12V 5W)**

LUCE DI POSIZIONE O STOP
POSITION OR STOP LIGHT



LAMPADINE OMOLOGATE **12V**

APPROVED LIGHT BULBS

LAMPADINE LUCE DI POSIZIONE



mm.9,5

ART. **1466** **W2,1x9.5d W5WT10 (12V 5W) TUTTO VETRO/ALL GLASS**

LUCE POSIZIONE **ANTERIORE-POSTERIORE**
FRONT & REAR POSITION LIGHT

VESPA PX DAL 2006 - ET2-ET4 - GRANTURISMO - GTS - GTV
VESPA LX - NUOVA PRIMAVERA - NUOVA SPRINT - VESPA 946
X7 - X8 - X9 - ZIP DAL 2000 - LIBERTY - FREE - FLY- HEXAGON
BEVERLY - CARNABY - MP3 TYPHOON - RUNNER - NEXUS
APE TM PORTER
APRILIA SCARABEO



mm.9,5

ART. **1465** **W2,1x9.5d W16WT15 (12V 16W) TUTTO VETRO/ALL GLASS** (Sim. 638536)

LUCE **STOP** / STOP LIGHT

VESPA GTS DAL 2005 125-250-300
VESPA GTV DAL 2006 125-250-300
APRILIA ATLANTIC 125-300 (2010) - SPORT CITY 50-125

LAMPADINE FRECCHE VESPA PX PE



mm.15



ART. **1420-FR** **BA 15s (12V 21W)**

LUCE FRECCHE **ANTERIORE - POSTERIORE**
FRONT/REAR INDICATOR DIRECTION LIGHT

VESPA PX 125-150 - PX 125-150-200E
VESPA PX 125-150-200 ARCOBALENO
VESPA 125 T5



mm.15



ART. **1413-FRA** **BA 15s (12V 21W)**

COLORE AMBRA/AMBER COLOUR

LUCE FRECCHE **ANTERIORE - POSTERIORE**
FRONT/REAR INDICATOR DIRECTION LIGHT

**SI UTILIZZA SU CORPI FRECCHE VECCHIE GENERAZIONE
PER SOSTITUZIONE GEMME DA ARANCONI A BIANCHE**

VESPA PX 125-150 - PX 125-150-200E
VESPA PX 125-150-200 ARCOBALENO
VESPA 125 T5



mm.15



ART. **1417-FRA** **BAU15s (12V 21W)**

COLORE AMBRA/AMBER COLOUR (Sim. 584004)

LUCE FRECCHE **ANTERIORE - POSTERIORE**
FRONT/REAR INDICATOR DIRECTION LIGHT

SI UTILIZZA SU CORPI FRECCHE NUOVE GENERAZIONE CON GEMME BIANCHE

VESPA PX 125-150 DAL 2006
APE CALESSINO 200 cc. 2013 - APE CLASSIC 400 2014 - PORTER



12V

LAMPADINE OMOLOGATE

APPROVED LIGHT BULBS



LAMPADINE STOP VESPA PX PE - FRECCE PK



mm.15

ART. **1419**

BA15s (12V 10W)

LUCE **STOP**
STOP LIGHT

VESPA N 50 ('89-'90) - FL 50 ('90)-FL2 - HP 50 ('91-'97)
F12 AUTOMATICA 50 ('90-'91) - PK XL 50-125 ('85-'88)
VESPA PX 125-150-200 ARCOBALENO

LUCE **FRECCE ANTERIORI-POSTERIORI**
REAR-FRONT INDICATORS DIRECTION LIGHT

VESPA PK 50-125 - PK 50-125 XL
RUSH - N - FL2



mm.15

ART. **1419-RED** **BA15s (12V 10W) COLORE ROSSO/RED COLOUR**

LUCE **STOP** / STOP LIGHT

SI UTILIZZA SU FANALE POSTERIORE CON GEMMA BIANCA

VESPA PX PE - PX PE ARCOBALENO

LAMPADINE FRECCE



mm.15

ART. **1415-FRA** **BAU15s (12V 10W) COLORE AMBRA/AMBER COLOUR** (Sim.584332)

LUCE FRECCE **ANTERIORI - POSTERIORI**
FRONT/REAR INDICATORS DIRECTION LIGHT

SI UTILIZZA SU CORPI FRECCE NUOVE GENERAZIONE CON GEMME BIANCHE

SCOOTER - VESPA DAL 2002

VESPA LX - GRANTURISMO - NUOVA VESPA S - LIBERTY - FLY - BEVERLY - CARNABY - MP3 - NRG - X7
X9 - X10 - GILERA TYPHOON - NEXUS - STALKER - APRILIA SCARABEO - ATLANTIC - SR



mm.9,5

ART. **1466-FRA** **W2,1x9,5d WY5W T10 (12V 5W) COLORE AMBRA/AMBER COLOUR**
TUTTO VETRO/ALL GLASS (Sim.581904)

LUCE FRECCE **ANTERIORI**
FRONT INDICATORS DIRECTION LIGHT

SI UTILIZZA SU CORPI FRECCE NUOVE GENERAZIONE CON GEMME BIANCHE

SCOOTER - VESPA DAL 2002

VESPA GRANTURISMO - GTS - GTV - ZIP - X8 - MP3 - GILERA NEXUS 125-250-300-500
APRILIA SR MAX 125-300

LAMPADINE LUCI CRUSCOTTI



mm.4,6

ART. **1438** **W2x4,6d - T5 MINI WEDGE (12V 1,2W)**
TUTTO VETRO/ALL GLASS (Sim.164634)

SPIA LUCI E FRECCE
INDICATORS & WARNING LIGHTS

VESPA - SCOOTER - APE

VESPA PK - FL2 - FL2 AUTOMATICA - HP - PX (DAL 1981 AL 1984) - VESPA LX - GTV SFERA - ZIP
FREE - LIBERTY - BEVERLY - CARNABY - NRG - X7 - APE CAR - POKER - TM - APE 50 FL-FL2-FL3
GILERA TYPHOON - STALKER - NEXUS - RUNNER - VESPA LML STAR 125/150



mm.7

ART. **1437** **BA 7s (12V 2W)**

SPIA LUCI E FRECCE
INDICATORS & WARNING LIGHTS

VESPA PX PE FINO AL / TILL TO 1981



LAMPADINE OMOLOGATE **12V**

APPROVED LIGHT BULBS

XENON



ART. **1440** LAMPADINA XENON **BA 20D (12V 35/35W)**

LUCE BIANCA PER FANALE **ANTERIORE**
BULB, WHITE LIGHT FOR FRONT LAMP

VESPA PX PE
PIAGGIO SCOOTER 50 cc - APE

HALOGEN



ART. **1450-H** LAMPADINA HALOGEN **BA 20D (12V 35/35W)**

PER FANALE **ANTERIORE** / FRONT LAMP

VESPA PX PE
PIAGGIO SCOOTER 50 cc. - APE

HALOGEN



ART. **1444-H** LAMPADINA HALOGEN **P26s (12V 15W)**

LUCE ANABBAGLIANTE / BEAM LIGHT

VESPA PK 50 XL - VESPA 50 FL - FL2 - HP - N - RUSH
PIAGGIO SCOOTER 50 cc. FREE - NRG - SFERA - ZIP
PIAGGIO APE 50 - FL - FL2 - FL3 - APE 50 EURO2 - RST MIX - TM P50

HALOGEN



ART. **1453-H** LAMPADINA HALOGEN **P14,5s H1 (12V 55W)**

(Sim. 580141)

LUCE ANABBAGLIANTE / BEAM LIGHT

PIAGGIO HEXAGON GT-GTX - LX - LXT - LX4 - MP3 - SKIPPER - X10
PIAGGIO PORTER 1200-1300
GILERA RUNNER FX - FXR - VX - VXR - GP 800 cc.

HALOGEN



ART. **1456-H** LAMPADINA HALOGEN **HS1 (12V 35/35W)**

(Sim. 231215)

PER FANALE **ANTERIORE** / FRONT LAMP

VESPA PX 125-150 ('11)
VESPA PX 30 ANNI 125 ('07-'08)
VESPA S 2T-4T COLLEGE 50 - FLY 4T 50
VESPA COSA CL-CLX - COSA2
GILERA DNA 50 ('00->) - GP 50 - GSM 50 - ICE 50 - STORM EU2 - TYPHOON 50 ('01) - ZULU 50



12V LAMPADINE OMOLOGATE

APPROVED LIGHT BULBS



HALOGEN



ART. **1459-H** LAMPADINA HALOGEN **H4 P43 E13 (12V 60/55W)** 3 ATTACCHI
PER FANALE **ANTERIORE** / FRONT LAMP

PIAGGIO BEVERLY CRUISER 250-500- TOURER EU3 125-250-300-400 - CARNABY
CRUISER 300- FLY 125-150 - LIBERTY 4T EURO3 125-150-200 - RST 125-200
VESPA GT 125-200 - GTS 125-250-300 -LX 125-150 - PORTER

GILERA: DNA 125 - 180 - NEXUS EURO3 125-250-300-500
RUNNER FX-FXR 125-180- RUNNER PUREJET 50 - SP 50 - VX-VXR 125-180-200
STALKER 50 - TYPHOON 125 - X-XR 50-125

HALOGEN



ART. **1454-H** LAMPADINA HALOGEN **H7 PX26D E13 (12V 55W)**
PER FANALE **ANTERIORE** / FRONT LAMP

PIAGGIO: BEVERLY 125 - 250 - 350 - 400
BEVERLY EU3 - EU3 MIC - EU3 SPORT - RST
HEXAGON GT - GTX 250 - LX - LXT - LX4 125 - SUPER HEXAGON GTX
LIBERTY 125 - VESPA ET4 125
X EVO 400 - X10 125-350 - X7 125-250-300 - X8 125-250-400 - X9 125-200-500
PORTER

GILERA: NEXUS 125-250-300-500 - RUNNER FX-FXR 125-180 - VX-VXR 125-180-200

HALOGEN



ART. **1455-H** LAMPADINA HALOGEN **H8 PGJ 19-1 (12V 35W)** (Sim.580734)
PER FANALE **ANTERIORE** / FRONT LAMP

PIAGGIO: NRG POWER DD - SR, SPECIALE - POWER PUREJET 50 cc.

GILERA: FUOCO 4T-4V IE - FUOCO EURO 3 500 cc.
RUNNER 4T ST-POGGIALI-PUREJET - SP 50-RUNNER VX-VXR 125/200

APRILIA: SR IE E CARBURATORE 50 ('14)
SR R FACTORY IE E CARBURATORE-50 (2010->)

HALOGEN



ART. **1457-H** LAMPADINA HALOGEN **H11 PGJ 19-2 (12V 55W)** (Sim.640754)
LUCE ANABBAGLIANTE / BEAM LIGHT

PIAGGIO: CARNABY 125-200-250

APRILIA: ATLANTIC 300- CAPONORD 1200 cc.
RS4 / RS4 REPLICA 50/125 cc. - RSV4 1000 cc.
SRV - SRV ABS 850 cc.

BMW
YAMAHA



LAMPADINE OMOLOGATE

APPROVED LIGHT BULBS



ELENCO RIEPILOGATIVO LAMPADINE OMOLOGATE



APPROVED LIGHT BULBS LIST

ART. 1400	LAMPADINA BILUCE	BA 20D	6V	25/25W
ART. 1401	LAMPADINA BILUCE	BA 20D	6V	15/15W
ART. 1403	LAMPADINA BILUCE	BA 20D	6V	35/35W
ART. 1406	LAMPADINA BILUCE	BA 20D	12V	25/25W
ART. 1407	LAMPADINA BILUCE	BA 20D	12V	35/35W
ART. 1408	LAMPADINA BILUCE	BA 20D	12V	45/40W



ART. 1436	LAMPADINA	BA 7s	6V	1,2W
ART. 1437	LAMPADINA	BA 7s	12V	2W



ART. 1409	LAMPADINA	BA 9s	6V	5W
ART. 1409-A	LAMPADINA	BA 9s	6V	3W
ART. 1410	LAMPADINA	BA 9s	12V	4W



ART. 1414	LAMPADINA	BA 15s	6V	5W
ART. 1416	LAMPADINA	BA 15s	6V	10W
ART. 1418	LAMPADINA	BA 15s	12V	5W
ART. 1418-RED	LAMPADINA-ROSSA	BA 15s	12V	5W
ART. 1419	LAMPADINA	BA 15s	12V	10W
ART. 1419-RED	LAMPADINA-ROSSA	BA 15s	12V	10W
ART. 1420-FR	LAMPADINA	BA 15s	12V	21W
* ART. 1413-FRA	LAMPADINA-AMBRA	BA 15s	12V	21W



ART. 1411	LAMPADINA	BAY 15d	6V	15/3W
ART. 1412	LAMPADINA	BAY 15d	12V	21/5W



ART. 1415-FRA	LAMPADINA-AMBRA	BAU 15s	12V	10W
ART. 1417-FRA	LAMPADINA-AMBRA	BAU 15s	12V	21W



ART. 1421	LAMPADINA A SILURO	Ø 8x31	6V	3W
ART. 1427-A	LAMPADINA A SILURO	Ø 8x38	6V	3W
ART. 1425	LAMPADINA A SILURO	Ø 10,5x38	6V	10W
ART. 1426	LAMPADINA A SILURO	Ø 10,5x38	6V	5W
ART. 1422	LAMPADINA A SILURO	Ø 10,5x38	12V	10W
ART. 1423	LAMPADINA A SILURO	Ø 10,5x38	12V	5W
ART. 1428	LAMPADINA A SILURO	Ø 15x43	6V	15W
ART. 1428-A	LAMPADINA A SILURO	Ø 15x43	6V	18W
ART. 1429	LAMPADINA A SILURO	Ø 15x43	12V	15W



ART. 1432	LAMPADINA	P26s	6V	15W
ART. 1434	LAMPADINA	P26s	12V	15W





LAMPADINE OMOLOGATE

E

APPROVED LIGHT BULBS



ELENCO RIEPILOGATIVO LAMPADINE OMOLOGATE

E

APPROVED LIGHT BULBS LIST

ART.1438 LAMPADINA W2x4,6 T5 MINI WEDGE 12V 1,2W



ART.1466 LAMPADINA W2,1x9,5d W5WT10 12V 5W
 *ART.1466-FRA LAMPADINA-AMBRA W2,1x9,5d WY5WT10 12V 5W
 ART.1465 LAMPADINA W2,1x9,5d W16WT15 12V 16W

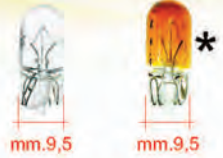

ART. 1440
BA 20d 12V 35/35W
LAMPADINA XENON
(BIANCA / WHITE)



ART. 1450-H
BA 20d 12V 35/35W
LAMPADINA HALOGEN



ART. 1442-H
P26s 6V 15W
LAMPADINA HALOGEN



ART. 1444-H
P26s 12V 15W
LAMPADINA HALOGEN



ART. 1453-H
H1 P14,5s 12V 55W
LAMPADINA HALOGEN
(Sim.580141)



ART. 1456-H
HS1 12V 35/35W
LAMPADINA HALOGEN
(Sim.231215)



ART. 1459-H
H4 P43 E13 12V 60/55W
3 ATTACCHI/CONNECTIONS
LAMPADINA HALOGEN



ART. 1454-H
H7 PX26d E13 12V 55W
LAMPADINA HALOGEN



ART. 1455-H
H8 PGJ 19-1 12V 35W
LAMPADINA HALOGEN
(Sim.580734)



ART. 1457-H
H11 PGJ 19-2 12V 55W
LAMPADINA HALOGEN
(Sim.640754)



GRUPPI OTTICI

HEADLIGHTS



ART. **1700**

GRUPPO OTTICO COMPLETO DI PORTALAMPADA
BULB SOCKET INCLUDED

(Sim.191192)

VESPA 50 SPECIAL



Ø mm.105

ART. **1702**

GRUPPO OTTICO COMPLETO DI PORTALAMPADA
BULB SOCKET INCLUDED

(Sim.101321-70683)

VESPA 50 ('69-'71)
VESPA 50S ('63-'68)
VESPA 50L ('66-'70)
VESPA 50R ('70-'83)



Ø mm.115

ART. **1704**

GRUPPO OTTICO COMPLETO DI PORTALAMPADA
BULB SOCKET INCLUDED

(Sim.091389)

VESPA 50 SS - 90 SS
VESPA 125 ('65-'66)
VESPA 125 PRIMAVERA ET3
VESPA 125 SUPER - 150 SUPER (dal '66)



Ø mm.135

ART. **1712**

GRUPPO OTTICO COMPLETO DI PORTALAMPADA
BULB SOCKET INCLUDED

(Sim.215399)

VESPA PK 50 - 50S
VESPA PK 50 XL
VESPA RUSH - N



GRUPPI OTTICI HEADLIGHTS



Ø mm.115

ART. 1706

GRUPPO OTTICO COMPLETO DI PORTALAMPADA
BULB SOCKET INCLUDED

(Sim.150384)

VESPA 125 ('62-'65) - VESPA 150 ('59-'65)
VESPA GS ('59-'64) - VESPA GL ('59-'62)



ART. 1708

GRUPPO OTTICO COMPLETO DI GHIERA
SENZA PORTALAMPADA

COMPLETE WITH RIM, **WITHOUT** BULB SOCKET

(Sim.151198-70459)

VESPA 125 GT - VESPA 150 GL
VESPA 150 SPRINT - VESPA 180 SS



PORTALAMPADA DI RICAMBIO
BULB SOCKET SPARE

CIF ART. 1893

Ø mm.130



ART. 1710

GRUPPO OTTICO
COMPLETO
DI GHIERA E PORTALAMPADA

COMPLETE WITH RIM AND BULB SOCKET

(Sim.113890)

VESPA 125 GTR - TS
VESPA 150 SPRINT VELOCE
VESPA RALLY 180 - 200

Ø mm.145



ART. 1714

GRUPPO OTTICO
COMPLETO
DI PORTALAMPADA

BULB SOCKET INCLUDED

VESPA P 125-150X - VESPA P200E
VESPA PX 125-150-200E
VESPA PX 125-150-200 ARCOBALENO

CORNICI PER FANALE ANTERIORE

HEADLIGHT RIMS



PER FANALE Ø mm.105

ART. **7340-C**

CORNICE CROMATA
CHROMED RIM

(Sim.151731)

VESPA 50 ('63->'71)
VESPA 50R ('70->'83)
VESPA 50S ('63->'78)
VESPA 50L ('66->'70)

ART. **5286**

PIASTRINA FERMO FANALE
PLATE SEC. HEADLIGHTS

(Sim.138006)

VESPA 50 - 90 - PRIMAVERA - ET3



ART. **7350-C**

CORNICE **INOX ORIG.**

(Sim.124200)

ART. **7350-CARB**

CORNICE
**EFFETTO CARBONIO
LOOK CARBONIO**

VESPA SPECIAL



PER FANALE Ø mm.115

ART. **7341-C**

CORNICE **INOX ORIG.**

(Sim.151742)

ART. **7341-CARB**

CORNICE
**EFFETTO CARBONIO
LOOK CARBONIO**

VESPA 50 - VESPA 90SS ('65->'71) - VESPA 90R ('71->'73)
VESPA 125 ('58->'59) - 125 SUPER ('66->'68) - 150 SUPER ('66->'79)
VESPA 125 PRIMAVERA - 125 PRIMAVERA ET3



PER FANALE Ø mm.130

ART. **7397-C**

CORNICE CROMATA / CHROMED

(Sim. 113891)

VESPA 125 GTR ('69->'78)
VESPA 125 TS ('75->'78)
VESPA 150 SPRINT VELOCE ('69->'79)
VESPA RALLY 180-200 ('68->'79)



CORNICI PER FANALE ANTERIORE

HEADLIGHT RIMS

VESPA PK XL



ART. **7372-C**
CORNICE CROMATA
CHROMED

ART. **7372-N**
CORNICE NERA
BLACK



VESPA PX PE ARCOBALENO



ART. **7396-C**
CORNICE CROMATA
CHROMED



ART. **7396-N**
CORNICE NERA
BLACK



ART. **7396-CARB**
CORNICE
EFFETTO CARBONIO
LOOK CARBONIO

VESPA PX PE



ART. **7394-C**
CORNICE CROMATA
CHROMED



ART. **7394-N**
CORNICE NERA
BLACK



ART. **7394-CARB**
CORNICE
EFFETTO CARBONIO
LOOK CARBONIO



FANALI POSTERIORI

TAILLIGHTS



ART. 1763

FANALE POSTERIORE COMPLETO CON GUARNIZIONE
TAILLIGHT COMPLETE WITH GASKET

(Sim.102459)

VESPA 50L ('66-'70)
VESPA 50 R ('70-'83)



ART. 1765

FANALE POSTERIORE COMPLETO CON GUARNIZIONE
TAILLIGHT COMPLETE WITH GASKET

(Sim.143687)

VESPA 50 SPECIAL



ART. 1767

FANALE POSTERIORE COMPLETO CON GUARNIZIONE
TAILLIGHT COMPLETE WITH GASKET

(Sim. 078641)

VESPA 90- 90 SPRINT - 125
125 PRIMAVERA ('63-'66)



ART. 1769

FANALE POSTERIORE COMPLETO CON GUARNIZIONE
TAILLIGHT COMPLETE WITH GASKET

(Sim. 162986)

VESPA 125 PRIMAVERA - ET3



ART. 1776

FANALE POSTERIORE COMPLETO **SENZA** GUARNIZIONE
TAILLIGHT COMPLETE **WITHOUT** GASKET

(Sim.255946)

VESPA N 50 ('89-'90) - VESPA FL 50 ('90) - VESPA FL2 HP 50 ('91-'97)
VESPA FL2 AUTOMATICA 50 ('90-'91)



FANALI POSTERIORI TAILLIGHTS



ART. 1772

FANALE POSTERIORE COMPLETO CON GUARNIZIONE (Sim. 216444)
TAILLIGHT COMPLETE WITH GASKET

VESPA PK 50 ('82-'94)
VESPA PK S 50 ('84-'89)



ART. 1774

FANALE POSTERIORE COMPLETO CON GUARNIZIONE (Sim. 234225)
TAILLIGHT COMPLETE WITH GASKET

VESPA PK 50 XL
VESPA RUSH



ART. 1775

FANALE POSTERIORE COMPLETO CON GUARNIZIONE (Sim. 2159661)
TAILLIGHT COMPLETE WITH GASKET

VESPA PK 125 - VESPA 125 S - VESPA 125 S AUTOMATICA
VESPA PK 80-100



ART. 1782

FANALE POSTERIORE COMPLETO CON GUARNIZIONE (Sim. 141758)
TAILLIGHT COMPLETE WITH GASKET

VESPA 125 GTR (dal '70)
VESPA TS 125 (VNL3T)
VESPA SPRINT VELOCE 150
VESPA RALLY 180 (dal '68)



FANALI POSTERIORI

TAILLIGHTS



ART. **1778**

FANALE POSTERIORE COMPLETO CON GUARNIZIONE

(Sim.089442)

TAILLIGHT COMPLETE WITH GASKET

VESPA 125 ('60-'64)
VESPA150 ('59-'65)
VESPA GS 150 ('59-'64)
VESPA GL 150 ('59-'64)



ART. **1780**

FANALE POSTERIORE COMPLETO CON GUARNIZIONE

(Sim.91488)

TAILLIGHT COMPLETE WITH GASKET

VESPA 125 (dal '65)
VESPA SUPER 125-150 (dal '66)
VESPA GL e SPRINT 150 ('64-'66)
VESPA180 SS (fino al '65)



ART. **1786**

FANALE POSTERIORE COMPLETO CON GUARNIZIONE

(Sim.162740)

TAILLIGHT COMPLETE WITH GASKET

VESPA P 125-150X
VESPA P200E
VESPA PX 125-150-200E



ART. **1788**

FANALE **TRIOM** POSTERIORE COMPLETO
CON GUARNIZIONE INCLUSE LAMPADINE

(Sim.219091)

*TAILLIGHT COMPLETE WITH GASKET
LIGHT BULBS INCLUDED*

VESPA PX 125-150-200E ARCOBALENO



SOLO PLASTICHE DI RICAMBIO

PLASTICS SPARE ONLY



ART. 1784
CORPO LUMINOSO
PLASTICA ROSSA
PLASTIC BODY
RED COLOUR
(Sim. 150369)

VESPA SUPER 125-150 (dal '66)
VESPA SPRINT 150 ('65-'74) - VESPA 180 SS ('65-'68)

ART. 1793
CORPO LUMINOSO
PLASTICA ROSSA
PLASTIC BODY
RED COLOUR
(Sim. 159431)



VESPA 125 PRIMAVERA - ET3



ART. 1790
CORPO LUMINOSO
PLASTICA ROSSA
PLASTIC BODY
RED COLOUR
(Sim. 162741-183615)

VESPA P 125-150X - PX 125-150-200E - P200E

ART. 1791
CORPO LUMINOSO
PLASTICA ROSSA
PLASTIC BODY
RED COLOUR



VESPA PX 125-150-200E ARCOBALENO



ART. 1790-B
CORPO LUMINOSO
PLASTICA BIANCA
PLASTIC BODY
WHITE COLOUR

VESPA P 125-150X - PX 125-150-200E - P200E

ART. 1791-B
CORPO LUMINOSO
PLASTICA BIANCA
PLASTIC BODY
WHITE COLOUR



VESPA PX 125-150-200E ARCOBALENO



ART. 1418-RED
LAMPADINA LUCE DI **POSIZIONE**
Ba15 s (12V 5W)
POSITION LIGHT BULB
COLORE ROSSO / RED COLOUR



ART. 1419-RED
LAMPADINA LUCE **STOP**
Ba15 s (12V 10 W)
STOP LIGHT BULB
COLORE ROSSO / RED COLOUR



COPPIE FRECCHE

INDICATOR LENSES PAIR

VESPA PX 30 ANNI 125 ('07-'08) - PX 125-150 ('11-'17)

adattabile/suitable: VESPA P125/150X - PX 125-150-200E - PX 125-150-200 ARCOBALENO
VESPA 125 T5 - VESPA LML



ART. 1732

CP. FRECCHE **ANTERIORI**
COMPLETE DI PORTALAMPADA
CORPO CROMATO - GEMME BIANCHE

PAIR OF FRONT INDICATOR LENSES,
BULB SOCKET INCLUDED, CHROME BODY-WHITE PLASTIC

(Sim.638761+638762)



ART. 1733

CP. FRECCHE **POSTERIORI**
COMPLETE DI PORTALAMPADA
CORPO CROMATO - GEMME BIANCHE

PAIR OF REAR INDICATOR LENSES,
BULB SOCKET INCLUDED, CHROME BODY-WHITE PLASTIC

(Sim.638763+638764)



ART. 1726

CP. GEMME
ANTERIORI

COLORE "BIANCO"

PAIR OF FRONT PLASTIC
WHITE COLOUR

ART. 1727

CP. GEMME
POSTERIORI

COLORE "BIANCO"

PAIR OF REAR PLASTIC
WHITE COLOUR



ART. 1724

CP. GEMME
ANTERIORI

COLORE "FUME"

PAIR OF FRONT PLASTIC
"FUME" COLOUR

ART. 1725

CP. GEMME
POSTERIORI

COLORE "FUME"

PAIR OF REAR PLASTIC
"FUME" COLOUR



ART. 1413-FRA

LAMPADINA - BULB Ba15 s (12V 21W)
PER FRECCHE ANTERIORI / POSTERIORI

FOR FRONT/REAR INDICATOR LENSES

COLORE AMBRA / AMBER



COPPIE FRECCHE

INDICATOR LENSES PAIR



VESPA P125 - 150X - PX 125-150-200E - PX 125-150-200 ARCOBALENO
VESPA 125 T5



ART. **1730**

CP. FRECCHE **ANTERIORI**
COMPLETE DI PORTALAMPADA

PAIR OF FRONT INDICATOR LENSES
BULB SOCKET INCLUDED

(Sim.163256+162817)



ART. **1728**

CP. GEMME **ANTERIORI**
COLORE ARANCIO

PAIR OF FRONT PLASTIC - ORANGE COLOUR



ART. **1420-FR**

LAMPADINA Ba15 s (12V 21W)
PER FRECCHE ANTERIORI / POSTERIORI
FRONT/REAR INDICATOR LENSES BULB



ART. **1731**

CP. FRECCHE **POSTERIORI**
COMPLETE DI PORTALAMPADA

PAIR OF REAR INDICATOR LENSES
BULB SOCKET INCLUDED

(Sim.230338+230339)



ART. **1729**

CP. GEMME **POSTERIORI**
COLORE ARANCIO

PAIR OF REAR PLASTIC
ORANGE COLOUR



COPPIE FRECCE
INDICATOR LENSES PAIR

VESPA PK 50/125



ART. **1736**

CP. FRECCE **ANTERIORI TRIOM**
COMPLETE INCLUSO LAMPADINE

PAIR OF FRONT INDICATOR LENSES
LIGHT BULBS INCLUDED

(Sim.218301+218302)



ART. **1738**

CP. GEMME **ANTERIORI**
COLORE ARANCIO

PAIR OF FRONT PLASTIC, ORANGE COLOUR



ART. **1419**

LAMPADINA BA15 s (12V 10W)
PER FRECCE ANTERIORI / POSTERIORI
FOR FRONT/REAR INDICATOR LENSES BULB

mm.15



ART. **1737**

CP. FRECCE **POSTERIORI TRIOM**
COMPLETE INCLUSO LAMPADINE

PAIR OF REAR INDICATOR LENSES
LIGHT BULBS INCLUDED

(Sim.216784+216785)



ART. **1739**

CP. GEMME **POSTERIORI**
COLORE ARANCIO

PAIR OF REAR PLASTIC, ORANGE COLOUR

(Sim.198500+198502)



COPPIE FRECCHE

INDICATOR LENSES PAIR



VESPA PK 50/125 XL - 50 RUSH - VESPA N - FL2 - VESPA HP - V



ART. **1740**

CP. FRECCHE **ANTERIORI** COMPLETE

PAIR OF FRONT INDICATOR LENSES COMPLETE

(Sim.233970+233971)



ART. **1742**

CP. GEMME **ANTERIORI**
COLORE ARANCIO

PAIR OF FRONT PLASTIC, ORANGE COLOUR



ART. **1419**

LAMPADINA BA15 s (12V 10W)
PER FRECCHE ANTERIORI / POSTERIORI
FOR FRONT/REAR INDICATOR LENSES BULB

mm.15

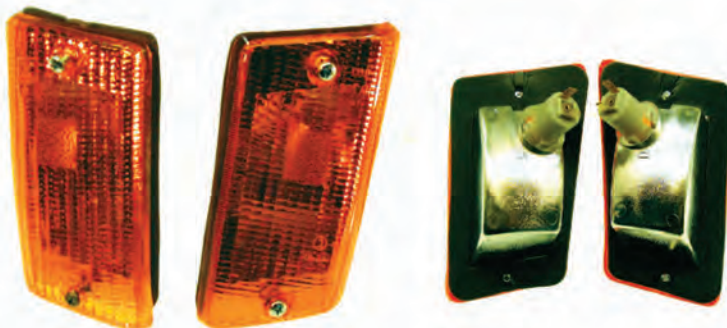

ART. **1741**

CP. FRECCHE **POSTERIORI** COMPLETE

PAIR OF REAR INDICATOR LENSES COMPLETE

(Sim.234061+234065)



ART. **1743**

CP. GEMME **POSTERIORI**
COLORE ARANCIO

PAIR OF REAR PLASTIC, ORANGE COLOUR

GUARNIZIONI FANALI

HEADLIGHTS/TAILLIGHTS GASKETS



ART. 1910
 GUARNIZIONE SOTTOFARO
 ANTERIORE
 FRONT HEADLIGHTS GASKET
 (Sim.014229)

VESPA 125 (DAL V30T AL V33T '51-'52)

ART. 1911
 GUARNIZIONE SOTTOFARO
 ANTERIORE
 FRONT HEADLIGHTS GASKET
 (Sim.018855)



VESPA 125 (VM2T '54) (VN1/2T '58-'59)



ART. 1901
 GUARNIZIONE
 FANALE POSTERIORE
 TAILLIGHTS GASKET
MARCATA SIEM

VESPA 50 PRIMA SERIE DAL 1963
 (RICAMBIO PER / SPARE FOR: CIF ART. 1760)

ART. 1904
 GUARNIZIONE FANALE
 POSTERIORE
 TAILLIGHTS GASKET
MARCATA SIEM



VESPA 50 SS - 90 SS - 125 PRIMAVERA ('63-'66)
 (RICAMBIO PER / SPARE FOR: CIF ART. 1767)



ART. 1900
 GUARNIZIONE
 FANALE POSTERIORE
 TAILLIGHTS GASKET
MARCATA SIEM
 (Sim.089222)

VESPA 125 (VNB1/2/3/4/5 '60-'64) - 150 (VBB1/2T '61-'66)
 VESPA GS 150 (VS5T '59-'61) - GS 160 (VSB1T '62-'64)
 (RICAMBIO PER / SPARE FOR: CIF ART. 1778 / 1778-OR)

ART. 1903
 GUARNIZIONE
 FANALE POSTERIORE
 TAILLIGHTS GASKET
MARCATA SIEM



VESPA 125 (VNA/2T '58>'59) - 150 (VBA1T '59>'60 >110485)
 VESPA GS 150 (VS4T >5T '58>'61 >0087589)



ART. 1905
 GUARNIZIONE
 FANALE POSTERIORE
 TAILLIGHTS GASKET
MARCATA SIEM

VESPA 125 (65>) - SUPER 125-150 (66>) - GL
 VESPA SPRINT 150 ('64>'66) - VESPA 180 SS ('65>'68)
 (RICAMBIO PER / SPARE FOR: CIF ART. 1780 / 1780-OR / 1785-OR)

ART. 1902
 GUARNIZIONE
 FANALE POSTERIORE
 TAILLIGHTS GASKET
MARCATA SIEM
 (Sim. 021085)



VESPA 125 (VM2T '54 - VN1/2T '54>'57 - VNA1/2T '58>'59)
 VESPA 150 (VL1/2/3T '55>'56 - VB1T '57>'58 - VBA1T '59>'60)
 (RICAMBIO PER / SPARE FOR: CIF ART. 1783-OR)



ART. 1930
 GOMMINO BATTUTA COFANO DESTRO / RIGHT HOOD RUBBER STOP (Sim. 018946)
 VESPA 125 (VM1/2T '53>'54 - VN1/2T '54>'57) - VESPA 150 (VL1/2/3T '55>'56 - VB1T '57>'58)



FANALI COMPLETI ORIGINALI SIEM

ORIGINAL SIEM HEADLIGHTS



Vespa 50 Special v5A2 (6V) - 50 Elestart v5A3 (12V)



OMOLOGAZIONE - APPROVAL
DGM7361PCXLA



ART.1700-OR KIT FANALE COMPLETO
(Sim. 123518)

**Fornito con
2 cornici fanale!!**
**Supplied with 2
headlight rim !!**

- ✓ PORTALAMPADA INCLUSO
- ✓ PLASTICA ORIG. MARCATA SIEM
- ✓ CORNICE ORIG. INOX INCLUSA
- ✓ CORNICE SUPPLEMENTARE CROMATA INCLUSA
- ✓ SUPPORTO MONTAGGIO FANALE+MOLLE+VITI

- BULB SOCKET INCLUDED
- PLASTIC SIEM MARKED
- INOX RIM ORIGINAL INCLUDED
- CHROMED RIM INCLUDED
- SUPPORT TO FIX HEADLIGHT + SPRINGS + SCREWS



Vespa 50 ('69-'71) - 50S ('63-'68) - 50L ('66-'70) - 50R ('70-'83)

OMOLOGAZIONE - APPROVAL
DGM3058PCX



Ø mm.105

**ART.1702-OR GRUPPO OTTICO
COMPLETO**
(Sim. 101321-70683)



- ✓ PORTALAMPADA INCLUSO
- ✓ VETRO MARCATO SIEM

- BULB SOCKET INCLUDED
- GLASS SIEM MARKED



FANALI COMPLETI ORIGINALI SIEM

ORIGINAL SIEM HEADLIGHTS



Vespa 50SS - 90 SS - 125 ('65-'66)
125 Super - 150 Super ('66-->) - 125 Primavera - ET3

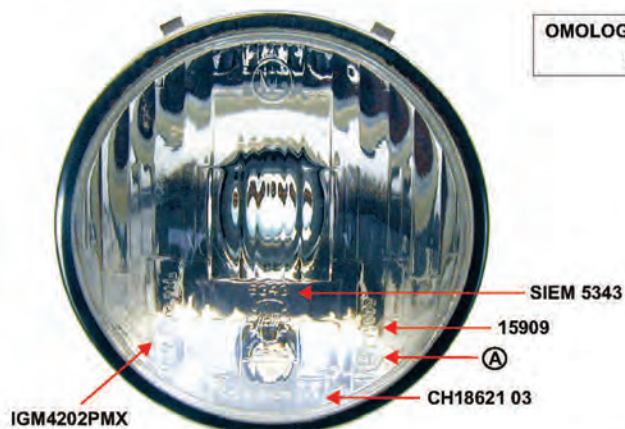

OMOLOGAZIONE - APPROVAL
IGM4202PMX



Ø mm.115

ART.1704-OR GRUPPO OTTICO
COMPLETO
(Sim. 091389)

- ✓ PORTALAMPADA INCLUSO
- ✓ VETRO MARCATO SIEM

BULB SOCKET INCLUDED
GLASS SIEM MARKED



Vespa FL / FL2 50-125 - 50 HP



OMOLOGAZIONE - APPROVAL
DGM36403PC>LA



ART.1711-OR GRUPPO OTTICO
COMPLETO
(Sim. 265940)

- ✓ PORTALAMPADA INCLUSO
- ✓ PORTALAMPADA LUCI POSIZIONE CON
CONNETTORE INCLUSO
- ✓ PLASTICA MARCATO SIEM

BULB SOCKET INCLUDED
POSITION LIGHT BULB SOCKET WITH
CONNECTOR INCLUDED
PLASTIC SIEM MARKED



FANALI COMPLETI ORIGINALI SIEM

ORIGINAL SIEM HEADLIGHTS



Vespa PK 50 - PK 50 XL - PK 50 S - RUSH - 50 N

OMOLOGAZIONE / APPROVAL
DGM 36403PC>LA

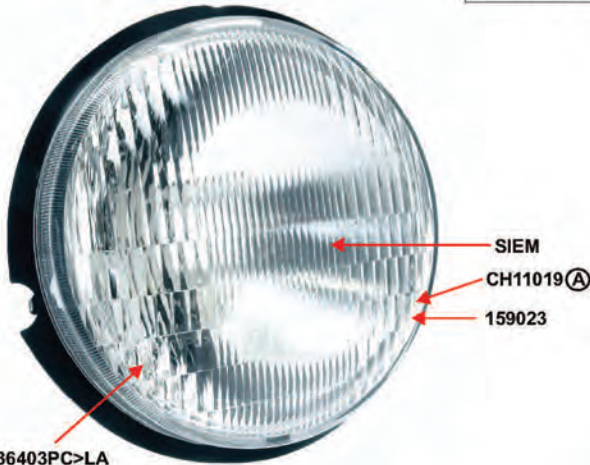

DGM36403PC>LA



Ø mm. 135

SIEM
CH11019 (A)
159023



ART. **1712-OR** GRUPPO OTTICO
COMPLETO
(Sim. 215399)

- ✓ PORTALAMPADA INCLUSO
- ✓ PLASTICA MARCATA SIEM

BULB SOCKET INCLUDED
PLASTIC SIEM MARKED



Vespa PK 80 - 100 - 125 cc.

OMOLOGAZIONE / APPROVAL
DGM 36403PC>LC



Ø mm. 135

CH 11019 (A)
159023



ART. **1713-OR** GRUPPO OTTICO
(Sim. 215967)

- ✓ PLASTICA MARCATA SIEM

PLASTIC SIEM MARKED



FANALI COMPLETI ORIGINALI SIEM
ORIGINAL SIEM HEADLIGHTS



Vespa 125 (dal 1948 al 1951) FANALE SUL PARAFANGO



Ø mm. 95

ART. **1701-OR** FANALE COMPLETO

- ✓ PORTALAMPADA INCLUSO
- ✓ VETRO MARCATO SIEM
- ✓ CORNICE/GHIERA MARCATA SIEM INCLUSA

- BULB SOCKET INCLUDED
- GLASS SIEM MARKED
- RIM SIEM MARKED INCLUDED



Vespa 125 (VM1T 1953) - Vespa 125 (VM2T 1954)

OMOLOGAZIONE - APPROVAL
IGM0444PMX



Ø mm. 105



ART. **1707-OR** FANALE COMPLETO
(Sim.018087)

- ✓ PORTALAMPADA INCLUSO
- ✓ VETRO MARCATO SIEM
- ✓ CORNICE/GHIERA MARCATA SIEM INCLUSA

- BULB SOCKET INCLUDED
- GLASS SIEM MARKED
- RIM SIEM MARKED INCLUDED



FANALI COMPLETI ORIGINALI SIEM
ORIGINAL SIEM HEADLIGHTS



Vespa 125 (VN1T 1955) - Vespa 125 (VN2T 1956)

OMOLOGAZIONE - APPROVAL
IGM0444PMX



Ø mm. 105



ART.1717-OR FANALE COMPLETO
(Sim.026008)

- ✓ PORTALAMPADA INCLUSO
- ✓ VETRO MARCATO SIEM
- ✓ CORNICE/GHIERA MARCATO SIEM INCLUSA

- BULB SOCKET INCLUDED
- GLASS SIEM MARKED
- RIM SIEM MARKED INCLUDED



Vespa 125 (VNA1T '58) (VNA2T '58-'59) (VNB1T '60) (VNB2T '61)

OMOLOGAZIONE - APPROVAL
IGM0444PMX



Ø mm. 105



ART.1705-OR FANALE COMPLETO
(Sim. 087310)

- ✓ PORTALAMPADA INCLUSO
- ✓ VETRO MARCATO SIEM
- ✓ CORNICE/GHIERA MARCATO SIEM INCLUSA

- BULB SOCKET INCLUDED
- GLASS SIEM MARKED
- RIM SIEM MARKED INCLUDED



FANALI COMPLETI ORIGINALI SIEM

ORIGINAL SIEM HEADLIGHTS



Vespa 125 ('62-'65) - Vespa 150 ('59-'65) - GS ('59-'64) - GL ('59-'62)



Ø mm. 115

OMOLOGAZIONE FANALE
HEADLIGHT APPROVAL
IGM0664PX

OMOLOGAZIONE VETRO
GLASS APPROVAL
IGM2177PMX



ART.1706-OR FANALE COMPLETO
(Sim. 92326-150384)

- ✓ PORTALAMPADA INCLUSO
- ✓ VETRO MARCATO SIEM
- ✓ CORNICE/GHIERA MARCATO SIEM INCLUSA

BULB SOCKET INCLUDED
GLASS SIEM MARKED
RIM SIEM MARKED INCLUDED



Vespa GT 125 - GL 150 - SPRINT 150 - Vespa 180 SS



IGM2760PMX

OMOLOGAZIONE - APPROVAL
IGM2760PMX

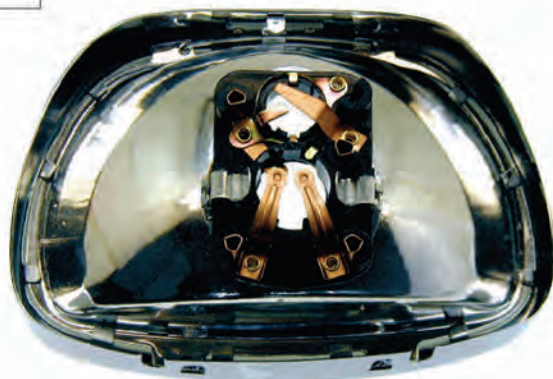

ART.1708-OR FANALE COMPLETO
(Sim. 151198-70459)

- ✓ PORTALAMPADA INCLUSO
- ✓ VETRO MARCATO SIEM
- ✓ CORNICE/GHIERA MARCATO SIEM INCLUSA

BULB SOCKET INCLUDED
GLASS SIEM MARKED
RIM SIEM MARKED INCLUDED



FANALI COMPLETI ORIGINALI SIEM

ORIGINAL SIEM HEADLIGHTS



Vespa GTR - TS 125 - SPRINT VELOCE 150 - RALLY 180-200



Ø mm. 130

OMOLOGAZIONE - APPROVAL
IGM0764PMX



ART.1710-OR FANALE COMPLETO
(Sim. 113890)

- ✓ PORTALAMPADA INCLUSO
- ✓ VETRO MARCATO SIEM
- ✓ CORNICE/GHIERA MARCATATA SIEM INCLUSA

- BULB SOCKET INCLUDED
- GLASS SIEM MARKED
- RIM SIEM MARKED INCLUDED



Vespa 150 (VL1 '55)



Ø mm. 105

OMOLOGAZIONE - APPROVAL
IGM0444PMX



ART.1718-OR FANALE COMPLETO
(Sim. 023447)

- ✓ PORTALAMPADA INCLUSO
- ✓ VETRO MARCATO SIEM
- ✓ CORNICE/GHIERA MARCATATA SIEM INCLUSA

- BULB SOCKET INCLUDED
- GLASS SIEM MARKED
- RIM SIEM MARKED INCLUDED



FANALI COMPLETI ORIGINALI SIEM

ORIGINAL SIEM HEADLIGHTS

Vespa 150 (VL2T '55-'56)



Ø mm. 105

OMOLOGAZIONE - APPROVAL
IGM0444PMX



ART. **1715-OR** FANALE COMPLETO
(Sim. 025483)

- ✓ PORTALAMPADA INCLUSO
- ✓ VETRO MARCATO SIEM
- ✓ CORNICE/GHIERA MARCATA SIEM INCLUSA

BULB SOCKET INCLUDED
GLASS SIEM MARKED
RIM SIEM MARKED INCLUDED



Vespa 150 (VL3T '56)



Ø mm. 105

OMOLOGAZIONE - APPROVAL
IGM0444PMX



ART. **1716-OR** FANALE COMPLETO
(Sim. 025483)

- ✓ PORTALAMPADA INCLUSO
- ✓ VETRO MARCATO SIEM
- ✓ CORNICE/GHIERA MARCATA SIEM INCLUSA
- ✓ PALPEBRA MARCATA SIEM INCLUSA

BULB SOCKET INCLUDED
GLASS SIEM MARKED
RIM SIEM MARKED INCLUSA
CHROMED VISOR INCLUDED SIEM MARKED



FANALI COMPLETI ORIGINALI SIEM
ORIGINAL SIEM HEADLIGHTS



Vespa GS 150 (VS1T '56)

OMOLOGAZIONE - APPROVAL
IGM2177PMX



Ø mm. 115



ART.1719-OR FANALE COMPLETO
(Sim. 025793)

- ✓ PORTALAMPADA INCLUSO
- ✓ VETRO MARCATO SIEM
- ✓ CORNICE/GHIERA MARCATA SIEM INCLUSA

- BULB SOCKET INCLUDED
- GLASS SIEM MARKED
- RIM SIEM MARKED INCLUDED



Vespa 150 (VB1T '57-'58) - GS 150 (VS2-3-4T '56-'58)

OMOLOGAZIONE - APPROVAL
IGM2177PMX



Ø mm. 115



ART.1720-OR FANALE COMPLETO
(Sim. 025793)

- ✓ PORTALAMPADA INCLUSO
- ✓ VETRO MARCATO SIEM
- ✓ CORNICE/GHIERA MARCATA SIEM INCLUSA
- ✓ PALPEBRA MARCATA SIEM INCLUSA

- BULB SOCKET INCLUDED
- GLASS SIEM MARKED
- RIM SIEM MARKED INCLUSA
- CHROMED VISOR INCLUDED SIEM MARKED



FANALI COMPLETI ORIGINALI SIEM

ORIGINAL SIEM HEADLIGHTS



Vespa PX 125 - 150 - 200 ('73-'83)

OMOLOGAZIONE - APPROVAL
DGM32530PMXLA



ART.1714-OR GRUPPO OTTICO
COMPLETO
(Sim. 1R000267)

- PORTALAMPADA INCLUSO
- VETRO MARCATO SIEM

BULB SOCKET INCLUDED
GLASS SIEM MARKED



Vespa PX EU2 125 ('00-'07) - PX 30 ANNI 125 ('07-'08)
Vespa PX 125 ('98-'01) ('11-'17) - VESPA PX 150 ('11-'17)



ART.1723-OR GRUPPO OTTICO
COMPLETO
(Sim. 582946)

- PORTALAMPADA INCLUSO
- VETRO MARCATO SIEM

BULB SOCKET INCLUDED
GLASS SIEM MARKED

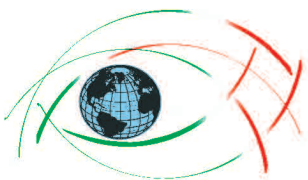

PORTALAMPADA FANALI ANT.

HEADLIGHTS BULB SOCKET



Ø mm. 36

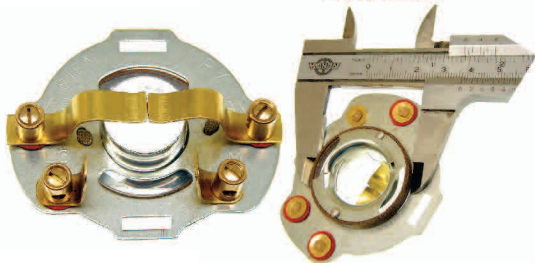

ART. 1890 PORTALAMPADA **SIEM** ADATTABILE A FANALE ANTERIORE

VESPA 125 VM1T ('53) - VM2T ('54)
VESPA 125 VN1T ('55) - VN2T ('56)
VESPA 150 VL1T ('55)
VESPA 150 VL2T ('55-56) - VL3T ('56)
VESPA 150 VB1T ('57-58)
VESPA GS 150 VS1T ('55) - VS2T 2-3-4-T ('56-'58)
(Sim. 25972)

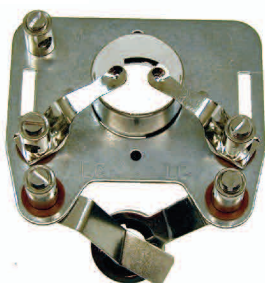

ART. 1892 PORTALAMPADA **SIEM** ADATTABILE A FANALE ANTERIORE

(RICAMBIO PER / SPARE FOR : CIF 1705-OR)
VESPA 125 (VNA1T '58) (VNA2T '58-'59) (VNB1T '60) (VNB2T '61)



ART. 1893 PORTALAMPADA **SIEM** ADATTABILE A FANALE ANTERIORE

(RICAMBIO PER / SPARE FOR : CIF 1708 / 1708-OR)
VESPA GT 125 - GL 150 - SPRINT 150 - 180 SS
(Sim. 97406)

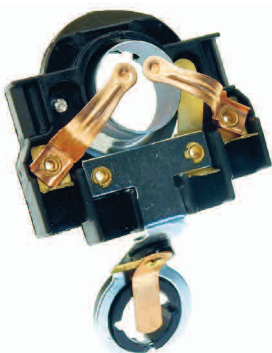

ART. 1894 PORTALAMPADA **SIEM** ADATTABILE A FANALE ANTERIORE

(RICAMBIO PER / SPARE FOR: CIF 1704-OR / 1706-OR / 1710-OR)
VESPA 50SS - 90 SS - 125 ('65-'66) - 125 SUPER
VESPA 150 SUPER ('66->) - 125 PRIMAVERA - ET3
VESPA 125 ('62-'65) - VESPA 150 ('59-'65) - GS ('59-'64)
VESPA GL ('59-'62) - VESPA GTR - TS 125
VESPA SPRINT VELOCE 150 - RALLY 180-200



ART. 1895 PORTALAMPADA **SIEM** ADATTABILE A FANALE ANTERIORE

(RICAMBIO PER / SPARE FOR : CIF 1714-OR)
VESPA PX PE 125-150-200
VESPA PX PE 125-150-200 ARCOBALENO

CORNICI FARO

HEADLIGHT RIMS



ART. **7350-C** VESPA 50 SPECIAL V5A2 (6V) (Sim. 124200)
 VESPA 50 ELESTART V5A3 12V)

ricambio per / spare for CIF ART. 1700 / 1700-OR



CORNICI FARO ORIGINALI SIEM

ORIGINAL SIEM HEADLIGHT RIMS

CROMATURA ALTA QUALITA'

HIGH QUALITY CHROME



ART. **7330-OR** VESPA 125 dal 1948 al 1951
 FANALE SUL PARAFANGO

ricambio per / spare for CIF ART. 1701-OR

CORNICE/GHIERA MARCATA SIEM SIEM MARKED RIM

PER FANALE ANTERIORE / FOR HEADLIGHT **Ø mm. 95**



ART. **7331-OR** VESPA 125 VM1T ('53) (Sim. 018088)
 VESPA 125 VM2T ('54)

ricambio per / spare for CIF ART. 1707-OR

CORNICE/GHIERA MARCATA SIEM SIEM MARKED RIM

PER FANALE ANTERIORE / FOR HEADLIGHT **Ø mm.105**



CORNICI FARO ORIGINALI SIEM
ORIGINAL SIEM HEADLIGHT RIMS



CROMATURA ALTA QUALITA'
HIGH QUALITY CHROME



ART.7334-OR VESPA 125 VN1T ('55) (Sim. 026009)
VESPA 125 VN2T ('56)

ricambio per / spare for CIF ART. 1717-OR

CORNICE/GHIERA MARCATA SIEM SIEM MARKED RIM

PER FANALE ANTERIORE / FOR HEADLIGHT Ø mm.105



ART.7333-OR VESPA 125 VNA1T ('58) (Sim.1R000194-082079)
VESPA 125 VNA2T ('58-'59)
VESPA 125 VNB1T ('60)
VESPA 125 VNB2T ('61)

ricambio per / spare for CIF ART. 1705-OR

CORNICE/GHIERA MARCATA SIEM SIEM MARKED RIM

PER FANALE ANTERIORE / FOR HEADLIGHT Ø mm.105



ART.7343-OR VESPA 125 ('62-'65) (Sim.1R000189-084489)
VESPA 150 ('59-'65)
VESPA GS ('59-'64)
VESPA GL ('59-'62)

ricambio per / spare for CIF ART. 1706-OR

CORNICE/GHIERA MARCATA SIEM SIEM MARKED RIM

PER FANALE ANTERIORE / FOR HEADLIGHT Ø mm.115



CORNICI FARO

HEADLIGHT RIMS

CROMATURA ALTA QUALITA'

HIGH QUALITY CHROME



ART.7347-OR VESPA 125 GT - 150 GL (Sim.1R000186-070543)
VESPA 150 SPRINT
VESPA 180 SUPER SPORT

ricambio per / spare for CIF ART. 1708-OR

CORNICE/GHIERA MARCATA SIEM

SIEM MARKED RIM



ART.7397-OR VESPA 125 GTR - TS (Sim.1R000185-113891)
VESPA 150 SPRINT VELOCE
RALLY 180 - 200

ricambio per / spare for CIF ART. 1710-OR

CORNICE/GHIERA MARCATA SIEM

SIEM MARKED RIM

PER FANALE ANTERIORE / FOR HEADLIGHT Ø mm.130



ART.7335-OR VESPA 150 VL1 ('55) (Sim.1R000196-023444)

ricambio per / spare for CIF ART. 1718-OR

CORNICE/GHIERA MARCATA SIEM

SIEM MARKED RIM

PER FANALE ANTERIORE / FOR HEADLIGHT Ø mm.105



CORNICI FARO ORIGINALI SIEM
ORIGINAL SIEM HEADLIGHT RIMS



CROMATURA ALTA QUALITA'
HIGH QUALITY CHROME



ART.7332-OR VESPA 150 VL2T ('55-'56) (Sim.1R000193-025092)
VESPA 150 VL3T ('56)

ricambio per / spare for CIF ART. 1715-OR / 1716-OR

CORNICE/GHIERA MARCATA SIEM **SIEM MARKED RIM**

PER FANALE ANTERIORE / FOR HEADLIGHT Ø mm.105



ART.7344-OR VESPA GS 150 VS1T ('55) (Sim.1R000191-025576)
VESPA 150 VB1T ('57-'58)
VESPA GS 150 VS 1/2/3/4 ('56-'58)

ricambio per / spare for CIF ART. 1719-OR / 1720-OR

CORNICE/GHIERA MARCATA SIEM **SIEM MARKED RIM**

PER FANALE ANTERIORE / FOR HEADLIGHT Ø mm.115

PALPEBRA CROMATA PER CORNICE FARO
CHROMED VISOR FOR HEADLIGHT RIM



ART.7339-OR VESPA 150 VL3T ('56) (Sim.025479)
VESPA 150 VB1T ('57-'58)
VESPA GS 150 VS 2/3/4/T ('56-'58)

ricambio per / spare for CIF ART. 1716-OR / 1720-OR

PALPEBRA CROMATA MARCATA SIEM **CHROMED VISOR, SIEM MARKED**



FANALI POSTERIORI ORIG. SIEM ORIGINAL SIEM TAILLIGHTS



Vespa 50 1ª serie dal 1963



OMOLOGAZIONE - APPROVAL
IGM3082LP

ART.1760-OR FANALE COMPLETO

(Sim. 073060)



- | | |
|--|--------------------------------------|
| ✓ CARCASSA ALLUMINIO NATURALE MARCATA SIEM | ALUMINIUM CARCASE SIEM MARKED |
| ✓ CORPO LUMINOSO MARCATO SIEM | LIGHT BODY SIEM MARKED |
| ✓ GUARNIZIONE ESTERNA MARCATA SIEM INCLUSA | EXTERNAL GASKET SIEM MARKED INCLUDED |
| ✓ GUARNIZIONE INTERNA MARCATA SIEM INCLUSA | INTERNAL GASKET SIEM MARKED INCLUDED |



ART.1796-OR KIT CORPO LUMINOSO+GUARNIZIONE

(Sim. 78715)

- | | |
|---|--|
| ✓ CORPO LUMINOSO MARCATO SIEM | LIGHT BODY SIEM MARKED |
| ✓ GUARNIZIONE BIANCA INTERNA MARCATA SIEM INCLUSA | INSIDE WHITE GASKET SIEM MARKED INCLUDED |



Vespa dal V5A1T esemplari fino al '66-'67

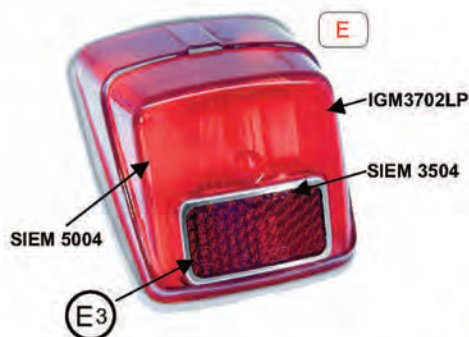

OMOLOGAZIONE - APPROVAL
IGM3702LP

ART.1763-OR FANALE COMPLETO

(Sim. 102459)



- | | |
|--|--------------------------------------|
| ✓ CORPO LUMINOSO MARCATO SIEM | LIGHT BODY SIEM MARKED |
| ✓ GUARNIZIONE ESTERNA MARCATA SIEM INCLUSA | EXTERNAL GASKET SIEM MARKED INCLUDED |



FANALI POSTERIORI ORIG. SIEM
ORIGINAL SIEM TAILLIGHTS



Vespa 50 Special (dal 1972)

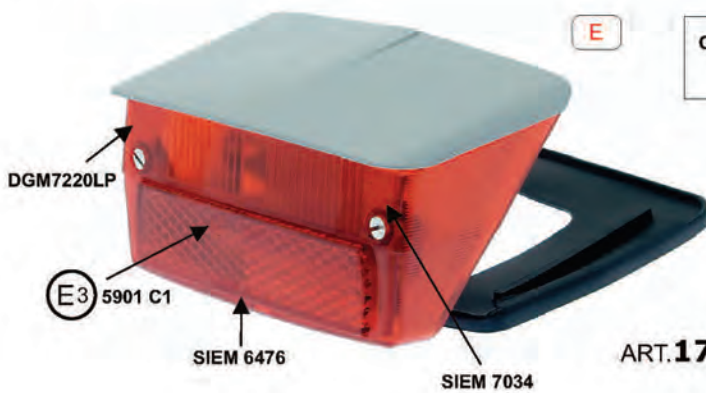

OMOLOGAZIONE - APPROVAL
DGM7220LP

ART.1765-OR FANALE COMPLETO CON VISIERA GRIGIA
COMPLETE WITH GREY VISOR

(Sim. 143687)

- ✓ CORPO LUMINOSO MARCATO SIEM
- ✓ GUARNIZIONE ESTERNA INCLUSA

LIGHT BODY SIEM MARKED
EXTERNAL GASKET INCLUDED

Vespa 50 Special (dal 1969 al 1971-72)



ART.1799-N VISIERA COLORE NERO
BLACK VISOR

(Sim. 143594)



ART.1799-CARB VISIERA EFFETTO CARBONIO
LOOK CARBONIO VISOR



FANALI POSTERIORI ORIG. SIEM ORIGINAL SIEM TAILLIGHTS



**Vespa 90 - Sprint 90 - Vespa 125
125 Primavera ('63-'66)**



OMOLOGAZIONE - APPROVAL
IGM3059LPX

ART. **1767-OR** FANALE COMPLETO

(Sim. 078641)

- | | | |
|-------------------------------------|--|--------------------------------------|
| <input checked="" type="checkbox"/> | CARCASSA ALLUMINIO NATURALE MARCATA SIEM | ALUMINIUM CARCASE SIEM MARKED |
| <input checked="" type="checkbox"/> | CORPO LUMINOSO MARCATO SIEM | LIGHT BODY SIEM MARKED |
| <input checked="" type="checkbox"/> | GUARNIZIONE ESTERNA MARCATA SIEM INCLUSA | EXTERNAL GASKET SIEM MARKED INCLUDED |
| <input checked="" type="checkbox"/> | GUARNIZIONE INTERNA MARCATA SIEM INCLUSA | INTERNAL GASKET SIEM MARKED INCLUDED |

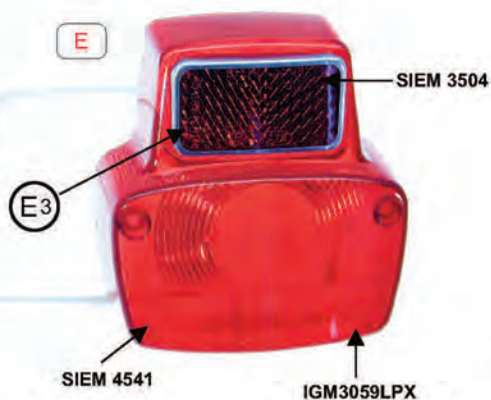

OMOLOGAZIONE - APPROVAL
IGM3059LPX

ART. **1797-OR** KIT CORPO LUMINOSO+GUARNIZIONE

(Sim. 078627)

- | | | |
|-------------------------------------|---|--|
| <input checked="" type="checkbox"/> | CORPO LUMINOSO MARCATO SIEM | LIGHT BODY SIEM MARKED |
| <input checked="" type="checkbox"/> | GUARNIZIONE BIANCA INTERNA MARCATA SIEM INCLUSA | INTERNAL WHITE GASKET SIEM MARKED INCLUDED |



FANALI POSTERIORI ORIG. SIEM

ORIGINAL SIEM TAILLIGHTS



Vespa 125 PRIMAVERA - ET3

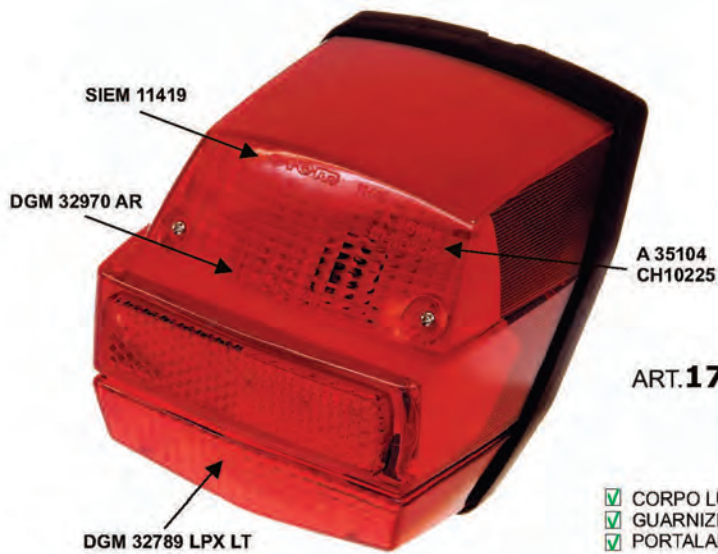

OMOLOGAZIONE - APPROVAL
SIEM 11419
DGM 32790 AR
DGM 32789 LPX LT

ART.1769-OR FANALE COMPLETO

(Sim. 148881)

- ✓ CORPO LUMINOSO MARCATO SIEM
- ✓ GUARNIZIONE MARCATO SIEM INCLUSA
- ✓ PORTALAMPADA INCLUSO

LIGHT BODY SIEM MARKED
GASKET SIEM MARKED INCLUDED
BULB SOCKET INCLUDED

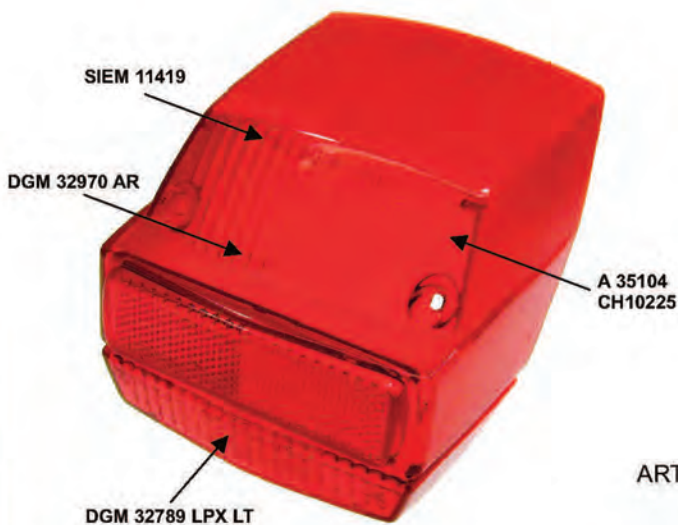

OMOLOGAZIONE - APPROVAL
SIEM 11419
DGM 32790 AR
DGM 32789 LPxLT

ART.1793-OR CORPO LUMINOSO

(Sim. 159431)

- ✓ CORPO LUMINOSO MARCATO SIEM

LIGHT BODY SIEM MARKED



FANALI POSTERIORI ORIG. SIEM ORIGINAL SIEM TAILLIGHTS



VESPA PK 50 ('82-'84) - PK S 50 ('84-'89)

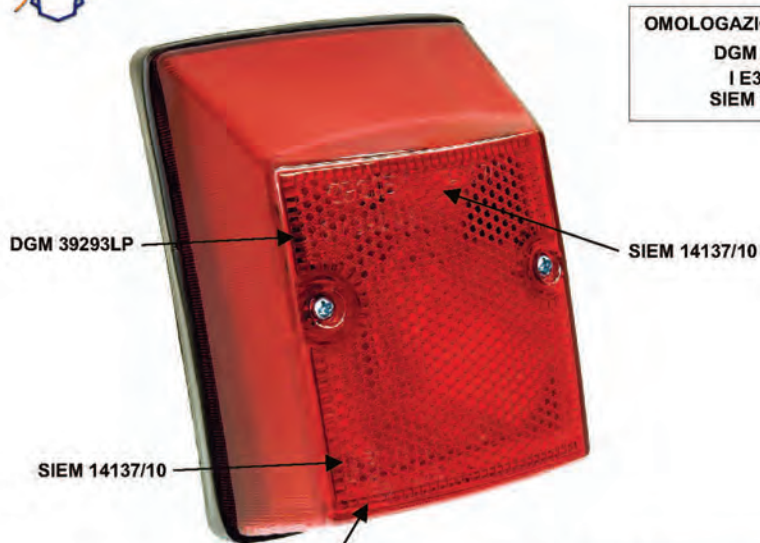

OMOLOGAZIONE - APPROVAL
DGM 39293LP
I E3 39289
SIEM 14137/10



I (E3) 39289

ART. **1772-OR** FANALE COMPLETO

(Sim. 216444)

- ✓ CARCASSA PLASTICA CROMATA MARCATA SIEM
- ✓ CORPO LUMINOSO MARCATO SIEM
- ✓ GUARNIZIONE MARCATA SIEM INCLUSA

- CHROMED PLASTIC CARCASE SIEM MARKED
- LIGHT BODY SIEM MARKED
- GASKET SIEM MARKED INCLUDED



VESPA PK 50 XL - RUSH



OMOLOGAZIONE - APPROVAL
I E3 31209 - II E3 4692 02
SIEM 2020



I (E3) 31209

II (E3) 4692 02

ART. **1774-OR** FANALE COMPLETO

(Sim. 234225)

- ✓ CARCASSA PLASTICA CROMATA
- ✓ CORPO LUMINOSO MARCATO SIEM
- ✓ GUARNIZIONE MARCATA SIEM INCLUSA

- CHROMED PLASTIC CARCASE
- LIGHT BODY SIEM MARKED
- GASKET SIEM MARKED INCLUDED



FANALI POSTERIORI ORIG. SIEM
ORIGINAL SIEM TAILLIGHTS



VESPA PK 125 - 125S - 125 S AUTOMATICA
VESPA PK 80-100

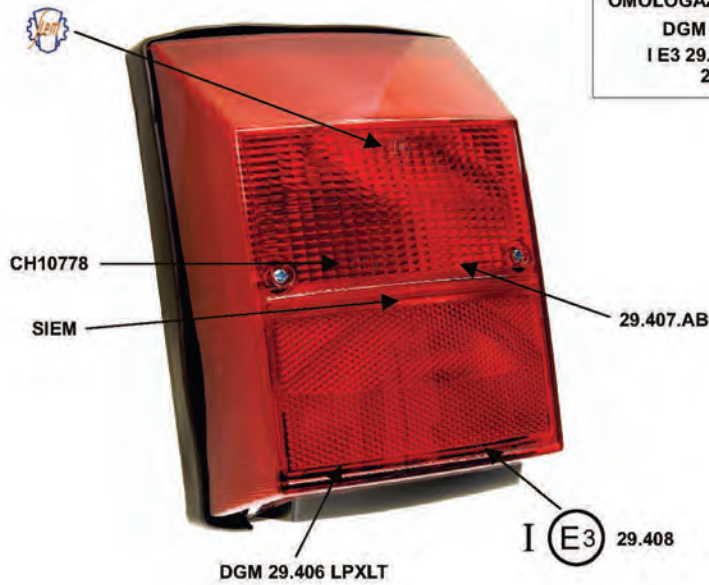

OMOLOGAZIONE - APPROVAL
DGM 29.406 LPXLT
I E3 29.408 - CH 10778
29.407.AB



ART.1775-OR FANALE COMPLETO

(Sim. 2159661)

- ✓ CARCASSA PLASTICA CROMATA MARCATA SIEM
- ✓ CORPO LUMINOSO MARCATO SIEM
- ✓ GUARNIZIONE MARCATA SIEM INCLUSA
- ✓ FINESTRA PER LUCE TARGA

- CHROMED PLASTIC CARCASE SIEM MARKED
- LIGHT BODY SIEM MARKED
- GASKET SIEM MARKED INCLUDED
- NUMBER PLATE LIGHT WINDOWS



FANALI POSTERIORI ORIG. SIEM
ORIGINAL SIEM TAILLIGHTS



Vespa P125-150X - P200E - PX 125-150-200E

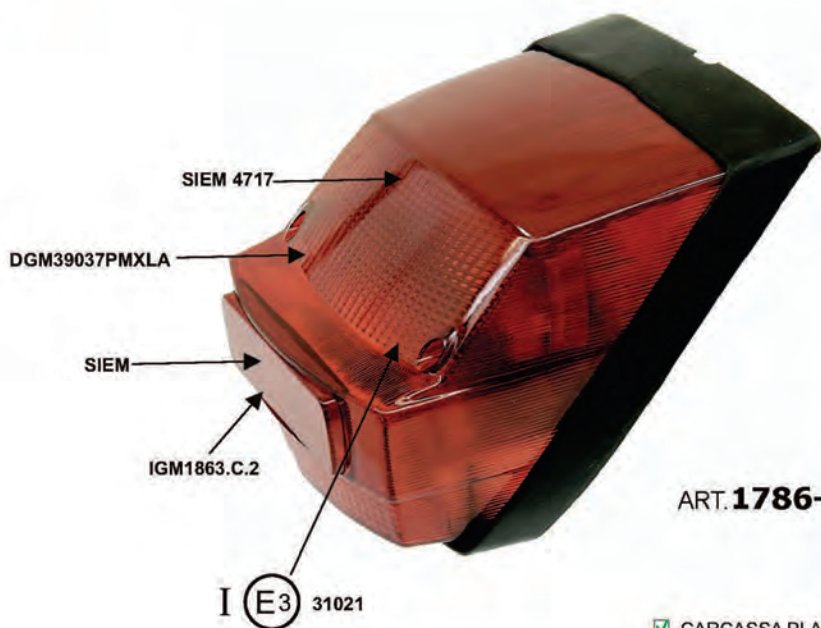

OMOLOGAZIONE - APPROVAL
DGM 39037PMXLA
SIEM 4717

ART.1786-OR FANALE COMPLETO
(Sim. ????)

- | | |
|---|--|
| ✓ CARCASSA PLASTICA CROMATA
MARCATA SIEM | CHROMED PLASTIC CARCASE
SIEM MARKED |
| ✓ CORPO LUMINOSO MARCATO SIEM | LIGHT BODY SIEM MARKED |
| ✓ GUARNIZIONE INCLUSA | GASKET INCLUDED |

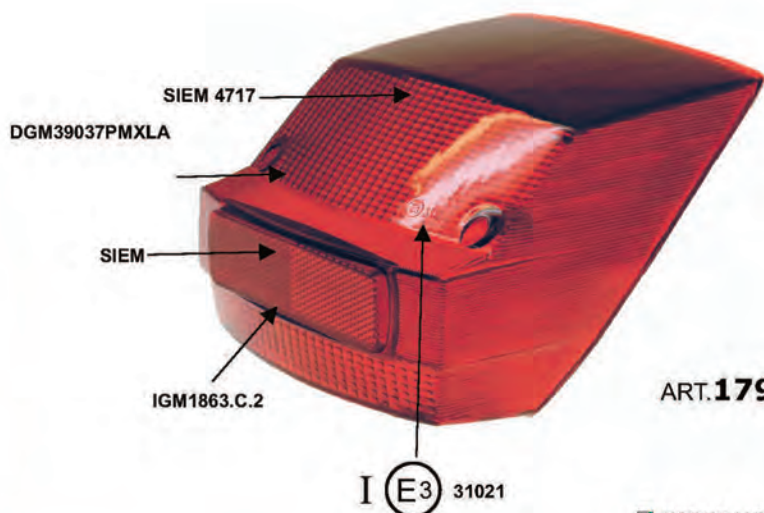

OMOLOGAZIONE - APPROVAL
DGM 39037PMXLA
SIEM 4717

ART.1790-OR CORPO LUMINOSO
(Sim. 162741)

- | | |
|-------------------------------|------------------------|
| ✓ CORPO LUMINOSO MARCATO SIEM | LIGHT BODY SIEM MARKED |
|-------------------------------|------------------------|



FANALI POSTERIORI ORIG. SIEM

ORIGINAL SIEM TAILLIGHTS



Vespa PX 125-150-200E ARCOBALENO

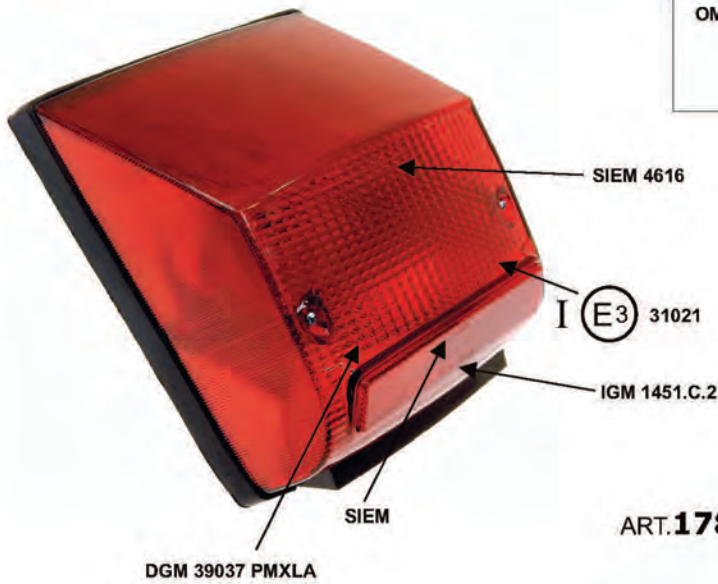

OMOLOGAZIONE - APPROVAL
DGM 39037 PMXLA
I E3 31021
SIEM 4616



ART.1788-OR FANALE COMPLETO
(Sim. 219091)

- ✓ CARCASSA PLASTICA CROMATA
- ✓ CORPO LUMINOSO MARCATO SIEM
- ✓ GUARNIZIONE
- ✓ FINESTRA PER LUCE TARGA

CHROMED PLASTIC CARCASE
LIGHT BODY SIEM MARKED
GASKET
NUMBER PLATE LIGHT WINDOWS

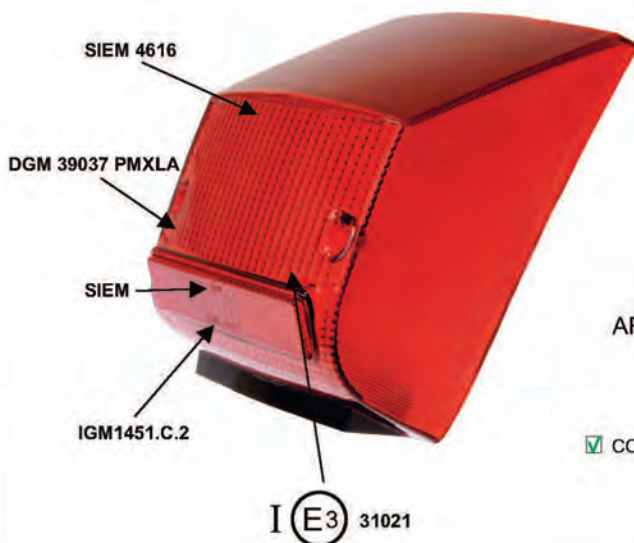

OMOLOGAZIONE - APPROVAL
DGM 39037 PMXLA
I E3 31021 - IGM 1451.C.2
SIEM 4616

ART.1791-OR CORPO LUMINOSO
(Sim. 219094)

- ✓ CORPO LUMINOSO MARCATO SIEM

LIGHT BODY SIEM MARKED



FANALI POSTERIORI ORIG. SIEM
ORIGINAL SIEM TAILLIGHTS



Vespa PX 125-150 (2011-2017)

OMOLOGAZIONE - APPROVAL
DGM 39037 PMXLA
I E3 31021 - IGM1451.C.2

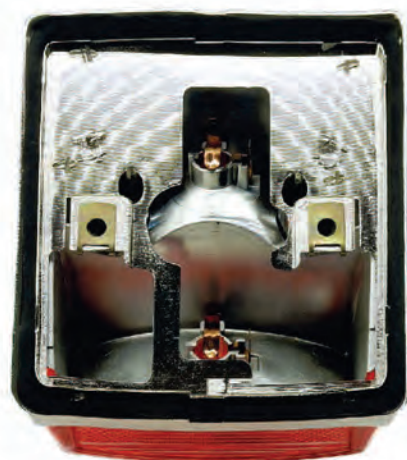

ART.1787-OR FANALE COMPLETO

(Sim. 58269R)

- ✓ CORPO LUMINOSO MARCATO SIEM
- ✓ GUARNIZIONE INCLUSA

LIGHT BODY SIEM MARKED
GASKET INCLUDED



ART. 1419
LAMPADINA - BULB
Ba15 s (12V 10W)



ART. 1418
LAMPADINA - BULB
BA15 s (12V 5 W)



FANALI POSTERIORI ORIG. SIEM

ORIGINAL SIEM TAILLIGHTS



**Vespa 125 GTR (dal '70) - TS 125 (VNL3T) - SPRINT VELOCE 150
RALLY 180 (dal '68) - RALLY 200**

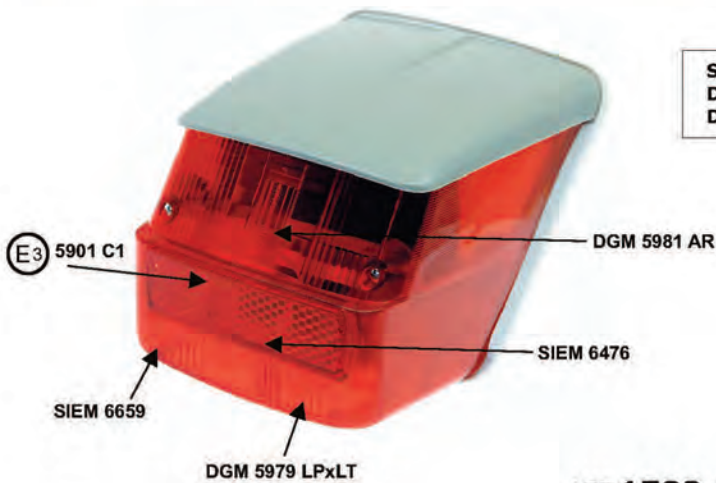

**SIEM 6659
DGM 5979 LPxLT
DGM 5981 AR**



ART.1782-OR FANALE COMPLETO

(Sim. 121017)

- ✓ CORPO LUMINOSO MARCATO SIEM
- ✓ GUARNIZIONE MARCATATA SIEM INCLUSA
- ✓ PORTALAMPADA INCLUSO
- ✓ VISIERA COLORE GRIGIO NEUTRO DA VERNICIARE

- LIGHT BODY SIEM MARKED
- GASKET SIEM MARKED INCLUDED
- BULB SOCKET INCLUDED
- NEUTRAL GREY VISOR TO PAINT

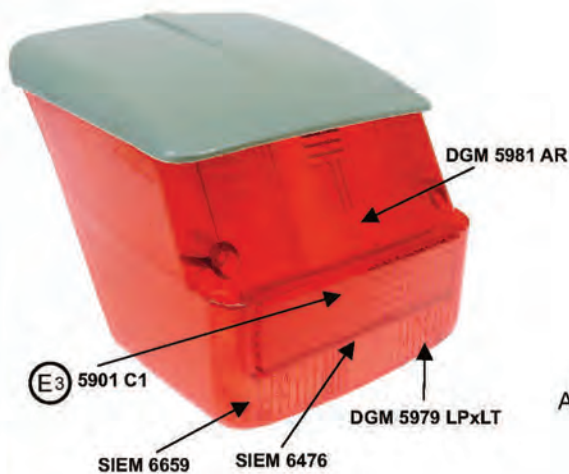

**SIEM 6659
DGM 5979 LPxLT
DGM 5981 AR**

ART.1798-OR CORPO LUMINOSO CON VISIERA GRIGIA
LIGHT BODY WITH GREY VISOR

- ✓ CORPO LUMINOSO MARCATO SIEM
- ✓ VISIERA COLORE GRIGIO NEUTRO DA VERNICIARE

- LIGHT BODY SIEM MARKED
- NEUTRAL GREY VISOR TO PAINT



FANALI POSTERIORI ORIG. SIEM
ORIGINAL SIEM TAILLIGHTS



Vespa Rally (VSD1)



ART. 1781-OR FANALE COMPLETO CON VISIERA NERA
COMPLETE TAILLIGHT WITH BLACK VISOR
(Sim. 121017)

- ✓ CORPO LUMINOSO MARCATO SIEM
- ✓ GUARNIZIONE NERA MARCATO SIEM INCLUSA
- ✓ PORTALAMPADA INCLUSO
- ✓ VISIERA NERA

- LIGHT BODY SIEM MARKED
- BLACK GASKET SIEM MARKED INCLUDED
- BULB SOCKET INCLUDED
- BLACK VISOR



FANALI POSTERIORI ORIG. SIEM
ORIGINAL SIEM TAILLIGHTS



Vespa Super 125-150 (dal '66)
Vespa Sprint 150 (65-'74) - Vespa 180 SS ('65-'68)

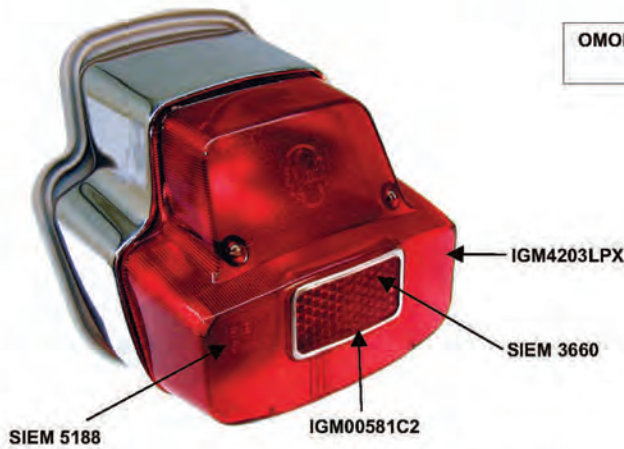

OMOLOGAZIONE - APPROVAL
IGM4203LPX

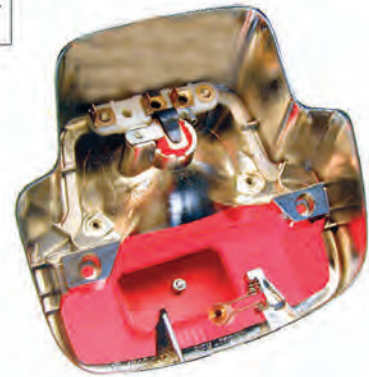

ART.1785-OR FANALE COMPLETO

- ✓ CARCASSA METALLO CROMATA MARCATA SIEM CHROMED METAL CARCASE SIEM MARKED
- ✓ CORPO LUMINOSO MARCATO SIEM LIGHT BODY SIEM MARKED
- ✓ GUARNIZIONE ESTERNA MARCATA SIEM INCLUSA EXTERNAL GASKET SIEM MARKED INCLUDED
- ✓ GUARNIZIONE INTERNA MARCATA SIEM INCLUSA INSIDE GASKET SIEM MARKED INCLUDED

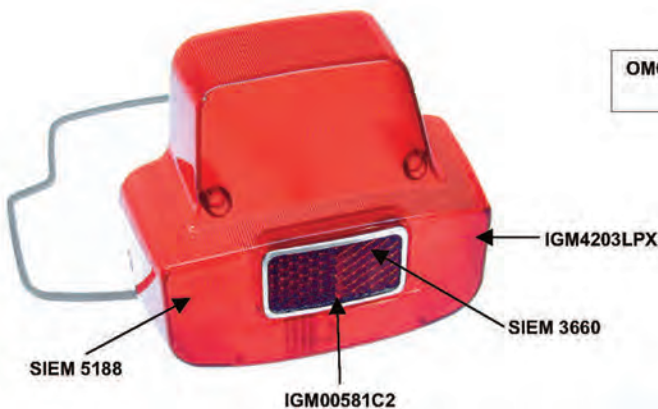

OMOLOGAZIONE - APPROVAL
IGM4203LPX

ART.1784-OR KIT CORPO LUMINOSO + GUARNIZIONE
(Sim. 150369)

- ✓ CORPO LUMINOSO MARCATO SIEM LIGHT BODY SIEM MARKED
- ✓ GUARNIZIONE INTERNA MARCATA SIEM INCLUSA INSIDE GASKET SIEM MARKED INCLUDED



FANALI POSTERIORI ORIG. SIEM

ORIGINAL SIEM TAILLIGHTS



**Vespa 125 (dal '65) - Super 125-150 (dal '66)
GL e SPRINT 150 ('64-'66) - 180 SS (fino al 1965)**

OMOLOGAZIONE - APPROVAL
IGM2817LPX

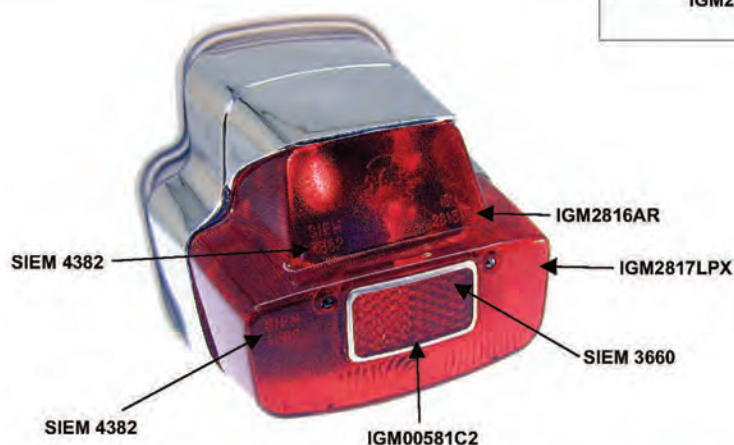

ART.1780-OR FANALE COMPLETO
(Sim. 091488)

- | | |
|--|--------------------------------------|
| <input checked="" type="checkbox"/> CARCASSA METALLO CROMATA MARCATA SIEM | CHROMED METAL CARCASE SIEM MARKED |
| <input checked="" type="checkbox"/> CORPO LUMINOSO MARCATO SIEM | LIGHT BODY SIEM MARKED |
| <input checked="" type="checkbox"/> GUARNIZIONE ESTERNA MARCATA SIEM INCLUSA | EXTERNAL GASKET SIEM MARKED INCLUDED |
| <input checked="" type="checkbox"/> GUARNIZIONE INTERNA MARCATA SIEM INCLUSA | INSIDE GASKET SIEM MARKED INCLUDED |

OMOLOGAZIONE - APPROVAL
IGM2817LPX



ART.1795-OR KIT CORPO LUMINOSO + GUARNIZIONE
(Sim. 097440)

- | | |
|--|------------------------------------|
| <input checked="" type="checkbox"/> CORPO LUMINOSO MARCATO SIEM | LIGHT BODY SIEM MARKED |
| <input checked="" type="checkbox"/> GUARNIZIONE INTERNA MARCATA SIEM INCLUSA | INSIDE GASKET SIEM MARKED INCLUDED |



FANALI POSTERIORI ORIG. SIEM

ORIGINAL SIEM TAILLIGHTS



Vespa 125 ('60-'64) - Vespa 150 ('59-'65)
Vespa GS 150 ('59-'64) - Vespa GL 150 ('59-'64)

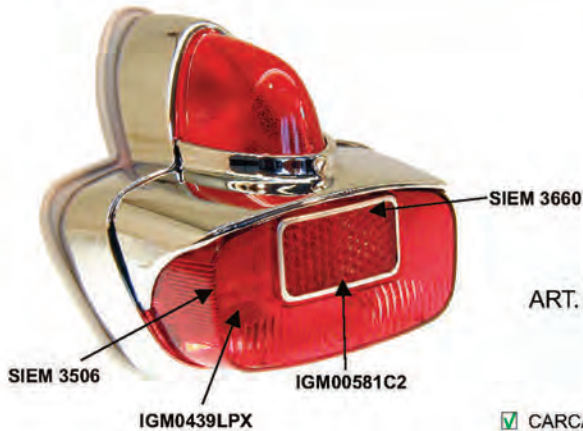

OMOLOGAZIONE - APPROVAL
IGM0439LPX

ART. 1778-OR FANALE COMPLETO
(Sim. 089442)



- ✓ CARCASSA METALLO CROMATA MARCATA SIEM
 - ✓ CORPO LUMINOSO MARCATO SIEM
 - ✓ GUARNIZIONE ESTERNA MARCATA SIEM INCLUSA
 - ✓ GUARNIZIONE INTERNA MARCATA SIEM INCLUSA
- CHROMED METAL CARCASE SIEM MARKED
LIGHT BODY SIEM MARKED
EXTERNAL GASKET SIEM MARKED INCLUDED
INSIDE GASKET SIEM MARKED INCLUDED

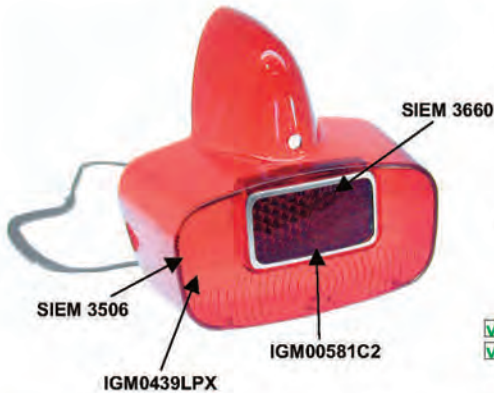

ART. 1794-OR KIT CORPO LUMINOSO + GUARNIZIONE
(Sim. 089441-89818)

- ✓ CORPO LUMINOSO MARCATO SIEM
 - ✓ GUARNIZIONE INTERNA MARCATA SIEM INCLUSA
- LIGHT BODY SIEM MARKED
INSIDE GASKET SIEM MARKED INCLUDED



Vespa 125 VN 1-2 - VNA 1-2 ('58) - 150 VL1-2-3-VB1 ('58)
Vespa GS 150 VS 1-2-3 ('58)

OMOLOGAZIONE - APPROVAL
IGM CN1228-5-5-1955



ART. 1783-OR FANALE COMPLETO
(Sim. 021098)



- ✓ CARCASSA IN ALLUMINIO MARCATA SIEM
 - ✓ CORPO LUMINOSO MARCATO SIEM
 - ✓ GUARNIZIONE ESTERNA MARCATA SIEM INCLUSA
- ALUMINIUM CARCASE SIEM MARKED
LIGHT BODY SIEM MARKED
EXTERNAL GASKET SIEM MARKED INCLUDED



FANALI POSTERIORI ORIG. SIEM

ORIGINAL SIEM TAILLIGHTS



Vespa GS 150 (VBA1T DAL TELAIO / FROM CHASSIS N.1001 -> N.110485)
Vespa GS 150 (VS4T DAL TELAIO / FROM CHASSIS N.0035311 AL 0087589)

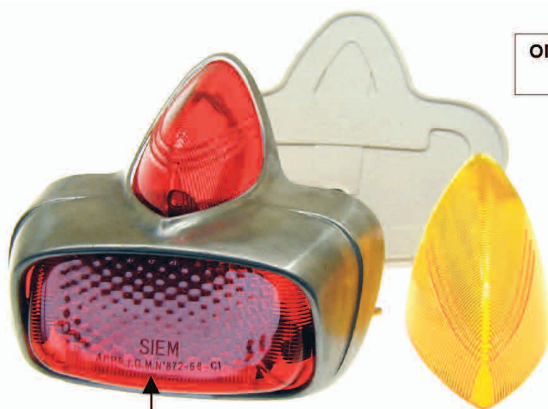

IGM872-58-C1

OMOLOGAZIONE - APPROVAL
IGM872-58-C1



ART. **1777-OR** FANALE COMPLETO

- | | |
|--|----------------------------|
| <input checked="" type="checkbox"/> CARCASSA ALLUMINIO | ALUMINIUM CARCASE |
| <input checked="" type="checkbox"/> CORPO LUMINOSO MARCATO SIEM | LIGHT BODY SIEM MARKED |
| <input checked="" type="checkbox"/> GUARNIZIONE ESTERNA | EXTERNAL GASKET |
| MARCATO SIEM INCLUSA | SIEM MARKED INCLUDED |
| <input checked="" type="checkbox"/> GOCCIA ARANCIONE SUPPLEMENTARE INCLUSA | ORANGE DROP EXTRA INCLUDED |



Vespa GS 150 (VBA1T) - Vespa GS 150 (VS4T)
PRODUZIONI / PRODUCTIONS 1958

ART. **1792-A** GOCCIA ARANCIONE PER FANALE POST. SIEM
(RICAMBIO PER / SPARE FOR CIF ART. 1777-OR)



Vespa GS 150 (VBA1T) - Vespa GS 150 (VS4T)
PRODUZIONI DAL / PRODUCTIONS SINCE 1959

ART. **1792-R** GOCCIA ROSSA PER FANALE POST. SIEM
(RICAMBIO PER / SPARE FOR CIF ART. 1777-OR)

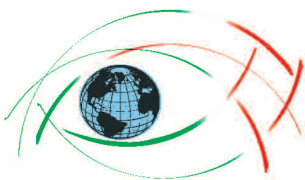

COPPIE FRECCE SIEM SIEM INDICATOR LENSES



Vespa PK 50/125 - PK 50/80/100/125 S



OMOLOGAZIONE - APPROVAL
49850

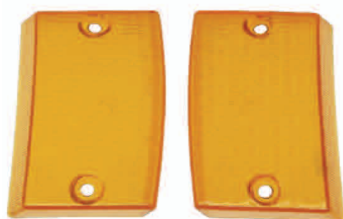

ART.1736-OR CP.FRECCE **ANTERIORI**
PAIR OF **FRONT** INDICATOR LENSES
(Sim. 216782+216783)

PLASTICA MARCATA SIEM PLASTIC SIEM MARKED

ART.1738-OR CP. PLASTICHE PER FRECCE **ANTERIORI**
PAIR OF **FRONT** PLASTIC FOR INDICATOR LENSES
(Sim.)

PLASTICA MARCATA SIEM PLASTIC SIEM MARKED



ART. 1419 LAMPADINA - BULB BA15 s (12V 10W)
PER FRECCE ANTERIORI / POSTERIORI
FOR FRONT/REAR INDICATOR LENSES



OMOLOGAZIONE - APPROVAL
49840
SIEM 21.31.12D/S



ART.1737-OR CP.FRECCE **POSTERIORI**
PAIR OF **REAR** INDICATOR LENSES
(Sim. 216784+216785)

PLASTICA MARCATA SIEM PLASTIC SIEM MARKED

ART.1739-OR CP. PLASTICHE PER FRECCE **POSTERIORI**
PAIR OF **REAR** PLASTIC FOR INDICATOR LENSES
(Sim.)

PLASTICA MARCATA SIEM PLASTIC SIEM MARKED



COPPIE FRECCHE SIEM

SIEM INDICATOR LENSES



Vespa PK 50/125 XL - 50 RUSH - N - FL2 - HP - V



OMOLOGAZIONE - APPROVAL
50R0043162
SIEM 17942D-17943S

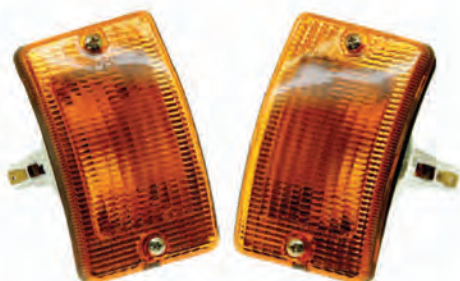

ART. **1740-OR** CP.FRECCHE **ANTERIORI**
PAIR OF **FRONT** INDICATOR LENSES
(Sim. 233970+233971)

PLASTICA MARCATA SIEM PLASTIC SIEM MARKED



ART. **1742-OR** CP. PLASTICHE PER FRECCHE **ANTERIORI**
PAIR OF **FRONT** PLASTIC FOR INDICATOR LENSES
(Sim. 234772+234769)

PLASTICA MARCATA SIEM PLASTIC SIEM MARKED



ART. **1419** LAMPADINA - BULB BA15 s (12V 10W)
PER FRECCHE ANTERIORI / POSTERIORI
FOR FRONT/REAR INDICATOR LENSES



OMOLOGAZIONE - APPROVAL
50R0043164
SIEM 701235-D-701236-S



ART. **1741-OR** CP.FRECCHE **POSTERIORI**
PAIR OF **REAR** INDICATOR LENSES
(Sim. 233061+233065)

PLASTICA MARCATA SIEM PLASTIC SIEM MARKED



ART. **1743-OR** CP. PLASTICHE PER FRECCHE **POSTERIORI**
PAIR OF **REAR** PLASTIC FOR INDICATOR LENSES
(Sim. 234778-234774)

PLASTICA MARCATA SIEM PLASTIC SIEM MARKED



KIT FRECCHE SIEM

SIEM INDICATOR LENSES KIT



Vespa P125-150X - PX 125-150-200E
Vespa PX 125-150-200 ARCOBALENO - 125 T5



E3

OMOLOGAZIONE - APPROVAL
33479
SAE D77 DOT - SIEM 11835
SAE D77 DOT - SIEM 11836
33480
SAE D77 DOT - SIEM 11901
SAE D77 DOT - SIEM 11902

ART.1751-OR KIT FRECCHE (4 pz.) SIEM OMOLOGATE
ANTERIORI + POSTERIORI
TIPO LUSO CON CORNICE CROMATA

INDICATOR LENSES KIT (4 pcs.)
SIEM APPROVED, **FRONT + REAR**
LUXURY TYPE WITH CHROMED RIM

✓ PLASTICA MARCATA SIEM PLASTIC SIEM MARKED



ART. 1420-FR

LAMPADINA - BULB Ba15 s (12V 21W)
PER FRECCHE ANTERIORI / POSTERIORI
FOR FRONT/REAR INDICATOR LENSES

mm.15



E3

OMOLOGAZIONE - APPROVAL
33479
SAE D77 DOT - SIEM 11835
SAE D77 DOT - SIEM 11836
33480
SAE D77 DOT - SIEM 11901
SAE D77 DOT - SIEM 11902

ART.1750-OR **KIT** PLASTICHE PER FRECCHE (4 pz.)
SIEM OMOLOGATE
ANTERIORI + POSTERIORI
(RICAMBIO PER NS. ART. 1751-OR)

PLASTICS **KIT** (4 pcs.)
SIEM APPROVED **FRONT + REAR**
(SPARE FOR OUR CODE 1751-OR)

✓ PLASTICA MARCATA SIEM PLASTIC SIEM MARKED



COPPIE FRECCHE SIEM

SIEM INDICATOR LENSES PAIR



Vespa P125-150X - PX 125-150-200E
Vespa PX 125-150-200 ARCOBALENO - 125 T5

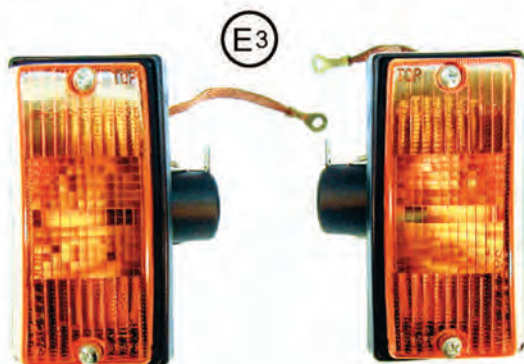

ART.1730-OR CP.FRECCHE **ANTERIORI**
PAIR OF **FRONT** INDICATOR LENSES
(Sim. 163256+162817)

✓ PLASTICA MARCATA SIEM PLASTIC SIEM MARKED

OMOLOGAZIONE - APPROVAL
33479
SAE D77 DOT - SIEM 11835
SAE D77 DOT - SIEM 11836



ART. 1420-FR
LAMPADINA - BULB Ba15 s (12V 21W)
PER FRECCHE ANTERIORI / POSTERIORI
FOR FRONT/REAR INDICATOR LENSES

mm.15



ART.1731-OR CP.FRECCHE **POSTERIORI**
PAIR OF **REAR** INDICATOR LENSES
(Sim. 230338+230339)

✓ PLASTICA MARCATA SIEM PLASTIC SIEM MARKED

OMOLOGAZIONE - APPROVAL
33480
SAE D77 DOT - SIEM 11901
SAE D77 DOT - SIEM 11902





COPPIE FRECCE SIEM SIEM INDICATOR LENSES PAIR



Vespa PX 30 ANNI 125 ('07-'08) - PX 125-150 ('11-'17)

adattabile a / suitable to :
VESPA P125-150 X - PX 125-150-200E
Vespa PX 125-150-200 ARCOBALENO - 125 T5
VESPA LML



E3

OMOLOGAZIONE - APPROVAL
33479
SAE D77 DOT - SIEM 11835
SAE D77 DOT - SIEM 11836

ART.1732-OR COPPIA FRECCE **ANTERIORI**
SIEM OMOLOGATE
CON CORNICE CROMATA

FRONT INDICATOR LENSES PAIR
SIEM APPROVED
WITH CHROMED RIM

(Sim. 638761-638762)

✓ PLASTICA MARCATA SIEM PLASTIC SIEM MARKED



ART. 1413-FRA

LAMPADINA - BULB Ba15 s (12V 21W)
PER FRECCE ANTERIORI / POSTERIORI

FOR FRONT/REAR INDICATOR LENSES

COLORE AMBRA / AMBER

mm.15



E3

OMOLOGAZIONE - APPROVAL
33480
SAE D77 DOT - SIEM 11901
SAE D77 DOT - SIEM 11902

ART.1733-OR COPPIA FRECCE **POSTERIORI**
SIEM OMOLOGATE
CON CORNICE CROMATA

REAR INDICATOR LENSES PAIR
SIEM APPROVED
WITH CHROMED RIM

✓ PLASTICA MARCATA SIEM PLASTIC SIEM MARKED

