



# scooter

ricambi • spare parts



# INDICE FASCICOLO SCOOTER

## SCOOTER BOOKLET INDEX

### Prodotti

**Ammortizzatori RUOTA IL CATALOGO**  
e sfoglia il fascicolo dedicato



	<b>Pag. catalogo</b>
<b>A</b> lberi motore	119->120
<b>A</b> nelli di tenuta	123->124
<b>A</b> ssi ruota anteriori	25
<b>A</b> ssi ruota posteriori	169->172
<b>B</b> locchetti avviamento	75->77
<b>B</b> occole in grafite, innesto collettore	115
<b>B</b> occoli avviamento	149
<b>B</b> ordi scudo	11->12
<b>C</b> alotte sterzo	23->24
<b>C</b> ampane frizione	161->163
<b>C</b> arburatori Dellorto e ricambi	79->92
<b>C</b> atarinfrangente	41
<b>C</b> entraline elettroniche	46
<b>C</b> inghie di trasmissione	141->147
<b>C</b> inghiette miscelatore	148
<b>C</b> omandi freno e gas	27->29
<b>C</b> omandi starter carburatore	91
<b>C</b> operchi manubrio	21
<b>C</b> operchio asse ruota posteriore	173
<b>C</b> uffia cilindro	117
<b>C</b> uscinetti a sfera albero motore	121->122
<b>C</b> uscinetti asse ruota anteriore	26
<b>C</b> uscinetti asse ruota posteriore	26+173
<b>D</b> eflettori per scudi	12
<b>D</b> ellorto Carburatori e ricambi	78->92
<b>D</b> isco freno	57
<b>E</b> mblemi/Scudetti	14->17
<b>E</b> strattore volano	121
<b>F</b> analeria	40
<b>F</b> iltri aria	97->104
<b>F</b> iltri olio	105->107
<b>G</b> abbie spinotto biella	120
<b>G</b> abbie sterzo	24
<b>G</b> anasce	58->60
<b>G</b> etti carburatore	87
<b>G</b> uarnizioni carburatori	92
<b>G</b> uarnizioni motore	113->116
<b>G</b> uarnizioni scarico	116
<b>G</b> iranti Frizione	159->168
<b>G</b> ruppi ottici	40
<b>I</b> nterruttori stop-luci-avviamento-freccie	36->39
<b>K</b> it assi ruota posteriore	169->172
<b>K</b> it modifica starter carburatori	90

### Products

### Page catalog

<b>A</b> ir Filters	97->104
<b>A</b> xle, front wheel	25
<b>A</b> xle, rear wheel	169->172
<b>B</b> earing for crankshaft	121->122
<b>B</b> earing for front axle wheel	26
<b>B</b> earing for rear axle wheel	26+173
<b>B</b> earing ball track	23->24
<b>B</b> elts driving and for automatic mix	141->148
<b>B</b> rake levers	27->28
<b>B</b> rake disc	57
<b>B</b> rake shift sleeve and brake levers	27->28
<b>B</b> rake pads (front and rear)	48->56
<b>B</b> rake shoes (front and rear)	57->60
<b>C</b> age for bearing ball track	24
<b>C</b> arburators and spare parts Dellorto	78->92
<b>C</b> overs, handlebar, front steering	21->22
<b>C</b> leaner air	97->104
<b>C</b> lutch assy	159->168
<b>C</b> lutch drum	161->163
<b>C</b> olumn covers	22
<b>C</b> ontrols throttle, holder levers, levers	27->29
<b>C</b> rankshafts	119->120
<b>C</b> ylinder cooling fan	117
<b>D</b> ellorto Carburators and spare parts	78->92
<b>D</b> iaphragms for carburetor	94->96
<b>D</b> riving Belts	141->147
<b>E</b> lectrical starter motor	42->44
<b>E</b> lectric fuel pump	112
<b>E</b> mblems	14->17
<b>F</b> loat chamber, carburetors	88
<b>F</b> ront mudguard	18->20
<b>F</b> uel cocks	108->111
<b>F</b> uel pumps	112
<b>G</b> askets set, carburetors	92
<b>G</b> askets set, engine	113->116
<b>G</b> rips	30>34
<b>H</b> alf-pulley	150->153
<b>H</b> andlebar covers	21
<b>H</b> eadlights	40
<b>K</b> IT front wheel axle	25
<b>K</b> IT rear wheel axle	169->172
<b>K</b> IT revision for crankshafts	126->136
<b>K</b> IT revision for pump H2O	137->140
<b>K</b> IT rollers	155->158
<b>I</b> gnition system	46
<b>I</b> gnition switches	75->77
<b>I</b> nlet pipe	93
<b>L</b> evers	27->28
<b>J</b> ets, carburetor	87





# INDICE FASCICOLO SCOOTER

## SCOOTER BOOKLET INDEX

### Prodotti

### Pag. catalogo

<b>K</b> it montaggio cavalletti centrali	175
<b>K</b> it scodellino+dado+coppiglia x asse ruota post.	174
<b>K</b> it revisione albero motore	126->136
<b>K</b> it revisione pompa H2O	137->140
<b>K</b> it rulli di contrasto	155->158
<b>L</b> eve	27->28
<b>M</b> anopole	30->34
<b>M</b> ascherine copristerzo	22
<b>M</b> embrane carburatore	94->96
<b>M</b> olle cavalletto	175
<b>M</b> otorini avviamento	42->44
<b>P</b> arafanghi	18->20
<b>P</b> araoli	123->124
<b>P</b> astiglie freno	48->56
<b>P</b> attini per coperchi rulli puleggia motrice	154
<b>P</b> iastrine elastiche per viti autofilettanti	47
<b>P</b> iastrine per bordi scudo	13
<b>P</b> ompe depressione ed elettriche benzina	111->112
<b>P</b> rigioniero fissa cilindro	117
<b>R</b> accordi ammissione	93
<b>R</b> accordo tubo olio	111
<b>R</b> egolatori di tensione	45
<b>R</b> invii motorino avviamento	43->44
<b>R</b> ulli di contrasto	155->158
<b>R</b> ubinetto benzina	108->111
<b>S</b> codellino asse ruota posteriore	174
<b>S</b> codetti/emblemi	14->17
<b>S</b> emipuleggie motrice	150->153
<b>S</b> erie calotte sterzo	23->24
<b>S</b> erie guarnizioni carburatore	92
<b>S</b> erie guarnizioni motore	113->116
<b>S</b> erie paraoli	125+130+131+133
<b>S</b> errature	73->77
<b>S</b> ettori avviamento	118
<b>S</b> pecchi retrovisori	05->10
<b>S</b> tarter automatici carburatore	89
<b>T</b> appo copri dado mozzi ruota	174
<b>T</b> arghette	14->17
<b>T</b> eleruttori	46
<b>T</b> erminale marmitta	20
<b>T</b> rasmissioni kontakm	63->72
<b>T</b> rasmissioni freno posteriore	61
<b>T</b> rasmissioni gas - starter	62
<b>T</b> ubi comando gas	29
<b>V</b> alvole gas carburatori	88
<b>V</b> aschette carburatori	88
<b>V</b> isiera	21
<b>V</b> iti fissaggio vaschette carburatori	88

### Products

### Page catalog

<b>M</b> irrors	05->10
<b>M</b> ixer, belts for automatic mixer	148
<b>M</b> udguards	18->20
<b>M</b> uffler terminal	20
<b>N</b> ameplates	14->17
<b>N</b> eedles, carburetor	86
<b>O</b> il filters	105->107
<b>O</b> il pipe fitting	111
<b>O</b> il seals	123->124
<b>O</b> n-off switches	74
<b>P</b> ads, brake	48->56
<b>P</b> lates, shield beading	13+47
<b>P</b> rotection for shield	12
<b>P</b> ulley, half driving	150->153
<b>P</b> ump, fuel	111->112
<b>R</b> eflector	41
<b>R</b> oller cages	120
<b>R</b> ollers set	155->158
<b>S</b> hock absorbers <b>TURN THE CATALOG</b> <i>look at the dedicate booklet</i>	
<b>S</b> ecurity lock on the steering	73
<b>S</b> elf-tapping screws plate	47
<b>S</b> et bearing ball track	23->24
<b>S</b> et gaskets set engine	113->116
<b>S</b> et oil seals	125+130+131+133
<b>S</b> hield beading	11->12
<b>S</b> hoes, brake	58->60
<b>S</b> liders	154
<b>S</b> peedometer transmissions	63->72
<b>S</b> tand springs	175
<b>S</b> tarter bushings	149
<b>S</b> tarter free wheel	43->44
<b>S</b> tarter remote switches	46
<b>S</b> tarter sectors	118
<b>S</b> tarting, horn buton and switches	36->39
<b>S</b> teering covers	22
<b>S</b> wiches, stop, starter, indicator lenses, horn,lights	36->39
<b>T</b> hrottle controls and levers	27->29
<b>T</b> ransmission, brake	61
<b>T</b> ransmission, speedometer	63->72
<b>T</b> ransmission, throttle, starter	62
<b>U</b> nit for turn signal lamps,.....	39->40
<b>V</b> isor	21
<b>V</b> oltage regulators	45
<b>W</b> ashers for bearing ball track	24
<b>W</b> heel axle bearing	26
<b>W</b> heel axle Kit	25







SCOOTER

# ammortizzatori

## shock absorbers



ruota il catalogo  
sfoglia il Fascicolo dedicato

*turn the catalog  
look at the dedicate booklet*

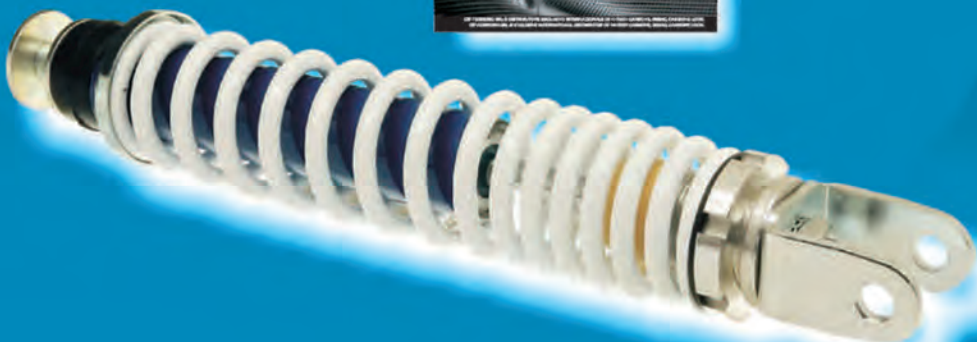

## SPECCHI RETROVISORI

REAR VIEW MIRRORS



OMOLOGATI / APPROVED

PIAGGIO / GILERA



Filetto M 8 x 1,25

ART. **2020-SX** SINISTRO NERO / BLACK LEFT  
(Sim. 271022)

ART. **2020-DX** DESTRO NERO / BLACK RIGHT  
(Sim. 271018)

### PIAGGIO

NRG 50 ('94-'96) - NRG RST MC2 50 (96-'98) - NTT 50 ('95-'96)

### GILERA

TYPHOON 50 ('94-'95) - TYPHOON X 50 ('98-'99)  
TYPHOON XR 50 ('00) - TYPHOON 125 ('95-'98)  
TYPHOON X - XR 125 (99-'00) - STORM 50 ('94-'95)



Filetto M 8 x 1,25

ART. **2021-SX** SINISTRO NERO / BLACK LEFT  
(Sim. 583031 ex 560968)

ART. **2021-DX** DESTRO NERO / BLACK RIGHT  
(Sim. 583033 ex 563096)

### PIAGGIO

LIBERTY 50 ('97-'05) - LIBERTY 4T 50 ('00-'02)  
LIBERTY 125 ('98-'00) - LIBERTY 125 - 150 ('01-'02)  
FREE CAT.



CALOTTA / BODY  
Ø 120 mm.

M10

M8

ART. **2021-SX** CROMATO SINISTRO  
CHROMED LEFT

ART. **2021-DX** CROMATO DESTRO  
CHROMED RIGHT

### PIAGGIO

LIBERTY 50 RST 4T - 125 - 150  
VESPA LX - GT SUPER





## SPECCHI RETROVISORI

REAR VIEW MIRRORS

OMOLOGATI / APPROVED

**PIAGGIO**



Filetto M 8 x 1,25

ART. **20212-SX** SINISTRO NERO / BLACK LEFT  
(Sim. 563866 ex 273852)

ART. **20212-DX** DESTRO NERO / BLACK RIGHT  
(Sim. 563865 ex 560583)

**PIAGGIO**  
VESPA ET2 50 ('97-'05) - VESPA ET2 INIEZIONE 50 ('97-'00)  
VESPA ET4 125 ('96-'98)



ART. **20213-SX** CROMATO SINISTRO  
CHROMED LEFT

ART. **20213-DX** CROMATO DESTRO  
CHROMED RIGHT

**PIAGGIO**  
BEVERLY 250

CALOTTA / BODY  
Ø 115 mm.



ART. **20255-SX** SINISTRO CROMATO  
CHROMED LEFT

ART. **20255-DX** DESTRO CROMATO  
CHROMED RIGHT

**UNIVERSALE VESPA**

## SPECCHI RETROVISORI REAR VIEW MIRRORS

E

OMOLOGATI / APPROVED

**PIAGGIO**

CALOTTA / BODY  
Ø 115 mm.



ART. **20253**

SINISTRO E DESTRO CROMATO  
CHROMED LEFT AND RIGHT



**UNIVERSALE VESPA**  
attacco alla scudo



ASTA REGOLABILE  
ADJUSTABLE ROD

CALOTTA / BODY  
Ø 115 mm.



300 mm.

Filetto M 10

ART. **20251**

SINISTRO / DESTRO CROMATO  
CHROMED LEFT / RIGHT

**UNIVERSALE VESPA**



ASTA REGOLABILE  
ADJUSTABLE ROD

Filetto M 10

ART. **20252**

SINISTRO / DESTRO CROMATO  
CALOTTA IN FERRO, CROMATURA 5 STRATI  
CHROMED LEFT / RIGHT  
IRON BODY, 5 COATS CHROMIUM PLATING

**UNIVERSALE VESPA**  
TUTTI I MODELLI





## SPECCHI RETROVISORI

REAR VIEW MIRRORS

OMOLOGATI / APPROVED

**PIAGGIO**

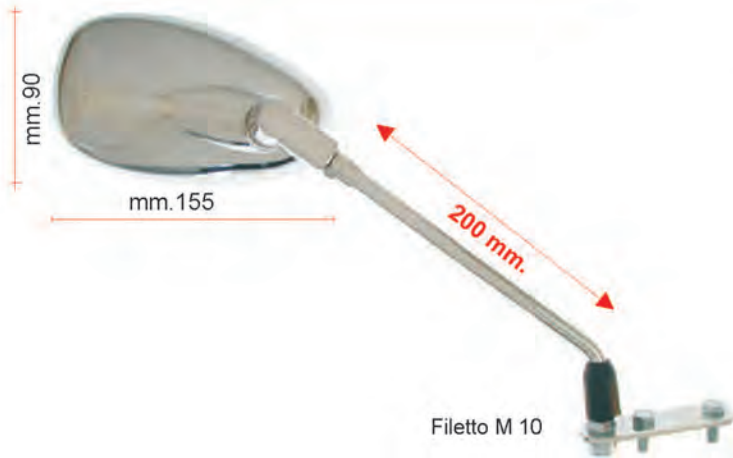

ART. **20254**

SINISTRO / DESTRO CROMATO  
CALOTTA IN FERRO, CROMATURA 5 STRATI

CHROMED LEFT / RIGHT  
IRON BODY, 5 COATS CHROMIUM PLATING

**UNIVERSALE VESPA  
TUTTI I MODELLI**



ART. **20256**

SINISTRO / DESTRO NERO  
BLACK LEFT / RIGHT

**UNIVERSALE VESPA**

CALOTTA IN PLASTICA Ø 124 mm.  
PLASTIC BODY Ø 124 mm.



ART. **20256-CARB**

SINISTRO / DESTRO NERO  
EFFETTO CARBONIO

BLACK LEFT / RIGHT  
LOOK CARBONIO

**UNIVERSALE VESPA**

## SPECCHI RETROVISORI

REAR VIEW MIRRORS



OMOLOGATI / APPROVED

APRILIA



Stelo Ø mm. 10

ART. **20222**

SINISTRO E DESTRO NERO  
BLACK LEFT AND RIGHT

APRILIA

RALLY LC - SCARABEO 50 DELUXE RX 50-125  
50 STREET DITECH



**ATTACCO A PINZA CON CAPPuccio IN GOMMA**  
**FILETTO M 8x1,25**  
**PINZER WITH RUBBER CAP**  
**THREAD M 8x1,25**

ART. **20221-SX**

PINZA SPECCHIO SINISTRO  
PINZER FOR LEFT MIRROR

ART. **20221-DX**

PINZA SPECCHIO DESTRO  
PINZER FOR RIGHT MIRROR



Stelo Ø mm.8

Filetto M 8 x 1,25

ART. **20223-SX**

SINISTRO NERO / BLACK LEFT  
(Sim. 8201585)

ART. **20223-DX**

DESTRO NERO / BLACK RIGHT  
(Sim. 8201798)

APRILIA

SCARABEO VECCHIO TIPO



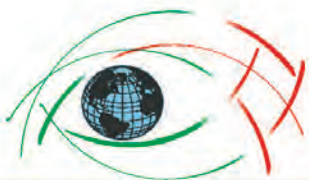

E

## SPECCHI RETROVISORI

REAR VIEW MIRRORS

OMOLOGATI / APPROVED

### MALAGUTI



ART. **20235-SX** SINISTRO NERO / BLACK LEFT  
(Sim. 08801303)

ART. **20235-DX** DESTRO NERO / BLACK RIGHT  
(Sim. 08801403)

**MALAGUTI**  
CENTRO - CROSSER - CIACK 50  
F10 - F12 - F15 FIRE FOX

### MBK



Filetto M 8 x 1,25

ART. **20240-SX** SINISTRO NERO / BLACK LEFT  
(Sim. 45BF 628000000)

ART. **20240-DX** DESTRO NERO / BLACK RIGHT  
(Sim. 45BF 629000000)

**MBK**  
BOOSTER NEXT GENERATION  
SPIRIT - TRACK - OVETTO

## BORDI SCUDO SHIELD BEADING

### VESPA LT - LX/LXV - S 2T/4T

LT 3V IE 4T 150 ('14) - LX 50 2T ('05-'13) - LX 50 4T ('05-'08)  
 LX 4T-4V 50 ('09-'13) - LX 2T TOURING 50 ('10-'13) - LX 125-150 ('05-'06)  
 LX EURO3 125-150 ('06-'08) - LX EU3 IE 125-150 ('09-'11)  
 LX 4T-4V TOURING 50 ('10-'13) - LX 4T 3V IE TOURING 125-150 ('12-'13)  
 LX 4T EU3 TOURING 125 ('10-'11) - LX TOURING 150 ('10-'12)  
 LX 4T FL 125-150 ('09) - LXV 50 2T ('06-'08) - LXV 50 2T NAVY ('08)  
 LXV 125 4T EU3 ('06-'08) - LXV 125 4T NAVY EU3 ('08)  
 LXV IE 4T 125 ('10-'13)  
 S 2T & COLLEGE 50 ('07-'12) - S 4T-4V 50 ('08-'09)  
 S 4T EU3 125 ('07-'08) - S 4T 3V IE 125 ('12)  
 S 4T & COLLEGE 125-150 ('09-'11) - S 4T 150 ('08-'09)

ART. **10177-SX** SINISTRO ARGENTO / SILVER LEFT (Sim.622187)  
 TIPO ORIGINALE / ORIGINAL MODEL

ART. **10177-DX** DESTRO ARGENTO / SILVER RIGHT (Sim.622188)  
 TIPO ORIGINALE / ORIGINAL MODEL

ART. **10177-SXN** SINISTRO NERO / BLACK LEFT  
 TIPO ORIGINALE / ORIGINAL MODEL

ART. **10177-DXN** DESTRO NERO / BLACK RIGHT  
 TIPO ORIGINALE / ORIGINAL MODEL



### VESPA ET2 / ET4

ET2 50 ('97-'05) - ET2 INIEZIONE 50 ('97-'00)  
 ET4 50 ('00-'05) - ET4 125 ('96-'98) - ET4 125-150 ('99-'02)

ART. **10174-SX** SINISTRO ARGENTO / SILVER LEFT (Sim.573002)  
 TIPO ORIGINALE / ORIGINAL MODEL

ART. **10174-DX** DESTRO ARGENTO / SILVER RIGHT (Sim.573001)  
 TIPO ORIGINALE / ORIGINAL MODEL







## BORDI SCUDO SHIELD BEADING

### VESPA GRANTURISMO-GT-GTS-GTV

VESPA GRANTURISMO 125 ('03-'07)  
GT EU3 125 ('06-'07) - GT 200 ('06-'07) - GT 60 EU3 250 ('06-'07)  
GTS EU3 125 ('07-'12) - GTS 250 ('05-'14) - GTS ABS 250 ('05-'12)  
GTS IE TOURING 300 ('11-'15) - GTS 4T IE SUPER 125 ('09-'15)  
GTS SUPER IE 4T 3V 150 ('14-'15) - GTS SUPER 300 ('08-'15)  
GTS SUPER SPORT 300 ('10-'13)  
GTV 125 ('06-'08) - GTV 250 ('06-'09) - GTV 4T NAVY EU3 125-250 ('08)  
GTV 4T 4V IE 300 ('10-'13) - GTV MONTENAPOLEONE 300 ('10)

ART. **10179-SX** SINISTRO ARGENTO / SILVER LEFT (Sim.577180)  
TIPO ORIGINALE / ORIGINAL MODEL

ART. **10179-DX** DESTRO ARGENTO / SILVER RIGHT (Sim.577181)  
TIPO ORIGINALE / ORIGINAL MODEL



### LIBERTY 2T/4T 50-125-150-200 cc.



ART. **7630-SX**  
DEFLETTORE SINISTRO  
PER SCUDO  
*LEFT PROTECTION FOR SHIELD*  
PIAGGIO  
LIBERTY 2T/4T 50/125/150/200  
TUTTI MODELLI / ALL MODELS  
(Sim. CM0200010043)



ART. **7630-DX**  
DEFLETTORE DESTRO  
PER SCUDO  
*RIGHT PROTECTION FOR SHIELD*  
PIAGGIO  
LIBERTY 2T/4T 50/125/150/200  
TUTTI MODELLI / ALL MODELS  
(Sim. CM0200020043)

## PIASTRINE BORDI SCUDO

### SHIELD BEADING PLATES



#### ART. 10379-SX

PIASTRINA SINISTRA PER BORDO SCUDO ESTREMITA' INFERIORE (Sim. 299964)  
LEFT PLATE FOR SHIELD BEADING LOWER END

VESPA ET2 50 ('97-'05) - ET2 INIEZIONE 50 ('97-'00)  
VESPA ET4 50('00-'05)-ET4 125 ('96-'02)  
VESPA LT 4T 3V IE 150 ('14) - LX 2T 50 ('05-'12) - LX 2T TOURING 50 ('10-'13)  
VESPA LX 4T 50 ('05-'08) - LX 4T 4V 50 ('09-'13) - LX 4T 4V TOURING 50 ('10-'13)  
VESPA LX 4T EU3 TOURING 125 ('10-'11)-LX TOURING 150 ('10-'12)-LX 125/150 ('05-'06)  
VESPA LX 4T FL 125/150 ('09) - LX EU3 125/150 ('06-'08)-LX EU3 IE 125/150 ('09-'11)  
VESPA LX 4T 3V IE 125/150 ('12) - LXV 2T 50 ('06-'08) - LXV 2T NAVY 50 ('08)  
VESPA LXV 4T NAVY EU3 125 ('08) - LXV 4T EU3 125 ('06-'09) - LXV IE 4T 125 ('10-'13)  
VESPA S 2T & COLLEGE 50 ('07-'12) - VESPA S 4T 4V & COLLEGE 50 ('08-'12)  
VESPA S 4T IE & COLLEGE 125/150 ('09-'11)-S 4T 3V IE 125 ('12)-S 4T EU3 125 ('07-'08)  
VESPA S 4T 150 ('08-'09)



#### ART. 10379-DX

PIASTRINA DESTRA PER BORDO SCUDO ESTREMITA' INFERIORE (Sim. 299965)  
RIGHT PLATE FOR SHIELD BEADING LOWER END

VESPA ET2 50 ('97-'05) - ET2 INIEZIONE 50 ('97-'00)  
VESPA ET4 50('00-'05)-ET4 125 ('96-'02)  
VESPA LT 4T 3V IE 150 ('14) - LX 2T 50 ('05-'12) - LX 2T TOURING 50 ('10-'13)  
VESPA LX 4T 50 ('05-'08) - LX 4T 4V 50 ('09-'13) - LX 4T 4V TOURING 50 ('10-'13)  
VESPA LX 4T EU3 TOURING 125 ('10-'11)-LX TOURING 150 ('10-'12)-LX 125/150 ('05-'06)  
VESPA LX 4T FL 125/150 ('09) - LX EU3 125/150 ('06-'08)-LX EU3 IE 125/150 ('09-'11)  
VESPA LX 4T 3V IE 125/150 ('12) - LXV 2T 50 ('06-'08) - LXV 2T NAVY 50 ('08)  
VESPA LXV 4T NAVY EU3 125 ('08) - LXV 4T EU3 125 ('06-'09) - LXV IE 4T 125 ('10-'13)  
VESPA S 2T & COLLEGE 50 ('07-'12) - VESPA S 4T 4V & COLLEGE 50 ('08-'12)  
VESPA S 4T IE & COLLEGE 125/150 ('09-'11)-S 4T 3V IE 125 ('12)-S 4T EU3 125 ('07-'08)  
VESPA S 4T 150 ('08-'09)



#### ART. 10375

PIASTRINA PER VITE AUTOFILETTANTE Ø mm.3,5 (Sim. CM017403)  
PLATE FOR SELF-TAPPING SCREW ø mm. 3,5

**PER FISSAGGIO BORDO SCUDO (ESTREMITA' INFERIORE)**  
PLATE FOR SELF-TAPPING SCREW DIAM.3,5 FOR TO FIX BOARD SHIELD LOWER END

VESPA LX - LX FL 2T/4T 50-125-150 - VESPA S 2T/4T 50-125-150

**APPLICAZIONI VARIE PER / GENERIC APPLICATIONS FOR:**  
BEVERLY - FLY - FREE - LIBERTY - NRG-SKIPPER - X9 - ZIP PORTER





## SCUDETTI EMBLEMS

mm.1



ART. **5776-R**

SCUDETTO RESINATO ADESIVO  
RESIN-TREATED EMBLEM ADHESIVE

**esagono/hexagon mm. 32**  
**bordo fine/ slim edge mm. 1**  
**grafia logo fine / slim writing logo**

(Sim. 295596)

SCOOTER PIAGGIO 50/80/125 cc.

FREE DELIVERY 50 ('00-'01) - FREE FL 50 ('95-'02)  
NRG 50 ('94-'96) - NTT 50 ('95-'96) - SFERA 125 ('95-'97)  
SKR CITY 80 ('99) - ZIP SP 50 ('96-'00)

ART. **5785-R**



SCUDETTO IN RILIEVO  
RESINATO AD INCASTRO

INTERLOCKING RESIN-TREATED  
EMBLEM IN RELIEF FOR HORNCAST

(Sim. 295486)

SCOOTER PIAGGIO 50/125/180/200/250/500 cc.

BEVERLY-FREE-HEXAGON-SUPER HEXAGON-LIBERTY  
QUARTZ-SFERA-SKIPPER-SKR CITY-VELOFAX - X8 - X9 - ZIP  
VESPA ET2 - ET4 - VESPA FL - FL2 - PK - PX - PXE ARCOBALENO

mm.2



ART. **5776-RN**

SCUDETTO RESINATO ADESIVO  
RESIN-TREATED EMBLEM ADHESIVE

**esagono/hexagon mm. 32**  
**bordo grosso / large edge mm. 2**  
**grafia logo grossa / large writing logo**

(Sim. 574771)

FLY 2T/4T 50 ('05-'07) - FLY 4T MOTORE CHN 50 ('06-'07)  
FLY 4T 100 ('06-'07) - FLY 125 / 150 ('05-'07) - FLY EU3 125 (2007)  
LIBERTY 4T PTT - DOUBLE - NEXIVE 50 ('09-'17)  
LIBERTY 4T IGET CORPORATE E4 50/125 ('18-'20)-125('98-'00)  
LIBERTY RST PTT 125 ('05-'11) - 4T 2V IE PTT-ITA 125('12-'13)  
LIBERTY 4T EU3 DELIVERY - TNT - NEXIVE 125 ('08-'15)  
MP3 300 LT BUSINESS SPORT ABS-ENJOY 300 ('14-'16)  
MP3 RL SPORT-BUSINESS 500 ('11-'12) - MP3 YOURBAN ERL 300 ('11-'15)  
X8 125 ('05-'06)-X8 200 ('05-'07)-EU3 250 ('05-'08)-STREET EU2 150 ('06-'08)  
X9 125('01-'02)-200('02-'03)-250('00-'01)-500 ('01-'02)-X9 AMALFI 180 ('00-'03)  
ZIP 4T 25KM-H 50 ('06-'16) - 50 ('00-'04) - 2T 50 ('08-'13) - 4T 50 ('00-'13)  
ZIP SP 50 ('01-'04) - SP EU2 50 ('06-'13)- 4T 100 ('06-'10) - 125 ('00-'02)  
CIAO EU1 50 ('99-'01) CIAO EU2 50 ('02-'04)

ART. **5788-P**



SCUDETTO AD INCASTRO  
INTERLOCKING EMBLEM

**esagono/hexagon mm. 42**

(Sim.1B003766-624554)

BEVERLY 250 ('06-'07)-EU3/ EU3 SPORT125 ('07-'08)-EU3 400 ('06-'07)  
EU3-MIC 125-250 ('07) - 125 ('04-'07) RST 4T 4V IE EU3 125/300 ('10-'15)  
SPORT 250 ('06-'07)-CRUISER 250 ('07-'09)  
BEVERLY TOURER EU3 125-250-300-400 ('08-'10)  
CARNABY 125-200 ('07-'10)-250 ('08)-CRUISER 300 ('09-'12)  
FLY 4T 2V 50 ('13-'15)-4T 4V 50 ('12-'13)-4T 3V IE EU3 DT 125 ('13-'15)  
LIBERTY 2T SPORT 50 ('06-'08)-4T 2V EU3 125 ('09-'12)  
4T 3V IE EU3 125 ('13-'14)-4T 3V-LEM 150 ('13-'14)- 4T SPORT 50 ('06-'08)  
4T SPORT EU3 125 ('06-'08)-4T-SPORT EU3 150 ('08)  
4T SPORT EU3 200 ('06-'07)-MOC 2T & ELLE 50 / MOC-4T EU3 150 ('09-'13)  
MP3 125/250 ('06-'08)-IE LT/IE MIC 300 SPORT ('10-'11)-MP3 LT BUSINESS-  
SPORT ABS-ENJOY 300 ('14-'15)-400 ('07-'08)-4T 4V IE IBRIDO 300('10-'13)  
MP3 IE LT TOURING 300 / LT SPORT BUSIN.500('11-'13)-TOURING 400 ('11)  
YOURBAN 125-300-X EVO 250-400 ('07-'13) -X7 EU3 125/250 ('08)  
X7 EVO IE EU3 125-300('09-'10)-X8 EU3 250 ('05-'08)-X8 EU3 400 ('06-'08)  
X8 PREMIUM EU2 125 ('06) - EU3-125 ('06-'07) - STREET EU2 125 ('06-'07)  
X10 4T 4V IE EU3 125/350 ('12-'13) - X10 4T 4V IE EU3 500 ('12-'14)



ART. **5782**

SCUDETTO  
RETTANGOLARE  
AD INCASTRO

INTERLOCKING  
RECTANGULAR EMBLEM

(Sim. 576464)

VESPA ET4 50 ('00-'05) - ET4 125-150 ('99-'02) - LX 125-150 ('05-'06)  
LX 2T/4T 125-150 ('05-'06) - LX EU3 125-150 ('06-'08) - LXV 2T 50 ('06-'08)  
LXV 2T NAVY 50 ('08) - LXV 4T EU3 125 ('06-'08)-4T NAVY EU3 125 ('08)  
GRANTURISMO 125 ('03-'07) - 200 ('06-'07) - EU3 125 ('06-'07)  
GT 60 EU3 250 ('06-'07)-GTS EU3 125 ('07-'08)-GTS SUPER 300 ('08)  
GTS ABS 250 ('05-'08) - GTV 125 ('07-'08) - 250 ('06-'07)-  
GTV 4T NAVY EU3 125-250 ('08) - PX 30 ANNI 125 ('07-'08)  
PX EU2 125 ('01-'07)-S 2T 50 ('07-'08) - 4T EU3 125('07-'08)  
APE CALESSINO 420 ('07-'08)



ART. **5787**

EMBLEMA GILERA PLASTICA  
CROMATA AD INCASTRO

INTERLOCKING CHROMED PLASTIC  
EMBLEM

(Sim. 573508)

RUNNER 50 ('97-'00)  
RUNNER POGGIALI 50 ('02)  
RUNNER PUREJET 50 ('02-'07)  
RUNNER SP 50 ('02-'07)  
RUNNER FX - FXR 125/180 ('97-'02)  
RUNNER VX 125 ('05-'06) - VX RACE 125 ('06)  
RUNNER VX SC 125 ('06-'07) - VX - VXR 125/180 ('00-'01)  
RUNNER VXR 200 ('05-'06) - VXR RACE 200 ('06)



## TARGHETTE NAMEPLATES

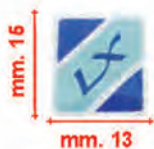

### ART. 10477

TARGHETTA "LX" **mm.13x15** ADESIVA RESINATA  
PER PARAFANGO ANTERIORE

(Sim.656026)

*FRONT MUDGUARD NAMEPLATE "LX" FOR (ADHESIVE RESIN)*

VESPA LX 2T 50 (09-13)- 4T-4V 50 (09-13 -LX 2T TOURING & 30KM 50 (10-13)  
VESPA LX 4T-4V TOURING 50 (10-13)-LX 4T FL 125/150 (2009)-LX EU3 IE 125/150 (09-11)  
VESPA LX 4T EU3 TOURING 125 (10-11) -4T 3V IE - TOURING 125/150 (12-13)  
VESPA LX TOURING 150 (10-12) - LT 4T 3V IE 150 (2014)

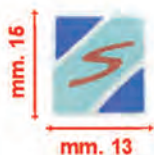

### ART. 10478

TARGHETTA "S" **mm.13x15** ADESIVA RESINATA  
PER PARAFANGO ANTERIORE

(Sim.654821)

*FRONT MUDGUARD NAMEPLATE "S" FOR (ADHESIVE RESIN)*

VESPA GTS 4T IE SUPER 125 (09-16) - GTS 4T 3V SUPER IE 150 (14-15)  
VESPA GTS SUPER 300 (08-16) - GTS SUPER SPORT 300 (10-13)  
VESPA S 2T & COLLEGE 50 (07-12) S 4T-4V & COLLEGE 50 (08-12)  
VESPA S 4T EU3 125 (07-08) - S 4T 3V IE 125 (2012)  
VESPA S 4T IE & COLLEGE 125 (09-11) e 150 (09-12) - S 4T 150 (08-09)



### ART. 10480

TARGHETTA "PIAGGIO" **mm. 68x13** ADESIVA RESINATA  
PER SCUDO ANTERIORE E PARAFANGO POSTERIORE

(Sim.620944)

*FRONT/REAR NAMEPLATE "PIAGGIO" (ADHESIVE RESIN)*

ZIP 2T 50 (08-13) - 4T 50 (00-13) - 4T 100 (06-10) - 4T 25KM-H 50 (06-16)  
TRACKMASTER 400 (2006) -PASSO CORTO 400 (06-08) - 500 (06-08)

## TARGHETTE RESINATE ADESIVE ADHESIVE RESIN NAMEPLATES







## TARGHETTE ADESIVE RESINATE

### ADHESIVE RESIN NAMEPLATES

#### ART. 10470

TARGHETTA FRONTALE PICCOLA (mm.98)  
ADESIVA RESINATA CROMATA

(Sim.656219 ex 577082)

*SMALL FRONT NAMEPLATE ADHESIVE RESIN CHROME*

ET2 50 ('97-'05)-ET2 INIEZIONE 50 ('97-'00)-ET4 50 ('00-'05)-ET4 125 ('96-'02)-ET4 150 ('99-'02)  
946 4T 3V ABS - 946 RED EMEA, APAC 125 (13-17)-ELETTRICA (18-19)-ELETTRICA 25KM/H  
(19)-ELETTRICA MOTOCICLO (19)-GRANTURISMO EU3 125 (06-07)-GT 60 EU3 250 (06-07)  
GTS-GTS SUPER IE ABS E4 (EMEA) 300 (16-18)-GTS 250 (05-14)-GTS 4T E4 ABS (EMEA) 150  
(16-17)-GTS 4T IE SUPER 125 (09-16)-GTS HPE 4T/4V IE ABS E4 300 (19)-GTS IE & TOURING  
300 (12-16)-GTS IE ABS E4 (EMEA) 125 (16-18)-GTS IE ABS E4 125 (19)-GTS IE ABS E4 ABS 4T  
SUPER 125 (18-19)-GTS SUPER 300 (08-16)-GTS SUPER HPE 4T/4V IE ABS 300 (18-19)-GTS  
SUPER IE 4T 3V AU,EX,JP,RI,T,V 150 (14-15)-GTV 125 (06-08)-GTV 250 (06-09)-GTV 4T NAVY  
EU3 125 (2008)-GTV 4T NAVY EU3 250(07)-GTV SEI GIORNI IE E4 ABS (EMEA) 300 (17-19)-GTV  
VIA MONTENAPOLEONE 300(2010)LT 4T 3VIE 150 (14)-LX 125/150 (05-06)-LX 2T 50 (05-08/09-  
13)-LX 2T TOURING & 30KM 50 (10-13)-LX 4T EU3 TOURING 125 (10-11)-LX 4T FL 125/150 ('09)  
LX 4T-4V TOURING 50 (10-13)-LX EU3 125 /150(06-08)-LX EU3 IE 125/150 (09-11)-LX  
PRIMAVERA 4T 3V IE 125 (13-17)-LX TOURING 150 (10-12)-LXV 2T 50 (06-09)-LXV 2T NAVY 50  
(2008)-LXV 4T EU3 125 (06-09)-LXV 4T NAVY EU3 125 (07-08)-LXV IE 4T 125 (10-13)  
PRIMAVERA 2T 50 (13-17)-PRIMAVERA 4T 2V 25 KM/H 50 (14-17)-PRIMAVERA 4T 3V 25 KM/H  
E4 50 (17-18) - PRIMAVERA 4T 3V E4 IGET ABS 125 (16-19)-PRIMAVERA 4T 3V IGET ABS  
(EMEA) 150 (16-19)-PRIMAVERA 4T-3V 150 (13-16)-PRIMAVERA 4T-3V NOABS E4 50 (17-18)  
PRIMAVERA 4T-4V NO ABS 50 (13-17)-PX 125-150-200('98-'01)-PX 30 ANNI 125('07-'08)  
X EU2 125 ('01-'07)-PX 125 / 150 (11-17)-S 2T & COLLEGE 50 (07-12) - S 4T 150 (08-09)-S 4T 3V  
IE 125 (2012) -S 4T EU3 125 (07-08)-S 4T IE & COLLEGE 125/150 (09-12)-S 4T-4V & COLLEGE  
50 (08-12)-SPRINT 2T NOABS E2 50 (14-17)-SPRINT 4T 2V 25 KM/H 50 (14-17)-SPRINT 4T 3V 25  
KM/H E4 50 (17-19)-SPRINT 4T 3V IE 125 (14-15) - SPRINT 4T 4V NOABS E2 EMEA 50 (14-17)  
SPRINT 4T-3V E4 50 (17-19)- SPRINT IGET 4T 3V ABS (EMEA) 125 (16-19)

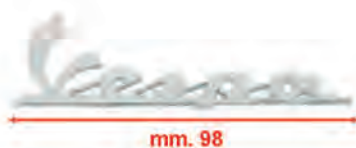

mm. 98

#### ART. 10470-BR

TARGHETTA FRONTALE PICCOLA (mm.98)  
ADESIVA RESINATA BRUNITA

(Sim. 672060)

*SMALL FRONT NAMEPLATE ADHESIVE RESIN BURNISHED*

GTS 4T IE SUPER 125 (09-16)-GTS SUPER 300 (08-16)-GTS SUPER SPORT 300 (10-13)  
S 4T-4V & COLLEGE 50 (08-12) - S 4T 3V IE 125 (2012)  
SPRINT 4T 3V IE 150 (2015) - SPRINT SPORT 4T 3V IGET ABS 150 (16-19)



mm. 98

#### ART. 10471

TARGHETTA LATERALE GRANDE (mm.150)  
ADESIVA RESINATA CROMATA

(Sim.656220 ex 577081)

*BIG LATERAL NAMEPLATE ADHESIVE RESIN CHROME*

ET2 50 ('97-'05)-ET2 INIEZIONE 50 ('97-'00)-ET4 50 ('00-'05)-ET4 125 ('96-'02) - ET4 150 ('99-'02)  
GRANTURISMO EU3 125 (06-07)-GT 60 EU3 250 (06-07)-GTS-GTS SUPER IE ABS E4 (EMEA)  
300 (16-18)-GTS 250 (05-14)-GTS 4T E4 ABS (EMEA) 150 (16-17)-GTS 4T IE SUPER 125 (09-16)  
GTS HPE 4T/4V IE ABS E4 300 ('19)-GTS IE ABS E4 (EMEA) 125 (16-18)-GTS IE ABS E4 125  
(19)-GTS IE ABS E4 ABS 4T SUPER 125 (18-19)-GTS SUPER 300 (08-16)-GTS SUPER HPE  
4T/4V IE ABS 300 (18-19)-GTS SUPER IE 4T 3V 150 (14-15)-GTV 125 (06-08)-GTV 250 (06-09)  
GTV 4T NAVY EU3 125 ('08)-GTV 4T NAVY EU3 250 ('07)-GTV SEI GIORNI IE E4 ABS (EMEA)  
300 (17-19)-GTV VIA MONTENAPOLEONE 300 ('10)-LT 4T 3V IE 150 (2014)-LX 125/150 (05-06)  
LX 2T 50 (05-08)-LX 2T TOURING & 30KM 50 (10-13)-LX 4T EU3 TOURING 125 (10-11)-LX 4T FL  
125/150 ('09)-LX 4T-4V 50 (09-13)-LX 4T-4V TOURING 50 (10-13)-LX EU3 125/150(06-08)-LX EU3  
IE 125/150 (09-11)-LX TOURING 150 (10-12)-LXV 2T 50 (06-09)-LXV 2T NAVY 50 ('08)-LXV 4T  
EU3 125 (06-09)-LXV4T NAVY EU3 125 (07-08)-IE 4T 125 (10-13)-PX 125-150-200 ('98-'01)  
PX 30 ANNI 125 ('07-'08)-PX EU2 125 ('01-'07)-PX 125 (11-17)-S 2T & COLLEGE 50 (07-12)-S 4T  
4V & COLLEGE 50 (08-12)-S 4T EU3 125(07-08)-S4T IE & COLLEGE 125(09-11)-S4T 150(08-09)



mm. 150

#### ART. 10471-BR

TARGHETTA LATERALE GRANDE (mm.150)  
ADESIVA RESINATA BRUNITA

(Sim.672061)

*BIG LATERAL NAMEPLATE ADHESIVE RESIN BURNISHED*

GTS 4T IE SUPER 125 (09-16)- GTS SUPER 300 (08-16)-GTS SUPER SPORT 300 (10-13)  
S 2T & COLLEGE 50 (07-12)-S 4T-4V & COLLEGE 50 (08-12)-S 4T 3V IE 125 (12)  
SPRINT 2T NO ABS E2 50 (14-17)-SPRINT 4T 2V 25 KM/H 50(14-17)-4T 3V IE 125 (14-15)  
SPRINT 4T 3V IE 150 (15)-SPRINT SPORT 4T 3V IGET ABS 150 (16-19)



mm. 150



## TARGHETTE RESINATE ADESIVE

### ADHESIVE RESIN NAMEPLATES



#### ART. 10472

TARGHETTA ADESIVA RESINATA CROMATA

(Sim. 656221)

ADHESIVE RESIN CHROME NAMEPLATE

VESPA LX 2T 50 ('09-'13) - LX 2T TOURING 50 (10-'13)  
VESPA LX 4T 50 ('05-'08) - LX 4T-4V TOURING 50 ('10-'13)



#### ART. 10467

TARGHETTA "SPRINT" PICCOLA (mm.60)  
RESINATA ADESIVA CROMATA X SCUDO ANTERIORE

(Sim.1B001263)

FRONT NAMEPLATE, SMALL mm.60 (ADHESIVE RESIN CHROME)

VESPA SPRINT 4T 2V 25 KM/H 50 (14-17) - 4T 3V 25 KM/H E4 50 (17-20)  
SPRINT 2T NO ABS E2 50 (14-17) - 4T 4V NOABS E2 EMEA 50 (14-17)  
SPRINT 4T-3V E4 50 (17-20) - 4T 3V IE 125 (14-15) - IGET 4T 3V ABS (EMEA) 125 (16-20)



#### ART. 10467-BR

TARGHETTA "SPRINT" PICCOLA (mm.60)  
ADESIVA BRUNITA X SCUDO ANTERIORE

(Sim.2H000928)

FRONT NAMEPLATE, SMALL mm.60 (ADHESIVE BURNISHED)

VESPA SPRINT 2T NO ABS E2 50 (14-17) - 4T 2V 25 KM/H 50 (14-17)  
SPRINT 4T 3V IE 125 (14-15) - 4T 3V IE 150 (2015) - SPORT 4T 3V IGET ABS 150 (16-19)



#### ART. 10468

TARGHETTA "SPRINT" GRANDE (mm.115)  
RESINATA ADESIVA CROMATA LATERALE

(Sim.1B000943)

LATERAL NAMEPLATE, BIG TYPE mm.115 (ADHESIVE RESIN CHROME)

VESPA SPRINT 4T 2V 25 KM/H 50 (14-17) - 4T 3V 25 KM/H E4 50 (17-20)  
25 KM/H E5 50 (2020) - 2T NO ABS E2 50 (14-17) 4T 4V NO ABS E2 EMEA 50 (14-17)  
4T 3V E5 50(2020)-4T-3V E4 50(17-20)-4T 3V IE 125(14-15)-4T 3V ie ABS E5 125(20-21)  
IGET 4T 3V ABS (EMEA) 125 (16-20)-RACING SIXTIES ABS E5 150 (2021)  
SPORT 4T 3V IGET ABS 150 (16-19) - SPORT ABS E5 150 (2020)



#### ART. 10468-BR

TARGHETTA "SPRINT" GRANDE (mm.115)  
ADESIVA BRUNITA LATERALE

(Sim.2H000927)

LATERAL NAMEPLATE, BIG TYPE mm.115 (ADHESIVE BURNISHED)

VESPA SPRINT 2T NO ABS E2 50 (14-17) - 4T 2V 25 KM/H 50 (14-17)-4T 3V IE 125 (14-15)  
SPRINT 4T 3V IE 150 (2015) - SPORT 4T 3V IGET ABS 150 (16-19)



#### ART. 10462

TARGHETTA LATERALE "PRIMAVERA" (mm.153)  
RESINATA ADESIVA CROMATA

(Sim.1B000942)

LATERAL NAMEPLATE, (ADHESIVE RESIN CHROME)

VESPA PRIMAVERA 4T 2V 25 KM/H 50 (14-17) - 4T 3V 25 KM/H E4 50 (17-19)  
PRIMAVERA 25 KM/H E5 50 (20-21) - 2T 50 (13-17) - 4T 3V E5 50 (20-21)  
PRIMAVERA 4T-3V NO ABS E4 50 (17-20) - 4T-4V NO ABS 50 (13-17)  
LX PRIMAVERA 4T 3V IE 125 (13-17) - 4T 3V E4 IGET ABS 125 (16-20)  
PRIMAVERA 4T 3V IE ABS E5 125 (20-21)  
PRIMAVERA 150 E5 150 (20-21) - 4T-3V 150 (13-16)  
PRIMAVERA 4T 3V IGET ABS (EMEA) 150 (16-20)





## PARAFANGHI ANTERIORI FRONT MUDGUARDS



ART. **7640**

PARAFANGO ANTERIORE IN PLASTICA  
*FRONT PLASTIC MUDGUARD*

VESPA ET2 - ET4  
(Sim. 8249005 ex 4270005)



ART. **7642**

PARASPRUZZO POSTERIORE IN PLASTICA  
*REAR PLASTIC FLAP*

VESPA ET2 - ET4



ART. **7652**

PARAFANGO ANTERIORE IN PLASTICA  
*FRONT PLASTIC MUDGUARD*

VESPA LX 50-125-150 - LXV 50-125  
(Sim. 666528)



ART. **7654**

PARAFANGO ANTERIORE IN PLASTICA  
*FRONT PLASTIC MUDGUARD*

VESPA GTS 125-150-250-300  
(Sim. 651029)



ART. **7646**

PARAFANGO ANTERIORE IN PLASTICA  
*FRONT PLASTIC MUDGUARD*

PIAGGIO NRG - NTT

## PARAFANGHI ANTERIORI FRONT MUDGUARDS



ART. **7648**

PARAFANGO ANTERIORE IN PLASTICA  
FRONT PLASTIC MUDGUARD

PIAGGIO LIBERTY FINO AL/TILL TO 2004

**RUOTA 16" STRETTA**  
**WHEEL 16" SLIM**

(Sim. 5749525 ex 817000)



ART. **7649**

PARAFANGO ANTERIORE IN PLASTICA  
FRONT PLASTIC MUDGUARD

PIAGGIO LIBERTY  
DAL 2004 AL 2008

**RUOTA 16" LARGA**  
**WHEEL 16" LARGE**



ART. **7650**

PARAFANGO ANTERIORE IN PLASTICA  
FRONT PLASTIC MUDGUARD

**RUOTA 16" LARGA**  
**WHEEL 16" LARGE**

PIAGGIO LIBERTY MOC

(Sim. 655753-667180)



ART. **7658**

PARAFANGO ANTERIORE IN PLASTICA  
FRONT PLASTIC MUDGUARD

PIAGGIO BEVERLY 125 - 300 - 350  
DAL 2010

(Sim. 667197)





## PARAFANGHI ANTERIORI FRONT MUDGUARDS



ART. **7660**

PARAFANGO ANTERIORE IN PLASTICA  
FRONT PLASTIC MUDGUARD

HONDA SH 125-150 ('01-'04)

MONTABILE SU TUTTI SH DAL 2005 AL 2012  
MOUNTABLE ON ALL SH FROM 2005 TO 2012



ART. **7661**

PARAFANGO ANTERIORE IN PLASTICA  
FRONT PLASTIC MUDGUARD

HONDA SH 125-150 DAL/FROM 2013



ART. **7663**

TERMINALE MARMITTA NON VERNICATO  
IN MATERIALE TERMORESISTENTE

MUFFLER TERMINAL, NOT PAINTED  
THERMO RESISTANT MATERIAL

HONDA SH 300 (2007-2013) - FORZA 300 (2013)

ART. **7665**

PROTEZIONE MARMITTA NON VERNICIATA  
IN MATERIALE TERMORESISTENTE

MUFFLER PROTECTION, NOT PAINTED  
THERMO RESISTANT MATERIAL

HONDA SH 300 (2007-2013) - FORZA 300 (2013)

## COPERCHI MANUBRIO

HANDLEBAR COVERS



ART. **8151**

COPERCHIO MANUBRIO

VESPA ET2 - ET4  
LIBERTY 50 ('97-'05)  
LIBERTY125 ('98-'02)

(Sim. 4272005)



ART. **8152**

COPERCHIO MANUBRIO

VESPA LX 2T 50 ('05-'13)  
VESPA LX 2T TOURING 50 ('10-'13)  
VESPA LX 4T 50 ('05-'09)  
VESPA LX 4T-4V 50 ('09-'13)  
VESPA LX 4T-4V TOURING 50 ('10-'13)  
VESPA LX 125/150 ('05-'06)  
VESPA LX EU3 125/150 ('06-'08)  
VESPA LX EU3 IE 125/150 ('09-'11)  
VESPA LX 4T FL 125/150 ('09)  
VESPA LX 4T 3V IE TOURING 125/150 ('12-'13)  
VESPA LX 4T EU3 TOURING 125 ('10-'11)  
VESPA LX TOURING 150 ('10-'12)  
VESPA LX 4T 3V IE 150 ('14)

(Sim. 652935)



ART. **8155**

COPERCHIO MANUBRIO

COLORE NERO / BLACK COLOUR

VESPA GTS 300 ('14->)

ADATTABILE A / SUITABLE TO:  
VESPA GTS ABS 250 ('05-'12) TELAIO/FRAME 45101  
VESPA GRANTURISMO 125 ('06-'07) TELAIO/FRAME M31101

(Sim.1B001185)



ART. **10445**

VISIERA TRASPARENTE

TRANSPARENT VISOR

PIAGGIO  
QUARTZ 50 ('92-'96)  
SKIPPER 125 e 150 ('94-'97)  
SKR CITY 80 cc. ('99)

(SIM 562416 - 267861)





## MASCHERINE COPRISTERZO FRONT STEERING COVERS



ART. **7681**

MASCHERINA COPRISTERZO / FRONT STEERING COVER

LIBERTY 50 ('97-'05) - LIBERTY- 4T 50 ('01-'02)  
LIBERTY 125 ('98-'02)

(Sim. 5761785)



ART. **5785-R**

SCUDETTO / EMBLEM



ART. **7680**

MASCHERINA COPRISTERZO / FRONT STEERING COVER

VESPA ET2 50 ('97-'05) - VESPA ET2 INIEZIONE 50 ('97-'00)  
VESPA ET4 50 ('00-'05) - VESPA ET4 125 ('96-'02)

(Sim. 4722005)



ART. **5785-R**

SCUDETTO PER VEICOLI FINO AL '99  
EMBLEM VEHICLES TILL TO '99



ART. **5782**

SCUDETTO PER VEICOLI DAL 2000  
EMBLEM VEHICLES FROM 2000->



ART. **7683**

MASCHERINA COPRISTERZO / FRONT STEERING COVER

VESPA GTS 125-250-300 - VESPA GTV 125-250  
VESPA GT 60 EU3 250

(Sim. 621143)



ART. **5782**

SCUDETTO PER VEICOLI DAL 2000  
EMBLEM VEHICLES FROM 2000->



ART. **7682**

MASCHERINA COPRISTERZO / FRONT STEERING COVER

VESPA LX 2T TOURING & 30 KM.50 ('10-'13)  
LX 4T EU3 TOURING 125 ('10-'11)  
LX TOURING 150 ('10-'12)

(Sim. 6575885)



ART. **5782**

SCUDETTO PER VEICOLI DAL 2000  
EMBLEM VEHICLES FROM 2000->



## SERIE CALOTTE STERZO

### BEARING BALL TRACK

Made in Italy

**PIAGGIO:** BEVERLY - CARNABY 125/200 - FLY 2T 50 - FLY 4T 50 - FREE 100 - HEXAGON - LIBERTY 50/125/200-MYMOOVER DELIVERY 4T 4V E5 125(21) LIBERTY MYMOOVER POSTE ITALIANE 125 (2021)-PIAGGIO 1 MOPED (2021)-PIAGGIO 1 MOTORCYCLE (2021)-MP3-NRG 50-NTT 50-QUARTZ 50-SFERA 50/125 SFERA MAQUILLAGE 2-SKIPPER-SKR CITY-SUPER HEXAGON-X EVO 125/250/400-X10 4T 4V IE EU3 500 (12-14)-ZIP 50-ZIP 125-VESPA ET2 50-ET2 INIEZIONE 50 Et4 50/125-VESPA 946 4T 3V ABS-946 RED EMEA, APAC 125 (13-19)-946 4T 3V ABS ARMANI 125 (2015)-946 CD E5 ABS 125 (2021)-VESPA ELETTRICA (18-19) ELETTRICA 25KM/H (2019)-ELETTRICA MOTOCICLO (2019)-ELETTRICA MOTOCICLO 70KM/H (19-20)-GRANTURISMO 125 (03-07)-GRANTURISMO EU3 125(06-07) GTS ABS 250(05-12)-GTS-GTS SUPER IE ABS E4 (EMEA) 300(16-18)-GTS 4T E4 ABS(EMEA)150(16-18)-GTS 4T IE SUPER 125 (09-16)-GTS EU3 125 (07-12) GTS HPE 4T/4V IE ABS E4 300 (2019)-GTS IE & TOURING 300 (12-16)-GTS IE ABS E4 (EMEA) 125 (16-18)-GTS IE ABS E4 125 ('19)-GTS IE ABS E4 ABS 4T SUPER 125 (18-20)-GTS IE TOURING 300 (11-12) - GTS SUPER 300 (08-16)-GTS SUPER HPE-TECH 4T/4V IE ABS 300 (18-20) - GTV 125 (06-08) - GTV 250 (06-09) - GTV 4T NAVY EU3 125(2008)-GTV 4T NAVY EU3 250(2007)-GTV SEI GIORNI IE E4 ABS(EMEA)300(2017)-GTV VIA MONTENAPOLEONE 300(2010)-LT 4T 3V IE 150 (2014) LX 125/150 (05-06)-LX 2T 50 (2005-2013)-LX 2T TOURING & 30KM 50 (10-13)-LX 4T 3V IE-TOURING 125/150 (12-13)-LX 4T EU3 TOURING 125 (10-11)-LX 4T FL 125/150 (2009)-LX 4T-4V TOURING 50 (10-13)-LX EU 3 125 (06-08)-LX EU 3 150 (06-08)-LX EU 3 IE 125/150 (09-11)-LX PRIMAVERA 4T 3V IE 125 (13-17)-LXV 2T 50 (06-09)-LXV 2T NAVY 50 (2008)-LXV 4T EU3 125 (06-09)-LXV 4T NAVY EU3 125 (07-08)-LXV IE 4T 125 (10-13)-VESPA PRIMAVERA 2T 50 (13-17) - PRIMAVERA 4T 2V 25 KM/H 50 (14-17)-PRIM.4T 3V 25 KM/H E4 50(17-19)-PRIM.4T 3V E4 IGET ABS 125(16-20)-PRIM.4T-3V 150 (13-16)-PRIM. 4T-3V NOABS E4 50 (17-20) PRIMAVERA 4T-4V NO ABS 50(13-17)-VESPA S 2T & COLLEGE 50(07-12)-S 4T 150(08-09)-S 4T 3V IE 125 (2012)-S 4T EU3 125(07-08)-S 4T IE & COLLEGE 125/150 (09-11)-S 4T-4V & COLLEGE 50 (08-12)-SPRINT 2T NOABS E2 50 (14-17)-SPRINT 4T 2V 25 KM/H 50 (14-17)-SPRINT 4T 3V 25 KM/H E4 50 (17-20) - SPRINT 4T 3V IE 125/150 (14-15)-SPRINT 4T 4V NOABS E2 EMEA 50 (14-17)-SPRINT 4T-3V E4 50 (17-20)-SPRINT SPORT 4T 3V IGET ABS 150 (16-19)-VESPA SXL 4T 3V CARB 150 (2019) - VESPA 50-125 (67-82)-125 (55-65)-FL 50 (90)-FL 125 (89-90)-FL2 AUTOMATICA 50 (90-91)-FL2 HP 50 (91-97) GS-SUPER SPORT 150 (55-65)-N 50 (89-90)-PK 50 (82-84)-PK AUTOM.50(84-89)-PK XL 50(85-88)-PK XL 125(86-89)-PK XL PLURIMATIC 50(85-90)-RUSH 50(88-89)-PX 125(98-01)-PX E 150 (98-05) PX EU2 125(01-07)-PXE ARCOB.125(81-97)-PX 125/150 (11-17)-SPRINT-GR-SUPER-RALLY (65-76)-T5 125 (85-89)-COSA 2 125 (91) - COSA CL-CLX 125 (88-91)

**GILERA:** EASY MOVING-GP CENTENARIO 800(2009)-ICE 50-NEXUS EU3 125/250-RUNNER-STALKER-STORM EU2 50-TYPHOON 50-2T EU2 50-4T 2V EU3 125

**APRILIA:** SCARABEO LIGHT 300 (09-10)-LIGHT 400/500 (06-08)-SPORT CITY ONE 2T 50 (08-11)-SPORT CITY ONE 4T 50 (08-10)-SPORT CITY ONE 4T EU3 125 (08-11) - SR MOTARD 125 (12-14) - SR MOTARD 2T 50 (12-14) - SR MOTARD 4T 4V 50 (13-19)

### HIGH QUALITY



#### ART. 5611-SHQ

SR.CALOTTE STERZO **SUPERIORE**  
COMPLETA DI GHIERA FILETTATA E GABBIA  
(Nr. 5 pz.)

"HIGH QUALITY" MADE IN ITALY

COMPLETE **UPPER**  
BEARING BALL TRACK (No. 5 pcs.)  
WITH CAGE AND THREADED RING AND CAGE

(SIM.65069345 - 56002R - 153025)



### HIGH QUALITY



#### ART. 5611-IHQ

SR.CALOTTE STERZO **INFERIORE**  
COMPLETA DI GHIERA  
(Nr. 4 pz.)

"HIGH QUALITY" MADE IN ITALY

COMPLETE **LOWER**  
BEARING BALL TRACK (Nr. 4 pcs.)

(SIM. 650075-56003R)







## SERIE CALOTTE STERZO

BEARING BALL TRACK

Made in Italy



ART. **5611-S**

SERIE CALOTTA STERZO **SUPERIORE**  
COMPLETA DI GABBIA (Nr. 3 pz.) MADE IN ITALY

**UPPER BEARING BALL TRACK**  
COMPLETE WITH CAGE (No. 3 pcs.) MADE IN ITALY

(Sim.65069345 - 56002R - 153025)



ART. **5611-I**

SERIE CALOTTA STERZO **INFERIORE**  
COMPLETA DI GABBIA (Nr. 2 pz.) MADE IN ITALY

**LOWER BEARING BALL TRACK**  
COMPLETE WITH CAGE (Nr. 2 pcs.) MADE IN ITALY

(Sim. 650075-56003R)

**HIGH QUALITY**



ART. **10390**

GHIERA FILETTATA BLOCCAGGIO (Sim. 0111094)  
PER SERIE STERZO **SUPERIORE**

THREADED RING SEC. **UPPER BEARING BALL TRACK**

APPLICAZIONE ANCHE SU: APE MIX 50 2T(98-08)-APE 50 2T EU4 (18-20)

ART. **6600**

RONDELLA **SUPERIORE** PER SERIE STERZO  
**UPPER WASHER FOR BEARING BALL TRACK**

Ø INTERNO / INTERNAL mm.30,2 x 40 x 2,5

(Sim 003751)



ART. **5615**

GABBIA (mm. 31,4 x 39,6 x 2,6)  
PER SERIE STERZO **SUPERIORE**  
CAGE FOR  
**UPPER BEARING BALL TRACK**

**HIGH QUALITY**



ART. **6601**

RONDELLA PARAPOLVERE  
PER SR. STERZO **INFERIORE**  
**DUST WASHER FOR**  
**LOWER BEARING BALL TRACK**

Ø INTERNO / INTERNAL mm.34,5  
Ø ESTERNO / EXTERNAL mm.63



ART. **5616**

GABBIA (mm. 43 x 53 x 6,5)  
PER SERIE STERZO **INFERIORE**  
CAGE FOR **LOWER**  
BEARING BALL TRACK

**HIGH QUALITY**



ART. **5617-A**

GABBIETTA X SR. STERZO  
(CON SFERE 3/16)  
CAGE FOR BEARING BALL TRACK  
(WITH BALLS 3/16)

(Sim. 122644)

PIAGGIO FREE 50 ('92-'94) - FREE FL 50 ('95-'00)  
FREE DELIVERY 50 ('00-'01) - MP3 125/250 ('06-'08)  
SCATTO 50 ('92-'93) - ZIP

CICLOMOTORI/MOPEDS PIAGGIO  
SI' 50 ('79-'88) - SI' FL2 50 ('91-'97)  
SI' MIX 50 ('96-'99) - BRAVO'82 - BRAVO 3 50 ('87-'99)  
BRAVO ERRE 2 50 ('75-'81) SUPERBRAVO 50 ('85-'90)

**HIGH QUALITY**



ART. **5968**

PARAOILIO CORTECO 25.7x35x7/9  
PER FORCELLA  
FORK OIL SEAL

(Sim. 269888)

PIAGGIO ZIP 50 ('92-'93)-ZIP BIMODALE 50('94-'97)  
ZIP FAST RAIDER 50('93-'94)-ZIP Freno a Disco  
GILERA EASY MOVING 50 ('95-'96)

CICLOMOTORI/MOPEDS PIAGGIO  
SI' 50 ('79-'88) - SI' FL2 50 ('91-'97) - SI' MIX 50 ('96-'99)  
BRAVO'82 - BRAVO 3 50 ('87-'99) - BRAVO ERRE 2 50 ('75-'81)  
SUPERBRAVO 50 ('85-'90) - SUPERBRAVO 3 50 ('87-'90)





## ASSI RUOTA ANTERIORE FRONT WHEEL AXLES



ART. **3259**

ASSE RUOTA ANTERIORE COMPLETO SCATOLATO  
(mm. 11 x 165)

(Completo di dadi alti - bassi - coni - rondelle e gabbie)  
(Complete with high nuts-low nuts-cones-washers-cages)

PIAGGIO FREE - PIAGGIO SI' E CICLOMOTORI



ART. **3263**

ASSE RUOTA ANTERIORE COMPLETO SCATOLATO  
(mm. 11 x 200)

(Completo di dadi alti - bassi - coni - rondelle e gabbie)  
(Complete with high nuts-low nuts-cones-washers-cages)

PIAGGIO ZIP - CICLOMOTORI



ART. **3266**

GABBIETTA IN NYLON PER CALOTTA  
Ø mm. 32 CON SFERE DA 1/4  
NYLON CAGE, FOR HUB CAP - Ø mm. 32  
WITH BALLS 1/4

SCOOTER - CICLOMOTORI



ART. **C00105**

DADO ALTO Ø mm. 11 PER ASSE RUOTA  
HIGH NUT FOR FRONT WHEEL AXLE

SCOOTER - CICLOMOTORI (Sim.114415)



ART. **3267**

CONO Ø mm. 11 PER ASSE RUOTA  
CONE Ø mm. 11 FOR WHEEL AXLE

SCOOTER - CICLOMOTORI (Sim. 114411)



ART. **C00106**

DADO BASSO mm. 11 PER ASSE RUOTA  
LOW NUT FOR FRONT WHEEL AXLE

SCOOTER - CICLOMOTORI (Sim.135697)



ART. **5620**

SFERE DA 1/4 Ø mm.6,3  
PER CALOTTINA MOZZO RUOTA  
BALLS 1/4" ø mm. 6,3 FOR WHEEL PIN CUP

SCOOTER - CICLOMOTORI



CALOTTE PER MOZZO / HUB CAPS

ART. **3098** ARRESTO / STOP mm. 32

ART. **3100** ARRESTO / STOP mm. 35

SCOOTER - CICLOMOTORI

# M12



ART. **C00113**

ASSE RUOTA ANTERIORE (M12 x 200)  
FRONT WHEEL AXLE

CICLOMOTORI VARI



ART. **C00110**

DADO ALTO M12 PER ASSE RUOTA  
HIGH NUT FOR FRONT WHEEL AXLE

CICLOMOTORI





# CUSCINETTI ASSI RUOTA 2RSH

## WHEEL AXLE BEARINGS

### DUE LATI SCHERMATI

### TWO SCREENED SIDES



CIF ART.	DESCRIZIONE / DESCRIPTION	APPLICAZIONI / APPLICATIONS
<b>16201</b>	CUSCINETTO <b>12x32x10</b> 2 LATI SCHERMATI ASSE RUOTA ANTERIORE <i>2 SIDES SCREENED FRONT WHEEL AXLE</i>	SKF 6201 2RSH MALAGUTI F12 50 e 100 cc. ('94-'99) - F15 ('96-'99) CENTRO ('94-'99) - CIAK - CROSSER MBK FLIPPER ('98-'99) - SKYLINER 125 FLAME ('98-'99) - VERTEX 150 YAMAHA WHY 50 - MAJESTY 125 FLYONE 150 - CYGNUS/BELUGA 125 HONDA SH 50 - SKY - VISION - WALLARO
<b>16206</b>	CUSCINETTO <b>10x35x11</b> 2 LATI SCHERMATI ASSE RUOTA ANTERIORE <i>2 SIDES SCREENED FRONT WHEEL AXLE</i>	SKF 6300 2RSH MBK BOOSTER 50 ('90-'94) - NG ('95-'99) SPIRIT ('96-'99) - TRACK - ROCKET OVETTO - NITRO 50 - EVOLIS - FIZZ FORTE YAMAHA AXIS 50 - AEROX - NEOS - BREEZE BW'S BUMP
<b>16207</b>	CUSCINETTO <b>10x30x9</b> 2 LATI SCHERMATI ASSE RUOTA ANTERIORE <i>2 SIDES SCREENED FRONT WHEEL AXLE</i>	SKF 6200 2RSH (Sim.007035) MALAGUTI F10 ('92-'99) YESTERDAY ('97-'99)
<b>16209</b>	CUSCINETTO <b>15x35x11</b> 2 LATI SCHERMATI ASSE RUOTA ANTERIORE-TAMBURO ANTERIORE <i>2 SIDES SCREENED FRONT WHEEL AXLE - FRONT BRAKE DRUM</i>	SKF 6202 2RSH PIAGGIO VESPA ET2 - ET4 SFERA RST 50 QUARTZ 50 - ZIP SP 50 SFERA 125 SKIPPER 125-150 HEXAGON tutti mod.
<b>16210</b>	CUSCINETTO <b>17x40x12</b> 2 LATI SCHERMATI ASSE RUOTA POSTERIORE <i>2 SIDES SCREENED - REAR WHEEL AXLE</i>	SKF 6203 2RSH MOTORI 50 cc. MINARELLI - YAMAHA - MBK PIAGGIO FREE - NRG-QUARTZ-SFERA-ZIP
<b>16204-2RS</b>	CUSCINETTO <b>20x47x14</b> 2 LATI SCHERMATI ASSE RUOTA POSTERIORE <i>2 SIDES SCREENED - REAR WHEEL AXLE</i>	SKF 6204-2RSH PIAGGIO SCOOTER E VESPA TUTTI TIPI
<b>16303-2RS</b>	CUSCINETTO <b>17x47x14</b> 2 LATI SCHERMATI ASSE RUOTA POSTERIORE AMMORTIZZATORE ANTERIORE/POSTERIORE <i>2 SIDES SCREENED REAR WHEEL AXLE FRONT/REAR SHOCK ABSORBERS</i>	SKF 6303 2RSH RUOTA POST: BEVERLY - HEXAGON GTX 125-180 SFERA 125-SKIPPER 125 VESPA GT 125-200 ('03-'05) X9 250 ('00-'01) AMM.POST: BEVERLY-CARNABY-MP3 VESPA GTS - GTS SUPER X EVO - X9 .... AMM.ANT.: MP3 LT 250/400 - MP3 MIC 250/400

**APRILIA**

SCARABEO 50 ('03) ('05)  
SCARABEO 50 4T ('05)  
SCARABEO 100 ('00-'04)  
SCARABEO 100 4T ('05)  
SCARABEO FRENO A DISCO



ART. **10393**  
LEVETTA ALZAVOLVOLA  
VALVE LIFTER LEVER

**PIAGGIO / GILERA**

PIAGGIO ZIP - FREE  
GILERA TYPHOON-STORM



ART. **10254-S**  
PORTALEVA SX (FORO PASSANTE)  
CONTROL HOLDER LEVER, LEFT (THROUGH HOLE)



ART. **10254-D**  
GAS - PORTALEVA DX  
THROTTLE CONTROL  
HOLDER LEVER, RIGHT

**PIAGGIO**

LIBERTY 50  
VESPA ET2 50 ('97->) - VESPA ET4 ('96->)



ART. **10361**  
PORTALEVA SX (Sim. 564641)  
LEFT CONTROL HOLDER LEVER



ART. **10361-S**  
LEVA SX CROMATA  
CHROMED LEFT LEVER



ART. **10361-D**  
LEVA DX CROMATA  
CHROMED RIGHT LEVER





## PORTALEVE - LEVE

### CONTROL HOLDER LEVERS - LEVERS

#### PIAGGIO / GILERA



ART. **10355**

PORTALEVA SX / HOLDER LEVER LEFT

(Sim. CM063804)

#### PIAGGIO

FLY 50 2T('05-'07) - 4T 50('05-'07) - 4T & 25-30 KM/H 50 ('08-'11) - 4T MOT.CHIN 50 ('06-'07)  
 FLY 4T 100 ('06-'08) - 125/150 ('05-'07) - EU3 125/150 ('08-'11)  
 HEXAGON LX4 150('98-'99) - LIBERTY 2T/4T 50 ('05-'08) - 125/200 ('06) - 4T 125 ('06-'07)  
 LIBERTY 4T-2V EU3 125 ('09-'12) - 4T 125 ('06-'08) - 4T EU3 150 ('08) - 4T EU3 200 ('06-'08)  
 LIBERTY RST 125/200 ('04-'05) - RST 2T/4T 50 ('04) - SPORT 2T/4T 50 ('06-'08)  
 LIBERTY SPORT 125/200('06->) - SPORT 4T EU3 125/150/200 - MOC 2T/4T & ELLE 50 ('09->)  
 NRG POWER DT 50 ('06-'15) - NRG POWER DT SR.SPEC. 50 ('07-'08)  
 VESPA LX 2T/4T 50 ('05->) - LX 125/150 ('05-'06) - LX 125/150 EU3 IE ('06->)  
 VESPA LX 125/150 IE EU3 (09->'11) - LX 4T 4V / 4T 4V TOURING 50 ('09->) - LX 4T FL 125/150 ('09->)  
 VESPA S 2T & COLLEGE 50 ('07-'12)  
 VESPA S 4T-4V & COLLEGE 50 ('08-'12) - S 4T 150 ('08-'09)-S 4T 3V IE 125 ('12)  
 VESPA S 4T EU3 125 ('07-'08) - S 4T IE & COLLEGE 50/125/150 ('09-'12)

#### GILERA

RUNNER SP/ST 50 ('05->) - ST 125 ('05->) - 4 T 125-VXR 4T 180 ('01->) - VXR 200 ('05->)  
 TYPHOON 50 ('05-'11)



ART. **10351**

PORTALEVA SX CON LEVA DI TENUTA FRENO A MANO  
 HOLDER LEVER LEFT WITH HANDBRAKE LEVER

(Sim. 601013)

#### PIAGGIO

LIBERTY 4Y DELIVERY TNT 50 ('09) - 4T PTT (DEU) 50 ('07-'12) - RST PTT 125 ('05-'11)

#### PIAGGIO / GILERA / DERBI



ART. **10391**

LEVA DESTRA/SINISTRA  
 RIGHT/LEFT LEVER

(Sim. 497042-646833)

APPLICAZIONI APPLICATIONS	SINISTRA LEFT	DESTRA RIGHT
DERBI BOULEVARD 2T 50 ('09) - 4T 50 ('09) - 4T 125 ('08)		10391
GILERA RUNNER PUREJET 50 ('05-'06) - ST 50 ('08) - SP ST 50 ('08) - SP SIMONCELLI 50 ('08)	10391	10391
GILERA RUNNER VX EU3 (GRIMECA) 125 ('07) - VX ST 125 ('08) - VXR ST 200 ('08-'09)	10391	10391
PIAGGIO FLY 2T 50 ('05-'07) - 4T 50 ('05-'08) - FLY (GRIMECA) 125 ('05-'08) - 4T (GRIMECA) 100 ('06-'08)	10391	
PIAGGIO LIBERTY 2T SPORT 50 ('06-'08)-2T (GRIMECA) 50 ('06-'08) - 4T RST 50 ('04) - 4T RST (GRIMECA)50('05-'06)	10391	
PIAGGIO LIBERTY 4T RST PTT 125 ('05-'06)-4T (GRIMECA) 125 ('06-'09) - 4T (HENG TONG) 200 ('06)	10391	
PIAGGIO LIBERTY 4T RST SPORT (GRIMECA) 50 ('06-'08) - 4T SPORT 125('06-'09) - 4T SPORT(GRIMECA)200 ('06)	10391	
PIAGGIO NRG POWER DT (GRIMECA) 50 ('05-'08)	10391	
PIAGGIO VESPA GTS ABS 250 ('05)	10391	10391
PIAGGIO VESPA LX (GRIMECA) 125 ('05-'09) - VESPA LX (GRIMECA) 150 ('06-'07)	10391	

**PIAGGIO / GILERA**



TUBO lunghezza mm. 120

ART. **10347**

TUBO COMANDO GAS MONOCAVO  
SENZA MANOPOLE

THROTTLE CONTROL TUBE  
SINGLE CABLE WITHOUT GRIPS

**PIAGGIO**

LIBERTY 50 ('07-'05)  
LIBERTY 2T 50 ('06-'08)  
LIBERTY RST 2T 50 ('04)  
LIBERTY SPORT 2T/4T 50 ('06-'08)  
LIBERTY 4T DELIVERY SINGLE 50 ('10-'14)  
LIBERTY 4T DELIVERY TNT 50 ('09)  
LIBERTY PTT EU2 50 ('04-'05) - 4T PTT 50 ('09-'15)  
LIBERTY MOC 2T & ELLE 50 ('09-'13) - MOC 4T & ELLE 50 ('09-'16)  
NRG MC3 50 ('01-'04) - NRG PUREJET 50 ('02-'04)

**GILERA**

TYPHOON 50 ('05-'11)



MANOPOLE RICAMBIO  
GRIPS SPARE  
CIF. ART. 10291



TUBO lunghezza mm. 110

ART. **10348**

TUBO COMANDO GAS MONOCAVO  
SENZA MANOPOLE

THROTTLE CONTROL TUBE  
SINGLE CABLE WITHOUT GRIPS

**PIAGGIO**

FLY 50 4T ('06>)-FLY 100 ('04>)  
VESPA LX 2T 50 ('05-'13)  
VESPA LX 4T 50 ('05-'09)  
VESPA LX 4T-4V 50 ('09-'13)  
VESPA LX 4T-4V & COLLEGE 50 ('08-'12)  
VESPA LX 2T TOURING & 30 KM. 50 ('10-'13)  
VESPA LX 4T-4V TOURING 50 ('10-'13)  
VESPA LX 125/150 ('05-'06)  
VESPA LX EU3 125/150 ('06-'08)  
VESPA S 2T & COLLEGE 50 ('07-'12)  
VESPA S 4T-4V & COLLEGE 50 ('08-'12)  
VESPA S 4T EU3 125 ('07-'08)

**GILERA**

STALKER 50 ('04>)



MANOPOLE RICAMBIO  
GRIPS SPARE  
CIF. ART. 10272





## COPPIE MANOPOLE PAIR GRIPS



### PIAGGIO / GILERA

lunghezza / length mm. 120



ART. **10241**

CP. MANOPOLE NERE IN GOMMA  
PAIR GRIPS IN RUBBER

(Sim. 267205+267206)

Ø 22-24

PIAGGIO SFERA BASE 50  
CICLOMOTORI PIAGGIO SI' FL

lunghezza complessiva / total length mm. 127



ART. **10290**

COPPIA MANOPOLE ESTREMITA' FORATE  
PAIR GRIPS WITH OPEN END

#### PIAGGIO

BEVERLY RST 125 ('04-'07) - EU3 125 ('07-'08) - MIC EU3 125 ('07)  
BEVERLY 250 ('06-'07) - RST 250 ('04-'05) - TOURER EU3 400 ('08-'10)  
CARNABY 125 ('07-'10) - 200 ('07-'08) - 250 ('08)  
MP3 125 ('06-'08) - MP3 IE 125 ('08-'09) - MP3 250 ('06-'08) - MP3 400 ('07-'08)  
MP3 LT IE 300 ('10-'11) - Mp3 MIC 250 ('08-'09) - Mp3 MIC IE 300 ('10-'11)  
MP3 MIC 400 ('08-'10) - Mp3 E LT-IE LT SPORT400 ('08-'10)  
MP3 LT 250 ('08-'09)  
VESPA 946 4T 3V ABS 125 ('13-'15)  
VESPA 946 4T 3V ABS ARMANI 125 ('15)  
VESPA GRANTURISMO 125/200 ('06-'07) - EU3 125 ('06-'07)  
VESPA GTS EU3 125 ('07-'12) - GTS ABS 250 ('05-'12) - GTS 250 ('05-'16)  
VESPA GTS IE & TOURING 300 ('12-'15)  
VESPA GTS IE TOURING 300 ('11-'12)  
X EVO 125/250 ('07-'16) X EVO 400 ('07-'11)  
X7 EU3 125/250 ('08)  
X7 EVO IE EU3 125 - X8 125 ('04-'06) - PREMIUM EU2 125 ('06->)  
X8 PREMIUM EU3 125 ('06-'07) - X8 STREET EU2 125/150 ('06-'07)  
X8 200 ('05-'07)

#### GILERA

RUNNER 180 (>'01) - VXR 4T 180 ('01->) - VXR 200 ('05->) - SP/ST 50 ('05->)  
FUOCO IE 500 ('07->)

(SI ABBINA AL TUBO COMANDO GAS  
CIF ART. 10346 e 10349)

(COMBINES THE TROTTLE CONTROL TUBE  
CIF ART. 10346 e 10349)

lunghezza complessiva / total length mm. 120



ART. **10243**

COPPIA MANOPOLE MODELLO "SCOOTER GP"  
NERA FUSTELLATA ESTREMITA' FORATE  
PAIR GRIPS WITH OPEN END

#### PIAGGIO

LIBERTY 4T EU3 DELIVERY-SINGLE 125 ('07-'15)  
LIBERTY 4T EU3 DELIVERY TNT-NEXIVE 125 ('08-'15)  
LIBERTY ELETTRICO PPT AUT. ('11)  
LIBERTY RST PTT 125 ('05-'11)

**PIAGGIO / GILERA**

lunghezza complessiva / total lenght mm.127  
lunghezza interna / internal lenght mm.122



(SI ABBINA AL TUBO COMANDO GAS  
CIF ART. 10347)

(COMBINES THE TROTTLER CONTROL TUBE  
CIF ART. 10347)

ART. **10291**

COPPIA MANOPOLE / PAIR GRIPS

**PIAGGIO**

LIBERTY 50 ('07-'05)  
LIBERTY 2T 50 ('06-'08)  
LIBERTY RST 2T 50 ('04)  
LIBERTY SPORT 2T/4T 50 ('06-'08)  
LIBERTY 4T DELIVERY SINGLE 50 ('10-'14)  
LIBERTY 4T DELIVERY TNT 50 ('09)  
LIBERTY PTT EU2 50 ('04-'05)  
LIBERTY PTT 4T 50 ('09-'15)  
LIBERTY MOC 2T & ELLE 50 ('09-'13)  
LIBERTY MOC 4T & ELLE 50 ('09-'16)  
NRG MC3 50 ('01-'04)  
NRG PUREJET 50 ('02-'04)

**GILERA**

TYPHOON 50 ('05-'11)

lunghezza complessiva / total lenght mm.118  
lunghezza interna / internal lenght mm.112



(SI ABBINA AL TUBO COMANDO GAS  
CIF ART. 10339 e 10348)

(COMBINES THE TROTTLER CONTROL TUBE  
CIF ART. 10339 e 10348)

ART. **10272**

COPPIA MANOPOLE / PAIR GRIPS

**PIAGGIO**

FLY 50 4T ('06>) - FLY 100 ('04>)  
LIBERTY 4T EU3 125 ('06-'08)  
LIBERTY 4T 2V EU3 125 ('09-'12)  
LIBERTY 4T EU3 150('08)  
LIBERTY SPORT 4T EU3 125('06-'08)  
LIBERTY SPORT 4T EU3 150 ('08)  
LIBERTY MOC 4T EU3 150 ('09-'13)  
VESPA LX 125/150 ('05-'06) - LX 2T 50 ('05-'13)  
VESPA LX 2T TOURING & 30 KM. 50 ('10-'13)  
VESPA LX 4T 50 ('05-'09) - LX 4T-4V 50 ('09-'13)  
VESPA LX 4T-4V & COLLEGE 50 ('08-'12)  
VESPA LX 4T-4V TOURING 50 ('10-'13)  
VESPA LX EU3 125/150 ('06-'08)  
VESPA LX 4T EU3 IE 125/150 ('09-'11)  
VESPA LX TOURING 4T EU3 125 ('10-'11)  
VESPA LX TOURING 150 ('10-'12)  
VESPA LX TOURING 4T 3V IE 150 ('12-'13)  
VESPA LX FL 4T 125/150 ('09)  
VESPA S 2T & COLLEGE 50 ('07-'12)  
VESPA S 4T-4V & COLLEGE 50 ('08-'12)  
VESPA S 4T EU3 125 ('07-'08)  
VESPA S 4T IE & COLLEGE 125 ('09-'11)  
VESPA S 4T IE & COLLEGE 150 ('09-'12)

**GILERA**

STALKER 50 ('04>)





## COPPIE MANOPOLE PAIR GRIPS



### LUNGHEZZA / LENGHT mm. 120



#### ART. 10293

CP. MANOPOLE IN GOMMA NERA **ESTREMITA' FORATE**  
PAIR GRIPS IN BLACK RUBBER WITH OPEN END

LUNGHEZZA / LENGHT **mm. 120** - Ø mm. 20/24

RIGATURA DISEGNO " **HONDA** " - SCOOTER SH 150 - 300



#### ART. 10510

CP. MANOPOLE IN GOMMA EXTRA SOFT  
TERMOPLASTICA NERA **ESTREMITA' FORATE**  
PAIR GRIPS IN BLACK EXTRA SOFT RUBBER COMPOUND WITH OPEN END

LUNGHEZZA / LENGHT **mm. 120** - Ø mm. 20/24

RIGATURA DISEGNO " **YAMAHA** " -  
T-MAX - X-MAX - STRADA R6/R1 FINO AL / TILL TO 2012)



#### ART. 10515

CP. MANOPOLE IN GOMMA TERMOPLASTICA NERA  
PAIR GRIPS IN BLACK RUBBER COMPOUND

LUNGHEZZA / LENGHT **mm. 120** - Ø mm. 20/24

SCOOTER: KYMCO-HONDA-PEUGEOT-PIAGGIO-YAMAHA

### LUNGHEZZA / LENGHT mm. 128



#### ART. 10516

CP. MANOPOLE IN GOMMA TERMOPLASTICA NERA  
**ESTREMITA' FORATE**  
PAIR GRIPS IN BLACK RUBBER COMPOUND WITH OPEN END

LUNGHEZZA / LENGHT **mm. 128** - Ø mm. 20/24

SCOOTER : KYMCO-HONDA-PEUGEOT-PIAGGIO-YAMAHA



#### ART. 10519

CP. MANOPOLE IN GOMMA TERMOPLASTICA NERA  
PAIR GRIPS IN BLACK RUBBER COMPOUND

LUNGHEZZA / LENGHT **mm. 128** - Ø mm. 20/24

MODELLO " **DAKAR** " - SCOOTER - MOTO



#### ART. 10520

CP. MANOPOLE IN GOMMA TERMOPLASTICA NERA  
**ESTREMITA' FORATE**  
PAIR GRIPS IN BLACK RUBBER COMPOUND WITH OPEN END

LUNGHEZZA / LENGHT **mm. 128** - Ø mm. 20/24

MODELLO " **DAKAR** " - SCOOTER - MOTO

**COPPIE MANOPOLE RACING XM2 SCOOTER E MOTO STRADALI  
IN GOMMA MORBIDA - ESTREMITA' FORATE**

*XM2 DOUBLE SUPER SOFTS GRIPS IN RUBBER COMPOUND, OPEN END*

**LUNGHEZZA / LENGHT mm. 126**



ART. **10298-R**

CP. MANOPOLE **ESTREMITA' FORATE**

PAIR GRIPS WITH **OPEN END**

LUNGHEZZA / LENGHT **mm. 126**

COLORE NERO/ROSSO / *BLACK/RED COLOUR*



ART. **10298-B**

CP. MANOPOLE **ESTREMITA' FORATE**

PAIR GRIPS WITH **OPEN END**

LUNGHEZZA / LENGHT **mm. 126**

COLORE BLU/BIANCO / *BLUE/WHITE COLOUR*



ART. **10298-N**

CP. MANOPOLE **ESTREMITA' FORATE**

PAIR GRIPS WITH **OPEN END**

LUNGHEZZA / LENGHT **mm. 126**

COLORE NERO/GRIGIO / *BLACK/GREY COLOUR*





## COPPIE MANOPOLE PAIR GRIPS



### COPPIE MANOPOLE RACING MOTO STRADALI IN GOMMA TERMOPLASTICA - ESTREMITA' FORATE

ROAD RACING GRIPS IN RUBBER COMPOUND, OPEN END

**LUNGHEZZA / LENGHT mm. 126**



ART. **10300-R**

CP. MANOPOLE **ESTREMITA' FORATE**  
PAIR GRIPS WITH OPEN END

LUNGHEZZA / LENGHT mm. 126

COLORE NERO/ROSSO / BLACK/RED COLOUR



ART. **10300-N**

CP. MANOPOLE **ESTREMITA' FORATE**  
PAIR GRIPS WITH OPEN END

LUNGHEZZA / LENGHT mm. 126

COLORE NERO/GRIGIO / BLACK/GREY COLOUR



ART. **10300-B**

CP. MANOPOLE **ESTREMITA' FORATE**  
PAIR GRIPS WITH OPEN END

LUNGHEZZA / LENGHT mm. 126

COLORE BLU/BIANCO / BLUE/WHITE COLOUR

**LUNGHEZZA / LENGHT mm. 120**



ART. **10294**

CP. MANOPOLE IN GOMMA NERA  
PAIR GRIPS IN BLACK RUBBER

LUNGHEZZA / LENGHT mm. 120 - Ø mm. 20/24

CROSS/ENDURO - ADATTABILE SU SCOOTER



ART. **10262-A**

COMANDO **STARTER ANULARE** AL MANUBRIO  
RING CONTROL STARTER TO HANDLEBAR

SCOOTER e MOTO



ART. **10262-L**

KIT **STARTER A LEVA** PER FISSAGGIO SU CARTER  
(COMPLETO DI FASCETTA)

STARTER LEVER KIT FOR FIXING ON CARTER  
(WITH CLAMP FOR FIX)

SCOOTER e MOTO



ART. **10245**

SDOPPIATORE CAVO GAS

THROTTLE CABLE SPLITTER

SCOOTER PIAGGIO

(GENERICO PER QUALSIASI ALTRA APPLICAZIONE)  
(GENERIC FOR ANY OTHER APPLICATION)



ART. **10384**

SDOPPIATORE CAVO GAS

(Sim. 269571)

THROTTLE CABLE SPLITTER



**APRILIA** : SPORT CITY ONE 2T 50 ('08-'11) - SR MOTARD 2T 50 ('12-'14)  
**GILERA** : DNA 50 ('00-'07) - DNA GP EXPERIENCE 50 ('03-'04) - EAGLET 50 ('96)  
EASY MOVING 50 ('95-'96) - GSM 50 ('99-'00) - ICE 50 ('01-'05) - RUNNER 50 ('97-'00)  
RUNNER FX 125/180 - POGGIALI 50 ('02) - PUREJET 50 ('02-'11) - PUREJET ST 50 ('08)  
RUNNER SP 50 ('02-'12) - SP SPEC.EDIT. 50 ('07) - SP ST & SIMONCELLI 50 ('08-'09)  
STALKER 50 ('07-'11) - NAKED 50 ('08) - SPEC.EDIT. 50 ('07-'08) - STORM EU2 50 ('07)  
TYPHOON 50 ('01-'11) - TYPHOON EU2 2T 50 ('10-'12) - TYPHOON EU3 2T CH 50 ('11)  
**PIAGGIO** : FLY 2T 50 ('05-'11) - HEXAGON 125 ('94-'97) - HEXAGON LX LXT 125 ('98-'99)  
LIBERTY 50('97-'05)-2T 50 ('06-'08)-RST 2T 50 ('04)-SPORT 2T 50 ('06-'08)-PTT EU2 50 ('04-'05)  
LIBERTY MOC 2T & ELLE 50 ('09-'13) - NRG EXTREME 50 ('99-'00) - NRG MC3 50 ('01-'04)  
NRG POWER DD 50 ('05-'15) - DD SR.SPEC. 50 ('07-'12) - NRG POWER DT 50 ('06-'15)  
NRG POWER DT SR.SPEC.50 ('07-'08)-POWER PUREJET 50 ('04-'09) - PUREJET 50 ('02-'04)  
NRG RST MC2 50 ('94-'98) QUARTZ 50 ('92-'96)-SFERA RST 50('95-'97)-SKIPPER 125 ('95-'97)  
SKIPPER LX 125 ('98-'99) - VESPA ET2 50 ('97-'05) - ET2 INIEZIONE 50 ('07-'00)  
VESPA LX 2T 50 ('05-'13) - VESPA LX TOURING & 30 Km. 2T 50 ('10-'13) - V. LXV 2T 50 ('06-'09)  
VESPA LXV NAVY 2T 50 ('08) - VESPA PRIMAVERA 2T 50 ('13-'15) - V. S 2T & COLLEGE 50 ('07-'12)  
VESPA SPRINT 2T 2V 50 ('14-'15) - ZIP 50 ('95-'96 / '00-'04) - ZIP 2T 50 ('08-'13) - ZIP F.R 50 ('93-'94)  
ZIP F.R. RST 50 ('96-'97) - ZIP RST 50 ('96-'99) - ZIP SP 50 ('96-'04) - ZIP SP EU2 50 ('06-'13)  
APE 50 ('09-'16) - APE MIX 50 ('98-'08) - APE RST 2T 50 ('99-'03)





## INTERRUTTORI STOP STOP SWITCHES



ART. **9128**

INTERRUTTORE STOP UNIVERSALE A FILETTO  
PER COMANDI SCOOTER

(Sim. 126899)



ART. **9128-TOM**

INTERRUTTORE STOP UNIVERSALE A FILETTO  
(TIPO TOMMASELLI)  
PER COMANDI SCOOTER



ART. **9128-MAL**

INTERRUTTORE STOP INSERIMENTO A SCATTO  
(TIPO TOMMASELLI)  
ADATTABILE MALAGUTI



ART. **9129**

INTERRUTTORE STOP

(Sim. 583575)

**PIAGGIO:**

BEVERLY RST 125 ('04-'06) - 250 ('04-'05) - 500 ('05-'06) - SPORT 250 ('06)-EU3 250-400-500 ('02-'04) - 500 ('06)  
BEVERLY TOURER EU3 125-250-400 ('08)  
CARNABY 125-200 ('07-'08) - CARNABY 250 ('08)  
FLY 2T 50 ('05) - 4T 50 ('05-'07) - 4T 100 ('06-'07)-150 ('05)-125 ('05-'06) - 4T MOTORE CHIN 50 ('06-'07)  
LIBERTY RST 2T 50 ('04) - RST 4T 50 ('04-'06) - RST 125 ('04-'05) - RST PTT 125 ('05-'06) - RST 200 ('04)  
LIBERTY 4T 125-200 ('06) - 2T 50 ('06) - SPORT 2T 50 ('06) - SPORT 4T 50-125-200 ('06)  
MP3 250 ('06-'07)-NRG POWER PUREJET 50 ('04-'08) - NRG POWER DD 50 ('05-'08) - POWER DT 50 ('06-'08)  
X8 125-200 ('04-'06)-250 ('05-'06)-400 ('06)-STREET EURO2 125-150 ('06)-PREMIUM EURO2 ('06)-X9 200 ('02-'03)  
X9 EVOLUTION 125('03-'06)-200 ('03) - X9 250 ('04-'06) - 500 ('03-'07)  
VESPA LX 2T - 4T 50 ('05-'08) - LX 125 - 150 ('05-'06) - LX EURO3 125-150 ('06-'08)-VESPA GTS 250 ('05-'06)  
VESPA GRANTURISMO 125 - 200 ('06-'07)

**GILERA:**

NEXUS 500 ('03-'05)-EURO3 250- 500 ('06)-SP EURO3 250-500('06-'07)-RUNNER SP 50('05-'06)-SP SC 50('06-'07)  
SP RACE 50('06)-PUREJET 50 ('05-'06) - PUREJET RACE 50 ('06) - VX 4T 125 ('05-'06) - VX RACE 4T 125 ('06)  
VX SC 4T 125 ('06-'07)-VXR 4T 200 ('05-'06) - VXR RACE 4T 200 ('06)

## INTERAUTTORI

### SWITCHES



#### ART. 9080-A

PULSANTE AVVIAMENTO / STARTING BUTTON

(Sim.58057R-293549)

**PIAGGIO:** BEVERLY 250 -500 -EU3 125-400-500-EU3 MIC 125-250-IE EU3 250  
BEVERLY RST 125-250-SPORT 250 TOURER EU3 125-250-400-CARNABY 125-200-250  
FLY 125-150-FLY 2T/4T 50-FLY 4T 100-MOTOR CHIN 50-EU3 125-150-HEXAGON GT-GTX 125-180-250  
HEXAGON LX-LXT 125-180-LX4 125-LIBERTY 50-125-150- 2T/4T -SPORT EU3 - RST-PTT EU2-NRG EXTREME-MC3  
POWER DD-PUREJET-SFERA RST-SKIPPER 4T-LX 125-150-VESPA ET2 50 - ET4 125-150-GRANTURISMO 125-200  
X EVO 125-250-400-X8 -EURO3-PREMIUM-STREET-X9-AMALFI-EVOLUTION-ZIP 50-125-4T 50-100-SP-SP EU2 50  
**GILERA:** RUNNER 50-FX-FXR 125-180-PUREJET 50 -SP 50-SP ST 50-VX 125 -VX 4T EU3 125 -VX 4T ST EU3 125  
VX RACE 125-VX SC 125-VX125 -VXR 200 -VXR 4T ST EU3 200 -VXR EU3 200-VXR RACE 200-STALKER 50  
STALKER SPECIAL EDITION 50 -STORM EU2 50 - TYPHOON 50



#### ART. 9081-A

PULSANTE AVVIAMENTO / STARTING BUTTON

(Sim.294398-294097)

**PIAGGIO:** FREE 50-100-DELIVERY-FL 50 -HEXAGON 125-150-NRG 50 ('94-'96)  
NRG RST MC2 50 ('96-'98)-NTT 50-QUARTZ-SFERA 50 - SKIPPER 125-150-SKR CITY 80  
ZIP-ZIP FAST RAIDER -RAIDER RST-RST-SP 50-APE FL3 EUROPA 50 ('96-'99)-RST MIX 50 ('99-'05)  
**GILERA:** TYPHOON 50 ('94-'97)-125 ('95-'98)-X 50 ('98-'99)-TYPHOON X-XR 125 ('99-'00)-XR 50 ('00)



#### ART. 9076-F

DEVIO FRECCHE / INDICATOR LENSES SWITCH

(Sim.294723)

**PIAGGIO:** LIBERTY 50('97-'05)-4T 50 (00-'02)-PTT EU2 50 (04-'05)-125-150 (01-'02)  
SFERA 125 (95-'97)-VESPA ET2 50 (97-'05)-ET2 INIEZIONE 50 (97-'00)-ET4 50 (00-'05)  
ET4 125 (96-'98)-ET4 125-150 (99-'02)-GRANTURISMO 125-200 (03-'07)-EU3 125(06-'07)  
GTS EU3 125(07-'08)-GTS SUPER 300 (08)-LX 2T/4T 50 (05-'08)-LX 125-150 (05-'06)  
LX EU3 125-150 (06-'08)-VESPA S 2T 50 (07-'08) - S 4T EU3 125 (07-'08)



#### ART. 9078-F

DEVIO FRECCHE / INDICATOR LENSES SWITCH

(Sim.638708-581409  
Apr.8127892)

**PIAGGIO:** X9 125 ('01-'02)- 250 ('00-'01) - X9 EVOLUTION 125 ('05-'08) - X9 EVOLUTION EU3 125 ('07)  
X9 EVOLUTION 250 ('04) - X9 EVOLUTION 500('03-'07) - X9 EVOLUTION ABS 500 ('06-'07)  
**APRILIA:** SCARABEO LIGHT 250 ('06-'08)



#### ART. 9077-F

DEVIO FRECCHE / INDICATOR LENSES SWITCH

(Sim.294917-290682)

**PIAGGIO:** FREE 50 (92-'94)-100 (02-'03)-DELIVERY 50 (00-'01)-FREE FL 50 (95-'02)  
NRG 50 (94-'96)-NRG RST MC2 50('96-'98)-NTT 50 (95-'96)-QUARTZ 50 (92-'96)-SFERA 50 (91-'93)  
MAQUILLAGE 2 50('94)-SKIPPER 125-150 (94-'97)-SKR CITY 80 (99)-VELOFAX 50 (96-'99)-ZIP 50 (92-'93)  
FAST RAIDER 50 (93-'94)-FR. RST 50('96-'97)-RST 50 ('96-'99)-SP 50 ('96-'00)  
APE FL3 EUROPA 50 ('96-'99)-RST MIX 50 ('99-'05)  
**GILERA:** TYPHOON 50 (94-'95)-X 50 (98-'99)-XR 50 (00)-125(95-'98) - X-XR 125 (99-'00) - STORM 50 (94-'95)



#### ART. 9075-L

DEVIO FRECCHE 3 ATTACCHI  
INDICATOR LENSES SWITCH, 3 ATTACKS

(Sim.638628-58056R-  
294342)

**PIAGGIO:** BEVERLY 250 ('06-'07) - 500 ('02-'06)-EU3 125 ('07)-400 ('06-'07)-500 ('06-'08)-EU3 MIC 125-250 ('07)  
EU3 SPORT 125 ('07)-IE EU3 250 ('06-'07)-RST 125 ('04-'07)-250 ('04-'05)-SPORT 250 ('06-'07)-TOURER 250('08)  
CARNABY 125-200('07-'08)-FLY 125-150('05-'07)-2T 50('05-'07)-4T 50('05-'07)4T 100 ('06-'07)-FLY EURO3 ('07-'08)  
HEXAGON GT-GTX 250 ('98-'99) - GTX 125-180 ('00) - LX-LXT 125-180 ('98-'99)-LX4 125 ('98-'99)-LIBERTY 200 ('06)  
LIB 2T 50('06-'07)-2T RST('04)-2T SPORT 50 ('06-'07)-4T 125 ('06-'07) - 4T EURO3 125-200 ('07-'08)-4T RST 50 ('04-'06)  
LIB 4TSPORT 50 ('06)-4T SPORT EURO3 50('07)-4T SPORT EURO3 125-200('06-'07)-RST 125-200 ('04-'05)  
LIB.RST PTT 125 ('05-'06)-SPORT 125-200 ('06) - MP3 125 ('07) - 250 ('06-'07) - 400 ('07)-NRG EXTREME 50 ('99-'00)  
NRG MC3 50 ('01-'04) - POWER DD 50 ('05-'07)-POWER DT 50 ('06-'07)-POWER PUREJET 50 ('04-'07)-SKIPPER 4T 125  
150 ('00-'02) - LX 125-150 ('98-'99)-SUPER HEXAGON GTX 12" 125-180('01-'02)-X EVO 125-250 ('08)-X EVO 400 ('07-'08)  
X7 EURO 3 125-250 ('08)-X8 125 ('05-'06)-X8 200 ('05-'07)-X8 EU3 250 ('05-'08)-X8 EU3 400 ('06-'08)-X8 PREMIUM EU2  
125 (06-'07)-X8 STREET EU2 125 (06)-150 (06-'08)-ZIP 50 (00-'04)-125 ('00-'02)-4T 50 ('00-'07)-4T 100(06-'08)-SP 50('01-'04)  
SP EURO2 50 ('06-'08)  
**GILERA:** FUOCO 500 ('07-'08) -RUNNER 50 (97-'00)-FX-FXR 125-180 (97-'02)-PUREJET 50 (02-'07) -ST 50('08) - SP 50  
(05-'07)-SPEC.EDIT.'07)-SP ST 50('08)-VX 125 (05-'06)-VX4T EU3 125 (07)-VXR 4T ST EU3 125 (08)-VX RACE 125(06)  
VX SC 125(06-'07)-VX-VXR 125-200 (02-'04)-VXR 200 (05-'06)-VXR EU3 200 (07)-VXR RACE 200(06)-STALKER 50('97-'08)  
STALKER SPECIAL EDITION 50 ('07-'08) - STORM EURO2 50 ('07) - TYPHOON 50 ('01-'07)







## INTERRUTTORI SWITCHES

### ART. 9083-CX

PULSANTE CLACSON / HORN BUTTON

(Sim.58058R-293550)



**PIAGGIO:** BEVERLY 250-500-EU3 125-400-500- EU3 MIC 125-250-EU3 SPORT 125- BEVERLY IE EU3 250-RST 125-250-SPORT 250-TOURER EU3 125-250-400-CARNABY 125-200-250 FLY 50-2T 50-4T 50- 4T 100 4T MOTORE CHIN 50-EU3 125-150-HEXAGON GT-GTX 250-GTX 125-150 HEXAGON LX-LXT 125-180-LX4 125 - SUPER HEXAGON GTX 12" 125-180 LIBERTY 50-125-200-2T 50-T4 -50-125-4T EU3 125-150-200 4T EU3 DELIVERY 125-4T RST 50 LIBERTY 4T SPORT 50-4T-SPORT-EU3 125-150-200-PTTEU2 50-RST 125-200 - RST PTT 125-SPORT 125-200 NRG EXTREME 50 - MC3 50 - POWER DD 50-DD SERIE SPECIALE 50 - POWER DT 50-SFERA RST 50 SKIPPER 4T 125-150 - LX 125-150- VESPA ET2 50-ET2 INIEZIONE 50-ET4 50-125-150-GRANTURISMO 125-200 X EVO 125-250-40 - X8 125-200-EU3 250-400-PREMIUM EU2 125-EU3 125-STREET EU2 125-150-X9 125-200-250 X9 AMALFI 180-EVOLUTION 125-200-250-500 - ZIP 50-4T 50-100 - SP50-SP EU2 50 - 125  
**GILERA:** RUNNER 50-FX-FXR 125-180-PUREJET 50-SP 50-VX 125-VX4T EU3 125 - VX RACE 125 - VX SC 125-VX-VXR 125-200-VXR 4T ST 200 - VXR EU3 200-VXR RACE 200 STALKER 50-SPECIAL EDITION-STORM EU2 50-TYPHOON 50

### ART. 9084-CX

PULSANTE CLACSON / HORN BUTTON

(Sim.292364-290679)



**PIAGGIO:** FREE 50 ('92-'94) -100 ('02-'03)-DELIVERY 50 ('00-'01)-FREE FL 50 ('95-'02) NRG 50 ('94-'96)-RST MC2 50 ('96-'98)-NTT 50 ('95-'96) - QUARTZ 50 ('92-'96) SFERA 50 ('91-'93)-MAQUILLAGE 2 50 ('94)-SKIPPER 125-150 ('94-'97) - SKR CITY 80 ('99) VELOFAX 50 ('96-'99) - ZIP 50 ('92-'96) - BIMODALE 50 ('94-'97)-FAST RAIDER 50 ('93-'94) ZIP FAST RAIDER RST 50 ('96-'97)-RST 50 ('96-'99)-SP 50 ('96-'00) APE FL-FL2 50 ('89-'95) - FL3 EUROPA 50 ('96-'99) - RST MIX 50 ('99-'05)  
**GILERA:** TYPHOON 50 ('94-'95)-X 50 ('98-'99)-XR 50 ('00)-125('95-'98) - X-XR 125 ('99-'00) STORM 50 ('94-'95) - EASY MOVING 50

### ART. 9071-L

DEVIO LUCI / LIGHTS SWITCH

(Sim.293571)



**PIAGGIO:** LIBERTY 50 ('97-'05)-125-150 ('01-'02) - 4T ('00-'02) - PTT EU2 50 ('04-'05) SFERA RST 50 ('95-'97)- SFERA 125 ('95-'97) VESPA ET2 50 ('97-'05)-INIEZIONE 50 ('97-'00) - VESPA ET4 50 ('00-'05) - ET4 125-150 ('99-'02)

### ART. 9072-L

DEVIO LUCI / LIGHTS SWITCH

(Sim.294877-293572)



**PIAGGIO:** LIBERTY 50 ('97-'05) - 4T 50 ('00-'02) - PTT EU2 50 ('04-'05) - 125 ('98-'02) SFERA 125 ('95-'97) - SFERA RST 50 ('95-'97)-VESPA ET2 50 ('97-'05)- ET2 INIEZIONE 50 ('97-'00) ET4 50 ('00-'05) - ET4 125 ('96-'02)-GRANTURISMO 125 ('03-'07)-GRANTURISMO EU3 125 ('06-'07) GRANTURISMO 200 ('03-'07)-GTS 250 ('05-'14)-GTS 4T IE SUPER 125 ('09-'14)-GTS ABS 250 ('05-'12) GTS EU3 125 ('07-'12) - GTS IE 300 ('12-'14) - GTS IE TOURING 300 ('11-'12) - GTS SUPER 300 ('08-'14) GTS SUPER SPORT 300 ('10-'13)-LX 2T 50 ('05-'13)- LX 2T TOURING 50 ('10-'13) - LX 4T 50 ('05-'08) LX 125 ('05-'06)-LX 4T EU3 TOURING 125 ('10-'11)-LX 4T 3V IE - TOURING 125/150 ('12-'13) LX 150 ('05-'06) - LX 4T FL 125/150 (2009)-LX 4T-4V 50 ('09-'13) - LX 4T-4V TOURING 50 ('10-'13) LX EU3 125/150 ('06-'08) - LX EU3 IE 125/150 ('09-'11)-LX TOURING 150 ('10-'12) VESPA S 2T & COLLEGE 50 ('07-'12) - S 4T-4V & COLLEGE 50 ('08-'12) VESPA S 4T 150 ('08-'09) - S 4T 3V IE 125 (2012) - S 4T EU3 125 ('07-'08) - S 4T IE & COLLEGE 125/150 ('09-'11)

### ART. 9070-L

DEVIO LUCI / LIGHTS SWITCH

(Sim.642968-294434)



**PIAGGIO:** FLY 4T 2V 50 ('13-'15) - FLY 4T 2V 25-30KM-H 50 ('12-'14) - FLY 4T 4V 50 ('12-'13) FLY 4T 100 (2008) - LIBERTY 2T 50 ('06-'08)-2T SPORT 50 ('07-'08)-4T 50 ('05-'08) LIBERTY 4T 2V IE PTT 125 (2012)- 4T DELIVERY 50 ('10-'14)-4T PTT 50 ('07-'12) LIBERTY 4T PTT-DOUB 50 ('09-'12)- 4T SPORT 50 ('07-'08) - MOC 2T/4T & ELLE 50 ('09-'13) NRG POWER DD 50 ('07-'13)-NRG POWER PUREJET 50 ('10-'11) ZIP 2T 50 ('08-'13) - ZIP 4T 50 ('06-'13) - ZIP SP EU2 50 ('06-'13) - ZIP 4T 100 ('06-'10)  
**GILERA:** RUNNER POGGIALI 50 ('02)-PUREJET 50 ('02-'07)-PUREJET ST ('08-SP 50 ('02-'07) RUNNER SP SPECIAL EDITION 50 ('07) - STALKER 50 ('97-'08)-SPECIAL EDITION 50 ('07-'08) STORM EU2 50 ('07) - TYPHOON 50 ('05-'08)



## INTERRUTTORI

### SWITCHES

#### ART. 9074-L

DEVIO LUCI CON PASSING / LIGHTS SWITCH WITH PASSING (Sim.642670-294341)



**PIAGGIO:** BEVERLY 250-500-EU3 125-400-500-EU3 MIC 125-150  
 BEVERLY EU3 SPORT 125-IE EU3 250-RST 125-250 SPORT 250-TOURER EU3 125-250-400  
 CARNABY 125-200-250-FLY 125-150-EU3 125-150  
 HEXAGON GT-GTX 250-GTX 125-180-LX4 125-SUPER HEXAGON GTX12" 125-180  
 LIBERTY 200-4T 125-4T EU3 125-150-200-4T SPORT EU3125-150-200-RST 125-150  
 LIBERTY SPORT 125-200 - MP3 125-250-400-SKIPPER 4T 125-150-LX 125-150  
 X EVO 125-250-400-X7 EU3 125-250 - X8 125-200-EU3 250-400-X8 PREMIUM EU2 125  
 X8 PREMIUM EU3 125-STREET EU2 150 -X9 125-200-250-500-AMALFI 180  
 X9 EVOLUTION 125-200-250-500-ABS 500-EU3 125  
**GILERA:** FUOCO 500 ('07-'08)-RUNNER FX/FXR 125/180 ('97-'02)-VX 125 ('05-'06)  
 RUNNER VX 4T EU3 125 ('07)-4T ST EU3 125 ('08)-VX RACE 125 ('06)-VX SC 125 ('06-'07)  
 RUNNER VX-VXR 125-180 ('00-'01)-VX-VXR 125-200 ('02-'04)-VXR 200 ('05-'06)  
 RUNNER VXR 4T ST EU3 200 ('08)-VXR EURO3 200 ('07)-VXR RACE 200 ('06)

#### ART 8945

COMMUTATORE A CHIAVE / SWITCH (Sim.643133-580621)



**PIAGGIO:** FLY 2T 50-4T 50 ('05-'07)-4T 100 ('06-'08)-4T CHIN 50 ('06-'07)  
 FLY 125-150('05-'07)-EU3 125/150 ('07-'08)-HEXAGON GT-GTX 250 ('98-'00)-LX4 125 ('98-'99)  
 SUPER HEXAGON GTX 12" 125-180 ('01-'02) - LIBERTY 50('97-'05)-125-150('01-'02) - 200 ('06)  
 LIBERTY 2T ('06-'08)-2T RST 50 ('04)-2T SPORT 50 ('06-'08)-4T 50 ('00-'08)-4T EU3 125 ('07-'08)  
 LIBERTY 150('08)-200('06-'08)-4T EU3 DELIVERY 125('08)-4T SPORT 50 ('06-'08)-SPORT EU3 125 ('06-'08)  
 LIBERTY PTT EU2 50 ('04-'05)-RST 125-200 ('04)-RST PTT 125 ('05-'06)-NRG POWER DD 50 ('05-'08)  
 NRG DD SERIE SPEC.('07-'08)-DT 50 ('06-'08)-DT SERIE SPEC.50('07-'08)-PUREJET 50 ('04-'08)  
 SKIPPER 4T 125-150 ('00-'02) - VESPA ET2 50 ('97-'05)-ET4 50 ('00-'05)-ET4 125-150 ('99-'02)  
 VESPA LX 125-150 ('05-'06)-LX 4T 50 ('05-'08)-LX EU3 125-150 ('06-'08)-LXV 2T 50 ('06-'08)  
 LX 2T NAVY 50 ('08)-LXV 4T EU3 125 ('06-'08)-LX NAVY EU3 125 ('08)-S 2T 50 - S4T EU3 125 ('07-'08)  
 X7 EU3 125-250 ('08) - X9 125 ('01-'02)-200 ('02-'03)-250 ('00-'01)-500 ('01-'02) - X9 AMALFI 180 ('00-'03)  
 ZIP 50 ('00-'04) - 125 ('00-'02)-4T 50 ('00-'08)-4T 100 ('06-'08)-SP 50 ('01-'04) - SP EU3 50 ('06-'08)  
**GILERA:** ICE 50 ('01-'05)-RUNNER 50 ('97-'00)-FX-FXR 125-180 ('97-'02)-PUREJET 50 ('02-'07) -ST 50 ('08)  
 RUNNER SP 50 ('05-'07) - RUNNER SP SPEC.EDIT.50 ('07)-SP ST 50('08)-VX 125 ('05-'06) - VX4T EU3 125 ('07)  
 VXR 4T ST EU3 125 ('08) - VX RACE 125 ('06) - VX SC 125 ('06-'07)-VX-VXR 125-200 ('02-'04) - VXR 200 ('05-'06)  
 VXR EU3 200 ('07) - VXR RACE 200 ('06)

#### ART. 8944

COMMUTATORE A CHIAVE / SWITCH (Sim.582951)



**PIAGGIO:** BEVERLY 125-200('01-'03)-250('06-'07)-500('02-'04)-CRUISER 250-500('07-'08)  
 CRUISER EU3 125 ('07)-BEVERLY EU3 400 ('06-'07) - EU3 500 ('06-'08)-EU3 MIC 125-250 ('07)  
 BEVERLY EU3 SPORT 125 ('07)-IE EU3 250 ('06-'07)-RST 125 ('04-'07)-RST 250 ('04-'05)  
 BEVERLY TOURER EU3 125-250-400 ('08) - CARNABY 125-200 ('07-'08) - 250 ('08)  
 VESPA GRANTURISMO 125-200 ('06-'07) - GT 60 EU3 250('06-'07)  
 VESPA GTS EU3 125('07-'08)-GTS SUPER 300('08)-GTS, GTS ABS 250('05-'08)  
 VESPA GTV 125('07-'08)-GTV 250('06-'07) - GTV 4T NAVY EU3 125-250 ('08)  
 X EVO 125-250 ('07)-400('07-'08) - X8 125 ('04-'06)-X8 200 ('05-'07)-X8 EU3 250 ('05-'08)  
 X8 EU3 400 ('06-'08) - PREMIUM EU2 ('06)-EU3 125 ('06-'07)-X8 STREET EU2 125('06)-150('06-'08)  
 X9 EVOLUTION 125('03) - 125('05-'06)-200 ('03)-250 ('04)-250('06)-500 ('03-'07) - ABS 500 ('06-'07)  
 X9 EU3 125 ('07)

#### ART. 8947

COMMUTATORE A CHIAVE / SWITCH (Sim.580639)



**PIAGGIO:** NRG EXTREME 50 ('99-'00) - NRG MC3 50 ('01-'04)- PUREJET 50 ('02-'04)  
 ZIP RST 50 ('96-'99)  
**GILERA:** TYPHOON X 50 ('98-'99) - XR 50 ('00) - X-XR 125 ('99-'00)  
 STALKER 50 ('97-'08) - NAKED 50 ('08) - SPECIAL EDITION 50 ('07) - STORM EURO3 50 ('07)





## GRUPPI OTTICI HEADLIGHTS



ART. **1624**

GRUPPO OTTICO ANTERIORE COMPLETO  
**SENZA** PORTALAMPADA

HEADLIGHT **WITHOUT** BULB SOCKET

LIBERTY 50 ('97-'05) - LIBERTY 4T 50 ('00-'02)  
VESPA ET2 50 ('97-'05) - VESPA ET2 INIEZIONE 50 ('97-'00)  
VESPA ET4 50 ('00-'05)

(Sim.293599)



ART. **1626**

GRUPPO OTTICO ANTERIORE COMPLETO  
CON PORTALAMPADE

HEADLIGHT **WITH** BULB SOCKETS

LIBERTY 125 - 150 ('01-'02)  
VESPA ET4 125-150 ('99-'02)

(Sim. 294277)



ART. **7368-AC**

CORNICE PER GRUPPO OTTICO ANTERIORE  
IN ABS CROMATA

HEADLIGHT RIM, CHROMED ABS

LIBERTY 50 ('97-'05) - LIBERTY 4T 50 ('00-'02)  
LIBERTY 125-150 ('01-'02)  
VESPA ET2 50 ('97-'05) - VESPA ET2 INIEZIONE 50 ('97-'00)  
VESPA ET4 50 ('00-'05) - VESPA ET4 125-150 ('99-'02)

(Sim. 560671)



## CATARINFRANGENTE REFLECTOR

**PIAGGIO / GILERA U.S.A**



OMOLOGAZIONE - APPROVAL  
02550.36  
SAE A99DOT  
SIEM 7620



### ART. **1698-OR**

CATARINFRANGENTE SIEM OMOLOGATO (Sim. 291081 - 638745)  
REFLECTOR, SIEM APPROVED

mm.90x25  
spessore mm.7  
interasse pioli fissaggio mm.50

specifico per veicoli / *specific for vehicles:*  
**GILERA-PIAGGIO U.S.A**

PIAGGIO:  
FREE 50 (92-94) - FREE FL 50 (95-02)  
FREE DELIVERY 50 (00-01) - FREE 100 (02-03)  
NRG 50 (94-96) - NRG EXTREME 50 (99-00)  
NRG MC3 50 (01-04) - NRG PUREJET 50 (02-04)  
NRG RST MC2 50 (96-98)  
NTT 50 (95-96)  
QUARTZ 50 (92-96)  
SKIPPER 125 (94-97)  
SKR CITY 80 (99)  
MP3 RL SPORT - BUSINESS 500 (11-12)  
MP3 300 LT BUSINESS-SPORT ABS-ENJOY 300 (14-16)  
MP3 IE E4 LT BUSINESS - SPORT ABS 300 (16-18)  
MP3 400 (07-08) - MP3 IE LT  
MP3 IE LT SPORT 400 (08-10)  
MP3 IE LT TOURING 400 (11)  
MP3 LT BUSINESS ABS 500 (14-16)  
MP3 LT E4 SPORT-BUSINESS 500 (16-18)  
MP3 LT SPORT - BUSINESS 500 (11-13)  
MP3 MAXI SPORT E4 ABS 350 (18-19)  
MAXI SPORT-BUSINESS ADVANCED E4 ABS 500 (18-19)  
MP3 MIC 400 (08-10)  
MP3 RL TOURING 400 (11)  
MP3 SPORT ABS 500 (14-16)

GILERA:  
TYPHOON 50 (01-08) - TYPHOON 50 (09-11)

generico : applicazioni varie  
*generic : various applications*

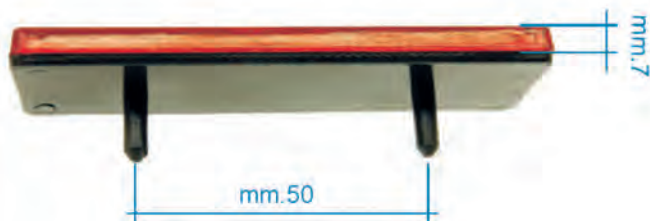





## MOTORINI AVVIAMENTO

### STARTER MOTORS



INTERASSE FORI D'ATTACCO mm.69

ART. **8993**

MOTORINO AVVIAMENTO

**MOTORI/ENGINE MINARELLI - YAMAHA**

SCOOTER APRILIA - MBK - MALAGUTI - BETA



INTERASSE FORI D'ATTACCO mm.60

ART. **8995**

MOTORINO D'AVVIAMENTO

(Sim.82530R-286172)

**MOTORI/ENGINE PIAGGIO-GILERA SCOOTER 50 cc.**

#### PIAGGIO

DIESIS 50 ('01) - FLY 2T 50 ('05-'07) - FREE 50 ('92-'94) - FREE FL 50 ('95-'02)  
FREE DELIVERY 50 ('00-'01) - LIBERTY 50 ('97-'05) - LIBERTY 2T 50 ('06-'08)  
LIBERTY 2T RST 50 ('04)-LIBERTY 2T SPORT 50 ('06-'08)-PTT EU2 50 ('04-'05)  
NRG 50 ('94-'96) - NRG EXTREME 50 ('99-'00)-NRG MC3 50 ('01-'04)  
NRG POWER DD 50 ('05-'08) - NRG DT 50 ('06) - NRG RST MC2 50 ('96-'98)  
NTT 50 ('95-'96) - QUARTZ 50 ('92-'96) - SFERA 50 ('91-'93)-MAQUILLAGE2 50 ('94)  
VESPA ET2 50 ('97-'05)-ET2 INIEZIONE 50 ('97-'00) - VESPA LX 2T 50 ('05-'08)  
VESPA LXV 2T 50 ('06-'08) - LXV 2T NAVY 50 ('08) - VESPA S 2T 50 ('07-'08)  
ZIP 50 ('92-'04)-RST 50('96-'99)-BIMODALE 50 ('94-'97) - FAST RAIDER 50 ('93-'94)  
ZIP F.R. RST 50 ('96-'97)-SP 50 ('96-'04)-SP EU2 50 ('06-'08)

#### GILERA

DNA 50 ('00-'07) - GP EXPERIENCE 50 ('03-'04)-EASY MOVING 50 ('95-'96)  
ICE 50 ('01-'05) - RUNNER 50 ('97-'00) - RUNNER POGGIALI 50 ('02)  
RUNNER SP 50 ('02-'07) - RUNNER SP EDIZIONE SPECIALE 50 ('07)  
RUNNER SP ST 50 ('08) - STALKER 50 ('97-'08) - EDIZ. SPECIALE 50 ('07-'08)  
STALKER NAKED 50 ('08) - STORM 50 ('94-'95)-STORM EU2 50 ('07)  
TYPHOON 50 ('94-'97) - X 50 ('98-'99)-XR 50 ('00)

## STATORE

### STATOR



ART. **9159**

STATORE / STATOR

(Sim.830294)

SCOOTER **PIAGGIO-GILERA 50 cc.**

#### PIAGGIO

FREE FL 50 ('95-'02) - FREE DELIVERY 50 ('00-'01) - LIBERTY 50 ('97-'02)  
NRG 50 ('94-'96) - NRG RST MC2 50('96-'98) - NRG EXTREME 50 ('99-'00)  
NTT 50 ('95-'96) - QUARTZ 50 ('92-'96) - SFERA 50 ('91-'93) - RST 50 ('95-'97)  
SKR CITY 80 ('99) - ZIP 50 ('92-'96) - ZIP RST 50('96-'99)  
ZIP FAST RIDER RST 50 ('96-'97) - ZIP SP 50 ('96-'00)

#### GILERA

EASY MOVING 50 ('95-'96) - RUNNER 50 ('97-'00) - STALKER 50 ('97-'02)  
STORM 50 ('94-'95)-TYPHOON 50 ('94-'97) - X 50 ('98-'99) - XR 50 ('00)

## RINVI MOTORINO AVVIAMENTO

### STARTER FREE-WHEELS



ART. **8970**

RINVIO MOTORINO AVVIAMENTO

(Sim. 82958-R)

SCOOTER

**PIAGGIO-GILERA-APRILIA 50 cc.**

**PIAGGIO:**

FLY - FREE - LIBERTY 2T - NRG - NTT - QUARTZ-SFERA-VESPA E12  
VESPA LX-LXV 2T-VESPA S 2T - ZIP

**APRILIA:**

SCARABEO 2T-SPORT CITY ONE 2T - SR R FACTORY IE/CARB.-SR STREET

**GILERA:**

DNA - RUNNER - RUNNER SP - STALKER-STORM-TYPHOON-X-XR



ART. **8975**

RINVIO MOTORINO AVVIAMENTO

(Sim.483537)

SCOOTER

**PIAGGIO-GILERA-APRILIA 50 cc. 2T**

**PIAGGIO**

DIESIS 50 (01) - FLY 2T 50 - FREE 50 (92-94) - FREE DELIVERY 50 (00-01)  
LIBERTY 2T 50 (97-05)-RST 2T 50 (04)-SPORT 2T 50 (06-08)-PTT EU2 50 (04-05)  
LIBERTY MOC 2T ELLE 50 (09-13) - NRG 50 / EXTREME 50 / MC3 50 (94-04)  
LIBERTY POWER DD 50 / DT 50 NRG RST MC2 50 - NTT (95-98)  
QUARTZ 50 - SFERA 50 (91-93) - SFERA RST 50 (95-97)  
VESPA ET2 50 (97-05) - ET2 INIEZIONE 50 (97-00)  
VESPA LX 2T 50 (05-13) - LX 2T TOURING / LXV 2T / LXV 2T NAVY  
VESPA PRIMAVERA 2T 50 (13-17) - VESPA S 2T COLLEGE 50 (07-12)  
VESPA SPRINT 2T NO ABS E2 50 (14-17)  
ZIP 50 (95-04) - ZIP FAST RIDER 50 / RST 50 (96-99) - ZIP 2T 50 (08-13)

**APRILIA**

MOJITO CUSTOM 2T 50 (04-10)-SCARABEO 2T 50 (10-14)-STREET 2T 50 (05-06)  
SPORT CITY ONE 2T 50 (08-11)-SR INIEZ.E CARB. 50 (14)-SR MOTARD 2T 50 (12-14)  
TUTTI MODELLI / ALL MODELS SR 2T

**GILERA**

DNA 50-EASY MOVING 50-ICE 50-RUNNER 50-RUNNER POGGIALI 50  
STALKER 50-STORM 50-TYPHOON 50



ART. **8971**

RINVIO MOTORINO AVVIAMENTO

(Sim.289202-96922R)

SCOOTER

**PIAGGIO-GILERA-APRILIA-DERBI 50 cc. 4T**

**PIAGGIO**

FLY 4T 50 (05-17) - FLY 50 4T MOT.CHIN (06-07) - LIBERTY 4T 50 (00-19)  
NRG 50 (02-11) - VESPA ET4 50 (00-05) - VESPA LX 4T 50 (05-13)  
VESPA PRIMAVERA 4T 50 (13-19) - VESPA S 4T-4V COLLEGE 50 (08-12)  
VESPA SPRINT 4T 50 (14-19)

**APRILIA**

SCARABEO 4T 50 (02-17)-RS 50 (06-10)-RS 4 50 (11-13)-RS4 2T EU4 50 (18-19)  
RS 4 REPLICA 50 (14-16) - SPORT CITY ONE 4T 50 (08-10)-SR 4T 50 (04-19)

**DERBI**

ATLANTIS 4T 50 (04-07) - BOULEVARD 4T - GPR RACING-REPLICA  
SENDA R - SENDA SM

**GILERA**

RUNNER PUREJET 50 - ST 50 (02-11)





## RINVII MOTORINO AVVIAMENTO

STARTER FREE-WHEELS



ART. **8976**

RINVIO MOTORINO AVVIAMENTO

(Sim.483539)

SCOOTER

**PIAGGIO-APRILIA-125 cc.**

**PIAGGIO**

HEXAGON LX4 125 (98-99)  
LIBERTY 125 (98-02) - LIBERTY 4T EU3 125 (06-08)  
LIBERTY 4T EU3 DELIVERY-TNT-NEXIVE 125 (08-15)  
VESPA ET4 125 (96-99)  
ZIP 125 (00-02)

**APRILIA**

MOJITO RETRO' / CUSTOM 125 (99-01)



ART. **8972**

RINVIO MOTORINO AVVIAMENTO

(Sim.82612R)

SCOOTER

**PIAGGIO-GILERA-APRILIA-DERBI 125/150/180/200 cc.**

**PIAGGIO**

BEVERLY 125 (01-10) MIC-SPORT-RST-TOURER - CARNABY 125/200 (07-10)  
FLY 125/150 (05-11) - HEXAGON GTX 125 (00) - LIBERTY 4T 125/150/200 EU3 (06-13)  
LIBERTY MOC 150 (09-13) - LIBERTY SPORT 4T 125/150/200 (06-08)  
LIBERTY PTT 125 / RST PTT 125 (05-13) - MP3 125 (06-08) - SKIPPER 4T 125 (00-02)  
SUPER HEXAGON GTX 12 125 (01-02) - VESPA ET4 125 (99-02)  
VESPA GRANTURISMO 125/200 (03-07)-GTS - GTV - GTV NAVY 125 (06-12)  
VESPA LX 125/150 (05-13) - LXV 125 (06-13) - VESPA S 4T 125/150 (07-09)  
X EVO 125 (07-16) - X7 125 (08) - X8 125/200 (05-07) - X9 125/200 (02-07)

**APRILIA**

ATLANTIC 125 (03-12) - MOJITO 125 (03-08) - SCARABEO 125 (03-06)  
SPORT CITY 125 (06-14)

**DERBI**

BOULEVARD 125/150/200 (04-10) - GP1 125 (06-08) - RAMBLA 125 (08-09)

**GILERA**

DNA 125/180 (01) - NEXUS 125 - RUNNER 4T ST 125 - VX 125 - VXR 200  
TYPHOON 4T 125



ART. **8186**

INGRANAGGIO MESSA IN MOTO  
GEAR STARTING

(Sim. Minarelli 4006590  
Yamaha 3AA 156 3100)

**MOTORI/ENGINE MINARELLI - YAMAHA**

## REGOLATORI DI TENSIONE

### VOLTAGE REGULATORS



ART. **8981**

REGOLATORE DI TENSIONE CA/CC

(Rif. Ducati 343480)

#### MOTORI MINARELLI - YAMAHA

APRILIA - MBK - MALAGUTI - BETA  
ITALJET - SUZUKI - YAMAHA

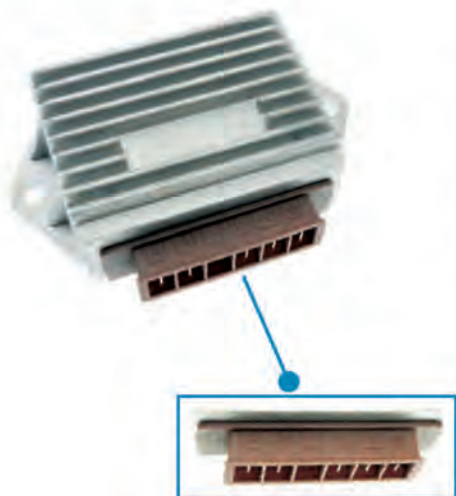

ART. **8983-E1**

REGOLATORE ELETTRONICO 12V-16A CC/CA

(Sim. 291931 ex 185824)

#### SCOOTER PIAGGIO - GILERA

SFERA - SFERA RST - ZIP - ZIP FAST RIDER - ZIP SP  
FREE - NRG - NRG MC2 - NTT - QUARTZ .... TYPHOON - STORM ....

ART. **8984-E1**

REGOLATORE DI TENSIONE

(Sim. 58096R-82587R  
294878  
AP.8124648-8127154)



#### APRILIA:

MOJITO CUSTOM 2T MOT.PIAGGIO 50 (04-10) - SCARABEO 2T 50 (2014)  
SCARABEO 2T EU2 MOT.PIAGGIO 50 (10-12) - 2T NET 50 (09-10)  
STREET 50 (05-06) SCARABEO STREET 2T RESTYLING 50 (06-09)  
SPORT CITY ONE 2T 50 (08-11) - SR INIEZIONE E CARBURATORE 50 (2014)  
SR MOTARD 2T 50 (12-14) - SR R FACTORY IE E CARBURATORE 50 (10-14)  
SR R, R FACTORY 50 (04-09)

#### GILERA:

DNA 50 (00-07) - DNA GP EXPERIENCE 50 (03-04) - ICE 50 (01-05)  
RUNNER 50 (97-00)-RUNNER POGGIALI 50 (2002) - RUNNER SP 50 (02-12)  
RUNNER SP ST & SIMONCELLI 50 (08-09) - STALKER 50 (97-11)-NAKED 50 (2008)  
STALKER SPEC.EDITION 50 (07-08)-STORM EU2 50 (2007) - TYPHOON X 50 (98-99)  
TYPHOON XR 50 (2000)-50 (01-11)-2T EU2 50(10-16)-2T EU3 CH 50 (2011)

#### PIAGGIO:

DIESIS 50 (2001)-FLY 2T 50 (05-07 / 10-11)-FREE FL 50 (95-02)-FREE DELIVERY 50 (00-01)  
HEXAGON LX4 125 (98-99)-LIBERTY 50 (97-05)-PTT EU2 50 (04-05)-2T RST 50 (2004)  
LIBERTY 2T 50 (06-08)-MOC 2T & ELLE 50 (09-13)-2T SPORT 50 (06-08)-LIB.125 (98-00)  
NRG EXTREME 50 (99-00)-RST MC2 50 (96-98)-MC3 50 (01-04)-POWER DD 50 (05-17)  
NRG POWER DD SER.SPECIALE 50 (07-12)-POWER DT 50 (06-15)-DT SER.SPECIALE 50 (07-08)  
VESPA ET2 50 (97-05) - VESPA ET4 125(96-98) - VESPA LX 2T 50(05-13)  
VESPA LX 2T TOURING & 30KM 50(10-13) - VESPA LXV 2T 50 (06-09)-LXV 2T NAVY 50 (2008)  
VESPA PRIMAVERA 2T 50 (13-17) - VESPA S 2T & COLLEGE 50 (07-12)  
VESPA SPRINT 2T NO ABS E2 50 (14-17) - ZIP RST 50 (96-99)-ZIP 50(00-04)-ZIP 2T 50 (08-13)  
ZIP SP 50 (01-04)-ZIP SP EU2 50(06-13)

APE 50 (09-17) - APE MIX 2T 50 (98-08) - APE RST MIX 50 (99-03)





## TELERETTURORI - CENTRALINE

STARTER REMOTE SWITCHES - IGNITION SYSTEM

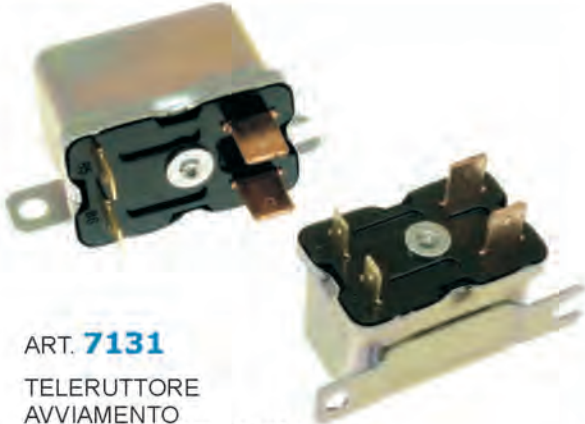

### ART. 7131

TELERUTTORE  
AVVIAMENTO  
STARTER REMOTE SWITCH

(Sim.218824)

**PIAGGIO:** SFERA 125 ('95-'97)-SKIPPER 125-150 ('94-'97)  
HEXAGON 125 - 150 ('94-'97)  
VESPA PXE ARCOBALENO 125-150-200 ('81-'97)-T5 125 ('85-'89)  
PK XL 50 ('85-'88) - PK XL RUSH 50 ('88-'89) - PK XL 125 ('86-'89)  
N 50 ('89-'90) -PK 50-125 ('82-'84) - PK 50 S 50-125 AUTOMATICA ('84-'89) - PK XL PLURIMATIC 50 ('85-'90) - FL 50 ('90)  
FL 125 ('89-'90)-FL2 HP 50 ('91-'97)-FL2 AUTOMATICA 50 ('90-'91)  
COSA 2 125-150-200 ('91-'97)-COSA CL/CLX 125-150-200 ('88-'91)  
APE TM P 50 ('85-'89) -FL - FL2 50 ('89-'95) - FL3 EUROPA 50 ('96-'99)-TM P 703/P703 V DIESEL 420('87-'01)-CAR - MAX DIESEL 420 ('86-'96)-POKER BENZINA 420 ('93)-POKER DIESEL 420 ('93-'97)  
**GILERA:** TYPHOON 125 ('95-'98)

### ART. 7130-E1

TELERUTTORE AVVIAMENTO  
STARTER REMOTE SWITCH

(Sim. 58115R)

**APRILIA:** ATLANTIC 300 (10-11) - RS4 50/125 (11-13)  
SCARABEO 2T EU2 MOT.PIAGGIO 50 (10-12)  
SCARABEO 2T NET 50 (09-10)-IE LIGHT 125 (09-10)  
SPORT CITY CUBE 125/250 (08-10)-SPORT CITY ONE 2T 50 (08-11)  
SPORT CITY ONE 4T 50 (08-10)-SPORT CITY STREET 300 (12)-SR MAX 125 (11)  
SR MAX 300 (11-13)-SR R FACTORY IE E CARB. 50 (10-12)-SR R, R FACTORY 50 (04-09)

**GILERA:** DNA 50 ('05-'07)-GSM 50 ('01)-NEXUS 125-250-300-RUNNER 50  
RUNNER SP SPEC.EDIT.50-SP ST & SIMONCELLI 50-4T ST EU3 125-VX 125-VXR 200 - STALKER 50-NAKED 50 - STALKER SPECIAL EDITION 50 - STORM EU2 50 - TYPHOON 50 - 125  
**PIAGGIO:** BEVERLY 125-250-300-CARNABY 125-200-250-300-FLY 50-100-125  
150-HEXAGON GTX 125 -LIBERTY 50-125-200 - MP3 125-250-300 - NRG 50  
QUARGO 500 - SKIPPER 125 - SUPER HEXAGON GTX 12 125  
VESPA ET2 50-ET4 125-GRANTURISMO 125-200-GT 250-GTS 125-250-300  
VESPA GTV 125-250-300-LX 2T/4T 50-LX 4T 125-LX EU3 125-150-LXV 2T 50  
VESPA LXV 4T 125-LX PRIMAVERA 125 - PRIMAVERA 2T/4T 50-125-PX 125-150  
PX 30 ANNI 125-S 2T 50-S 4T 125-150 - SPRINT 2T/4T 50-125-150  
X EVO 125-250-X7 125-250-300 X8 125-200-250-X8 PREMIUM EU2/EU3 125  
X8 STREET EU2 125-150-X9 EVOLUTION 125-250-500-ZIP 2T/4T ZIP RST  
ZIP SP EU2 50 - ZIP 125  
APE 50 ('09) - APE MIX 2T 50 ('98-'08) - PORTER D120 E5 1200 - PORTER  
MULTITECH EU4-E45 1300 - PORTER PICK DIESEL 1400 - PORTER UP-DATE 1300



### ART. 7145-E

INTERMITTENZA ELETTRONICA  
PER LAMPEGGIATORI

DEVICE FOR FLASHING INDICATOR

(Sim. 291016-292114)

SCOOTER PIAGGIO - GILERA - HONDA - PEUGEOT

APE FL2 50 ('89-'95)

### ART. 8950

CENTRALINA ELETTRONICA

IGNITION SYSTEM

(Sim.292194-Rif. Ducati 323910,11)

**PIAGGIO:** SFERA - SFERA RST - ZIP-FAST RIDER-SP  
FREE - NRG - NRG MC2 - NTT - QUARTZ

**GILERA:** TYPHOON - STORM ....



### ART. G0570

BOCCOLA BOBINA A.T. / BUSH H.T. COIL

(Sim. 114164)

SCOOTER PIAGGIO-GILERA 50 cc.

FREE 50/100-FREE DELIVERY 50-FREE FL 50-HEXAGON LX-LXT 125-LX4 125  
LIBERTY 50-LIBERTY 4T 50- PTT EU2 50-NRG 50-EXTREME 50-NRG RST MC2 50  
NTT 50-QUARTZ 50-SFERA 50-MAQUILLAGE 2 50-RST 50-VESPA ET2 50 - VESPA ET2 INIEZ.50  
ZIP 50-BIMODALE 50-ZIP FAST RAIDER 50-F.R.RST 50-RST 50 - ZIP SP 50 - TYPHOON 50

CICLOMOTORI / MOPEDS PIAGGIO

BOSS-BRAVO 3-BRAVO ERRE 2-CIAO-CIAO E1-CIAO EU2 - CIAO MIX TEEN-CIAO TRE - GRILLO-SI-SI FL2-SI MIX-SUPERBRAVO-SUPERBRAVO 3





## PIASTRINE PER VITI

### SCREWS PLATE



#### ART. 10375

PIASTRINA PER VITE AUTOFILETTANTE Ø mm. 3,5  
 PLATE FOR SELF-TAPPING SCREW Ø mm. 3,5

(Sim.CM017403)

FISSAGGIO BORDO SCUDO (ESTREMITA' INFERIORE)  
 FOR TO FIX BOARD SHIELD LOWER END

**PIAGGIO** VESPA LX - LX FL 2T/4T 50-125-150-VESPA S 2T/4T 50-125-150

APPLICAZIONI VARIE PER / VARIOUS APPLICATIONS FOR :

**PIAGGIO** BEVERLY-FLY-FREE-LYBerty-NRG-SKIPPER-X9-ZIP - PORTER

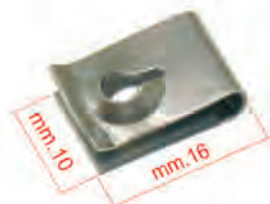

#### ART. 10376

PIASTRINA PER VITE AUTOFILETTANTE Ø mm. 4,2

(Sim.CM017410-184142)

APPLICAZIONI VARIE:

CARROZZERIA POSTERIORE - PORTE - FANALE - PLANCIA  
 BAULETTO-BATTERIA-COPERCHIO FRIZIONE-STRUMENTI  
 FIANCHETTI.....

PLATE FOR SELF-TAPPING SCREW Ø mm. 4,2

VARIOUS APPLICATIONS:

REAR BODY , DOORS - LIGHTS - TRUNK - BATTERY - CLUTCH COVER - SIDES .....

**GILERA** TYPHOON

**PIAGGIO** BEVERLY-CARNABY-FLY-FREE-HEXAGON-LIBERTY-MP3-NRG-SFERA SKIPPER  
 VESPA ET2 - ET4 - VESPA GRANTURISMO - GTS - GTV - VESPA LX - VESPA S 2T/4T - X EVO  
 X7 - X8 - X9 - ZIP - APE CALESSINO - CAR - MP 601 - POKER BENZINA/DIESEL



#### ART. 10377

PIASTRINA BRUNITA X VITE AUTOFILETTANTE Ø mm.4,2

(Sim.CM017409-185802)

APPLICAZIONI VARIE:

BATTERIA - COPRIMANUBRIO - CUPOLINO - STRUMENTAZIONI  
 FANALI POSTERIORE...)

BURNISHED PLATE FOR SELF-TAPPING SCREW Ø mm. 4,2

VARIOUS APPLICATIONS:

BATTERY - HANDLEBAR COVER - INSTRUMENTS - REAR LIGHT .....

**PIAGGIO** BEVERLY - CARNABY - FLY - LIBERTY - MP3 - NRG  
 VESPA GRANTURISMO - GTS - VESPA LX - VESPA S 2T/4T  
 X EVO - X7 - X8 - X9 EVOLUTION- ZIP 2T/4T - APE TM D LCS



#### ART. 10378

PIASTRINA PER VITE PASSO M6

(Sim. 254485)

APPLICAZIONI VARIE:

SERBATOIO OLIO - PEDALE FRENO - FANALE POSTERIORE  
 FILTRO ARIA - BATTERIA - COMMUTATORI LUCE - BOBINA -  
 BAULETTO ANTERIORE - DISPOSITIVI ELETTRICI  
 PARASPRUZZO POSTERIORE ...

PLATE FOR SCREW M6

VARIOUS APPLICATIONS:

OIL TANK - BRAKE PEDAL - REAR LIGHT - AIR FILTER BATTERY  
 LIGHTS SWITCHES - COIL - FRONT TRUNK - ELECTRICAL DEVICES  
 REAR SPLASHBOARD .....

**PIAGGIO** BEVERLY- CARNABY - DIESIS - FLY - FREE - HEXAGON - LIBERTY- MP3 - NRG - NTT  
 SFERA - SKIPPER - SKR - VESPA GRANTURISMO - VESPA LX-LXV - VESPA S 2T/4T  
 X EVO - X7 - X8 - X9 - ZIP - APE RST MIX - POKER BENZINA-TM D LCS - PORTER





# PASTIGLIE FRENO ECO-RACING

## ECO-RACING BRAKE PADS

ANT. = FRONT  
POST. = REAR



### ART. BP0091



78.7x47x7.4

<b>APRILIA</b>	ATLANTIC 500 ('02-'04) - LEONARDO 250 ('99-'01)	ANT	
	LEONARDO ST 250 ('01-'04)-LEONARDO 300 ('02-'04)	ANT	
	SCARABEO 125 (mot.piaggio) ('03->)-125 (mot.rotax) ('99-'03)	ANT	
	SCARABEO GT 125 ('99-'03)-GT 200 ('02)-SCARABEO 150 ('98-'03)	ANT	
	SCARABEO 200 ('01-'03) - 200 (mot.piaggio) ('03->)	ANT	
	SCARABEO IE 400 ('06->) IE 500 ('07->)	ANT	
	SCARABEO LIGHT 400 ('06-'08) - LIGHT 500 ('06-'08)	ANT	
	SCARABEO URBAN 400 ('06-'08) - URBAN 500 ('06-'11)	ANT	
	SCARABEO 500 ('02-'06) - CLASS 500 ('10)	ANT	
	SPORT CITY 125/200 ('04-'05) -	ANT	
	SPORT CITY CUBE 125 ('08-'10)-200('09->)-250('08-12)	ANT	
	SPORT CITY EU3 125/200 ('06-'08) - 250 ('06->)	ANT	
	RED ROSE 125 ('87-'89)	ANT	
	TUAREG RALLY 125 - 250 - TUAREG 350 - T.WIND 350	ANT	
	<b>CAGIVA</b>	BLUES 50 ('89->) - 125 ('88-93) - MITO 50 ('98-'01)	ANT
		ROADSTER 125('94->)-200('9->)-ALA AZZURRA GT 650('8->)	ANT
<b>DERBI</b>	RAMBLA 125 ('09-'11) - 250 ('09) - 300 ('10-'11)	ANT	
<b>GILERA</b>	ARIZONA HAWK 200 ('86->)-COGUAR 125('01->)	ANT	
	R1 S 125 ('88->)-RC RALLY 125-250('87->)-DAKOTA 350('86->)	ANT	
<b>HONDA</b>	CA REBEL 125('99->)-CLR CITY FLY 125('99->)-MTXR 200('87)	ANT	
<b>KTM</b>	ALL MODELS 125 ('92-'93)	ANT/POST	
	EXC 125 ('95-'02) - 125 ('03->)-EXE 125 ('00->)-LC2 125 ('98)	ANT	
<b>MALAGUTI</b>	RUNNER RALLY 125 ('87) - RUNNER YPVS 125 ('86->)	ANT	
	SPIDERMAX GT 500 GT ('04-'05) - GT EU3 500 ('06->)	ANT	
	SPIDERMAX RS 500 ('08->)	ANT	
<b>YAMAHA</b>	DT ITALIA 125 ('86-'87) - DT TENERE' ITALIA 125 ('87->)	ANT	

### ART. BP0094



36x45x6

<b>BETA</b>	EIKON 50 ('99-'03)-EIKON 125 ('00-'03)-EIKON 150 ('99-'03)	ANT/POST.
	EIKON 250 ('99->) - EVO 80 JUNIOR ('10->)-REV 80 ('00-'07)	ANT/POST.
	TECHNO 50 ('96->) - 125 ('98->) - 250 ('94-'99)	ANT/POST
	TEMPO 50 ('92-'96)	ANT
<b>CPI</b>	SUPERCROSS 50 ('03-'05)- SUPERMOTO 50 ('03-'05)	ANT/POST
<b>DERBI</b>	ATLANTIS 50 ('99->)-50-100 H20-50 WAVE ('01->)	ANT
	ATLANTIS 50-100 4T-50 BULLET ('04->)- SENDA 50 ('94->)	ANT
	SENDA R 50 ('94-'99)-SM 50 ('99->)-PREDATOR 50 ('98->)	ANT/POST.
<b>GILERA</b>	GP 50 ('02->)-GPR POGGIALI REPLICA 50 ('03->)	POST
	GSM 50 ('00->)-H@K 50 ('01->)-SUPERMOTARD 50 ('01->)	ANT/POST
<b>ITALJET</b>	TORPEDO 50('97->) -125 ('99->)-DRAGSTER 125 ('99->)	ANT
	FORMULA 50-125 ('97->)-DRAGSTER 50('98->)-TWIN 125 ('98->)	ANT/POST
<b>PEUGEOT</b>	BLASTER 50 ('09->) - BLASTER RS 12 50 ('09->)	ANT
	BLASTER 50 FURIOS ('11->)	ANT/POST
	ELYSEO 50-100-125-150('98->)-FOX 50('95->)-ZENITH 50('96->)	ANT
	LOOXOR 50 ('01->)-X FIGHT 100 ('00->)-METAL X 50 ('03->)	ANT
	LOOXOR 100-150 ('03->) SATELIS 125 4V ('06->)	POST
	SATELIS 125 ('04-'05)	ANT
<b>PIAGGIO</b>	DIESIS 50 / 100 ('01)	ANT
<b>TOMOS</b>	SE 50 ('05->) - SE 125 ('05->)	POST
<b>YAMAHA</b>	XT R 125 ('05-'11) - XT R (13D1) 125 ('07)- TY 250R ('91-'92)	ANT
	TRZ 50 ('03->)	POST





ANT. = FRONT  
POST. = REAR

## PASTIGLIE FRENO ECO-RACING

### ECO-RACING BRAKE PADS



93,9 x 36,5 x 7,6

#### ART. **BP0186**

<b>PIAGGIO</b>	BEVERLY 400 EU3 ('06-'08)-X9 500 EVOLUTION ('03-'04) X9 500 EVOLUTION ABS ('06-'07) (Sim.497396)	ANT ANT
<b>GILERA</b>	NEXUS 500 ('03-'05)-EU3 500 ('06-'11)-SP EU3 500 ('06-'07) GP 800 ('08->)	ANT ANT
<b>MBK</b>	XQ THUNDER 125 -150('01->) YP SKYLINER 125-150 ('98-'02)-180 (04->) KILIBRE 300 ('03->)	ANT ANT ANT/POST
<b>SUZUKI</b>	UH BURGMAN 125-150 ('02-'06)	ANT
<b>YAMAHA</b>	MAXTER 125-150('01-'02)-YP MAJESTY R 125('98-'01)-150 ('01->) MAJESTY 180 ('03->)-TT 600('93)-TT R(SPORTKIT)600('94-'97) VP X-CITY 125 ('08-'09) VP VERSITY 300 ('02-'04)	ANT ANT ANT ANT/POST



77 x 42 x8/95,5 x 42 x8

#### ART. **BP0195**

<b>APRILIA</b>	CLASSIC 50 ('92->) - RX50 ('92-'95) - RS 50 ('99->) MX SUPERMOTARD 50 ('02->) - PEGASO KAT 125 ('94->)	ANT ANT
<b>CPI</b>	GTR 50 -125-200-250 ('02->) - GTS 50-125-200-250 ('02-'03)	ANT
<b>GILERA</b>	DNA 50-125-180(pinza Grimeca) ('00->)-RUNNER 125-180('99) FX 125-SP 125 ('00->)-VX 4T 125-VXR 4T 125 ('01->) MAD MUD 175 ('02->)-(pinza Grimeca) 180 ('02->) RUNNER FXR-VXR 180 (pinza Grimeca) ('01->)-VXR 200 ('02->)	ANT ANT ANT ANT
<b>MALAGUTI</b>	MADISON 125-150 ('99->) - 180 ('01->) - 200 ('03->)	ANT
<b>PEUGEOT</b>	ELYSEO 125-150('01->)-ELYSTAR 125-150('03->) J.FORCE 125('03->)	ANT ANT
<b>PIAGGIO</b>	BEVERLY 4T 125 -200 (pinza Grimeca) ('02->) HEXAGON LX 125(pinza Grimeca)('98-'99)-GTX 125(p.Grim)('00->) SKIPPER LX 125 ('96-'97)-LX 2T (pinza Grimeca) 125 ('98-'99) VESPA GRANTURISMO L 125 (pinza Grimeca) ('03->) VESPA GRANTURISMO L 200 (pinza Grimeca) ('03-'05) VESPA GRANTURISMO 200 (pinza Grimeca) ('06->) VESPA GTS 250 (pinza Grimeca) ('05)	ANT/POST ANT ANT ANT ANT ANT ANT



39,8 x 51,2 x 7

#### ART. **BP0196**

APRILIA  
ATALA  
BENELLI  
BETA  
GARELLI  
GILERA  
HONDA  
ITALJET  
MALAGUTI  
MBK  
PEUGEOT  
PIAGGIO  
SUZUKI  
TOMOS  
YAMAHA







# PASTIGLIE FRENO ECO-RACING

## ECO-RACING BRAKE PADS

ANT. = FRONT  
POST. = REAR



39,8 x 53,7 2x 6,4

### ART. **BP0197**

<b>APRILIA</b>	SR ALL MODELS 50 ('93-'96)-RS 50 ('93-'98)-RX 50 ('96-'98) TUAREG HPC SYSTEM 50 ('87->)-CLASSIC 125 ('96->) AF1 125 ('87->)-AF1 EUROPA-FUTURA-REPLICA 50 ('90-'91)	ANT POST POST
<b>CAGIVA</b>	CUCCIOLO 50 ('01->) - NUVOLA 50-125 ('00->)	ANT
<b>CPI</b>	PRINCE 125 ('01->)	ANT
<b>MBK</b>	BOOSTER R 50('94->)-SPIRIT ('96-'97)-NG ('96)-TRACK('96) EVOLIS 50('92->)-80 ('94->)-FORTE 50 ('92)-MACH 50 ('02) NITRO 50 ('97)- 100 ('00->)-OVETTO 50 ('97) - 100 ('00->) DOODO 125 ('00-'01) - 150 ('01->)	ANT ANT ANT ANT
<b>TOMOS</b>	MC 50 SENJOR PRO ('04->)	ANT/POST
<b>YAMAHA</b>	AEROX LC 50 ('97) - YQ 100 ('99->) - JOG R-RR LC 50('02->) JOG Z Italia('93->)-ZEST 50 ('92)-NEO'S 50('97->)-100 ('00->)	ANT ANT



49,1 x 35 x 8,7

### ART. **BP0249**

<b>BENELLI</b>	491 50 SPORT RACING 50 ('97->)-SUPERBIKE 50 ('97->)	POST
<b>CPI</b>	GTR 50-125-200 ('02->)- GTS 50-125-200 ('02-'03)	POST
<b>GILERA</b>	FUOCO 500 ('07-'08) RUNNER FX 125 ('97-'02) FXR 180 ('98->) RUNNER PURE JET 50 ('02-'06) - PURE JET ST 50 ('08->) RUNNER SP 50 ('98-'06) - SP 125 ('99->)-SP 180 ('99->) RUNNER SP RACE 50('06->)-SP SC 50('06-'07)-SP ST 50('08->) STALKER 50 (post freno a tamburo) ('97-'04) POST.	ANT POST POST POST POST
<b>PIAGGIO</b>	LIBERTY 50 ('97-'03)-4T 50('00->)-4T 125 ('98->)-LE 4T 150('00->) LIBERTY 4T 200('06->)-SPORT 4T 200('06->)-MP3 125-250('06-'07) NRG MC2 DD 50 ('98->)-PUREJET 50 ('02-'04)-MC3 50 ('05->) SUPER HEXAGON 125 GTX (->'00)- GTX 180 (->'00) VESPA ET2 50 ('97->)-ET2 INIEZ.50 ('99)-ET2 4T 50 ('00-'01) VESPA ET4 50 ('99->) - ET4 125 /150 ('96->'02) VESPA LX 2T / 4T 50 ('05->) - LX 125-150 ('05->'06) VESPA LX EU3 125-150 ('06->'07) - LX IE EU3 125-150 ('09->'10) VESPA LX TOURING 2T 50 / TOURING 4T 4V 50 ('10->) VESPA LX TOURING 125-150 ('10->) - LXV IE 4T 125 ('10->) VESPA S 4T IE & COLLEGE 125-150 ('09->'10) ZIP 4T KAT 50-125('00->)-ZIP F.R. 50('96-'00)-ZIP RST 50('96-'00)	ANT ANT POST POST ANT ANT ANT ANT ANT ANT ANT



45,7 x 52,5 x 6,4

### ART. **BP0251**

<b>MALAGUTI</b>	F12 PHANTOM LC R 50 ('01-'05)	POST
<b>MBK</b>	NITRO 50 ('97-'03) STUN'T 50 ('99->)	POST ANT
<b>YAMAHA</b>	YQ AEROX LC 50 ('97->) SLIDER 50 ('00->)	POST ANT









# PASTIGLIE FRENO ECO-RACING

## ECO-RACING BRAKE PADS

**ANT. = FRONT**  
**POST. = REAR**



### ART. **BP0259**



99,8 x 29,1 x 9

<b>MBK</b>	YP SKYLINER 250 ('00-'03) - YP SKYLINER 400 ('04->)	POST
<b>YAMAHA</b>	MAJESTY YP 250 ('00-'03) - MAJESTY YP ABS 250 ('03->)	POST
	MAJESTY YP DX 250 ('98-'99) - X-CITY VP 250 ('07-'13)	POST
	X-MAX YP R ABS 125 ('11->) X-MAX YP R 250 ('05-'09) ('10-'13)	POST
	X-MAX YP R 250 - X-MAX YP R 400 ('13-'15)	POST
	X-MAX YP RA ABS 125 ('13-'14) - MAX YP RA ABS 250 ('11-'14)	POST
	X-MAX YP RA ABS 400 ('14-'15)	POST
	X-MAX BLACK YP R 250 ('09->) - X-MAX SPORT YP R 250 ('11-'12)	POST
	X-MAX MOMODESIGN YP RA ABS 400 ('14->)	POST
	X-MAX MOMODESIGN YP R 400 ('14->)	POST
	CELLOW 225 ('97->) - CRYPTON 105 T ('98->) - DT 175 ('00->)	ANT
	RZ (5FC1/2) 50 ('02->) - ST BRONCO 225 ('97->)	ANT
	TW 125 ('99-'02) - TW R / S 125 ('03-'04) - TW 200 ('01-'02)	ANT
	TW (5VC1/2) 225 ('03->) V SPORTY 110 ('96->) -	ANT
	XG TRICKER 250 ('04-'06) - XT 225 ('01-'06) - XT X 250 ('06-'08)	ANT
	YZ-F R 6 600 ('99-'02) - YZ-F R1 1000 ('02-'03)	POST



31,7 x 51,1 x 6

### ART. **BP0266**

<b>PIAGGIO</b>	VESPA PX 125-150-200 ARCOBALENO ('98->)	ANT
----------------	---	-----

### ART. **BP0267**



51,1 x 53,5 x 9,5

<b>APRILIA</b>	SCARABEO 50 DITECH ('01-'04)-100 4T ('01-'04)-125 -150 ('98->)	POST
	SCARABEO 125-200 (MOT.PIAG.)('03)-250 ('04-'06)-500 ('02-'06)	POST
	SR 50 2000 ('00->)-SR 50 I E DITECH ('02->)-SR 50 R	POST
	ATLANTIC 125-200-250 (pinza Grimeca) ('03->'05)- 500 (pinza SX)	POST
	ATLANTIC 500 SPRINT ('05->)-LEONARDO 250 ('99->)-300 ('02->)	POST
	SPORT CITY 125/200 ('04-'05) SPORT CITY Eu3 125/200('06-'08)	POST
	SPORT CITY - Eu3 250 ('06->) - 250 ('08-'12)	POST
	SPORT CITY CUBE 125 ('08-'10) - 200 ('09->)	POST
	SPORT CITY CUBE 300 ('08->) - CITY STREET 125/300 ('12->)	POST
<b>BETA</b>	EIKON 125-150 ('99->) - EIKON 125-150 ('04->)	POST
<b>DERBI</b>	RAMBLA 125 ('09-'11) - 250 ('09->) - 300 ('10-'11)	POST
<b>MALAGUTI</b>	F12 125-200 MAX ('02->)-F18 125-150 WARRIOR ('01->)	POST
	MADISON 125-150('99-'02)-180('01->)-200 all models-250 ('99->)	POST
	400 ('02->)-400 RESTYLING ('03->)	POST
	PHANTOM MAX 125-200('03->)-250('04->)-PASSWORD 250 ('05)	POST





ANT. = FRONT  
POST. = REAR

## PASTIGLIE FRENO ECO-RACING ECO-RACING BRAKE PADS



64 x 37,6 x 10,9  
85 x 43 x 8,5

### ART. BP0269

<b>KYMCO</b>	AGILITY R 16 2T 50 ('10->) - R 16 4T 50 ('08->) - R 16 125 ('08-'12)	ANT
	AGILITY R 16 150 ('08->) - AGILITY R 16 200i ('09-'11)	ANT
	PEOPLE 50 ('99-'00)-50 EU2 ('03-'04) - 125 ('99-'00)-125 EU2 ('03-'04)	ANT
	PEOPLE 125 EU3 ('07->)-125 ONE I ('14->)-150 ('99-'06)	
<b>ANT</b>	PEOPLE EU3 ('07-'08) - PEOPLE	ANT
	PEOPLE S 50 ('05-'08) - S 50 4T ('06-'08) - S 125 ('05-'06)	ANT
	PEOPLE S 125 DD ('07-'08) - S 200 ('05-'06) - S 200 I ('07->)	ANT
	SUPER 8 125 ('08-'09)	ANT
	SUPER 9 AC - LC 50 ('02->) - SUPER 9 SPORT Eu2 50 ('03-'04)	POST
	SUPER 9 125 ('00-'01) - SUPER 9 200 ('00->)	POST
<b>HONDA</b>	CRM 50 ('93->) - CRE 125 ('96-'02) - CR 125 ('95-'01) - 250 ('02->)	ANT
	NX DOMINATOR 250 ('93->) - SUPERMOTARD 125 - 250 ('00->)	ANT
	XLR 125 ('93->) - 250 ('91->) - XL DEGREE 250 ('91)	ANT



117,5 x 41,5 x 8,6

### ART. BP0282

<b>APRILIA</b>	ARECIFE 125 (Spagna) ('03-'06) - AREFICE 200 (Spagna) ('03->)	ANT
	ATLANTIC 125 - 200 - 250 (pinza Grimega) ('03-'05)	ANT
	ATLANTIC 300 ('10-'11) - IE 250 ('07->) - SPRINT 500 ('05-'08)	ANT
	SCARABEO 125 ('04-'06) - 200 ('07->) - 250 ('04-'06)	ANT
	SCARABEO EU3 125 ('06-'07) - SCARABEO IE 250 ('06-'09)	ANT
	SCARABEO CLASS 200 ('10) - SCARABEO GT 125 ('04->)	ANT
	SCARABEO LIGHT 125 ('07-'08) - LIGHT 250 ('06-'08)	ANT
	SCARABEO LIGHT 300 ('06-'10) - LIGHT IE 125 ('08-'10)	ANT
	SCARABEO LIGHT IE 200 ('12->) - SPECIAL IE 300 ('09->)	ANT
	SPORT CITY CUBE 300 CUBE ('08->)	ANT
	<b>KYMCO</b>	K-XCT I 125 ('14->) - K-XCT ABS I 300 ('12-'14)
PEOPLE GTI ABS 300 ('12->)		ANT
<b>MALAGUTI</b>	MADISON S 250 ('99-'01)-K 400 ('02->)-K 400 RESTYLING ('02-'04)	ANT
<b>PEUGEOT</b>	LOOXOR 150 ('02-'03)	ANT
<b>PIAGGIO</b>	BEVERLY SPORT TOURING IE 350 ('12->)	ANT



55,5 x 49 x 7,5

### ART. BP0298

<b>BENELLI</b>	ADIVA 125-150 ('00-'02)	POST
<b>DERBI</b>	GP1 50 ('05->)	POST
<b>GILERA</b>	DNA 50 - 125 - ('00->) - 180 ('01->)	POST
	RUNNER VX/VXR 4T 125 ('01-'04)-125-180 (pinza Heng Tong) ('02->)	POST
	125 4T ('05-'06)-VX 4T 125 ('06->)-VX SC 4T 125 ('06-'07)	POST
	VX 4T 200 ('02->)-VXR 4T 200 ('05-'06)-VXR RACE 4T 200 ('06->)	POST
<b>PIAGGIO</b>	SUPER HEXAGON GTX 125-180-250 ('01->)	POST
	SUPER HEXAGON GTX 125-180-250 (pinza Grimeza-H.Tong) ('03->)	POST
	VESPA GRANTURISMO L 125 (pinza Grimeca / Heng Tong) ('03 >)	POST
	VESPA GRANTURISMO L 200 (pinza Grimeca / Heng Tong) ('03-'05)	POST
	VESPA GRANTURISMO 200 (pinza Grimeca / Heng Tong) ('06->)	POST
	VESPA GTS 250 (pinza Grimeca / Heng Tong) ('05->)	POST
	VESPA GTS IE 300 ('12->)	POST
	VESPA GTS SUPER 300 ('08->)- GTS SUPER SPORT 300 ('11->)	POST
	VESPA GTV 250 ('06->) - GTV IE 300 ('11->)	POST





**PASTIGLIE FRENO ECO-RACING**  
ECO-RACING BRAKE PADS

**ANT. = FRONT**  
**POST. = REAR**



81 x 42 x 9,3

ART. **BP0304**

<b>HONDA</b>	@ NES 125 / 150 (tamburo post/rear drum) ('00)	ANT
	CH SPACY 125 ('94)	ANT
	DYLAN 125 ('01->) - DYLAN SES 150 ('01)	ANT
	LEAD NH 100 ('00->) - LEAD SCV 110 ('08-'09)	ANT
	NHX 110 ('08-'09)	ANT
	PSi 125 / 150 ('06->)	ANT
	SH 125 / 150 (tamburo post/rear drum) ('00-'08)	ANT
<b>KAWASAKI</b>	EPSILON 250 ('03->)	POST
<b>SUZUKI</b>	AN BURGMAN 250 ('96->)	POST



44,5 x 51 x 7

ART. **BP0327**

<b>KYMCO</b>	GRAND DINK 250 ('01-'02) - GRAN DINK EU2 250 ('03-'04)	ANT
<b>KYMCO ATV</b>	MXU 250 ('05->)	POST
<b>SYM</b>	GT 500 ('07->) - GTS 125 ('07->) - GTS 250 ('07-'08)	ANT
	JOYMAX 250 ('05-'07)	ANT
	JOYMAX EU3 I 250 ('07-'08)	ANT
	JOYMAX EVO 300 ('09->)	ANT
	JOYMAX EVO I 300 ('10)	ANT
	JOYMAX I 300 ('12->)	ANT
	VOYAGER 125 / 250 ('05)	ANT



ANT. = FRONT  
POST. = REAR

## PASTIGLIE FRENO ECO-RACING

### ECO-RACING BRAKE PADS

#### ART. **BP0330**



97 x 41 x 9



77 x 41 x 9

<b>APRILIA</b>	SPORT CITY 50 ONE 2T ('08-'10) - 50/125 ONE 4T EU3 ('08-10) SR 125 MAX ('12) - SR 300 MAX ('10->) SR 125 SPORT CITY ONE ('12->)	ANT ANT/POST ANT
<b>GILERA</b>	DNA 50 ('05-'07) - DNA 50 GP EXPERIENCE ('03-'04) FUOCO 500 ('07-'08) - GP 800 ('08->) NEXUS 125 EU3 ('07->) - NEXUS 125 IE EU3 ('08-'11) NEXUS 250 EU3 ('06->)-250 SP EU3 ('06-'07)-300 EU3 ('08-'11) RUNNER 50 - 125 - 180 - 200 - 300	ANT POST ANT/POST ANT/POST ANT
<b>PEUGEOT</b>	ACTIVE 125 ('13->)-CITY STAR 50 ('14->)-CITY STAR 125('11->) CITY STAR 200('13->)-GEOPOLIS 125 ('07->)-GEOP.RS 125('10->) SATELIS 250 ('06->)	ANT ANT ANT/POST
<b>PIAGGIO</b>	BEVERLY 125-200 (PINZA HENG TONG)('01->) - EU3 125/250 BEVERLY MIC 125/250 EU3 ('07->)- SPORT EU3 125/250 BEVERLY TOURER EU3 125 / 250 / 300 BEVERLY RST125-RST 250-RST 4T 4V IE EU3 BEVERLY CRUISER 250-LEADER 250- BEVERLY SPORT TOUR.4T 4V IE EU3 350 BEVERLY 400 EU3 ('06-'08) CARNABY 125/200 ('07-'10) - 250 ('08->) - CRUISER 300 ('09->) FLY 50 2T / 4T - FLY 100 4T- FLY 125/150- FLY 150 EU3 HEXAGON GTX 125 4T ('01->) - GTX 180 4T ('01->) MP3 YOURBAN ERL 125-BUSINESS LT ABS 300/500 MP3 SPORT ABS 300- 400 - IE LT/IE LT SPORT 400 MP3 TOURING IE LT 400 - LT 400 - MIC 400-TOURING RL 400 MP3 SPORT LT-BUSINESS 500 -SPORT RL 500 - ABS 500 VESPA GRANTURISMO 125/200 (PINZA HENG TONG) ('03->) VESPA GTS 250 (PINZA HENG TONG) ('05->) - GTS IE 300 ('12) VESPA GTS SUPER 300 ('08->) - SUPER SPORT 300 ('11->) VESPA GTV 250 ('06->) - GTV IE 300 ('11->) V.PRIMAVERA 2T/4T 4V('13->)125 4T 3V IE-150 4T 3V('13-'14) VESPA SPRINT 2T/4T 4V ('14->) - X EVO 125-250 ('07-'12) X EVO EU3 400 ('07-'11) - X10 4T 4V IE 350/500 ('12->) X7 125 ('07-'09) - X10 4T 4V IE 125 ('12->) X7 125 EU3 125 ('08-'09) X7 EVO IE EU3 125('09-'10)-X7 EU3 250-X7 EVO IE 300('11->) X8 125-200 ('04) - X8 125-200 (PINZA HENG TONG)('05->) X8 PREMIUM EU2 125 - STREET EU3 125/150 ('06->) X8 250 ('05->) X8 400 (PINZA DX)('06->) - X8 EU3 400 ('06-'08) X9 125 EVOLUTION (PINZA SX HENG TONG) ('01->) X9 250 EVOLUTION (PINZA DX) ('04-'06)	ANT/POST. ANT/POST ANT/POST ANT/POST ANT POST ANT/POST ANT ANT POST POST POST POST ANT ANT ANT ANT ANT ANT ANT ANT ANT/POST POST ANT/POST ANT ANT ANT ANT ANT/POST ANT ANT

#### CON SEGNALE D'USURA WITH USURY INDICATOR



#### ART. **BP0343**

SERIE COMPOSTA DA 4 PZ.

<b>MICROCAR</b>	<b>PIAGGIO</b>	LIGIER NOVA 500 ('00->)	ANT
	<b>PIAGGIO</b>	M 500 ('06-'08)	ANT
	<b>PIAGGIO</b>	PK 500 ('06-'08)	ANT
<b>MICROCAR GRECAV</b>		EIKE 505	ANT





# PASTIGLIE FRENO ECO-RACING

ECO-RACING BRAKE PADS

ANT. = FRONT  
POST. = REAR



100 x 39 x 12

ART. **BP0378**

<b>MBK</b>	YP SKYLINER 400 ('04->)	POST
<b>YAMAHA</b>	MAJESTY YP 400 ('04-'11)	POST
	MAJESTY YP ABS 400 ('07-'11)	POST
	T MAX XP 500 ('04-'11)	POST
	T MAX XP ABS 500 ('05-'11)	POST
	T MAX SV XP 500 ('11->)	POST
	T MAX SV XP ABS 500 ('11->)	POST



117,9 x 45,4 x 9

ART. **BP0400**

<b>HONDA</b>	@ NES 125 / 150 ('09->)	ANT
	FORZA NSS 300 ('14->)	ANT
	FORZA NSS X 250 ('05->) - FORZA NSS XE 250 ('05->)	ANT
	JAZZ 250 ('05->) - NSS 250 ('05->) - PS 250 ('05->)	ANT
	S-WING FES 125 ('08->) - S-WING FES 150 ('07->)	ANT
	SH 125i / 150i ('09-'12) - SH 300i ('07->)	ANT
	CB HORNET 600 ('07->)	ANT
	VFR CROSSTOURER LE 1200 ('12->)	ANT
	VFR XC CROSSTOURER 1200 ('12->)	ANT
	VFR XDC CROSSTOURER 1200 (w/DCT) ('12->)	ANT
<b>SUZUKI</b>	BURGMAN AN 125 ('07-'13) - BURGMAN UH 200 ('07-'13)	ANT
	SIXTEEN UX 125 / 150 ('08-'11)	ANT



81,7 x 37,9 x 9,5

ART. **BP0401**

<b>HONDA</b>	@ NES 125 / 150 ('09->)	POST
	FORZA 125 ('15->) - FORZA NSS 300 ('14->)	POST
	FORZA NSS X 250 ('05->) - FORZA NSS XE 250 ('05->)	POST
	JAZZ 250 ('05->) - NSS 250 ('05->)	POST
	S-WING FES 125 ('08->) - S-WING FES 150 ('07->)	POST
	SH 125 / 150 ('13->)	POST
	SH 125i / 150i ('09-'12) - SH 300i ('06->) - SH ABS 300i ('06->)	POST

ANT. = FRONT  
POST. = REAR

## DISCO FRENO

BRAKE DISC

### ART. D1001-R



Ø esterno/outside mm. 190  
Ø interno/inside mm. 58  
spessore/thickness mm. 3,5

<b>APRILIA</b>	AREA 51 50	POST
	HABANA 50-125	ANT
	RALLY 50	ANT/POST
	SR 50/125//150 - SR SPORT PRO 50	ANT
	SCARABEO 50 BRIGHT-50DD-50 DELUXE SCARABEO 50 DITECH-50 DT - SR 50 - GULLIVER 50	POST POST
<b>ATALA</b>	HACKER 50 - SKEGGIA 50	ANT
<b>BENELLI</b>	491 50	ANT/POST
	K2 50-100 - NAKED 50-100- QUATTRO MOVE X50	ANT
<b>BETA</b>	ARK 50	ANT/POST
	CHRONO 50	ANT
	EIKON 50	ANT/POST
	EICON 125/150	POST
	QUADRA 50 - TEMPO 50	ANT
<b>CPI</b>	ARAGON 50 - FORMULA 50 - HUSSAR 50	ANT
	OLIVER 50-125	ANT
	POPCORN 50	ANT
<b>GILERA</b>	STALKER 50 - STORM 50	ANT
	TYPHOON 50 - 80 - 125	ANT
<b>ITALJET</b>	DRAGSTER 50	POST
<b>HONDA</b>	BALI 50-100-125 -	ANT
	SKY 50 - SHADOW 50 - 90 - SPACY 125	ANT
	YUPI 90	ANT
<b>MALAGUTI</b>	CROSSER 50	ANT
	F12 PHANTOOM 50-KAT 50	ANT/POST
	F15 FIRE FOX 50	ANT
	F15 FIRE FOX-CIAK TWIN DISK 50	POST
<b>MBK</b>	BOOSTER NG 50 ('99->) - OVETTO 50-100	ANT
	NITRO 50-100	ANT/POST
	SLIDER-STUNT	ANT
<b>PEUGEOT</b>	BUXY 50 - ELYSEO 50 - LUDIX ELEGANCE 50 - METAL X	ANT
	LOOXOR 50-100 - JET C-TECH 50 - JET FORCE 50 -	POST
	SPEEDAKE 50 - SQUAB 50 - SV 50-80-100-125	ANT
	TREKKER 50-100 - VIVACITY 50-100	ANT
	VIVACITY 100	POST
<b>PIAGGIO</b>	NRG 50 - NRG MC2 50 - NTT 50	ANT
<b>YAMAHA</b>	AEROX 50-100	ANT/POST
	BW'S NG 50 ('99->) - JOG R 50 - JOG RR 50	ANT
	NEO'S 50-100 - SLIDER 50	ANT





## GANASCE FRENO BRAKE SHOES

ANT. = FRONT  
POST. = REAR

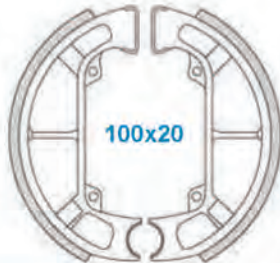

100x20

### ART. GF0252

<b>GILERA</b>	EASY MOVING 50	('95->)	POST
	STORM 50	('94->)	POST
	TYPHOON 50	('93->)	POST
<b>PIAGGIO</b>	FREE 50 (ruote in lega)	('96->)	POST
	NRG 50	('94-'95)	POST
	NTT 50	('->'95)	POST
	QUARTZ 50	('92->)	POST
	SFERA 50	('91->)	POST
	SFERA 80 ZIP 50	('94->) ('92-'93)	POST POST

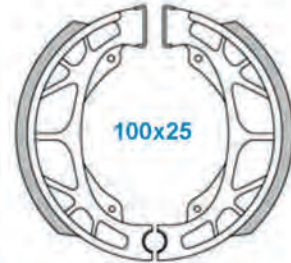

100x25

### ART. GF0255

<b>APRILIA</b>	AMICO 50	('90-'91)	ANT/POST
	AMICO 50 all models	('92->)	POST
	GULLIVER 50 - RALLY 50	('95->)	POST
	SCARABEO 50-70	('94-'96)	POST
	SONIC SPICE 50-SONIC-GP 50 SR 50 all models	('97->) ('93-'96)	POST POST
<b>BETA</b>	CH 50 ('92-'94)-CHRONO 50	('92->)	POST
	502 50	('97->)	POST
	QUADRA 50	('95->)	POST
	TEMPO 50		POST
<b>CAGIVA</b>	CITY 50	('92->)	POST
<b>KTM</b>	CHRONO 50 SCOOTER	('94->)	POST
	GO 50 SCOOTER	('94->)	POST
<b>MALAGUTI</b>	CENTRO 50	('->'92)	POST
	CENTRO 50 SL	('93->)	POST
	CIAK 50	('99->)	POST
	F10 50	('92-'93)	POST
	F10 50 all models	('94->)	POST
	F10 TIMERMACHINE 50 -WAP50	('02->)	POST
	F12 PHANTOM 50	('94->)	POST
	F12 PH.liquid cooled 50	('95-'97)	POST
	F15 FIRE FOX 50 YESTERDAY 50	('96-'97) ('98->)	POST POST
<b>PEUGEOT</b>	SV 50T (forcella telescopica)	('93->)	POST
<b>SYM</b>	CINDERELLA 50 - 100	('99->)	POST
	CITY HOPPER 50	('99->)	POST
	FANCY 50-SUPER FANCY 50/100	('95->)	POST
	FIDDLE 50 - RED DEVIL 50	('99->)	POST
	JUNGLE 50	('96->)	POST
	MASK 50-LC 50 SUPER DUKE 125	('00->) ('99->)	POST POST
<b>YAMAHA</b>	TRUNK 50 - AXIS PROFOOT 50	('94->)	POST
	YA AXIS 50	('93->)	POST
	JOG 50 - JOG 50 Z (Italia)	('93->)	POST



104x20

### ART. GF0257

<b>PIAGGIO</b>	FREE 50	('93-'96)	POST
	FREE 50 (ruote in lega)	('96->)	ANT
	ZIP 50	('92-'93)	ANT



100x20

### ART. GF0263

<b>GILERA</b>	TYPHOON 50	('96->)	POST.
<b>PIAGGIO</b>	FREE 50	('96->)	POST.
	NRG 50 MC2	('96->)	POST.
	NRG 50	('96->)	POST.
	NTT 50	('96->)	POST.
	SFERA RST 50	('95->)	POST.
	ZIP FAST RIDER 50	('93-'95)	POST.





## GANASCE FRENO BRAKE SHOES



ANT. = FRONT  
POST. = REAR

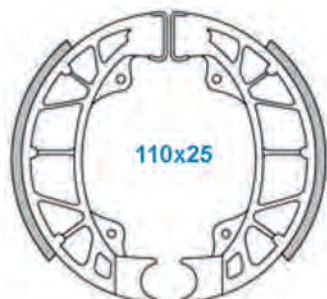

110x25

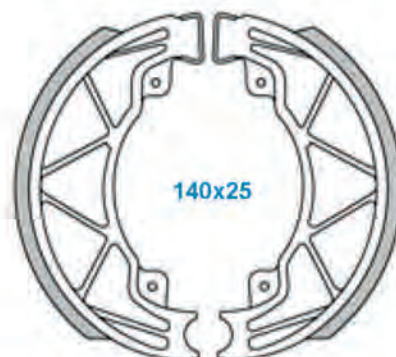

140x25

### ART. GF0261

<b>APRILIA</b>	SPORT CITY 50 ONE 2T-4T	('08->'10)	POST
<b>GILERA</b>	RUNNER 50	('96->)	POST
	STALKER 50	('05->'08)	POST
	STALKER 50 (POST.F.D)	('97->'04)	POST
	STALKER NAKED 50	('08->)	POST
	STALKER SPECIAL EDIT. 50	('07-'08)	POST
	STORM EU2 50	('07->)	POST
	TYPHOON 125	('95->'98)	POST
	TYPHOON X-XR 125	('99->'00)	POST
<b>PIAGGIO</b>	HEXAGON 125	('94->'97)	POST
	HEXAGON 150	('94->'99)	POST
	HEXAGON LX 150	('98->)	POST
	SFERA 125	('95->)	POST
	SFERA 4T 125	('95->'97)	POST
	SKIPPER 125-150	('93->'99)	POST
	VELOFAX 50	('96->)	ANT
	VESPA ET2 / ET4 50	('97->)	POST
	VESPA ET2 INIEZIONE 50	('99)	POST
	VESPA ET2 4T 50	('00-'01)	POST
	VESPA ET4 125 /150	('96->'02)	POST
	VESPA LX 2T / 4T 50	('05->)	POST
	VESPA LX 125-150	('05->'06)	POST
	VESPA LX EU3 125-150	('06->'07)	POST
	VESPA LX IE EU3 125-150	('09->'10)	POST
	VESPA LX TOURING 2T/4T 4V 50	('10->)	POST
	VESPA LX TOURING 125-150	('10->)	POST
	VESPA LXV IE 4T 125	('10->)	POST
	VESPA PRIMAVERA 2T 50	('13->)	POST
	VESPA PRIMAVERA 4T 4V 50	('13)	POST
	VESPA PRIM.4T 3V IE 125 /150	('13-'14)	POST
	VESPA SPRINT 2T 50/4T 4V 50	('14->)	POST
	VESPA S 4T IE & COLLEGE 125-150	('09->'10)	POST
	ZIP SP 50	('96->)	POST
	ZIP RST 50	('96->'97)	POST
	ZIP 50	('99->)	POST
	ZIP 125 4T	('00->'02)	POST

### ART. GF0268

<b>APRILIA</b>	HABANA 125	('98->)	POST
	MOJTO 125 all models	('99->'04)	POST
	SCARABEO 2T/4T 4V 50	('10->'12)	POST
	SCARABEO 4T 100	('01->'04)	POST
	SCARABEO 4T RST	('06->'12)	POST
	SPORT CITY ONE 4T EU3 125	('08->'10)	POST
	SR 125 - 150	('99->)	POST
<b>DERBI</b>	BOULEVARD 125-150	('02->'04)	POST
	BOULEVARD 200	('05->)	POST
<b>GILERA</b>	RUNNER 125	('97->'99)	POST
	RUNNER 180	('97->'98)	POST
<b>MALAGUTI</b>	CENTRO 50 4T	('08->)	POST
	CENTRO 50 SL 4T	('10->)	POST
	CIAK MASTER 4T 50	('05->'06)	POST
<b>PIAGGIO</b>	FLY 2T 50	('05->)	POST
	FLY 4T 100	('06->'08)	POST
	FLY 125	('05->'08)	POST
	FLY 150	('05->'07)	POST
	FLY EU3 150	('08-'10)	POST
	FREE 100	('01->)	POST
	HEXAGON LX 125-180	('98->)	POST
	LIBERTY 2T 50	('97->)	POST
	LIBERTY 4T 50	('00->'01)	POST
	LIBERTY 125	('98-'02)	POST
	LIBERTY RST 125-200	('04-'05)	POST
	LIBERTY RST PTT 125	('05-'11)	POST
	LIBERTY 4T 125	('06->'07)	POST
	LIBERTY 4T EU3 125-200	('07-'08)	POST
	LIBERTY LE 150	('00->'02)	POST
	LIBERTY 4T 150	('08)	POST
	LIBERTY 200	('06->)	POST
	LIBERTY SPORT 125-200	('06->)	POST
	LIBERTY SPORT 4T	('06-'08)	POST
	LIBERTYSPORT EU3 125	('06-'08)	POST
	LIBERTY SPORT 4T 150	('08->)	POST
	LIB.SPORT 4T EU3 200	('06-'07)	POST
	SKIPPER 4T 125	('98->)	POST
	SKIPPER 4T 150	('00->'02)	POST
	X8 STREET EU3 125-150	('06->)	POST







## GANASCE FRENO BRAKE SHOES

ANT. = FRONT  
POST. = REAR

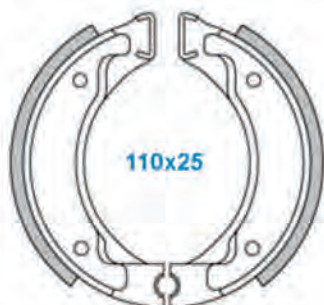

### ART. GF1187

<b>MBK</b>	ACTIVE 50 ('90->) - ACTIVE 75-80 ('90->) BOOSTER 50 (->'94) BOOSTER R 50 ('94->) - SPIRIT 50 ('96->)-TRACK 50 ('96->) FIZZ 50 ('94->) - FLIPPER 50 ('98->)-FORTE 50 ('95->)	ANT ANT/POST POST POST
<b>YAMAHA</b>	BELUGA 50-80 ('90->) BW 50 ('91->)-BWS 50 ('92-'94)-GRAFIX 50 ('93->)-TRAFFIC 50 ('93->) JOC 50 ('90->)-V 50M ('83->)-T TOWNMATE 80 ('82->)-V80 ('83->) BW NEXT GENERATION 50 ('96->)-BUMP 50 ('97->)-SPY 50 ('00->) BW SPORTS SPEC R 50 ('02->)-BWS R 50 ('95->)-ZUMA 50 ('96->) CY JOG 50 ('90->)-DT R 50('93->)-MINI L SHFT 50 ('83->)-WHY 50('97->) YM BREEZE 50 ('94->)-PW 80 ('91->)-CRYPTON 100 ('98->)	ANT ANT/POST ANT/POST POST POST POST POST
<b>YAMAHA ATV</b>	YS 60S (MOTO4) ('86->)-YT 60 L7N TRI ZINGER ('84-'85) YFM 80 T/U ('87-'88) - YFM 100 T7U CHAMP ('87-'88)	POST ANT

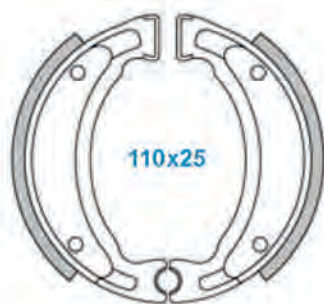

### ART. GF1200

<b>CPI</b>	BABY J 50 ('02->)-HUSSAR 50('01-'05)-MARS 50 ('01-'02) OLIVER 50 all models ('03-'05)-POPCORN 50 ('02->)	POST. POST.
<b>FANTIC</b>	PONY SR 50 ('93->)-QUEENIE 50 ('95->) PONY 50 ('93->)	POST. ANT/POST
<b>ITALJET</b>	ADLY 50 ('90->)	POST
<b>MALAGUTI</b>	F10 AC 50 ('08->)-F10 AC ECO 50('09->'10)-F12 PHANTOM AC 50 ('07-'10)	POST
<b>MBK</b>	BOOSTER NEXT GENERATION 50 ('96->)-CRZ TARGET 50 ('91-'95) CS MACH G 50 ('02->)-EVOLIS 50 ('92->)-EVOLIS 80 ('94->) OVETTO 50 ('97->)-ROCKET 50 ('96->)-STUN'T 50 ('00->) X-LIMIT 50 ('98->)-FLAME 125 ('98->)-FLAME R 125 ('98->) SORRISO 50 ('92->)	POST POST POST POST ANT/POST
<b>YAMAHA</b>	BW SPY 50 ('95-'99)-CR TARGET 50 ('91->)-CR Z 50 ('92->)-DTR 50 ('98-'03) YE ZEST 50 ('92->)-YN NEO'S 50 ('97->)-YSR 50-60 ('86->)-TY 80 ('83->) YSR 80 ('86->)-CR TARGET 90 ('91->)-YB 100 ('82->)-SR SE 125 ('82-'92) TT-R LW 125 ('00->)-TW 125 ('98->)-TW 200 ('87-'01) XC TR CYGNUS R 125 ('96->)-XC CYGNUS R 125 ('96-'03) XC K CYGNUS R 125 ('97-'98)-XCT R ('95-'98)- XC CYGNUS GT 150 ('90-'95)-SC FLY ONE 150 ('97-'98) YZ 1-K 100 ('82->) CT SUPER SPORT 50('90->)-BELUGA 80(->'89)-TT-R 90('00->) TT-R 125 ('00->)	POST POST POST POST POST POST POST ANT ANT/POST ANT/POST
<b>YAMAHA ATV</b>	YFM BADGER 80 ('92-'01)-YFM T/U CHAMP 100 ('87->) YFM W/A/B CHAMP ('89-'91)-YFA 1 BREEZE 125 ('89-'02) YFM 200 all models (MOTO 4) ('85-'89)-YFS BLASTER 200 ('88-'01) YT J/K (TRI MOTO) 175 ('82-'83)-YTM 200 all models (TRI MOTO)('83-'85) YFM S/T/U (MOTO 4) 225 ('86-'88)-YTM 225 all models (TRI MOTO)('82-'86) YFB D/E/F TIMBERWOLF 250 ('92-'94)-YFM ERT/EUR 350 ('87-'88)	ANT ANT ANT ANT ANT ANT

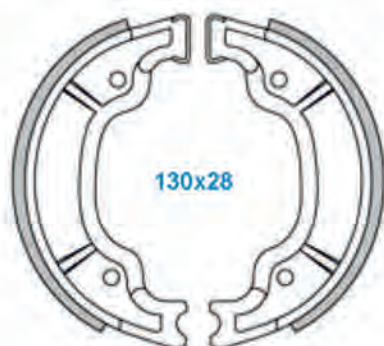

### ART. GF1303

<b>APRILIA</b>	SCARABEO 100 (MOTORE YAMAHA) ('00->)	POST
<b>MBK</b>	DODO 50 ('00->) - XN DODO 125 ('00-'01) - XN DODO 150 ('01->) YW BOOSTER 100 ('99->) - YP SKYLINER 125 - 150 ('98-'01)	POST POST
<b>YAMAHA</b>	BWS 100 ('00->) - BL BELUGA 125 ('93->) - RIVA XX 125 ('93->) XC T CYGNUS R 125 ('95-'98) XVS DRAG STAR 125 ('00->)-XVS 250 ('01->)-YBR 125 ('05->) YP MAJESTY 125 ('98-'00) - 150 ('00->)-YP E MAJESTY 180 (->'03) RT 180 ('93-'94)-RT G,H 180 ('95->) - XV S VIRAGO 250 ('95->) SRV SOULFUTWIN RENAISSA 250 ('96->)	POST ANT POST POST POST POST
<b>YAMAHA ATV</b>	YFM BADGER 80 ('92-'01)-YFA 1 BREEZE 125 ('92-'02) YFM 200 all models (MOTO 4) ('85-'89)	POST POST



# HIGH QUALITY

## TRASMISSIONI FRENO posteriore REAR BRAKE TRANSMISSIONS

### ART. 8400

TRASMISSIONE FRENO POSTERIORE  
REAR BRAKE TRANSMISSION

(Sim.564217)

#### PIAGGIO:

FLY 125 - 150 ('05-'07) - LIBERTY 4T RST 50 ('04) - LIBERTY 125 ('01-'02) - LIBERTY RST 125 ('04-'05)-LIBERTY RST 200 ('04)  
NRG POWER DT 50('06-'15) - NRG POWER DT SR.SPECIALE 50 ('07-'08)  
VESPA ET4 50 ('00-'05) - VESPA ET4 125 ('99-'02) - VESPA LX 4T 50('05-'09) - LX 4T 4V 50 ('09-'13) VESPA LX 4T 4V TOURING 50 ('10-'13)  
VESPA LX 125/150('05-'06)-LX EU3 125/150('06-'08) - VESPA LX FL 4T 125/150 (2009) - VESPA LX 4T EU3 TOURING 125 ('10-'11)  
VESPA LX EU3 IE 125/150 ('09-'11) - VESPA LX TOURING 150 ('10-'12) - VESPA S 4T EU3 125 ('07-'08) - S 4T 150 ('08-'09)  
VESPA S 4T 4V & COLLEGE 50 ('08-'12) - VESPA S 4T IE & COLLEGE 125 ('09-'11)-150('09-'12)



### ART. 8414

TRASMISSIONE FRENO POSTERIORE  
REAR BRAKE TRANSMISSION

(Sim.560006)

#### PIAGGIO:

FREE FL 50('95-'02) - DELIVERY50 ('00-'01) - FREE 100 ('02-'03)  
LIBERTY 50 ('97-'05) - LIBERTY PTT EU2 50 ('04-'05)-RST 2T 50 ('04) - LIBERTY 4T 50 ('00-'02)



### ART. 8413

TRASMISSIONE FRENO POSTERIORE  
REAR BRAKE TRANSMISSION

(Sim.561151)

#### GILERA:

STALKER 50 ('97-'08) - STALKER SPEC. EDITION 50 ('07-'08)



### ART. 8438

TRASMISSIONE FRENO POSTERIORE  
REAR BRAKE TRANSMISSION

(Sim.AP.8214123)

APRILIA: SCARABEO 50 ('93-'05)



### ART. 8416

TRASMISSIONE FRENO POSTERIORE  
REAR BRAKE TRANSMISSION

(Sim.3VLF635100)

MBK: BOOSTER 50 - ROAD 50 - SPIRIT 50







## TRASMISSIONI GAS-STARTER THROTTLE-STARTER TRANSMISSIONS

HIGH QUALITY

ART. **8538**

TRASMISSIONE DA COMANDO GAS A SDOPPIATORE  
TRANSMISSION FROM THROTTLE SHIFT TO SPLITTER

(Sim. 561149)

**GILERA:** STALKER 50 ('97-'08) - SPEC. EDITION 50 ('07-'08)



ART. **8562**

TRASMISSIONE DA COMANDO GAS A SDOPPIATORE  
TRANSMISSION FROM THROTTLE SHIFT TO SPLITTER

(Sim. AP.8214125)

**APRILIA:** SCARABEO 50 ('93-'05)



ART. **8500.60**

TRASMISSIONE  
DA COMANDO GAS A SDOPPIATORE  
TRANSMISSION  
FROM THROTTLE SHIFT TO SPLITTER

(Sim. 17910KTF640)

**HONDA:** SH 125-150 ('04-'05)



ART. **8540**

TRASMISSIONE GAS 1  
THROTTLE 1 TRANSMISSION

(Sim. 3VLF631100)

**MBK:** BOOSTER - BOOSTER NEXT GENERATION



ART. **8541**

TRASMISSIONE GAS 2  
THROTTLE 2 TRANSMISSION

(Sim. 3VLF631200)

**MBK:** BOOSTER - BOOSTER NEXT GENERATION



ART. **8543**

STARTER 2

(Sim. 3VLF633400)

**MBK:** BOOSTER - BOOSTER NEXT GENERATION



# HIGH QUALITY

# TRASMISSIONI CONTAKM. SPEEDOMETER TRANSMISSIONS

**CAVO INTERNO IN ACCIAIO ASSEMBLATO IN BAGNO D'OLIO**  
**GUAINA IN ACCIAIO, RIVESTITA IN PVC (TEMPERATURA DI ESERCIZIO da -25°C a +70°C)**

**STEEL INNER CABLE ASSEMBLED IN OIL BATH**  
**STEEL SHEATH, COVERED IN PVC (OPERATING TEMPERATURE from -25°C to +70°C)**



**LG = LUNGHEZZA GUAINA / SHEATH LENGTH**  
**LC = LUNGHEZZA CAVO / CABLE LENGTH**

I valori riportati nei rispettivi descrittivi articolo si riferiscono alla lunghezza in millimetri di:  
 LG quale lunghezza totale guaina come da disegno  
 LC quale lunghezza cavo

*The values reported in their descriptive items refers to the length in millimeters:*  
 LG which total length sheath as in the drawing  
 LC which cable length

## PIAGGIO

<b>ART. 9418-T</b>  (Sim.648992-646588)	BEVERLY EU3 125 ('07-'08) BEVERLY EU3 SPORT 125 ('07-'08) BEVERLY RST 125 ('05-'07) BEVERLY EU3 MIC 125-250 ('07) BEVERLY 250 ('06-'07) BEVERLY IE EU3 250 ('06-'08) BEVERLY SPORT 250 ('06-'08) BEVERLY TOURER EU3 125 ('07-'10) BEVERLY TOURER EU3 250 ('07-'09)	  <b>LC mm. 1250 - LG mm. 1210</b>
<b>ART. 9561-T</b>  (Sim.599685)	BEVERLY 500 ('02-'06) BEVERLY EURO3 400 ('06-'07) BEVERLY EURO3 500 ('06-'08) BEVERLY TOURER 250 ('07-'08) BEVERLY TOURER EU3 400 ('08-'10)	  <b>LC mm. 1280 - LG mm. 1250</b>
<b>ART. 9560-T</b>  (Sim.649268)	BEVERLY CRUISER 500 ('07-'12)	  <b>LC mm. 1265 - LG mm. 1230</b>
<b>ART. 9417-T</b>  (Sim.600315)	FLY 2T/4T 50 ('05-'07)- 2T 50 (10-11) FLY 4T & 25-30 KM/h 50 (08-11) FLY 4T MOT.CHIN 50 (06-07) FLY 4T 100 (06-08)- FLY 125/150 (05-07) FLY EU3 125 (07-11)-EU3 150 (08-11)	  <b>LC mm. 1040 - LG mm. 1010</b>
<b>ART. 9420-T</b>  (Sim.274643)	HEXAGON 125-150 ('94-'97)	  <b>LC mm. 1100 - LG mm. 1075</b>
<b>ART. 9419-T</b>  (Sim.561279)	HEXAGON LX4 125 ('98-'99) HEXAGON LX-LXT 125-180 ('98-'99) HEXAGON GTX 125-180 ('00) HEXAGON GT-GTX 250 ('98-'00)	  <b>LC mm. 1120 - LG mm. 1110</b>
<b>ART. 9487-T</b>  (Sim.560973)	LIBERTY 50 ('97-'05) LIBERTY 4T 50 ('00-'02) LIBERTY 125 ('98-'02)	  <b>LC mm. 950 - LG mm. 905</b>





## TRASMISSIONI CONTAKM. SPEEDOMETER TRANSMISSIONS

## HIGH QUALITY

**CAVO INTERNO IN ACCIAIO ASSEMBLATO IN BAGNO D'OLIO**  
**GUAINA IN ACCIAIO, RIVESTITA IN PVC (TEMPERATURA DI ESERCIZIO da -25°C a +70°C)**  
**STEEL INNER CABLE ASSEMBLED IN OIL BATH**  
**STEEL SHEATH, COVERED IN PVC (OPERATING TEMPERATURE from -25°C to +70°C)**



### PIAGGIO

ART. <b>9484-T</b>  (Sim.600540)	LIBERTY 2T RST 50 ('04) LIBERTY 4T RST 50 ('04)		LC mm. 950 - LG mm. 910
ART. <b>9485-T</b>  (Sim.647803-600281)	LIBERTY 4T PTT (DEU) 50 ('07-'12) 4T 125('06-'07)-4T EU3 125-200('07-'08) 4T EU3 150 ('08) - 4T EU3 200 ('06) 4T EU3 DELIVERY-SINGLE 125('07-'15) 4T EU3 DELIVERY-TNT 125 ('08-'09) RST 125 ('04-'05) - RST 200 ('04) RST PTT 125 ('05-'11)		LC mm. 980 - LG mm. 935
ART. <b>9472-T</b>  (Sim.272353)	NRG 50 ('94-'96) NTT 50 ('95-'96)		LC mm. 940 - LG mm. 915
ART. <b>9482-T</b>  (Sim.563621)	NRG RST MC2 50 ('96-'98)		LC mm. 960 - LG mm. 925
ART. <b>9473-T</b>  (Sim.268263)	QUARTZ 50 ('92-'96) SKIPPER 125-150 ('94-'97)		LC mm. 1020 - LG mm.1000
ART. <b>9462-T</b>  (Sim.266848)	SFERA 50 ('91-'93) SFERA MAQUILLAGE2 50 ('94) SKR CITY 80 ('99)		LC mm. 1015 - LG mm. 998
ART. <b>9486-T</b>  (Sim.562403)	SFERA RST 50 ('95-'97) SFERA 125 ('95-'97)		LC mm. 1025 - LG mm.1000
ART. <b>5634-T</b>  (Sim.56116R ex 561805)	VESPA ET2 50 ('97-'05) VESPA ET2 INIEZIONE 50 ('97-'00) VESPA ET4 50 ('00-'05) VESPA ET4 125-150 ('96-'02)		LC mm. 1110 - LG mm.1085



# HIGH QUALITY

## TRASMISSIONI CONTAKM. SPEEDOMETER TRANSMISSIONS

**CAVO INTERNO IN ACCIAIO ASSEMBLATO IN BAGNO D'OLIO**  
**GUAINA IN ACCIAIO, RIVESTITA IN PVC (TEMPERATURA DI ESERCIZIO da -25°C a +70°C)**  
**STEEL INNER CABLE ASSEMBLED IN OIL BATH**  
**STEEL SHEATH, COVERED IN PVC (OPERATING TEMPERATURE from -25°C to +70°C)**



### PIAGGIO

#### ART. 10595-T

(Sim.649347 ex 601618  
ex 56307R)

VESPA LX 2T 50-TOURING 50 ('05-'13)  
 LX 125/150('05-'06)-LX EU3 125/150('6-'08)  
 LX EU3 IE 125/150 ('09-'11)  
 LX 4T 50 ('05-'08) - 4T-4V 50 ('09-'13)  
 LX 4T 3V IE TOURING 125/150('12-'13)  
 LX 4T FL 125/150 ('09)  
 LX TOURING 150 ('10-'12)



LC mm. 1105 - LG mm. 1070

#### ART. 10596-T

(Sim.650838 ex 648122)

VESPA LXV 2T 50 ('06-'09)  
 LXV 2T NAVY 50 ('08)  
 LXV 4T EU3 125 ('06-'09)  
 LXV 4T NAVY EU3 125 ('07-'08)  
 LXV 4T 3V IE TOURING 125/150('12-'13)  
 LXV IE 4T 125 ('10-'13)



LC mm. 1095 - LG mm. 1065

#### ART. 10591-T

(Sim.599350)

VESPA GRANTURISMO 125 ('03-'07)  
 GRANTURISMO 200 ('06-'07)  
 GRANTURISMO EU3 125 ('06-'07)  
 GTS EU3 125 ('07-'08)



LC mm. 1150 - LG mm. 1115

#### ART. 10597-T

(Sim.651072)

VESPA GRANTURISMO EU3 125('06-'07)  
 VESPA GTS EU3 125 ('07-'12)



LC mm. 1150 - LG mm. 1120

#### ART. 9564-T

(Sim.601321)

VESPA GTS 250 ('05-'14)  
 GTS ABS 250 ('05-'12)  
 GTS 4T IE SUPER 125 ('09-'14)  
 GTS 4T IE SUPER 150 ('14)  
 GTS SUPER 300 ('08-'14)  
 GTS SUPER SPORT 300 ('10-'13)  
 GTS IE TOURING 300 ('11-'12)



LC mm. 1155 - LG mm. 1130

#### ART. 10598-T

(Sim.650849)

VESPA GTS 250 ('05-'16)  
 GTS SUPER IE 4T 125 ('09-'15)  
 GTS SUPER IE 4T 3V 150 ('14-'15)  
 GTS SUPER 300 ('08-'15)- IE 300 ('12-'14)  
 GTS SUPER SPORT 300 ('10-'13)  
 GTS IE TOURING 300 ('11-'15)



LC mm. 1150 - LG mm. 1125

#### ART. 10599-T

(Sim.650837 ex 649471  
ex 648160)

VESPA GT 60 EU3 250 ('06-'07)  
 GTV 125 ('06-'08) - GTV 250 ('06-'09)  
 GTV 4T NAVY EU3 125 ('08)  
 GTV 4T NAVY EU3 250 ('07)1  
 GTV 4T-4V IE 300 ('10-'13)  
 GTV MONTENAPOLEONE 300 (10)



LC mm. 1170 - LG mm. 1150

#### ART. 10592-T

(Sim.601105)

VESPA PX 30 ANNI 125 ('07-'08)  
 VESPA PX 125-150-200 FRENO A DISCO

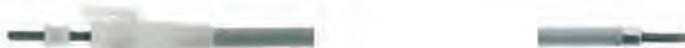

LC mm. 1000 - LG mm. 980

#### ART. 10594-T

(Sim.650836 ex 649623)

VESPA S 2T & COLLEGE 50 ('07-'12)  
 VESPA S 4T-3V IE 125 ('12)  
 VESPA S 4T EU3 125 ('07-'08)  
 VESPA S 4T 150 ('08-'09)  
 V.S 4T IE & COLLEGE 125/150 ('09-'12)



LC mm. 1110 - LG mm. 1090





## TRASMISSIONI CONTAKM. SPEEDOMETER TRANSMISSIONS

# HIGH QUALITY

**CAVO INTERNO IN ACCIAIO ASSEMBLATO IN BAGNO D'OLIO**  
**GUAINA IN ACCIAIO, RIVESTITA IN PVC (TEMPERATURA DI ESERCIZIO da -25°C a +70°C)**

**STEEL INNER CABLE ASSEMBLED IN OIL BATH**  
**STEEL SHEATH, COVERED IN PVC (OPERATING TEMPERATURE from -25°C to +70°C)**

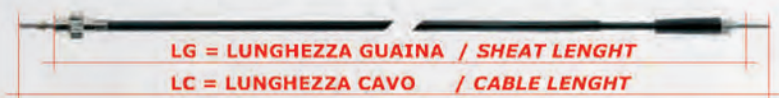

### PIAGGIO

ART. <b>9463-T</b> (Sim.269062)	ZIP		LC mm. 925 - LG mm. 905
ART. <b>9469-T</b> (Sim.574331)	ZIP 50 ('92-'96) ZIP BIMODALE 50 ('94-'97) ZIP FAST RAIDER 50 ('93-'94)		LC mm. 950 - LG mm. 930
ART. <b>9489-T</b> (Sim.273817)	ZIP RST 50 ('96-'99)		LC mm. 953 - LG mm. 915
ART. <b>9488-T</b> (Sim.582507 ex 561997)	ZIP SP 50 ('96-'04) ZIP SP EURO2 50 ('06-'13) ZIP 125 ('00-'02)		LC mm. 1075 - LG mm. 1060

### GILERA

ART. <b>9493-T</b> (Sim.561710)	RUNNER 50 ('97-'00)		LC mm. 990 - LG mm. 940
ART. <b>9492-T</b> (Sim.563412)	RUNNER FX-FXR 125-180 ('97-'02)		LC mm. 1000 - LG mm. 970
ART. <b>9494-T</b> (Sim.561152)	STALKER 50 ('97-'08) STALKER SPECIAL EDITION 50 ('07-'08)		LC mm. 980 - LG mm. 950
ART. <b>9472-T</b> (Sim.272353)	TYPHOON 50 ('94-'99)		LC mm. 940 - LG mm. 915 (TIPO CORTO / SHORT TYPE)
ART. <b>9482-T</b> (Sim.563621)	TYPHOON 50 ('01-'04) TYPHOON XR 50 ('00) - MY 125 ('97) TYPHOON X-XR 125('95)		LC mm. 960 - LG mm. 925 (TIPO LUNGO / LONG TYPE)



# HIGH QUALITY

## TRASMISSIONI CONTACTM. SPEEDOMETER TRANSMISSIONS

**CAVO INTERNO IN ACCIAIO ASSEMBLATO IN BAGNO D'OLIO**  
**GUAINA IN ACCIAIO, RIVESTITA IN PVC (TEMPERATURA DI ESERCIZIO da -25°C a +70°C)**  
**STEEL INNER CABLE ASSEMBLED IN OIL BATH**  
**STEEL SHEATH, COVERED IN PVC (OPERATING TEMPERATURE from -25°C to +70°C)**



### APRILIA

<b>ART. 9470-T</b> (Sim.8214126)	SCARABEO 50 ('93-'05) SCARABEO STREET 50 ('05-'06) SCARABEO STREET 2T RESTYLING 50 ('06-'09)	 <b>LC mm. 930 - LG mm. 890</b>
<b>ART. 9451-T</b> (Sim.8114357)	SCARABEO 125	 <b>GUAINA A 2 FILI TRAFILATI</b> <b>LC mm. 1010 - LG mm. 985</b>
<b>ART. 9453-T</b> (Sim.8214163)	SR 50 DITECH EURO2 ('02-'04) SR H20 DITECH E CARB. 50 ('00-'04) SR STEALTH, RACING 50 ('97-'00) SR STREET 50 ('03-'12) SR WWW 50 ('97-'01) SR 125 ('99-'01)	 <b>LC mm. 895 - LG mm. 875</b>

### HONDA

<b>ART. 9495-T</b> (Sim. 44830GAV700)	BALI 50 BALI SJ 50	 <b>GUAINA A 2 FILI TRAFILATI</b> <b>LC mm. 1175 - LG mm. 1150</b>
<b>ART. 9502-T</b> (Sim. 44830KGF900)	@ CHIOCCIOLA NES 125-150	 <b>GUAINA A 2 FILI TRAFILATI</b> <b>LC mm. 1030 - LG mm. 1010</b>
<b>ART. 9504-T</b> (Sim. 44830KPR900)	SH 125-150	 <b>GUAINA A 2 FILI TRAFILATI</b> <b>LC mm. 930 - LG mm. 910</b>





## TRASMISSIONI CONTACTM. SPEEDOMETER TRANSMISSIONS

# HIGH QUALITY

**CAVO INTERNO IN ACCIAIO ASSEMBLATO IN BAGNO D'OLIO**  
**GUAINA IN ACCIAIO, RIVESTITA IN PVC (TEMPERATURA DI ESERCIZIO da -25°C a +70°C)**  
**STEEL INNER CABLE ASSEMBLED IN OIL BATH**  
**STEEL SHEATH, COVERED IN PVC (OPERATING TEMPERATURE from -25°C to +70°C)**

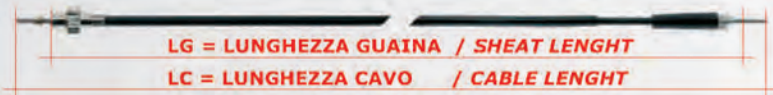

### KYMCO

ART. **9546-T**

(Sim. 44830KBE9000)

DINK 125-150  
DINK LX 125-150



ART. **9540-T**

(Sim. 44830KFA6900)

PEOPLE 50 ('99)  
PEOPLE 125 - 150



### MBK - YAMAHA

ART. **9430-T**

(Sim. 4PAH355002)

**MBK:** BOOSTER 50 ('01) - R.  
SPIRIT 50 ('94-'95)  
SPIRIT KAT 50 ('96-'00)  
**YAMAHA:** BREEZE 50 ('94-'95)  
BWS ORIGINAL

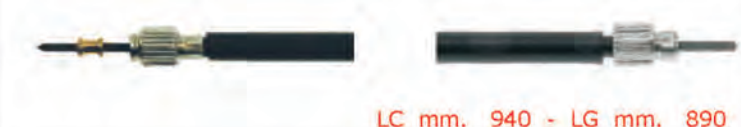

ART. **9483-T**

(Sim. 4SRH355030)

**MBK:** BOOSTER  
NEXT GENERATION  
ROCKET  
**YAMAHA:** BWS - SPY



ART. **9434-T**

(Sim. 5BRH355020)

**MBK:** NITRO 50 ('97-'00)  
NITRO 100  
OVETTO 50  
**YAMAHA:** AEROX 50 ('97-'00)  
NEO's 50 ('97-'00)



ART. **9460-T**

(Sim. 5PUH35500100)

**MBK:** NITRO 50 ('02)  
NITRO EU2 50 ('03)  
NITRO 100 ('02)  
**YAMAHA:** AEROX 50 ('02)  
AEROX 50 EU2 ('03)  
AEROX 100 ('02)



ART. **9436-T**

(Sim. 4HC8335000)

**MBK:** SKYLINER 250 ('00-'04)  
**YAMAHA:** MAJESTY 250 ('96-'00)





# HIGH QUALITY

## TRASMISSIONI CONTAKM. SPEEDOMETER TRANSMISSIONS

**CAVO INTERNO IN ACCIAIO ASSEMBLATO IN BAGNO D'OLIO**  
**GUAINA IN ACCIAIO, RIVESTITA IN PVC (TEMPERATURA DI ESERCIZIO da -25°C a +70°C)**

**STEEL INNER CABLE ASSEMBLED IN OIL BATH**  
**STEEL SHEATH, COVERED IN PVC (OPERATING TEMPERATURE from -25°C to +70°C)**



### MALAGUTI

ART. **9519-T**

(Sim. 17819400)

BLOG IE 125-160 ('09)  
 CENTRO 4T 50('08)  
 CENTRO IE 125-160('08-'09)  
 CENTRO SL IE 125 ('09)  
 CENTRO SL IE 160 ('09)



LC mm. 1125 - LG mm. 1100

ART. **9471-T**

(Sim. 17809400)

F12 PHANTOOM H20 50 - 100  
 F15 FIRE FOX

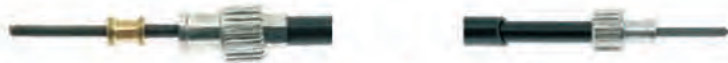

LC mm. 1050 - LG mm. 1000

ART. **9522-T**

(Sim. 17813300)

F12 ('99)



LC mm. 1055 - LG mm. 1030

### PEUGEOT

ART. **9428-T**

(Sim. 732615)

BUXI  
 SPEEDAKE 50 ('94-'97)



LC mm. 1065 - LG mm. 1045

ART. **9438-T**

(Sim. 762744)

LUDIX 10 TREND  
 LUDIX 14 ELEGANT 50 ('04)  
 SNAKE 50 ('04)



LC mm. 945 - LG mm. 910

ART. **9439-T**

(Sim. 762745)

LUDIX 10 ONE 50 ('04)  
 LUDIX 14 CLASSIC 50 ('04)



LC mm. 835 - LG mm. 830

ART. **9441-T**

(Sim. 736610)

SPEEDFIGHT 50-100 ARIA/AIR  
 SPEEDFIGHT 50-100 H20 - AT ('97-'99)



LC mm. 1103 - LG mm. 1083





## TRASMISSIONI CONTAKM. SPEEDOMETER TRANSMISSIONS

## HIGH QUALITY

### (TABELLA PER RICERCA TRASMISSIONE CONTAKM. PER VEICOLO) (SPEEDOMETER TRANSMISSION LIST, SEARCH FOR VEHICLE)

**CAVO INTERNO IN ACCIAIO ASSEMBLATO IN BAGNO D'OLIO**  
**GUAINA IN ACCIAIO, RIVESTITA IN PVC (TEMPERATURA DI ESERCIZIO da -25°C a +70°C)**

**STEEL INNER CABLE ASSEMBLED IN OIL BATH**  
**STEEL SHEATH, COVERED IN PVC (OPERATING TEMPERATURE from -25°C to +70°C)**

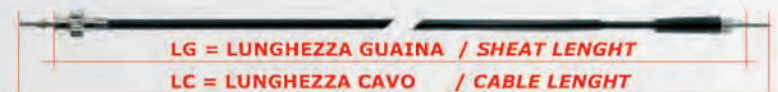

APILIA	LC	LG	CIF ART.	RIF. ORIGINALE
SCARABEO 50 ('93-'05)	mm. 930	mm. 890	<b>9470-T</b>	8214126
SCARABEO 125	mm.1010	mm. 985	<b>9451-T</b>	8114357
SCARABEO STREET 50 ('05-'06)	mm. 930	mm. 890	<b>9470-T</b>	8214126
SCARABEO STREET 2T RESTYLING 50 ('06-'09)	mm. 930	mm. 890	<b>9470-T</b>	8214126
SR 50 DITECH EURO2 ('02-'04)	mm. 895	mm. 875	<b>9453-T</b>	8214163
SR H20 DITECH E CARB. 50 ('00-'04)	mm. 895	mm. 875	<b>9453-T</b>	8214163
SR STEALTH, RACING 50 ('97-'00)	mm. 895	mm. 875	<b>9453-T</b>	8214163
SR STREET 50 ('03-'12)	mm. 895	mm. 875	<b>9453-T</b>	8214163
SR WWW 50 ('97-'01)	mm. 895	mm. 875	<b>9453-T</b>	8214163
SR 125 ('99-'01)	mm. 895	mm. 875	<b>9453-T</b>	8214163

GILERA	LC	LG	CIF ART.	RIF. ORIGINALE	
RUNNER 50 ('97-'00)	mm. 990	mm. 940	<b>9493-T</b>	561710	
RUNNER FX-FXR 125-180 ('97-'02)	mm.1000	mm. 970	<b>9492-T</b>	563412	
STALKER 50 ('97-'08)	mm. 980	mm 950	<b>9494-T</b>	561152	
STALKER SPECIAL EDITION 50 ('07-'08)	mm. 980	mm 950	<b>9494-T</b>	561152	
TYPHOON 50 ('94-'99)	<b>TIPO CORTO/SHORT TYPE</b>	mm. 940	mm. 915	<b>9472-T</b>	272353
TYPHOON 50 ('01-'04)	<b>TIPO LUNGO/LONG TYPE</b>	mm. 960	mm. 925	<b>9482-T</b>	563621
TYPHOON XR 50 ('00) - MY 125 ('97)	mm. 960	mm. 925	<b>9482-T</b>	563621	
TYPHOON X-XR 125('95)	mm. 960	mm. 925	<b>9482-T</b>	563621	

HONDA	LC	LG	CIF ART.	RIF. ORIGINALE
BALI 50	mm.1175	mm.1150	<b>9495-T</b>	44830GAV700
BALI SJ 50	mm.1175	mm.1150	<b>9495-T</b>	44830GAV700
@ CHIOCCIOLA NES 125-150	mm.1030	mm.1010	<b>9502-T</b>	44830KGF900
SH 125/150	mm. 930	mm. 910	<b>9504-T</b>	44830KPR900

MBK	LC	LG	CIF ART.	RIF. ORIGINALE
BOOSTER 50 ('01) - R	mm. 940	mm. 890	<b>9430-T</b>	4PAH355002
BOOSTER NEXT GENERATION - ROCKET	mm. 925	mm. 905	<b>9483-T</b>	4SRH355030
BOOSTER SPIRIT 50 ('94-'95)	mm. 940	mm. 890	<b>9430-T</b>	4PAH355002
BOOSTER SPIRIT KAT 50 ('96-'00)	mm. 940	mm. 890	<b>9430-T</b>	4PAH355002
NITRO 50 ('97-'00)	mm. 985	mm. 965	<b>9434-T</b>	5BRH355020
NITRO 50 ('02)	mm. 990	mm. 945	<b>9460-T</b>	5PUH35500100
NITRO EU2 50 ('03)	mm. 990	mm. 945	<b>9460-T</b>	5PUH35500100
NITRO 100	mm. 985	mm. 965	<b>9434-T</b>	5BRH355020
NITRO 100 ('02)	mm. 990	mm. 945	<b>9460-T</b>	5PUH35500100
SKYLINER 250 ('00-'04)	mm. 925	mm. 885	<b>9436-T</b>	4HC8335000



# HIGH QUALITY

# TRASMISSIONI CONTAKM. SPEEDOMETER TRANSMISSIONS

## (TABELLA PER RICERCA TRASMISSIONE CONTAKM. PER VEICOLO) (SPEEDOMETER TRANSMISSION LIST, SEARCH FOR VEHICLE)

**CAVO INTERNO IN ACCIAIO ASSEMBLATO IN BAGNO D'OLIO**  
**GUAINA IN ACCIAIO, RIVESTITA IN PVC (TEMPERATURA DI ESERCIZIO da -25°C a +70°C)**  
**STEEL INNER CABLE ASSEMBLED IN OIL BATH**  
**STEEL SHEATH, COVERED IN PVC (OPERATING TEMPERATURE from -25°C to +70°C)**



PIAGGIO	LC	LG	CIF ART.	RIF. ORIGINALE
BEVERLY 250 ('06-'07)	mm.1250	mm.1210	<b>9418-T</b>	648992-646588
BEVERLY 500 ('02-'06)	mm.1280	mm.1250	<b>9561-T</b>	599685
BEVERLY EU3 125 ('07-'08)	mm.1250	mm.1210	<b>9418-T</b>	648992-646588
BEVERLY EU3 400 ('06-'07) - BEVERLY EU3 500 ('06-'08)	mm.1280	mm.1250	<b>9561-T</b>	599685
BEVERLY EU3 SPORT 125 ('07-'08)	mm.1250	mm.1210	<b>9418-T</b>	648992-646588
BEVERLY EU3 MIC 125-250 ('07)	mm.1250	mm.1210	<b>9418-T</b>	648992-646588
BEVERLY CRUISER 500 ('07-'12)	mm.1265	mm.1230	<b>9560-T</b>	649268
BEVERLY IE EU3 250 ('06-'08) - RST 125 ('05-'07) - SPORT 250 ('06-'08)	mm.1250	mm.1210	<b>9418-T</b>	648992-646588
BEVERLY TOURER 250 ('07-'08)	mm.1280	mm.1250	<b>9561-T</b>	599685
BEVERLY TOURER EU3 125 ('07-'10) - TOURER EU3 250 ('07-'09)	mm.1250	mm.1210	<b>9418-T</b>	648992-646588
BEVERLY TOURER EU3 400 ('08-'10)	mm.1280	mm.1250	<b>9561-T</b>	599685
HEXAGON 125-150 ('94-'97)	mm.1100	mm.1075	<b>9420-T</b>	274643
HEXAGON LX4 125 ('98-'99) - HEXAGON LX-LXT 125-180 ('98-'99)	mm.1120	mm.1110	<b>9419-T</b>	561279
HEXAGON GTX 125-180 ('00) - HEXAGON GT-GTX 250 ('98-'00)	mm.1120	mm.1110	<b>9419-T</b>	561279
LIBERTY 50 ('97-'05)	mm. 950	mm. 905	<b>9487-T</b>	560973
LIBERTY 2T RST 50 ('04)	mm. 950	mm. 910	<b>9484-T</b>	600540
LIBERTY 4T 50 ('00-'02)	mm. 950	mm. 905	<b>9487-T</b>	560973
LIBERTY 4T 125('06-'07) - EU3 125-200('07-'08) - 4T EU3 150 ('08) - 4T EU3 200 ('06)	mm. 980	mm. 935	<b>9485-T</b>	647803-600281
LIBERTY 4T EU3 DELIVERY-SINGLE 125('07-'15)-4T EU3 DELIVERY-TNT 125 ('08-'09)	mm. 980	mm. 935	<b>9485-T</b>	647803-600281
LIBERTY 4T RST 50 ('04)	mm. 950	mm. 910	<b>9484-T</b>	600540
LIBERTY RST 125 ('04-'05)-RST 200 ('04)	mm. 980	mm. 935	<b>9485-T</b>	647803-600281
LIBERTY-RST PTT 125 ('5-'11) 4T PTT (DEU) 50 ('7-'12)	mm. 980	mm. 935	<b>9485-T</b>	647803-600281
LIBERTY 125 ('98-'02)	mm. 950	mm. 905	<b>9487-T</b>	560973
NRG 50 ('94-'96) - NTT 50 ('95-'96)	mm. 940	mm. 915	<b>9472-T</b>	272353
NRG RST MC2 50 ('96-'98)	mm. 960	mm. 925	<b>9482-T</b>	563621
QUARTZ 50 ('92-'96)	mm.1020	mm.1000	<b>9473-T</b>	268263
SFERA 50 ('91-'93) - SFERA MAQUILLAGE2 50 ('94)	mm.1015	mm. 998	<b>9462-T</b>	266848
SFERA RST 50 ('95-'97) - SFERA 125 ('95-'97)	mm.1025	mm.1000	<b>9486-T</b>	562403
SKR CITY 80 ('99)	mm.1015	mm. 998	<b>9462-T</b>	266848
SKIPPER 125-150 ('94-'97)	mm.1020	mm.1000	<b>9473-T</b>	268263
VESPA ET2 50 ('97-'05) - ET2 INIEZIONE 50 ('97-'00)	mm.1110	mm.1085	<b>5634-T</b>	56116R-561805
VESPA ET4 50 ('00-'05) - VESPA ET4 125-150 ('96-'02)	mm.1110	mm.1085	<b>5634-T</b>	56116R-561805
VESPA LX 2T 50 - LX 125/150('05-'06)	mm.1105	mm.1070	<b>10595-T</b>	649347-601618-56307R
VESPA LX EU3 125/150('06-'08) - VESPA LX EU3 IE 125/150 ('09-'11)	mm.1105	mm.1070	<b>10595-T</b>	649347-601618-56307R
VESPA LX 4T 50 ('05-'08) - 4T-4V 50 ('09-'13) - LX 4T FL 125/150 ('09)	mm.1105	mm.1070	<b>10595-T</b>	649347-601618-56307R
VESPA LX 4T 3V IE TOURING 125/150 ('12-'13)	mm.1105	mm.1070	<b>10595-T</b>	649347-601618-56307R
VESPA LX TOURING 50 ('05-'13) - LX TOURING 150 ('10-'12)	mm.1105	mm.1070	<b>10595-T</b>	649347-601618-56307R
VESPA LXV 2T 50 ('06-'09) - LXV 2T NAVY 50 ('08)	mm.1095	mm.1065	<b>10596-T</b>	650838-648122
VESPA LXV 4T EU3 125 ('06-'09) - LXV 4T NAVY EU3 125 ('07-'08)	mm.1095	mm.1065	<b>10596-T</b>	650838-648122
VESPA LXV 4T 3V IE TOURING 125/150('12-'13) - LXV IE 4T 125 ('10-'13)	mm.1095	mm.1065	<b>10596-T</b>	650838-648122
VESPA GRANTURISMO 125 ('03-'07)-GRANTURISMO 200 ('06-'07)-EU3 125 ('06-'07)	mm.1150	mm.1115	<b>10591-T</b>	599350
VESPA GRANTURISMO EU3 125 ('06-'07)	mm.1150	mm.1120	<b>10597-T</b>	651072
VESPA GT 60 EU3 250 ('06-'07)	mm.1170	mm.1150	<b>10599-T</b>	650837-649471-648160





## TRASMISSIONI CONTAKM. SPEEDOMETER TRANSMISSIONS

## HIGH QUALITY

### (TABELLA PER RICERCA TRASMISSIONE CONTAKM. PER VEICOLO) (SPEEDOMETER TRANSMISSION LIST, SEARCH FOR VEHICLE)

**CAVO INTERNO IN ACCIAIO ASSEMBLATO IN BAGNO D'OLIO**  
**GUAINA IN ACCIAIO, RIVESTITA IN PVC (TEMPERATURA DI ESERCIZIO da -25°C a +70°C)**

**STEEL INNER CABLE ASSEMBLED IN OIL BATH**  
**STEEL SHEATH, COVERED IN PVC (OPERATING TEMPERATURE from -25°C to +70°C)**

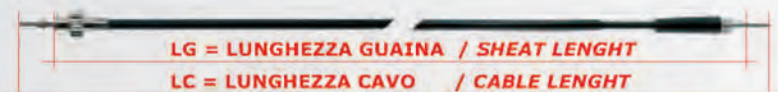

PIAGGIO	LC	LG	CIF ART.	RIF. ORIGINALE
VESPA GTS EU3 125 ('07-'08)	mm.1150	mm.1115	<b>10591-T</b>	599350
VESPA GTS EU3 125 ('07-'12)	mm.1150	mm.1120	<b>10597-T</b>	651072
VESPA GTS 250 ('05-'14)	mm.1155	mm.1130	<b>9564-T</b>	601321
VESPA GTS 250 ('05-'16)	mm.1150	mm.1125	<b>10598-T</b>	650849
VESPA GTS ABS 250 ('05-'12)	mm.1155	mm.1130	<b>9564-T</b>	601321
VESPA GTS 4T IE SUPER 125 ('09-'14) - GTS 4T IE SUPER 150 ('14)	mm.1155	mm.1130	<b>9564-T</b>	601321
VESPA GTS SUPER 300 ('08-'14)	mm.1155	mm.1130	<b>9564-T</b>	601321
VESPA GTS SUPER 300 ('08-'15)	mm.1150	mm.1125	<b>10598-T</b>	650849
VESPA GTS SUPER IE 4T 125 ('09-'15) - GTS SUPER IE 4T 3V 150 ('14-'15)	mm.1150	mm.1125	<b>10598-T</b>	650849
VESPA GTS SUPER IE 300 ('12-'14)	mm.1150	mm.1125	<b>10598-T</b>	650849
VESPA GTS SUPER SPORT 300 ('10-'13)	mm.1155	mm.1130	<b>9564-T</b>	601321
VESPA GTS SUPER SPORT 300 ('10-'13)	mm.1150	mm.1125	<b>10598-T</b>	650849
VESPA GTS IE TOURING 300 ('11-'12)	mm.1155	mm.1130	<b>9564-T</b>	601321
VESPA GTS IE TOURING 300 ('11-'15)	mm.1150	mm.1125	<b>10598-T</b>	650849
VESPA GTV 125 ('06-'08) - GTV 250 ('06-'09)	mm.1170	mm.1150	<b>10599-T</b>	650837-649471-648160
VESPA GTV 4T NAVY EU3 125 ('08) -GTV 4T NAVY EU3 250 ('07)	mm.1170	mm.1150	<b>10599-T</b>	650837-649471-648160
VESPA GTV 4T-4V IE 300 ('10-'13)	mm.1170	mm.1150	<b>10599-T</b>	650837-649471-648160
GTV MONTENAPOLEONE 300 (10)	mm.1170	mm.1150	<b>10599-T</b>	650837-649471-648160
VESPA PX 30 ANNI 125 ('07-'08)	mm.1000	mm. 980	<b>10592-T</b>	601105
VESPA PX 125-150-200 FRENO A DISCO	mm.1000	mm. 980	<b>10592-T</b>	601105
VESPA S 2T & COLLEGE 50 ('07-'12)	mm.1110	mm.1090	<b>10594-T</b>	650836-649623
VESPA S 4T 150 ('08-'09) - S 4T EU3 125 ('07-'08)	mm.1110	mm.1090	<b>10594-T</b>	650836-649623
VESPA S 4T - 3V IE 125 ('12) - S 4T IE & COLLEGE 125/150 ('09-'12)	mm.1110	mm.1090	<b>10594-T</b>	650836-649623
ZIP	mm. 925	mm. 905	<b>9463-T</b>	269062
ZIP 50 ('92-'96)	mm. 950	mm. 930	<b>9469-T</b>	574331
ZIP 125 ('00-'02)	mm.1075	mm.1060	<b>9488-T</b>	582507-561997
ZIP BIMODALE 50 ('94-'97)	mm. 950	mm. 930	<b>9469-T</b>	574331
ZIP FAST RAIDER 50 ('93-'94)	mm. 950	mm. 930	<b>9469-T</b>	574331
ZIP RST 50 ('96-'99)	mm. 953	mm. 915	<b>9489-T</b>	273817
ZIP SP 50 ('96-'04) - ZIP SP EURO2 50 ('06-'13)	mm.1075	mm.1060	<b>9488-T</b>	582507-561997

YAMAHA	LC	LG	CIF ART.	RIF. ORIGINALE
AEROX 50 ('97-'00)	mm. 985	mm. 965	<b>9434-T</b>	5BRH355020
AEROX 50 ('02) - AEROX 50 EU2 ('03)	mm. 990	mm. 945	<b>9460-T</b>	5PUH35500100
AEROX 100 ('02)	mm. 990	mm. 945	<b>9460-T</b>	5PUH35500100
BREEZE 50 ('94-'95)	mm. 940	mm. 890	<b>9430-T</b>	4PAH355002
BW'S ORIGINAL	mm. 940	mm. 890	<b>9430-T</b>	4PAH355002
BW'S - SPY	mm. 925	mm. 905	<b>9483-T</b>	4SRH355030
NITRO 100	mm. 985	mm. 965	<b>9434-T</b>	5BRH355020
NITRO 100 ('02)	mm. 990	mm. 945	<b>9460-T</b>	5PUH35500100
MAJESTY 250 ('96-'00)	mm. 925	mm. 885	<b>9436-T</b>	4HC8335000



## SERRATURE

### SECURITY LOCKS ON THE STEERING



ART. **6216**

SERIE SERRATURE (N. 2 CILINDRETTI + N. 2 CHIAVI)  
SECURITY LOCKS SET (N.2 CYLINDERS + 2 KEYS)

(Sim. 2577032)

**PIAGGIO:**

FREE FL 50 (95-02) - FREE DELIVERY 50 (00-01) FREE 100 (02-03)  
NRG EXTREME 50 (99-00) - NRG MC3 50 (01-04) - NRG PUREJET 50 (02-04)  
NRG RST MC2 50 (96-98) - NTT 50 (95-19) - VELOFAX 50 (96-99)  
PUCH P1-TRE 50 (93-98)

**GILERA:**

TYPHOON 50 (05-11) - STORM EU2 50 (2007)



ART. **6217**

SERIE SERRATURE (N. 3 CILINDRETTI + N. 2 CHIAVI)  
SECURITY LOCKS SET (N.3 CYLINDERS + 2 KEYS)

(Sim. 259547)

**PIAGGIO:**

ZIP - ZIP FAST RIDER



ART. **6210-3**

SERIE 3 CILINDRETTI + 2 CHIAVI  
SET WITH 3 CYLINDERS + 2 KEYS

(Sim. 179292)

**PIAGGIO:**

FREE 50 (92-94) - NRG 50 (94-96) - NTT 50 (95-96) - QUARTZ 50 (92-96)  
SFERA 50 (91-93) - 125 (95-97) - MAQUILLAGE 2 50 (1994) - SFERA RST 50 (95-97)  
SKIPPER 125 (94-97) - SKR CITY 80 (1999) - ZIP 50 (92-93) - ZIP 50 (95-96)  
ZIP FAST RAIDER 50 (93-94) VESPA PX 150 (11-17) - PX 30 ANNI 125 (07-08)  
VESPA PX EU2 125 (01-07) - VESPA PX 125/150 (11-17)  
VESPA N 50 (89-90) - PK 50 (82-84) - PK XL 50 (85-88) - PK XL 125 (86-89)  
VESPA PK XL PLURIMATIC 50 (85-90) - PK XL RUSH 50 (88-89) - PXE ARCOBALENO 125 (81-97)  
VESPA T5 125 (85-89) - VESPA PX 125 (98-01) - COSA CL-CLX 125 (88-91)

**GILERA:**

EASY MOVING 50 (95-96) - STORM 50 (94-95) - TYPHOON 50 (94-97)-50 (01-04)  
TYPHOON X 50 (98-99) - XR 50 (00) - TYPHOON 125 (95-98) - X-XR 125 (99-00)

ART. **6219**

SERIE SERRATURE (N. 2 CILINDRETTI + N. 2 CHIAVI)  
SET WITH 2 CYLINDERS + 2 KEYS

(Sim. 5735125)

**PIAGGIO:**

FLY 2T 50 (05-07/10-11)-FLY 4T 50 (05-07)-FLY 4T MOT.CHIN 50 (06-07)  
FLY 4T & 25-30 KM/H 50 (08-11) - FLY 4T 100 (06-14) - FLY EU3 125/150 (07-11)  
LIBERTY 50 (97-05) - 125 (98-02) - 2T50 (06-08) - 2T RST 50 (2004) - 2T SPORT 50 (06-08)  
LIBERTY 4T 50 (00-02/05-08) - 4T RST 50 (2004) - 4T SPORT 50(06-08) - 4T EU3 150 (2008)  
LIBERTY PTT EU2 50 (04-05) - 4T PTT (DEU) 50 (07-12) - 4T PTT - DOUBLE - NEXIVE 50 (09-19)  
LIBERTY ELETTRICO PPT AUT (2011) - 4T 2V EU3 125 (09-12) - 4T 2V IE PTT - ITA 125 (12-13)  
LIBERTY 4T DELIVERY TNT 50 (2009) - 4T DELIVERY SINGLE 50 (10-14) - MOC 2T & ELLE 50 (09-13)  
LIBERTY MOC 4T & ELLE 50 (09-16) - MOC 4T EU3 150 (09-13)  
LIBERTY 4T IGET CORPORATE E4 50 (2018) - IGET 4T 3V IE E4 EMEA 50 (17-19)  
ZIP 50 (00-04) - 125 (00-02) - 2T 50 (08-13) - 4T 50 (00-13)-4T 100 (06-10) - ZIP SP 50 (01-04)  
ZIP SP EURO2 50 (06-13) - ZIP 4T 25KM-H 50 (06-16/18-19) - ZIP 4T E4 50 (2018)

**GILERA:**

TYPHOON 2T EURO2 50 (10-16)







## BLOCCHETTI ON-OFF

### ON-OFF SWITCHES

ART. **6220**

BLOCCHETTO ON-OFF

(Sim.1B002607-298581)



**PIAGGIO:**

BEVERLY 125 (01-03)-250 (05-07)-500 (02-06)-4T 4V IE EURO3 SPORT TOURING 350 (11-14)-4T ST IE ABS 350 (16-19)-CRUISER 250 (07-09)-CRUISER 500 (07-12)-EU3 125 (07-08)-EU3 400 (06-07)-EU3 500(06-08)-EU3 MIC 125/250(2007)-EU3 SPORT 125(07-08)-IE EU3 250 (06-08)-RST 125 (04-07)-RST 250 (04-05)-RST 4T 4V IE EU3 125/300 (10-15)-SPORT 250 (06-08)-TOURER EU3 125 (07-10)-TOURER EU3 250 (07-09)-TOURER EU3 300 (09-10) TOURER EU3 400 (08-10)-IE ABS E4 (EMEA) 300 (16-19)-CARNABY 125 (07-10)-200 (07-08)-250 (08-09) CARNABY CRUISER 300 (09-12)-FLY 125/150 (05-07)-2T/4T 50 (05-07)-2T 50 (10-11)-4T & 25-30 KM/H 50 (08-11) FLY 4T 100 (06-14) FLY 4T MOT.CHN 50 (06-07) - FLY EU3 125 (2007) - FLY EU3 125/150 (08-11) HEXAGON GT-GTX 250 (98-00)-GTX 125 (2000)-LX-LXT-LX4 125 (98-99)-SUPER HEXAGON GTX 12 125 (01-02) LIBERTY 50 (97-05)-125 (98-02)-200 (2006)-2T 50 (06-08)-2T RST 50 (2004)-2T SPORT 50 (06-08)-4T 50 (00-02/05-08) 4T 125 (06-07) - 4T 2V EU3 125 (09-12) - 4T 2V IE PTT-ITA 125 (12-13) - 4T EU3 125/200 (06-08) - 4T EU3 150 (2008) 4T DELIVERY - SINGLE 50 (10-14) 4T DELIVERY TNT 50 (2009) - 4T EU3 DELIVERY-SINGLE 125 (07-15) 4T EU3 DELIVERY-TNT-NEXIVE 125 (08-15) - 4T PTT (DEU) 50 (07-12) - 4T PTT-DOUBLE-NEXIVE 50 (09-17) 4T RST 50 (2004)-SPORT 125/200 (2006)-4T SPORT 50 (06-08)-4T SPORT EU3 125 (06-08)-4T SPORT EU3 150 (2008) 4T SPORT EU3 200 (06-07)-4T IGET CORPORATE E4 50 (2018)-4T IGET CORPORATE E4 125 (17-19)-ELETTRICO PPT AUT (2011) - MOC 4T & ELLE 50 (09-16) - MOC 4T EU3 150 (09-13) - PTT EU2 50 (04-05) - RST 125 (04-05) RST 200 (2004)-RST PTT 125 (05-11)-NRG POWER DD 50 (2005/07-17)-DD SERIE SPECIALE 50 (07-12)-DT 50 (07-15) NRG POWER DT SERIE SPECIALE 50 (07-08) - PUREJET 50 (07-11)-PUREJET 50 (2010)-SKIPPER 4T 125 (00-02) LX 125 (98-99)-VESPA ET2 50 (97-05) - ET2 INIEZIONE 50 (97-00) - ET4 50 (00-05) - ET4 125 (96-02) GRANTURISMO 125 (03-07) - GRANTURISMO 200 (06-07) - GRANTURISMO EU 3 125 (06-07) GT 60 EU 3 250 (06-07) - GTS 250 (05-14)-GTS 4T IE SUPER 125 (09-16)-GTS ABS 250 (05-12)-GTS EU3 125 (07-12) GTS IE & TOURING 300 (12-16)-GTS IE TOURING 300 (11-12)-SUPER 300 (08-16)-GTS SUPER IE 4T 3V AU, EX, JP, RI,T,V 150 (14-15)-GTS SUPER SPORT 300 (10-13) GTV 125 (06-08) - GTV 250 (06-09) - GTV 4T 4V IE 300 (10-13) GTV 4T NAVY EU3 125 (2008)-GTV 4T NAVY EU3 250 (2007) - GTV VIA MONTENAPOLEONE 300 (2010) VESPA LX 125/150 (05-06)-LX 2T 50 (05-13)-LX 2T TOURING & 30KM 50 (10-13)-LX 4T 50 (05-09)-LX 4T 3V IE TOURING 125/150 (12-13) - LX 4T EU3 TOURING 125 8 (10-11) - LX 4T FL 125/150 (2009) - LX 4T-4V 50 (09-13) LX 4T-4V TOURING 50 (10-13) - LX EU3 125/150 (06-08) - LX EU3 IE 125/150 (09-11) - LX TOURING 150 (10-12) LXV 2T 50 (06-09)-LXV 2T NAVY 50 (2008)-LXV 4T EU3 125 (06-09)-LXV 4T NAVY EU3 125 (07-08)-IE 4T 125 (10-13) VESPA S 2T & COLLEGE 50 (07-12) - S 4T 150 (08-09) - S 4T EU 3 125 (07-08) - S 4T IE & COLLEGE 150 (09-12) S 4T-4V & COLLEGE 50 (08-12)-X EVO 125 (07-16)-250 (07-13)-400 (07-11)-X10 4T 4V IE EURO3 125/350/500 (12-15) X7 EU3 125/250 (2008)-X7 EVO IE EU3 125/300(09-10)-X8 125 (04-06)-200 (05-07)-EU3 250 (05-08)-EU3 400 (06-08) PREMIUM EU2 125 (2006) - PREMIUM EU3 125 (06-07) - STREET EU2 125 (06-07) - STREET EU2 150 (06-08) X9 125/500 (01-02)-200 (02-03) - 250 (00-01) - AMALFI 180 (00-03)-EVOLUTION 125 (2003/05-06)-EVOL.200 (2003) EVOLUTION 250 (2004/2006)-EVOL.500 (03-07)-EVOL.ABS 500 (06-07) - EVOL. EU3 125 (2007) - ZIP 50 (00-04) ZIP 125 (00-02) - 2T 50 (08-13) - 4T 50 (00-13) 4T 100(06-10) - ZIP 4T 25KM-H 50 (06-16/18-19) - 4T E4 50 (18-19) ZIP SP 50 (01-04) - SP EU2 50 (06-13)

**GILERA:**

ICE 50 (01-05) - RUNNER 50 (97-00)-POGGIALI 50 (2002)-PUREJET 50 (02-04)-SP 50 (02-04) SP 50 (02-04) RUNNER FX-FXR 125-180 (97-02)-VX-VXR 125-180 (00-01)-VX-VXR 125-200 TYPHOON 2T EU3 CH 50 (2011) - 2T EU2 50 (10-16) - 2T EU4 50 (2018) - 4T 2V EU3 125 (10-11)



ART. **6212**

BLOCCHETTO ON-OFF

(Sim.297777-178592)

**PIAGGIO:**

HEXAGON 125-150 (94-97)-NRG 50 (94-96)-EXTREME 50 (99-00)-MC3 50 (01-04) PUREJET 50 (02-04)-RST MC2 50 (96-98)-NTT 50 (95-96)-VELOFAX 50 (96-99) VESPA PX 30 ANNI 125 (07-08) - PX 125/150 (11-17) ZIP 50 (92-96)-BIMODALE 50 (94-97)-F.R.50 (93-94)-F.R. RST 50 (96-97)-RST 50/SP 50 (96-00) VESPA N 50 (89-90)-PK 50-125 (82-84)-PKS 50-125 AUTOMATICA (84-89)-PK XL 50 (85-88) VESPA PK XL 125 (86-89) - RUSH 50 (88-89)-PX 125-150-200 (98-01)-PX EU2 125 (01-02) VESPA PXE ARCOBALENO 125-150-200 (81-97)-T5 125(85-89)-APE FL-FL2 50 (89-95)

**GILERA:**

EASY MOVING 50 (95-96)-STALKER 50 (97-08)-NAKED 50 (08)-SPEC.EDIT.(07-08) STORM 50 - TYPHOON 50 (94-97/01-08) - X 50 (98-99)-XR 50 (2000) -125 (95-98)-X-XR 125 (99-00)



ART. **6213-P**

BLOCCHETTO ON-OFF

(Sim.254536)

**PIAGGIO:**

FREE 50 (92-94)-FREE DELIVERY 50 (00-01) - FREE FL 50 (95-02) SFERA 50 (91-93) - SKIPPER 125-150 (94-97)-SKR CITY 80 (1999) VESPA COSA 2 125-150-200 (91-97) - VESPA FL 50 (1990)-FL 125 (89-90) VESPA FL2 AUTOMATICA 50 (90-91) - VESPA FL2 HP 50 (91-97)



## BLOCCHETTI AVVIAMENTO

### IGNITION SWITCHES

#### APRILIA



#### ART. **7303-K3**

KIT (N. 3 PZ.)

(Sim. 8201846)

BLOCCHETTO AVVIAMENTO +  
SERRATURA BAULETTO +  
SERRATURA SELLA

*KIT (No. 3 PCS)*  
IGNITION SWITCH + TOP BOX LOCK + SADDLE LOCK

SCARABEO 50 ('93-'05)  
SCARABEO STREET 50 ('05-'06)  
SCARABEO STREET 2T RST 50 ('06-'09)



#### ART. **7304-K3**

KIT (NR. 3 PZ)

(Sim. 8202452)

BLOCCHETTO AVVIAMENTO +  
SERRATURA BAULETTO +  
SERRATURA SELLA

*KIT (No. 3 PCS)*  
IGNITION SWITCH + TOP BOX LOCK + SADDLE LOCK

SCARABEO STREET 2T RESTYLING 50 ('06-'09)  
SCARABEO 50 2T NET ('09)  
SCARABEO 2T EU2 MOTORI/ENGINE PIAGGIO ('10-'12)  
SCARABEO 2T 50 ('14)



#### ART. **7302-K4**

KIT (NR. 4 PZ)

(Sim. 85180-R  
AP.8202329)

BLOCCHETTO AVVIAMENTO  
SERRATURA BAULETTO +  
SERRATURA SELLA

*KIT (No. 4 PCS)*  
IGNITION SWITCH + TOP BOX LOCK + SADDLE LOCK

SCARABEO 4T RST EU3 50 ('06-'09)  
SCARABEO 4T 4V 50 ('10-'12)  
SCARABEO 4T 4V NET 50 ('09-'10)  
SCARABEO 4T RST 100 ('06-'09)  
SCARABEO 4T NET 100 ('09-'12)  
SCARABEO 4T NET EU3 100 (2010)





## BLOCCHETTI AVVIAMENTO IGNITION SWITCHES

### KYMCO



ART. **7324-K3**

KIT (N. 3 PZ.)

(Sim. 00169307)

BLOCCHETTO AVVIAMENTO +  
SERRATURA BAULETTO +  
SERRATURA SELLA

*KIT (No. 3 PCS)*

IGNITION SWITCH + TOP BOX LOCK + SADDLE LOCK

PEOPLE 50 ('99-'04)  
PEOPLE 125-150 ('99-'00)  
PEOPLE EU2 50 ('03-'11)  
PEOPLE EU2 125-150 (2003)  
PEOPLE EU3 125 ('07-'11)



ART. **7325-K2**

KIT (NR. 2 PZ.)

(Sim. 00169146)

BLOCCHETTO AVVIAMENTO +  
SERRATURA BAULETTO

*KIT (No. 2 PCS)*

IGNITION SWITCH + TOP BOX LOCK

X CITING 250 (2005)  
X CITING I 250 ('06-'07)  
X CITING 300I 300 (2008)  
X CITING 300I R 300 ('08-'09)  
X CITING 500 (2005)  
X CITING 500I 500 ('06-'08)  
X CITING 500I R 500 ('07-'08)  
X CITING 500 R 500 (2009)

### HONDA



ART. **7313-K3**

KIT (N. 3 PZ.)

(Sim. 35010-KTF720)

BLOCCHETTO AVVIAMENTO +  
SERRATURA BAULETTO +  
SERRATURA SELLA

*KIT (No. 3 PCS)*

IGNITION SWITCH + TOP BOX LOCK + SADDLE LOCK

SH 125/150 ('01-'08)

## BLOCCHETTI AVVIAMENTO

### IGNITION SWITCHES

#### MALAGUTI

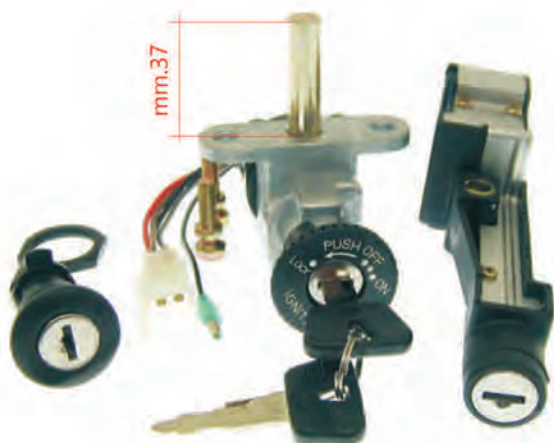

ART. **7291-K3**

KIT (N. 3 PZ.)

(Sim. 09002800)

BLOCCHETTO AVVIAMENTO +  
SERRATURA BAULETTO +  
SERRATURA SELLA

*KIT (No. 3 PCS)*  
*IGNITION SWITCH + TOP BOX LOCK + SADDLE LOCK*

CROSSER CR1 ('95-'98)  
F12 ARIA/LC RESTYLING EU2 50 ('06)  
F12 PHANTOM 50 ('94-'98)  
F12 PHANTOM 100 ('99-'00)  
F12 PHANTOM EURO1 50 ('99-'00)  
F12 PHANTOM LC 50 ('94-'98)  
F12 PHANTOM LC EU1 50 ('99-'00)  
F12 LC RST EU1 50 ('01-'02)  
F12 PHANTOM LC RST EU2 50 ('02)  
F12 LC RST EU2-3 50 ('03-'04)  
F12 PHANTOM LC TWIN DISKS 50 ('98)  
F12 PHANTOM RST EU1 50 ('01-'02)  
F12 PHANTOM RST EU2 50 ('02)  
F12 PHANTOM RST EU2-EU3 50 ('03-'04)

#### MBK - YAMAHA



ART. **7278-K2**

KIT (N. 2 PZ. )

(Sim. 4FWH20210200)

BLOCCHETTO AVVIAMENTO +  
SERRATURA SELLA

*KIT (No. 2 PCS) IGNITION SWITCH + SADDLE LOCK*

MBK BOOSTER 50 ('90-'02)  
MBK BOOSTER ROAD 50 ('94-'95)-  
MBK SPIRIT 50 ('96-'00)  
MBK SPIRIT EU2 50 ('02)

YAMAHA BW'S ORIGINAL EU2 50 ('02)





SCOOTER

**DELLORTO**

# carburettori e ricambi

*Carburetors and Spare Parts*



# DELLORTO

## CARBURATORI

### CARBURETORS

**DIFFUSORE Ø mm.12**



ATTACCO MANICOTTO  
AL MOTORE Ø mm. 24  
GETTO MASSIMO 72  
CIF art. 12072

ART. **12243**

PHVA 12 QD

(DELL. 8348)

**SPECIFICO**

PIAGGIO 50 cc.  
ZIP ('98) - ZIP FAST RAIDER - ZIP RST ('97->)

- ATTACCO MIX
- ATTACCO DEPRESSORE
- TRASMISSIONE COMANDO GAS
- PREDISPOSIZIONE RISCALDAMENTO AD ACQUA
- STARTER ELETTRICO APPLICATO

- / CONNECTION MIXER*
- / CONNECTION DEPRESSOR*
- / THROTTLE SHIFT TRANSMISSION*
- / PREDISPOSITION HEATING TO WATER*
- / ELECTRIC STARTER APPLIED*



ATTACCO MANICOTTO  
AL MOTORE Ø mm. 24  
GETTO MASSIMO 70  
CIF art. 12070

ART. **12244**

PHVA 12 QD

(DELL. 8330)

**SPECIFICO**

PIAGGIO NRG - NTT  
GILERA TYPHOON - STORM

- ATTACCO MIX
- ATTACCO DEPRESSORE
- TRASMISSIONE COMANDO GAS
- PREDISPOSIZIONE RISCALDAMENTO AD ACQUA
- STARTER ELETTRICO APPLICATO

- / CONNECTION MIXER*
- / CONNECTION DEPRESSOR*
- / THROTTLE SHIFT TRANSMISSION*
- / PREDISPOSITION HEATING TO WATER*
- / ELECTRIC STARTER APPLIED*



ATTACCO MANICOTTO  
AL MOTORE Ø mm. 24  
GETTO MASSIMO 58  
CIF art. 12058

ART. **12245**

PHVA 12 QD

(DELL. 8402)

**GENERICO**

PIAGGIO - GILERA

- ATTACCO MIX
- ATTACCO DEPRESSORE
- TRASMISSIONE COMANDO GAS
- PREDISPOSIZIONE RISCALDAMENTO AD ACQUA
- STARTER ELETTRICO APPLICATO

- / CONNECTION MIXER*
- / CONNECTION DEPRESSOR*
- / THROTTLE SHIFT TRANSMISSION*
- / PREDISPOSITION HEATING TO WATER*
- / ELECTRIC STARTER APPLIED*





**CARBURATORI**  
CARBURETORS

**DELLORTO**

**DIFFUSORE Ø mm.12**



ATTACCO MANICOTTO  
AL MOTORE Ø mm. 24  
GETTO MASSIMO 93  
CIF art. 12093

ART. **12247**

PHBN 12 HS

(DELL. 3046)

**SPECIFICO**

MBK BOOSTER

- ATTACCO MIX
- ATTACCO DEPRESSORE
- TRASMISSIONE COMANDO GAS
- PREDISPOSIZIONE RISCALDAMENTO AD ACQUA
- STARTER ELETTRICO APPLICATO

*/ CONNECTION MIXER  
/ CONNECTION DEPRESSOR  
/ THROTTLE SHIFT TRANSMISSION  
/ PREDISPOSITION HEATING TO WATER  
/ ELECTRIC STARTER APPLIED*



ATTACCO MANICOTTO  
AL MOTORE Ø mm. 24  
GETTO MASSIMO 74  
CIF art. 12074

ART. **12249**

PHVA 12 PS

(DELL. 1391)

**SPECIFICO**

MALAGUTI F 12 PHANTOOM ('96)

- ATTACCO MIX
- ATTACCO DEPRESSORE
- TRASMISSIONE COMANDO GAS
- PREDISPOSIZIONE RISCALDAMENTO AD ACQUA
- STARTER ELETTRICO APPLICATO

*/ CONNECTION MIXER  
/ CONNECTION DEPRESSOR  
/ THROTTLE SHIFT TRANSMISSION  
/ PREDISPOSITION HEATING TO WATER  
/ ELECTRIC STARTER APPLIED*



ATTACCO MANICOTTO  
AL MOTORE Ø mm. 24  
GETTO MASSIMO 76  
CIF art. 12076

ART. **12250**

PHBN 12 GS

(DELL. 3069)

**SPECIFICO**

APRILIA SCARABEO 50 ('96)

**GENERICO**

MOTORI MINARELLI 50 cc.

- ATTACCO MIX
- ATTACCO DEPRESSORE
- TRASMISSIONE COMANDO GAS
- PREDISPOSIZIONE RISCALDAMENTO AD ACQUA
- STARTER ELETTRICO APPLICATO

*/ CONNECTION MIXER  
/ CONNECTION DEPRESSOR  
/ THROTTLE SHIFT TRANSMISSION  
/ PREDISPOSITION HEATING TO WATER  
/ ELECTRIC STARTER APPLIED*

# DELLORTO

## CARBURATORI CARBURETORS

**DIFFUSORE Ø mm.17,5**



ATTACCO MANICOTTO  
AL MOTORE Ø mm. 24  
GETTO MASSIMO 65  
CIF art. 12065



ART. **12234** PHVA 17,5 ED (DELL. 1012)  
MOTORI PIAGGIO - GILERA

- |                                     |  |                                   |
|-------------------------------------|--|-----------------------------------|
| <input checked="" type="checkbox"/> | ATTACCO MIX                            | / CONNECTION MIXER                |
| <input checked="" type="checkbox"/> | ATTACCO DEPRESSORE                     | / CONNECTION DEPRESSOR            |
| <input type="checkbox"/>            | TRASMISSIONE COMANDO GAS               | / THROTTLE SHIFT TRANSMISSION     |
| <input type="checkbox"/>            | PREDISPOSIZIONE RISCALDAMENTO AD ACQUA | / PREDISPOSITION HEATING TO WATER |
| <input type="checkbox"/>            | STARTER ELETTRICO APPLICATO            | / ELECTRIC STARTER APPLIED        |



ATTACCO MANICOTTO  
AL MOTORE Ø mm. 24  
GETTO MASSIMO 110  
CIF art. 12110



ART. **12227** PHBN 17,5 LS (DELL. 3067)  
MOTORI MINARELLI - YAMAHA  
MBK BOOSTER .....

- |                                     |  |                                   |
|-------------------------------------|--|-----------------------------------|
| <input checked="" type="checkbox"/> | ATTACCO MIX                            | / CONNECTION MIXER                |
| <input checked="" type="checkbox"/> | ATTACCO DEPRESSORE                     | / CONNECTION DEPRESSOR            |
| <input type="checkbox"/>            | TRASMISSIONE COMANDO GAS               | / THROTTLE SHIFT TRANSMISSION     |
| <input checked="" type="checkbox"/> | PREDISPOSIZIONE RISCALDAMENTO AD ACQUA | / PREDISPOSITION HEATING TO WATER |
| <input type="checkbox"/>            | STARTER ELETTRICO APPLICATO            | / ELECTRIC STARTER APPLIED        |



ATTACCO MANICOTTO  
AL MOTORE Ø mm. 24  
GETTO MASSIMO 80  
CIF art. 12080



ART. **12246** PHVA 17,5 TS (DELL. 1389)  
MALAGUTI F 10 - F12

- |                                     |  |                                   |
|-------------------------------------|--|-----------------------------------|
| <input checked="" type="checkbox"/> | ATTACCO MIX                            | / CONNECTION MIXER                |
| <input checked="" type="checkbox"/> | ATTACCO DEPRESSORE                     | / CONNECTION DEPRESSOR            |
| <input type="checkbox"/>            | TRASMISSIONE COMANDO GAS               | / THROTTLE SHIFT TRANSMISSION     |
| <input checked="" type="checkbox"/> | PREDISPOSIZIONE RISCALDAMENTO AD ACQUA | / PREDISPOSITION HEATING TO WATER |
| <input type="checkbox"/>            | STARTER ELETTRICO APPLICATO            | / ELECTRIC STARTER APPLIED        |



INTERASSE FORI ATTACCO  
mm. 42,5  
GETTO MASSIMO 90  
CIF art. 12090



ART. **12233** PHVA 17,5 US (DELL. 1438)  
HONDA SKY - X8R - SFX - SGX





**CARBURATORI**  
CARBURETORS

**DELLORTO**

**DIFFUSORE Ø mm.19**



ATTACCO MANICOTTO  
AL MOTORE Ø mm. 24  
GETTO MASSIMO 85  
CIF art. 11085

ART. **12282**

PHBG 19 BS

MOTORI / ENGINE MINARELLI-YAMAHA  
SCOOTER

- ATTACCO MIX
- ATTACCO DEPRESSORE
- TRASMISSIONE COMANDO GAS
- PREDISPOSIZIONE RISCALDAMENTO AD ACQUA
- STARTER ELETTRICO APPLICATO

- / CONNECTION MIXER
- / CONNECTION DEPRESSOR
- / THROTTLE SHIFT TRANSMISSION
- / PREDISPOSITION HEATING TO WATER
- / ELECTRIC STARTER APPLIED



PARTICOLARE POLVERIZZATORE SENZA FORELLINI  
PARTICULAR PULVERIZER WITHOUT HOLES



ATTACCO MANICOTTO  
AL MOTORE Ø mm. 24  
GETTO MASSIMO 75  
CIF art. 11075

ART. **12238-AE**

PHBG 19 DS

MOTORI / ENGINE MINARELLI-YAMAHA  
SCOOTER

- ATTACCO MIX
- ATTACCO DEPRESSORE
- TRASMISSIONE COMANDO GAS
- PREDISPOSIZIONE RISCALDAMENTO AD ACQUA
- STARTER ELETTRICO APPLICATO

- / CONNECTION MIXER
- / CONNECTION DEPRESSOR
- / THROTTLE SHIFT TRANSMISSION
- / PREDISPOSITION HEATING TO WATER
- / ELECTRIC STARTER APPLIED



ART. **12283**

PHBG 19 DS

MOTORI "2 TEMPI" / "2 STROKE" ENGINE  
MINARELLI-YAMAHA SCOOTER

**CARATTERISTICHE TECNICHE**

Corpo carburatore di colore nero verniciato

Diffusore : 19

Coperchio valvola gas in alluminio avvitato

Attacco Miscelatore

Attacco presa pressione

Sistema del minimo con getto e vite regolazione miscela

Sistema del massimo con regolazione meccanica della miscela a mezzo spillo conico

Vaschetta in alluminio con tappo centrale per smontaggio rapido del getto

Attacco per montaggio elastico 25 mm.

Attacco presa aria M32 x 1,25 per montaggio cornetti e raccordi

**DELLORTO**

**CARBURATORI**  
CARBURETORS

**DIFFUSORE Ø mm.20,5**



ATTACCO MANICOTTO  
AL MOTORE Ø mm. 29  
GETTO MASSIMO 82  
CIF art. 12082

ART. **12259**

PHVB 20.5 ED

**SPECIFICO**

PIAGGIO SKIPPER LX - LXT 125-150 ('99)  
GILERA TYPHOON 125 CAT. ('99)

- ATTACCO MIX
- ATTACCO DEPRESSORE
- TRASMISSIONE COMANDO GAS
- PREDISPOSIZIONE RISCALDAMENTO AD ACQUA
- STARTER ELETTRICO APPLICATO

- / CONNECTION MIXER
- / CONNECTION DEPRESSOR
- / THROTTLE SHIFT TRANSMISSION
- / PREDISPOSITION HEATING TO WATER
- / ELECTRIC STARTER APPLIED



ART. **12280**

**KIT ALIMENTAZIONE PERFORMANTE**

CON CARBURATORE DIFFUSORE Ø mm. 20,5

ATTACCO ELASTICO  
BOCCHETTONE DIAMETRO mm. 29  
ATTACCO DEPRESSORE - ATTACCO MISCELATORE  
REGOLAZIONE DESTRA

COMPLETO DI KIT COPERCHIO STARTER A FILO  
**+ SPILLO CONICO E POLVERIZZATORE RACING**

**PERFORMANCE POWER KIT**

CARBURETOR WITH DIFFUSER DIAMETER mm.20,5

ELASTIC CONNECTION  
UNION PIPE DIAMETER mm. 29  
DEPRESSOR CONNECTION - MIXER CONNECTION  
RIGHT REGULATION

COMPLETE WITH WIRE STARTER COVER KIT  
**+ TAPERED NEEDLE AND RACING PULVERIZER**

ARTICOLO DESTINATO PER USO AGONISTICO SU PISTA  
ITEM INTENDED FOR COMPETITIVE USE ON THE TRACK





**CARBURATORI**  
CARBURETORS

**DELLORTO**

**DIFFUSORE Ø mm.21**



ATTACCO MANICOTTO  
AL MOTORE Ø mm. 24  
GETTO MASSIMO 92  
CIF art. 11092

ART. **12239-AE** PHBG 21 DS

MOTORI / ENGINE MINARELLI-YAMAHA  
SCOOTER

- |                                     |  |                                   |
|-------------------------------------|--|-----------------------------------|
| <input type="checkbox"/>            | ATTACCO MIX                            | / CONNECTION MIXER                |
| <input checked="" type="checkbox"/> | ATTACCO DEPRESSORE                     | / CONNECTION DEPRESSOR            |
| <input type="checkbox"/>            | TRASMISSIONE COMANDO GAS               | / THROTTLE SHIFT TRANSMISSION     |
| <input checked="" type="checkbox"/> | PREDISPOSIZIONE RISCALDAMENTO AD ACQUA | / PREDISPOSITION HEATING TO WATER |
| <input type="checkbox"/>            | STARTER ELETTRICO APPLICATO            | / ELECTRIC STARTER APPLIED        |



ART. **12285** PHBG 21 DS

MOTORI " 2 TEMPI " / " 2 STROKE " ENGINE  
MINARELLI-YAMAHA SCOOTER

**CARATTERISTICHE TECNICHE**

Corpo carburatore di colore nero verniciato - Diffusore : 21

Coperchio valvola gas in alluminio avvitato

Attacco Miscelatore

Attacco presa pressione

Sistema del minimo con getto e vite regolazione miscela

Sistema del massimo con regolazione meccanica della miscela a mezzo spillo conico

Vaschetta in alluminio con tappo centrale per smontaggio rapido del getto

Attacco per montaggio elastico 25 mm.

Attacco presa aria M32 x 1,25 per montaggio cornetti e raccordi

# DELLORTO

## CARBURATORI

### CARBURETORS

**DIFFUSORE Ø mm.24**



ART. **12272**

**STANDARD**

PHBL 24 BS (DELL. 2724)

ADATTABILE VESPA E SCOOTER

ATTACCO ELASTICO Ø mm. 31

Getto massimo 100 (CIF art. 12100)

Getto minimo 50 (CIF art. 11050)



ART. **12273-4T**

**STANDARD**

PHBL 24 AD (DELL. 2716)

ADATTABILE VESPA E SCOOTER  
MOTORI **4TEMPI / STROKE**

ATTACCO RIGIDO da Ø mm.31,75 a Ø mm.28,57

Getto massimo 110 (CIF art. 12110)

Getto minimo 50 (CIF art. 11050)



ART. **12276**

PHBL 24 AS (DELL. 2715)

ADATTABILE VESPA

ATTACCO RIGIDO Ø mm. 28,5  
REGOLAZIONE SINISTRA

Getto massimo 100 (CIF art. 12100)

Getto minimo 50 (CIF art. 11050)



ART. **12275**

PHBL 24 AD (DELL. 2733)

ADATTABILE VESPA

ATTACCO RIGIDO Ø mm. 28,5  
REGOLAZIONE DESTRA

Getto massimo 100 (CIF art. 12100)

Getto minimo 50 (CIF art. 11050)



ART. **12275-M**

PHBL 24 BD (DELL. 2762)

ADATTABILE VESPA

ATTACCO ELASTICO Ø mm. 31  
REGOLAZIONE DESTRA  
ATTACCO MISCELATORE

Getto massimo 95 (CIF art. 12095)

Getto minimo 50 (CIF art. 11050)





## SPILLI CHIUSURA BENZINA NEEDLES

**DELLORTO**



ART. **11498**

SPILLO TRIANGOLARE TESTINA TONDA PICCOLA Ø mm. 2,5 (DELL. 15304.05)  
**MOLLA MORBIDA**

*TRIANGULAR - SMALL ROUND HEAD Ø mm. 2.5 - SOFT SPRING*

PER CARBURATORI PHVA 17,5 TS .. - US ...

MALAGUTI F10 - F12 - HONDA SKY - X8R - SFX - SGX



ART. **11503**

SPILLO TRIANGOLARE MOLLEGGIATO (DELL. 11668)  
**TESTINA TONDA GROSSA Ø mm. 3,5**

*TRIANGULAR, SPRINGY - BIG ROUND HEAD Ø mm. 3,5*

PER CARBURATORI PHBN - PHVA - PHVB

PIAGGIO SCOOTER

### PER CARBURATORI PHBN - PHVA - PHVB

SCOOTER PIAGGIO-GILERA 50-125-150-180 cc.  
MOTORI MINARELLI YAMAHA



ART. **11503-A**

SPILLO TRIANGOLARE E MOLLEGGIATO MODIFICATO (DELL. 15360)  
**CON TESTINA TONDA PICCOLA Ø mm. 2,5**

*TRIANGULAR SPRINGY NEEDLE,  
MODIFIED WITH SMALL ROUND HEAD Ø mm. 2.5*

PER CARBURATORI PHBN - PHVA - PHVB



ART. **11503-KT**

KIT GALLEGGIANTE+SPILLO TRIANGOLARE E MOLLEGGIATO (DELL.53053-78)  
**MODIFICATO CON TESTINA TONDA PICCOLA Ø mm. 2,5**

*KIT OF FLOAT AND TRIANGULAR SPRINGY NEEDLE,  
MODIFIED WITH SMALL ROUND HEAD Ø mm. 2.5*

PER CARBURATORI PHBN - PHVA - PHVB

**DELLORTO**

**GETTI PER CARBURATORI**  
CARBURETORS JETS

**GETTO TIPO PICCOLO FILETTO mm. 5**  
(DELLORTO 01486 ...)

Articolo	Variante
11040	40
11042	42
11044	44
11046	46
11048	48
11050	50
11051 (SPECIFICO VESPA 50)	51
11052	52
11054	54
11056	56
11058	58
11060	60
11062	62
11064	64
11066	66
11068	68
11070	70
11072	72
11074	74
11076	76
11078	78
11080	80
11082	82
11085	85
11087	87
11090	90
11092	92
11095	95
11098	98
11100	100
11102	102
11105	105
11108	108
11110	110
11112	112
11115	115
11118	118
11120	120
11122	122
11125	125
11130	130



Confezione minima  
10 pz.

**GETTO TIPO GROSSO FILETTO mm. 6**  
(DELLORTO 06413 ...)

Articolo	Variante
12054	54
12056	56
12058	58
12060	60
12062	62
12064	64
12066	66
12068	68
12070	70
12072	72
12074	74
12075	75
12078	78
12080	80
12082	82
12085	85
12088	88
12090	90
12092	92
12095	95
12098	98
12100	100
12102	102
12105	105
12107	107
12110	110
12112	112
12115	115
12118	118
12120	120
12125	125
12130	130
12135	135
12140	140
12145	145
12150	150
12155	155
12160	160
12165	165
12170	170



Confezione minima  
10 pz.

**GETTO MINIMO FILETTO mm. 5**  
(DELLORTO 01488 ...)

PER CARBURATORI  
SERIE PHBG - PHBD



Articolo	Variante
14040	40
14042	42
14045	45
14048	48
14050	50
14052	52
14055	55
14060	60

Confezione minima  
4 pz.

**GETTO AVVIAMENTO FILETTO mm. 5**  
(DELLORTO 07746 ...)

PER CARBURATORI  
SERIE PHBH-PHBL-PHS-PHM



Articolo	Variante
13800-45	45
13800-50	50
13800-55	55
13800-60	60
13800-65	65

Confezione minima  
2 pz.





## RICAMBI PER CARBURATORI CARBURETORS SPARE PARTS

**DELLORTO**

### VASCHELETTE CON GUARNIZIONE FLOAT CHAMBERS WITH GASKET



ART. **11553**

per carburatori:  
PHBG 19..- 20..-21..

SCOOTER  
CICLOMOTORI  
MOTO VARIE

(DELL. 9444.96)



ART. **11554**

per carburatori:  
PHVA - PHBN - 16..-17,5 ..

PIAGGIO SFERA  
MBK BOOSTER

(DELL. 13678.96)



ART. **11555**

per carburatori:  
PHVB.. - PHVA - 22..

SCOOTER

(DELL. 14363.96)



ART. **11556**

per carburatori:  
PHVB..18 - 20,5 - 22

SCOOTER  
PIAGGIO 125-150-180 cc.

(DELL. 15354.96)



ART. **11557**

per carburatori:  
PHVA 17,5 TS

MALAGUTI F10 - F12

(DELL. 14699.96)

### VALVOLE GAS FLOAT CHAMBERS THROTTLE VALVES



ART. **11512**

per carburatori:  
PHBG 15 -16 - 17 -18 - 19 - 20 -21

con e senza MIX  
with and without MIX

(DELL. 9475.40)



ART. **11513**

per carburatori:  
PHVA 12 ...

PIAGGIO SCOOTER

(DELL. 13685.40) (Var. 40)



ART. **11651**

per carburatori:  
PHBN 17,5

MOTORI / ENGINE  
MINARELLI - YAMAHA

(DELL. 15362.64)

### VITI FISSAGGIO VASCHELETTE SCREWS FIX FLOAT CHAMBERS



ART. **11559**

per carburatori:  
PHBG 19 - 20 - 21 ..

SCOOTER

(DELL. 11836.36)



ART. **11561**

per carburatori:  
PHVA - PHVB

SCOOTER

(DELL. 13709.36)

**DELLORTO**

RICAMBI PER CARBURATORI  
CARBURETORS SPARE PARTS

**KIT STARTER AUTOMATICO**

AUTOMATIC STARTER KIT



ART. **11642**

STARTER AUTOMATICO **(FILO LUNGO)**  
AUTOMATIC STARTER **(LONG WIRE)**

per carburatori PHVA SCOOTER PIAGGIO  
per carburatori PHBN SCOOTER APRILIA

(DELL. 53078 )



ART. **11643**

STARTER AUTOMATICO **(FILO CORTO)**  
AUTOMATIC STARTER **(SHORT WIRE)**

per carburatori PHVA - PHBN

SCOOTER TUTTI MOTORI MINARELLI - MORINI

(DELL. 53081 )

**DISPOSITIVI STARTER MANUALE COMPLETO**

COMPLETE MANUAL STARTER KIT



Ø mm. 8

ART. **11637**

per carburatori PHBG TUTTI TIPI / ALL TYPE

(BARILOTTO ARIA Ø mm.8) (AIR PAWL Ø mm.8)



Ø mm. 7

ART. **11639**

per carburatori PHBN 17,5 - SHBC 19

(BARILOTTO ARIA Ø mm.7) (AIR PAWL Ø mm.7)





**RICAMBI PER CARBURATORI**  
CARBURETORS SPARE PARTS

**DELLORTO**



ART. **11638**

KIT MODIFICA **STARTER A LEVA**  
MODIFIED LEVER STARTER KIT

(BARILOTTO ARIA / AIR PAWL Ø mm.7)

per carburatori PHVA  
SCOOTER



ART. **11636**

KIT MODIFICA **STARTER A FILO**  
MODIFIED THREAD STARTER KIT

(BARILOTTO ARIA / AIR PAWL Ø mm.8)

per carburatori PHBG .....

sostituisce lo starter manuale sul carburatore  
*replace manual starter on carburettor*



ART. **11640-CU**

KIT MODIFICA **STARTER A FILO**  
MODIFIED THREAD STARTER KIT

(BARILOTTO ARIA / AIR PAWL Ø mm.7)

per carburatori PHVA - PHBN - PHVB  
SCOOTER

riabilita il carburatore da starter elettrico a starter manuale  
*restore carburettor from electric starter to manual starter*



ART. **11641-V**

KIT **STARTER A FILO**  
THREAD STARTER KIT

(BARILOTTO ARIA Ø mm.7) (USCITA VERTICALE)  
(AIR PAWL Ø mm.7) (VERTICAL OUT)

per carburatori PHBN 17,5 - SHBC

riabilita il carburatore da starter elettrico a starter manuale  
*restore carburettor from electric starter to manual starter*

**DELLORTO**

**RICAMBI PER CARBURATORI**  
CARBURETORS SPARE PARTS



ART. **11641**

KIT COPERCHIO **STARTER A FILO**  
THREAD STARTER COVER KIT

(CURVA A 90°+70°) (BARILOTTO ARIA Ø mm.7)  
(CURVE 90°+70°) (AIR PAWL Ø mm.7)

per carburatori PHBN 12 - 14 - 16 - 17,5



ART. **11630-70**

KIT CURVA GUIDAFILO 70° (CURVE 70°+60°)  
CURVE THREAD GUIDE KIT

per carburatori PHBG .....



ART. **11630-90**

KIT CURVA GUIDAFILO 90°  
CURVE THREAD GUIDE KIT

per carburatori PHBG .....



ART. **10262-A**

COMANDO **STARTER ANULARE** AL MANUBRIO  
RING CONTROL STARTER TO HANDLEBAR

SCOOTER - MOTO



ART. **10262-L**

KIT **STARTER A LEVA**  
PER FISSAGGIO SU CARTER MOTORE  
(COMPLETO DI FASCETTA PER IL FISSAGGIO)  
KIT STARTER LEVER FOR FIXING ON CARTER  
(WITH CLAMP FOR FIX)

SCOOTER - MOTO





**SERIE GUARNIZIONI REVISIONE**  
CARBURETORS REVISION GASKET SET

**DELLORTO**



ART. **11625**

per carburatori: PHBG 19 - 20 - 21 A - B

PER VARIE APPLICAZIONI / FOR GENERIC APPLICATION

(DELL.52626)

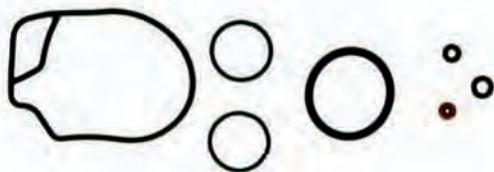

ART. **11618**

per carburatori: PHVA 17,5 US - TS .....

HONDA - MALAGUTI

(DELL.52625)

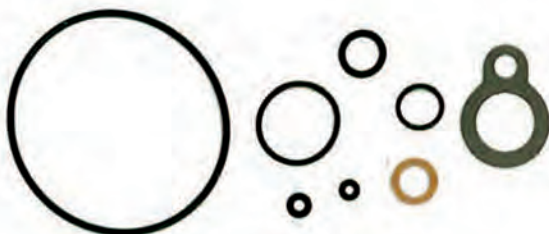

ART. **11628**

per carburatori: PHBN 16

MBK BOOSTER -APRILIAAMICO

(DELL.52620)



ART. **11629**

per carburatori: PHVA 12 - 17,5

SCOOTER

(DELL.52622)

## RACCORDI AMMISSIONE

### INLET PIPES



ART. **11660**

RACCORDO AMMISSIONE  
(Sim. 830939 ex 436095)

Ø INTERNO / INTERNAL mm. 22

INTERASSE FORI D'ATTACCO mm. 53  
WHEELBASE HOLES CONNECTION mm. 53

#### PIAGGIO GILERA 50 cc. 2 TEMPI/STROKE

##### PIAGGIO:

LIBERTY ('97-'05)-RST ('04)-PTT EU2 ('04-'05)-SPORT ('06)  
DIESIS ('01) - FLY ('05) - FREE ('92-'04) - FREE FL ('95-'02)  
FREE DELIVERY ('00-'01)-NRG ('94-'96)-RST MC2 ('96-'98)  
MC3('01-'04) - EXTREME ('99-'00) -NRG POWER DD ('06)  
NRG POWER DT ('06)-SFERA ('91-'93)-RST ('95-'97)  
SFERA MAQUILLAGE 2 ('94) - VESPA LX ('05)-LXV ('06)  
VESPA ET2 ('97-'05)-ZIP ('92-'94) - ZIP RST ('96-'99) - ZIP SP ('01-'04)

##### GILERA:

DNA ('05-'07) - DNA GP EXPERIENCE ('03-'04)-RUNNER SP ('05-'06)  
RUNNER SP SC ('06-'07)-RUNNER SP RACE ('06)-PUREJET ('02-'04)  
STALKER ('05-'06)-TYPHOON ('94-'97)-TYPHOON X ('98-'99)-XR ('00)



ART. **11662**

RACCORDO AMMISSIONE  
(Sim. 430206)

Ø INTERNO / INTERNAL mm. 27

INTERASSE FORI D'ATTACCO mm. 53  
WHEELBASE HOLES CONNECTION mm. 53

#### PIAGGIO GILERA 125-150-180 cc. 2 TEMPI/STROKE

##### PIAGGIO:

HEXAGON 125-150 ('94-'97) - HEXAGON LX - LXT 125-180 ('98-'99)  
SKIPPER 125-150 ('94-'97) - SKIPPER LX 125-150 ('98-'99)

##### GILERA:

RUNNER FX/FXR 125/180 ('97-'02)  
TYPHOON 125 ('95-'98) - TYPHOON X - XR 125('99-'00)



ART. **11663**

RACCORDO AMMISSIONE

Ø INTERNO / INTERNAL mm.27

INTERASSE FORI D'ATTACCO mm. 48  
WHEELBASE HOLES CONNECTION mm. 48

##### PIAGGIO:

LIBERTY 125 ('98-'00)  
VESPA ET4 125 ('96-'99)  
SFERA 125 ('95-'97)



ART. **11664**

RACCORDO AMMISSIONE  
(Sim. 485587)

Ø INTERNO / INTERNAL mm.33

INTERASSE FORI D'ATTACCO mm. 49  
WHEELBASE HOLES CONNECTION mm. 49

##### PIAGGIO:

LIBERTY 125-150 ('00-'02)  
SKIPPER 4T 125-150 ('00-'02)  
VESPA ET4 125-150 ('99-'02)  
ZIP 125 ('00-'02)



ART. **11665**

RACCORDO AMMISSIONE

Ø INTERNO / INTERNAL mm.21

#### MOTORI MINARELLI-YAMAHA CILINDRO ORIZZONTALE / HORIZONTAL CYLINDER

<b>APRILIA</b>	SCOOTER 50
<b>MALAGUTI</b>	CENTRO-SL BASE-F10 J.L-F12 H20-ARIA-F15
<b>MBK</b>	OVETTO - EVOLIS - FIZZ -FORTE -NITRO FLIPPER-KAT ('94-'01) (Sim.4CVE35550000)
<b>YAMAHA</b>	AEROX - R - WHY - KAT - BREEZE AXIS-NEO'S ('94-'01)





## MEMBRANE CARBURATORE

### CARBURETOR DIAPHRAGMS



ART. **11474**

MEMBRANA CARBURATORE

(Sim.CM140301)

**PIAGGIO:**

BEVERLY 250 (05-07) - EU3 125 (07-08) - EU3 MIC 125 (07)  
BEVERLY EU3 SPORT 125 (07-08)-RST 125 (05-07)-TOURER EU3 125 (07-10)  
CARNABY 125 (07-10) - CARNABY 200 (07-08) - MP3 125 (06-08) -  
VESPA GRANTURISMO 125 (03-07) - VESPA GRANTURISMO 125/ 200 (06-07)  
GRANTURISMO EU3 125 (06-07) - VESPA GTS EU3 125 (07-12)  
VESPA GTV 125 (06-08) - GTV 4T NAVY EU3 125 (2008) - X EVO 125 (07-16)  
X7 EU3 125 (2008)-X8 125 (05-06)-X8 200 (05-07)-X8 PREMIUM EU2 125 (2006)  
X8 PREMIUM EU3 125 (06-07)-X9 EVOLUTION 125 (05-06)-EVOLUTION 250 (04-06)  
X9 EVOLUTION EU3 125 (2007)

**APRILIA:**

ATLANTIC EU3 125 (10-12)  
SPORT CITY 125 (04-06)-SPORT CITY CUBE 125 (08-10)-SPORT CITY STREET 125 (2012)



ART. **11476**

MEMBRANA CARBURATORE

(Sim.CM140302)

**PIAGGIO:**

FLY 125/150 (05-07) - FLY EU3 125 (07-11) - FLY EU3 150 (08-11)  
LIBERTY 200 (2006)-4T 125 (06-07)-4T 2V EU3 125 (09-12)-4T EU3 125 (06-08)  
LIBERTY 4T EU3 150 (2008)-4T EU3 200 (06-08)-4T EU3 DELIVERY-SINGLE 125 (07-15)  
LIBERTY 4T EU3 DELIVERY-TNT-NEXIVE 125 (08-15) - SPORT 125/200 (2006)  
LIBERTY 4T SPORT EU3 125 (06-08)-4T SPORT EU3 150 (2008)-4T SPORT EU3 200 (06-07)  
LIBERTY MOC 4T EU3 150 (09-13)-RST 200 (2004)-RST PTT 125 (05-11)  
VESPA GRANTURISMO 125 (03-05)  
VESPA LX 125/150 (05-06)-LX 4T FL 125/150 (2009)-LX EU3 125/150 (06-08)  
VESPA LXV 4T EU3 125 (06-09)-LXV 4T NAVY EU3 125 (07-08)  
VESPA S 4T 150 (08-09) - VESPA S 4T EU3 125 (07-08)  
X8 STREET EU2 125/150 (06-08)

**APRILIA:**

MOJITO 125 (2008) - SPORT CITY ONE 4T EU3 125 (08-11) - SR MOTARD 125 (12-14)



ART. **11478**

MEMBRANA CARBURATORE

(Sim.478560)

**PIAGGIO:**

HEXAGON LX4 125 (98-99) - LIBERTY 125 (98-00) - SFERA 125 (95-97)  
VESPA ET4 125 (96-98)

**APRILIA:**

MOJITO RETRO-CUSTOM 125 (99-01)



ART. **11480**

MEMBRANA CARBURATORE

(Sim.CM129701)

**PIAGGIO:**

BEVERLY 125 (01-03) - BEVERLY RST 125/250 (04-05)  
HEXAGON GTX 125 (2000) - SUPER HEXAGON GTX 12 125 (01-02)  
VESPA GRANTURISMO 125 (03-05)  
X8 125 (2004)  
X9 125 (01-02) - X9 200 (02-03)-X9 AMALFI 180 (00-03)-X9 EVOLUTION 125/200 (2003)

**APRILIA:**

ATLANTIC 125 (03-05) - SCARABEO 125 (03-06) - SPORT CITY 125 (04-06)



## MEMBRANE CARBURATORE

### CARBURETORS DIAPHRAGMS



ART. **11482**

MEMBRANA CARBURATORE

(Sim.CM146601-828820)

**PIAGGIO:**

FLY 4T 50 (05-07) - FLY 4T & 25-30 KM/H 50 (08-11) - FLY 4T 2V 50 (13-15)  
 FLY 4T 2V 25-30KM-H 50 (12-17) - FLY 4T MOTORE CHN 50 (06-07)  
 LIBERTY 4T 50 (00-02/05-08) - LIBERTY 4T RST 50 (2004)  
 LIBERTY 4T DELIVERY - SINGLE 50 (10-14) - LIBERTY 4T DELIVERY TNT 50 (2009)  
 LIBERTY 4T PTT (DEU) 50 (07-12) - LIBERTY 4T PTT - DOUBLE - NEXIVE 50 (09-17)  
 LIBERTY 4T SPORT 50 (06-08) - LIBERTY MOC 4T & ELLE 50 (09-16)  
 VESPA ET4 50 (00-05) - VESPA LX 4T 50 (05-09)  
 VESPA PRIMAVERA 4T 2V 25 KM/H 50 (14-17) - VESPA SPRINT 4T 2V 25 KM/H 50 (14-17)  
 ZIP 4T 50 (00-05) - ZIP 4T 50 (06-13) - ZIP 4T 25KM-H 50 (06-16)

**APRILIA:**

SCARABEO 4T 50 (02-06)-SCAR.4T RESTYLING EU3 50 (06-09)-SPORT CITY ONE 4T 50 (08-10)



ART. **11484**

MEMBRANA CARBURATORE

(Sim. AP8106478)

**APRILIA:**

LEONARDO 125 (96-02) - LEONARDO ST 125 (01-04)



ART. **11486**

MEMBRANA CARBURATORE

**APRILIA:**

LEONARDO 250 (02-04)

(Sim.AP8106995)

**BENELLI:**

VELVET TOURING 250 (02-03)

(Sim.R18440431A0)

**MALAGUTI:**

MADISON S 250 (99-01)

(Sim.92302600)

**MBK**

KILIBRE 300 (2003)  
 SKYLINER 125/180 (2003) - SKYLINER 250 (00-03) - ABS 250 (2003)

(Sim.4HC143400100)

**YAMAHA**

VERSITY 300 (03-05)-MAJESTY 125E/180E (03-06)  
 MAJESTY 250 (96-98 / 00-03) - MAJESTY ABS 250 (2003)-DX 250 (1999)

(Sim.4HC143400100)



ART. **11488**

MEMBRANA CARBURATORE

**BENELLI**

VELVET 125/150 (99-01) - VELVET TOURING 125/150 (02-03)

(Sim.R18341211A0)

**MALAGUTI**

MADISON 125 (99-01) - R RESTYLING 125 (2002)  
 MADISON T 150 (99-01)

**MBK**

DOODO 125 (00-01) - DOODO 150 (01-02)  
 THUNDER 125/150 (01-02) - SKYLINER 125 (98-02)

(Sim.5DS1434A1000)

**YAMAHA**

TEO'S 125 (2000) - TEO'S 150 (01-02)  
 MAXSTER 125/150 (01-02) - MAJESTY 125 (98-02)

(Sim.5DS1434A1000)





## MEMBRANE CARBURATORE CARBURETOR DIAPHRAGMS



ART. **11490**

MEMBRANA CARBURATORE

(Sim.16111KGF91)

**HONDA:**

SH 125/150 (01-04)  
NES 125 @ (00-02)  
SES DYLAN 125 (02-06)



ART. **11492**

MEMBRANA CARBURATORE

(Sim.00105115)

**KYMCO:**

AGILITY 4T CARRY 50 (2011)  
AGILITY 4T R10 50 (06-08)  
AGILITY 4T R12 50 (07-08)  
AGILITY 4T R16 50 (08-09 / 2012)  
AGILITY PLUS 4T 50 (2014)  
AGILITY R12 50 (2005)  
SUPER 8 50 (2007)  
SUPER 8 4T 50 (09-13)



ART. **11494**

MEMBRANA CARBURATORE

(Sim.00105036)

**KYMCO:**

AGILITY 4T 125 (2006)  
AGILITY 4T EU3 125 (06-08)  
AGILITY CARRY 125 (2011)  
AGILITY PLUS 125 (2014)  
AGILITY R16 125 / 150 (08-09)  
DINK 125 EU3 125 (06-07)  
LIKE 125 (2009)  
LIKE LX 125 (2012)  
MOVIE 125 EU3 125/150 (06-07)  
MOVIE XL 125/150 EU2 125 (03-04)  
PEOPLE 125-150 EU2 125 (2003)  
PEOPLE EU3 125 (07-08 / 2011)  
PEOPLE S 125 / 200 (2005)  
PEOPLE S DD EU3 125 (07-08)  
SUPER 8 125 (2008)

## FILTRI ARIA

### AIR FILTERS

ART. **11702**      FILTRO ARIA      (Sim.8201583)

**APRILIA**  
SCARABEO 50 ('03-'05)



ART. **11778**      FILTRO ARIA      (Sim.8202249)

**APRILIA**  
SCARABEO 4T 50 ('02-'06)  
SCARABEO 4T-4V 50 ('10-'14)  
SCARABEO 4T 4V NET 50 ('09-'10)  
SCARABEO 4T RST Eu3 50 ('06-'09)  
SCARABEO 4T 100 ('01-'14)  
SCARABEO 4T NET 100 ('10)  
SCARABEO 4T RTS 100 ('06-'09)



ART. **11779**      FILTRO ARIA      (Sim.JC13721X92000)

**APRILIA**  
SCARABEO LIGHT 125-200 ('07-'09)



ART. **11740**      FILTRO ARIA      (Sim.8201683)

**APRILIA**  
AREA 51 50 ('98-'00)  
GULLIVER ARIA/H20 50 ('96-'98)  
RALLY ARIA 50 ('95-'03)  
RALLY H20 50 ('96-'99)  
SONYC 50 ('98-'07)  
SONYC GP 50 ('98-'08)  
SR 50 ('94-'96)  
SR H20 50 ('94-'96)  
ST STEALTH, RACING 50 ('97-'00)  
SR WWW 50 ('97-'01)







## FILTRI ARIA

### AIR FILTERS

ART. **11780**

FILTRO ARIA

(Sim.842093 - AP8577006)

#### APRILIA

ATLANTIC 125 (03-05) - ATLANTIC EU3 125 (06-12) - ATLANTIC 300 (10-11)  
MOJITO 125 (03-07)-SCARABEO 125 (04-06) - SCARABEO MOT. PIAGGIO - EU3 125 (06)  
SCARABEO LIGHT 250 (06-08) - LIGHT 300 (09-10) - SPORT CITY 125 (04-06)  
SPORT CITY EU3 125 (06-08) - SPORT CITY ONE 4T EU3 125 (08-11)  
SPORT CITY CUBE 125 (08-10) - CUBE 250 (08-12) - SPORT CITY STREET 125/300 (12)  
SR MOTARD 125 (12-14) - SR MAX 300 (11-14)

#### DERBI

BOULEVARD EU3 125/150 (04-07)-GP1 EU2 (06)-GP1 250 (06-07)-RAMBLA 125/250 (06-08)--RAMBLA 300 (10)

#### GILERA

NEXUS EU3 125 (07-08)-EU3 250 (06-07)-EU3 300 (08-11)-SP EU3 250 (06-07)-TYPHOON 4T 2V EU3 125 (10-11)

#### PIAGGIO

BEVERLY RST 125/250 (04-07)-EU3 125 (07-08)-SPORT EU3 125 (07-08)-SPORT 250 (06-08)-EU3 MIC 125/250 (07)  
BEVERLY IE EU3 250 (06-08)-CRUISER 250 (07-09)-CRUISER 300 (09-12) -TOURER EU3 125/250/300-CARNABY 125(07-10)-CARNABY 250 (08)  
LIBERTY 4T 125(06-07)-4T 2V EU3 125(09-12)-4T EU3 150(08)-SPORT 4T EU3 125 (06-08)-150 (08)-MP3 LT 250 (08-09)  
VESPA GRANTURISMO/EU3 125(06-07)-GT 60 EU3 250(06-07)-GTS EU3 125 (07-12)-GTS 250 (05-16)-GTS ABS 250 (05-12)  
VESPA GTS IE & TOURING 300 (12-16)-GTS SUPER 300 (08-15)-GTV SUPER SPORT 300 (10-13)-GTV 125/250(06-08)-GTV 4T 4V IE 300(10-13)  
VESPA GTV NAVY 4T EU3 125(08)-GTV NAVY 4T EU3 250(07)-GTV MONTENAPOLIONE 300 (10)-GTV SEI GIORNI IE E4 ABS(EMEA) 300 (17)  
X7 EU3 125/250(08) - X7 EVO IE EU3 300 (09-10) - X8 STREET EU2 125(06-07) - X8 STREET EU2 150 (06-08)



ART. **11770**

FILTRO ARIA

(Sim. 829258-AP8104878)

#### APRILIA

ATLANTIC 125 (03-05) - ATLANTIC 125 EU3 (10-12) - ATLANTIC 300 (10-11)  
ATLANTIC SPRINT 400- 500 (05-07) - SCARABEO LIGHT 300 (09-10)  
SCARABEO LIGHT 400-500 (96-08) - SCARABEO SPORT CITY EU3 125 (06-08)  
SPORT CITY CUBE 125 (08-10) - SPORT CITY CUBE 250 (08-12)  
SPORT CITY STREET 125/300 (12) SR MAX 125/300 (11-14)

#### DERBI

RAMBLA 125/250(08)-GP1 EU2 125/250(06-07) - GP1 L.SEAT EU3 125/250(07-08)

#### GILERA

FUOCO 500(07-09)-FUOCO EU3 500(07-13)-NEXUS EU3 125(07-08)-EU3 250(06-07)  
NEXUS EU3 300 (08)-300IE (09)-SP EU3 250 (06-07) - RUNNER VX 125 (05-06)-VX 4T EU3 125 (07)-VX 4T ST EURO3 125 (08-13)-VX RACE 125 (06)  
RUNNER VX-VXR 125-200 (02-04) - VXR 200 (05-06) - VXR 4T ST EU3 200 (08) - VXR EU3 200 (07) - RACE 200 (06)

#### MALAGUTI

MADISON 125/250(06-09)-S RST 200(02)-S RST EU2 200(03) - MADISON RS RST (04) - PHANTOM MAX 200 (03) - PHANTOM MAX 250 (04)

#### PEUGEOT

GEO RS 250/400 (08-09) - GEOPOLIS 400/500 (07-09) - SATELIS 250-400-500(07-09)

#### PIAGGIO

BEVERLY 125(01-03)-250(06-07)-500(02-06)-IE EU3 250(06-08)-RST 125(04-07)-RST 250(04-05)-RST 4T 4V IE U3 125/300(10-15)- EU3 125 (07-08)  
BEVERLY EU3 400/500(06-07)-MIC EU3 125/250(07)-CRUISER 250(07-09)-CRUISER 500(07-12) - SPORT EU3 125 (07-08)-SPORT 250(06-08)  
BEVERLY TOURER EU3 125(07-10)-TOURER EU3 250(07-09) - TOURER 300 EU3 300 (09-10)-TOURER 400 (08-10)-IE ABS E4 (EMEA) 300(16-19)  
CARNABY 125 (07-10) - CARNABY 200(07-08)-250 (08)-CRUISER 300 (09-12) - MP3 400 (07-08) - HPE E4 ABS-SPORT 300(19)-IE E4 LT BUSINESS-SPORT  
ABS 300(16-18)-MP3 IE LT-IE LT SPORT 400 (08-10)-IE LT TOURING 400 (2011)-LT BUSINESS ABS 500(14-16)-LT BUSINESS- PORT ABS-ENJOY 300(14-16)  
MP3 LT E4 SPORT-BUSINESS 500(16-18)-LT SPORT-BUSINESS 500 (11-13)-RL TOURING 400 (2011) - MAXI SPORT-BUSINESS E4 ABS 500 (2018)  
MP3 MIC 400 (08-10)-RL SPORT-BUSINESS 500 (11-12) - SPORT ABS 500 (14-16) - YOURBAN ERL 125 (11-13) - YOURBAN ERL 300(11-15)  
MP3 -YOURBAN LT ERL 300(11-16)-YOUR.LT RL E4 300(17-18)-EVO 400 (07-11) - X7 EU3 125/250 (08) - X7 EVO IE EU3 125/300 (09-10)  
X8 EU3 400 (06-08) - X9 200 (02-03) - X9 EVOLUTION 125/200 (03)-X9 EVOL.250 (04) - X 10 4T 4V IE EU3 125 (12-15) - X10 4T 4V IE EU3 500 (12-14)



ART. **11705-RST**

FILTRO ARIA

(Sim. 436478)

#### BENELLI

ADIVA 125-150 (01-02)

#### ITALJET

TORPEDO 125-150 - VELOCIFERO 50

#### PIAGGIO

LIBERTY 125 (98-00) - HEXAGON LX4 125 (98-99)  
SFERA RST 50 (95-97) - SFERA 125 (95-97)  
VESPA ET2 50 (97-05) - VESPA ET2 INIEZIONE 50 (97-00) VESPA ET4 125 (96-98)





## FILTRI ARIA

### AIR FILTERS

ART. **11765**      FILTRO ARIA      (Sim. 487719)



#### DERBI

ATLANTIS 2T 50 ('10) - ATLANTIS 2T EU2 ('07-'09) - BULLET 50 ('02)  
BOULEVARD 2T 50 ('09) - GP1 50 ('01-'03) - GP1 OPEN EU2 50 ('06-'09)

#### GILERA

DNA 50 ('00-'07) - GP EXPERIENCE 50('03-'04) - ICE 50 ('01-'05)  
RUNNER POGGIALI 50 ('02) - SP 50 ('02-'06) - SP SR.SPEC.50 ('07) - ST 50 ('08)  
STALKER 50('97-'09)-NAKED 50('08)-STALKER SR. SPEC.50 ('07-'08)  
STORM EURO2 50 ('07) - TYPHOON 50('01-'11) - 2T EU2 50 (10-16) - 2T EU3 CH 50 (2011) - 2T EU4 50 (2018)

#### PIAGGIO

DIESIS 50 ('01) - FLY 2T 50 ('05-'07) - LIBERTY 2T 50 ('06-'08) - 2T RST 50 ('04) - 2T SPORT 50(06-08)- PTT EU2 50 ('04-'05)  
NRG MC3 50 ('01-'04) - NRG POWER DD 50('05-'08) - POWER DD - SR.SPECIALE 50 ('07-'08)-NRG DT 50 ('07-'08) - DT SR. SPEC.50 ('07-'08)  
VESPA LX 2T - 50 ('05-'13) - LX 2T TOURING & 30KM 50 (10-13) - LXV 2T 50 ('06-'09) - LXV 2T NAVY 50 ('08)  
VESPA PRIMAVERA 2T 50 (13-17) - VESPA S 2T & COLLEGE 50 (07-12) - VESPA SPRINT 2T NO ABS E2 50 (14-17)  
ZIP 50 ('00-'04) - ZIP SP 50('01-'04)-SP EU2 50('06-13 - ZIP 2T 50 (08-13)

ART. **11763**      FILTRO ARIA      (Sim. 487401)



#### DERBI

BOULEVARD EU3 125/150 ('03-'07) - BOULEVARD 4T 125-150 ('09)  
BOULEVARD 200 ('05)

#### PIAGGIO

SKIPPER 4T 125-150 ('00-'02)  
VESPA ET4 50 ('00-'05) - VESPA ET4 125-150 ('99-'02)

ART. **11776**      FILTRO ARIA      (Sim. 843194)



#### DERBY

BOULEVARD 4T EU2 50 ('09) - BOULEVARD 4T EU3 125 ('08-'09)

#### PIAGGIO

FLY 4T 50 ('05-'07) - 4T MOT.CHIN. 50 ('06-'07) - 4T 2V 50 ('13-'15) - 4T 4V 50 ('12-'13)  
FLY 4T 100 ('06-'14) - 125-150 ('05-'07) - EU3 125 ('07-'11) - EU3 150 ('08-'11)  
FLY 4T & 25-30 KM/H 50 (08-11) - 4T 2V 25-30KM-H 50 (12-17)  
LIBERTY 4T 2V EU3 125 (09-12) - MOC 4T EU3 150(09-13)  
VESPA LX 4T 50 ('05-'09) - LX 4T-4V 50(09-13)- LX 4T-4V TOURING 50(10-13)  
VESPA LX 4T EU3 TOURING 125(10-11) - LX TOURING 150(10-12) - LX 125-150(05-06)  
VESPA LX EU3 125-150 (06-08) - LX EU3 IE 125-150 (09-11) - LX 4T FL 125-150 (09)  
VESPA LXV 4T EU3 125 (06-09) - VESPA LXV IE 4T 125(10-13) - LXV 4T NAVY EU3 125(07-08)  
VESPA PRIMAVERA 4T 2V 25 KM/H 50(14-17) - PRIMAVERA 4T 3V 25 KM/H E4 50(17-19)  
VESPA PRIMAVERA 4T-3V NO ABS E4 50(17-18) - PRIMAVERA 4T-4V NO ABS 50(13-17)  
VESPA S 4T EU3 125(07-08) - S 4T 150(08-09) - S 4T-4V & COLLEGE 50 (08-12) - VESPA S 4T IE & COLLEGE 125-150 ('09-11)  
VESPA SPRINT 4T 2V 25 KM/H 50 (14-17) - SPRINT 4T 3V 25 KM/H E4 50 (17-19) - SPRINT 4T 4V NO ABS E2 EMEA 50 (14-17)  
VESPA SPRINT 4T-3V E4 50 (17-19) - X8 STREET EU2 125/150 ('06-'08)

#### GILERA

TYPHOON 4T 2V EU3 125 (10-11)

ART. **11708**      FILTRO ARIA      (Sim. 834741 ex 431838)



#### GILERA

EASY MOVING 50 ('95-'96)

#### PIAGGIO

ZIP 50 ('95-'96) - ZIP FAST RAIDER 50 ('93-'94)  
ZIP 4T 50 ('00-'08) - ZIP 4T 100 ('06-'08)





## FILTRI ARIA

### AIR FILTERS

ART. **11709**      FILTRO ARIA      (Sim. 433437)

#### GILERA

STORM 50 ('94-'95) - TYPHOON 50 ('94-'97)  
TYPHOON X 50 ('98-'99) - XR 50 ('00)

#### PIAGGIO

NRG 50 ('94-'96) - RST MC2 ('96-'98) - NTT ('95-'96)



ART. **11709-A**      FILTRO ARIA      (Sim. 479748)

#### GILERA

RUNNER 50 ('97-'00) - RUNNER PUREJET 50 ('02-'11)  
RUNNER PUREJET ST 50 ('08) - STALKER 50 ('97-'04)

#### PIAGGIO

NRG EXTREME 50 ('99-'00) - NRG RST MC2 50 ('96-'98)  
NRG MC3 50 ('01-'04) - PUREJET 50 ('02-'04) - 50 ('10)  
NRG POWER PUREJET 50 ('04-'11)



ART. **11766**      FILTRO ARIA      (Sim. 827936)

#### GILERA

DNA 125-180 ('01)  
RUNNER VX-VXR 125-180 ('00-'01)

#### PIAGGIO

X9 125 ('01-'02) - X9 AMALFI 180 ('00-'03)



ART. **11772**      FILTRO ARIA      (Sim. 831997)

#### GILERA

OREGON 250 ('06-'08)

#### PEUGEOT

SATELIS 250

#### PIAGGIO

MP3 125/250(06-08) - MP3 IE 125(08-09) - MP3 LT 250(08-09) - MP3 IE LT 300(10-11)  
MP3 MIC 250(08-09) - MP3 IE MIC 300(10-11) - MP3 IBRIDO 125(09-10)  
MP3 4T 4V IE ERL IBRIDO 300(10-13) - MP3 4T 4V IE LT IBRIDO 300(10-11)  
MP3 IE LT TOURING 300 (11-14) - MP3 IE TOURING 125/300(11-12)  
VESPA GRANTURISMO 125(03-07) - GRANTURISMO 200(06-07) - GRANTURISMO EU3 125(06-07)  
VESPA GT 60 EU3 250(06-07) - GTS EU3 125(07-12) - GTS 250(05-16) - GTS ABS 250(05-12)  
VESPA GTS IE TOURING 300(11-16) - GTS 4T IE SUPER 125(09-16) - GTS SUPER 300 (08-15) - GTS SUPER SPORT 300(10-13)  
VESPA GTV 125(06-08)-GTV 250 (06-09) - GTV 4T 4V IE 300-(10-13)-GTV 4T 4V IE 300(10-13)-GTV 4T NAVY EU3 125(08)  
VESPA GTV 4T NAVY EU3 250 ('07) - GTV MONTENAPOLIONE 300(10) - GTV SEI GIORNI IE E4 ABS (EMEA) 300 (2019)  
X EVO 125/250 ('07-'16) - X8 125 ('04-'06) - X8 200 ('05-'07) - X8 EU3 250 ('05-'08)  
X8 PREMIUM EU2 125 ('06) - X9 EVOLUTION 125 ('05-'06) - X9 EVOL.EU3 125 ('07)-X9 EVOL.250 ('06)



## FILTRI ARIA

### AIR FILTERS

ART. **11775**      FILTRO ARIA      (Sim. 487845-MAL.)06615400

**GILERA**

NEXUS 500 ('03-'05)  
NEXUS EU3 500 ('06-'08)  
NEXUS SP EURO3 500 ('06-'07)

**MALAGUTI**

SPIDERMAX GT EU3 500 - GT ('04-'05)

**PIAGGIO**

HEXAGON GTX 125-180 ('00)  
SUPER HEXAGON GTX 12" 125-180 ('01-'02)  
X9 500 ('01-'02)  
X9 EVOLUTION 500 ('03-'07)  
X9 ABS 500 ('06-'07)



ART. **11705**      FILTRO ARIA      (Sim. 257369)

**PIAGGIO**

SFERA 50 ('91-'93)  
SFERA MAQUILLAGE2 50 ('94)



ART. **11751**      FILTRO ARIA      (Sim. 482738)

**PIAGGIO**

LIBERTY 50 ('97-'05)



ART. **11764**      FILTRO ARIA      (Sim. 875525-487287)

**PIAGGIO**

LIBERTY 50 4T ('00-'02 / '05-'08)  
LIBERTY 125 ('01-'02) - LIBERTY 4T 125 ('06-'07) - LIBERTY 4T EU3 125 ('06-'08)  
LIBERTY 4T EU3 150 ('08) - LIBERTY 200 ('06) - LIBERTY 4T EU3 200 ('06-'08)  
LIBERTY RST 4T 50 ('04) - LIBERTY RST 125 ('04-'05) - LIBERTY RST 200 ('04)  
LIBERTY PTT 4T (DEU) 50 ('07-'12) - LIBERTY MOC 4T 50 ('09-'16)  
LIBERTY PTT 4T DOUBLE-NEXIVE 50 ('09-'15) - LIBERTY PTT RST 125 ('05-'11)  
LIBERTY PTT 4T 2V IE 125 ('12-'13) - LIBERTY DELIVERY SINGLE 4T 50 ('10-'14)  
LIBERTY DELIVERY SINGLE 4T EU3 125 ('07-'15)  
LIBERTY DELIVERY 4T TNT 50 ('09) - LIBERTY DELIVERY TNT 4T EU3 125 ('08-'15)  
LIBERTY SPORT 4T 50 ('07-'08) - LIBERTY SPORT 125 ('06)  
LIBERTY SPORT 4T EU3 125 ('06-'08) - LIBERTY SPORT 4T EU3 150 ('08)  
LIBERTY SPORT 200 ('06) - LIBERTY SPORT 4T EU3 200 ('06-'07)







## FILTRI ARIA

AIR FILTERS

ART. **11784** FILTRO ARIA (Sim. B018070)

### PIAGGIO

VESPA GTS SUPER IE 4T 3V 150 ('14-'15)  
VESPA LT 4T 3V IE 150 ('14) - VESPA LX 4T 3V IE TOURING 150 ('12-'13)  
VESPA LX PRIMAVERA 4T 3V IE 125 ('13-'17)  
VESPA PRIMAVERA 4T 3V 150 ('13-'16) - VESPA PRIMAVERA 4T 3V IGET ABS 125 ('16-'19)  
VESPA PRIMAVERA 4T 3V IGET ABS (EMEA) 150 (16-19)  
VESPA SPRINT 4T 3V IE 125 ('14-'15) - VESPA SPRINT 4T 3V IE 150 ('15)  
VESPA SPRINT IGET 4T 3V ABS 125 ('16-'19) - VESPA SPRINT SPORT 4T 3V IGET ABS 150 (16-19)



ART. **11720** FILTRO ARIA

### BENELLI

491 TUTTI MODELLI 50 CC. - K2 50-100 - NAKED 50 ('02)

### BETA

ARK ARIA/H20 50 ('96-'08) - ARK LC K 50 ('96-'03) - EIKON 50 ('99-'03)

### MALAGUTI

CENTRO 50-BASE-SL-F10 50-RST-EU2-EU3 50 - F12 ARIA - H20 50  
F12 RST EU2 - EU3 50 - F15 FIRE FOX EU2 ('02-'03) - YESTERDAY ('97-'00)

### MBK

EVOLIS 50 ('94-'95) - FIZZ 50 - FORTE 50 - NITRO 50 ('07-'02) - OVETTO 50('97-'00) - EU1 - EU2 50 ('02-'03)

### YAMAHA

AEROX 50 ('97-'02)-EU2 50('03)-AXIS 5 0('95-'96) - BREEZE 50 ('94-'95) - NEO'S 50 ('97-'02) - EU2 50 ('02)



ART. **11712-M** FILTRO ARIA (Sim.4HC144510000)

### BENELLI

VELVET 250 ('99-'01) - VELVET TOURING 250 ('02-'03)

### MBK

SKYLINER 250 ('00-'02) - ABS 250 ('03)

### YAMAHA

MAJESTY 250 ('96-'02) - DX ('98-'00)- ABS 250 ('03)



ART. **11710** FILTRO ARIA

### MBK

BOOSTER 50 ('90-'03) - ROAD 50 ('94-'95) - NG 50 ('95-'02) - TRACK 50 ('96-'98)  
ROCKET 50 ('97-'98) - SPIRIT 50 ('96-'00) - SPIRIT EURO2 50 ('02)-STUNT 50 ('00-'02)

### YAMAHA

BWS ORIGINAL 50 ('97-'02) - EURO2 50 ('02-'03) - BWS NEXT GENERATION 50 ('97-'02)



ART. **11715-B** FILTRO ARIA

### PEUGEOT

BUXI 50 ('94-'97) - ELYSEO 50 ('99)  
LOOXOR 50 ('01-'02) - METAL X 50('02)  
SQUAB 50 ('95-'97) - SPEEDAKE 50 ('95-'97)  
SPEEDFIGHT ARIA-H20 Kat ('97-'99)  
TREKKER 50 ('98-'00) - VIVACITY KAT-X FIGHT 50 ('00) - X RACE 50 ('03) - ZENITH 50



## FILTRI ARIA

### AIR FILTERS

ART. **11894** FILTRO ARIA APIRAZIONE (Sim.17210KGF900)

INTAKE AIR FILTER

#### HONDA

@ CHIOCCIOLA 125-150 ('00-'06)  
 DYLAN 125-150 ('01-'06)  
 PS 125-150i ('06-'08)  
 SH 125-150 ('01-'08) - SH 125i - SH 150i ('01-'08)



ART. **11895** FILTRO ARIA (Sim.17210KTW900)

#### HONDA

SH 300 i ('07-'08)



ART. **11892** FILTRO ARIA (KY.00162377-MAL.06611003)

#### KYMCO

AGILITY R16 125 ('09) - AGILITY R16 150 ('08-'09)  
 PEOPLE 125-150 ('99-'00) - PEOPLE EU2 125-150 ('03) - PEOPLE EU3 125 ('07-'08)  
 PEOPLE S 125-200 ('05) - PEOPLE S DD EU3 125 ('07-'08) PEOPLE S 200i ('07)  
 SUPER 8 125 ('09)

#### MALAGUTI

CIACK 125 150 ('00-'01) - CIACK RST EU2 125-150 ('03) - CIACK MASTER 125-150 ('04)  
 CIACK MASTER EU3 125 ('06) - CIACK MASTER EU2 200 ('06)



ART. **11880** FILTRO ARIA (Sim. 5DSE445100)

#### MBK

YP SKYLINER 125 ('98-'00)- 250 ('00)

#### YAMAHA

YP MAJESTY 125 ('98-'00) - 150 ('00)







## FILTRI ARIA

AIR FILTERS

ART. **11883**      FILTRO ARIA ASPIRAZIONE      (Sim.1B9144510000)

*INTAKE AIR FILTER*

**YAMAHA**

X CITY 125 ('08) - X CITY 250 ('07-'10)  
X MAX 125 ('06-'09) - X MAX 250 ('05-'10) - BLACK MAX 250 ('09)



ART. **11884**      FILTRO ARIA VARIATORE      (Sim.5GM154070000)

*VARIATOR AIR FILTER*

**YAMAHA**

X MAX 250 ('05-'10) - BLACK X MAX 250 ('09)  
MAJESTY 250 ('00-'03) - MAJESTY ABS 250 ('03)  
X CITY 250 ('07-'10) - VERSITY 300 ('03-'06)



ART. **11886**      FILTRO ARIA ASPIRAZIONE      (Sim.4B5144510000)

*INTAKE AIR FILTER*

**YAMAHA**

T MAX 500 ('08-'10) - T MAX ABS 500 ('08)  
WHITE MAX 500 ('10)



ART. **11887**      FILTRO ARIA      (Sim.4BH144510100)

**YAMAHA**

T MAX 500 ('01-'07) - T MAX ABS 500 ('05-'07)  
BLACK MAX 500 ('06) - NIGHT MAX 500 ('07)  
GTS 1100 ('93) - GTS A ABS 1100 ('93)



## FILTRI OLIO

### OIL FILTERS

ART. **11802**

FILTRO OLIO

(Sim.82635R-483727 - ITALJET 210483727 )

#### APRILIA

ATLANTIC 125 (03-05)-ATLANTIC 125-250 Eu3 (10)-ATLANTIC 300 (10-11)-MOJITO 125 (03-08)  
 SCARABEO 125 (03-06)- MOT.PIAGGIO EU3 125(06)-LIGHT 250 (06-08)-LIGHT 300(09-10)  
 SCARABEO SPORT CITY 125 (04-06)-SPORT CITY EU3 125 (06-08)-S.C. CUBE 125 (08-10)  
 SCARABEO SPORT CITY CUBE 250 (08-12)-SPORT CITY ONE 4T EU3 125 (08-11)  
 SPORT CITY STREET 125/300 (12)-SR MAX 125/300 (11-14)-SR MOTARD 125 (12-14)

#### BENELLI

ADIVA 125/150 (00-03)

#### GILERA

DNA 125-180 (01) -NEXUS EU3 125(07-08)-EU3 250 (06)-EU3 300 (08)-SP EU3 250 (06-07)  
 OREGON 250 (06-08)-RUNNER VX 125 (06)-VX 4T EURO3 125 (07)-VX 4T ST EU3 125 (08)  
 RUNNER VX RACE 125 (06)-VX SC 125 (06-07)-VX SC 125 (06-07)-VX-VXR 125-180 (00-01)  
 RUNNER VX-VXR 200 (02-04)-VXR 200 (05-06)-VXR 4T ST EU3 200 (08)-VXR EU3 200 (07)  
 RUNNER VXR RACE 200 (06)

#### ITALJET

TORPEDO 150 (00)

#### MALAGUTI

MADISON 3 125/250 (06-09)- R 180 (01-02)- S RST 200 (02)-S RST EU2 200 (02-03)  
 PHANTOM MAX 200 (03) - PHANTOM MAX 250 (04)

#### PIAGGIO

BEVERLY 125-200 (01-03) - 250 (06-07)-CRUISER 250(07-08)-EU3 125(07)-EU3 MIC 125-250 (07)  
 BEVERLY EU3 SPORT 125 (07)-IE EU3 250 (06-07) - RST 125 (06-07)-RST 250 (04-05)  
 BEVERLY SPORT 250 (06-07)-TOURER EU3 125-250 (08) - CARNABY 125-200 (07-08)  
 CARNABY 250 (08) - FLY 125-150 (05-07) - FLY EU3 125(07-08) - FLY EU3 150 (08)  
 HEXAGON GTX 125-180 (00) - LIBERTY 125-150 (01-02) - 4T 125 (06-07)-4T EU3 125-200 (07-08)  
 LIBERTY EU3 150 (08)-4T EU3 DELIVERY 125 (08)-4T SPORT EU3 125(06-08)-150 (08)-200 (06-07)  
 LIBERTY RST 125 (04-05)- RST 200 (04)-RST PTT 125 (05-06)-SPORT 125-200(06)  
 MEDLEY 4T IE ABS 125/150 (16)-MP3 125(07-08)-250(06-08)-MP3 YOURBAN (11-13)  
 SKIPPER 4T 125-150(00-02)-SUPER HEXAGON GTX 12" 125-180(01-02)  
 VESPA ET4 125-150 (99-02)-GRANTURISMO 125(03-07)-200(06-07)-EU3 125(06-07)-GT 60 EU3 250(06-07)-GTS EU3 125 (07-08)-GTS SUPER 300(08)  
 VESPA GTS, GTS ABS 250(05-08)-GTV 125(07-08)-250(06-07)-4T NAVY EU3 125-250(08)-LX 125-150 (05-06)-LX EU3 125-150 (06-08)  
 VESPA LXV 4T EU3 125 (06-08)-4T NAVY EU3 125 (08)-VESPA S 4T EU3 125 (07-08)-PRIMAVERA 4T 3V 12/150 (16)-SPRINT 4T 3V IE 125/150 (14-15)  
 X EVO 125-250 (07)-X7 EU3 125-250(08)-X8 125 (04-06)-200 (05-07)- X8 EU3 250(05-08)-X8 PREMIUM EU2 125(06-07)-X8 STREET EU2 125 (06)  
 X8 150 (06-08) - X9 125 (01-02)-X9 200 (02-03)-X9 AMALFI 180 (00-03)-X9 EVOLUTION 125 (03-06)-X9 EVOLUTION 200 (03)-250 (04-06)  
 X9 EVOLUTION EU3 125 (07) - X10 4T 4V IE EU3 125/350 (12-13) - ZIP 125 (00) - APE CALESSINO (CITY) 200 (13-16)



HF183



Ø mm. 50 x h67  
Filetto M14

ART. **11803**

FILTRO OLIO

(Sim.92960R ex 82658R-830239)

#### APRILIA

ATLANTIC 500 (01-04) - SCARABEO 500 (01-05) - SCARABEO LIGHT 400/500 (06-08)

#### GILERA

FUOCO EU3 500 (07-08) - FUOCO 4T-4V IE E3 LT 500 (07-13) - GP 800 (07-11)  
 GP CENTENARIO 800 (09) - NEXUS 500 (03-05) - NEXUS EU3 500 (06-11)  
 NEXUS SP EU3 500 (06-07)

#### MALAGUTI

SPIDERMAX GT 500 (04-07)

#### PIAGGIO

BEVERLY / EU3 400 (06-07) - BEVERLY 500 (02-06) - BEVERLY EU3 500 (06) CRUISER 500  
 (07-11) - MP3 400 (07-08) - X EVO 400 (07-11) - X8 EU3 400 (06-08)  
 X9 500 (01-02) - X9 EVOLUTION 500 (03-07) - X9 EVOLUTION ABS 500 (06-07)



HF184

Ø mm. 80 x h58  
Filetto M20

ART. **11800**

FILTRO OLIO

(Sim.410229 - ITALJET 210410229)

#### APRILIA

HABANA CUSTOM 125 (99-02)  
 SCARABEO 125-150-200

#### ITALJET

TORPEDO 125 (98-00)

#### PIAGGIO

HEXAGON LX4 125 (98-99)  
 LIBERTY 125 (98-00) - SFERA 125 (95-97)  
 VESPA ET4 125 (96-99)



HF181

Ø mm. 33 x h35





## FILTRI OLIO OIL FILTERS

ART. **11810**      FILTRO OLIO (Sim. 256450-256451 - PEUGEOT 737492)

**APRILIA**

LEONARDO 125-150 ('96-'04) - SCARABEO MOTORI ROTAX 125-150-200 ('99-'03)

**BMW**

C1 125 ('99-'03) - C1 200 ('00-'03)

**PEUGEOT**

ELYSEO 125-150 ('99-'01) - ELYSTAR 125-150 ('03-'04) - JET FORCE 125 ('03-'04)



HF185



Ø mm. 41 x h33

ART. **11804**      FILTRO OLIO (Sim.15410MJFD01)

**HONDA**

SH 300  
SILVERWING 400/600



HF951



Ø mm. 65 x h65  
Filetto M20

ART. **11807**      FILTRO OLIO (Sim. 00115058-1541ALEA700)

**KIMCO**

DOWNTOWN 125 ('09) - DOWNTOWN 200 ('10)  
DOWNTOWN 300 ('09) - DOWNTOWN 300i ('11)  
DOWNTOWN ABS ('10)  
PEOPLE GTI 125-200 ('10) - PEOPLE GTI 300 (10-'11)



HF566



Ø mm. 44 x h42

ART. **11805**      FILTRO OLIO (Sim. SF5131524)

**LML**

STAR 4T 125/150 ('09-'11)

**DAELIM**

VC 125 ('96-'05)  
VS/VT EVOLUTION 125 ('97-'05)



HF167



Ø mm. 38 x h36

## FILTRI OLIO

### OIL FILTERS

#### ART. 11816 FILTRO OLIO

**KYMCO**  
XCITING I 500 ('04)

**YAMAHA**  
T-MAX 500 ('01-'11)  
FZS FAZER 600 ('98-'03)  
QUAD YFM R RAPTOR 660 ('01-'05)



HF147  
Ø mm. 68 x h50  
Filetto M20

#### ART. 11823 FILTRO OLIO

**SUZUKI**

CC.	MODELLO
400	ARCTIC CAT QUAD
500	ARCTIC CAT QUAD
600	GSF BANDIT ('95-'02)
600	GSX F ('01-'05)
600	GSX R ('92-'05)
600	RF R - VS INTRUDER
650	BURGMAN ('03)
650	STROM DL V ('04-'05)
650	SV - S ('99-'05)
750	GSX ('98-'02)
750	GSX F ('89-'02)
750	GSX R ('88-'03)
800	VL INTRUDER ('01)
800	VX ('90-'97)
800	VS INTRUDER ('92-'95)
800	VZ MARAUDER ('97-'01)
900	RF R ('95)
1000	GSX R ('01-'04) - TL S - TL R ('97-'01)
1000	STROM ('02-'05)
1100	GSX F ('90) - GSX R ('86-'97)
1200	GSF BANDIT ('96-'05)-GSX ('98-'01)
1300	GSX R HAYABUSA ('99-'05)
1400	VS INTRUDER GL ('87-'98)
1500	VL INTRUDER ('98-'00)



HF138  
Ø mm. 68 x h 66  
Filetto M20 passo fine

#### ART. 11837 FILTRO OLIO (Sim.Honda 17230KEA00-Kawasaki 160970004)

**HONDA**

CC.	MODELLO
500	CB S - T
550	CBX - F - F2
600	CBR F ('87-'00)
600	HORNET ('98-'02)
600	XL - V - TRANSALP
600	VT SHADOW C
650	NRV REVERE
650	XR V AFRICA TWIN
750	WFR F ('90-'96)
750	VT C2
750	XR V AFRICA TWIN
800	PC
800	WFR F
900	CBR RR FIREBLADE
1000	CBR F ('89)
1000	CBR FL ('90-'95)
1000	VTR F FIRESTORM
1100	CBR XX BLACKBIRDE
1100	ST - VT C
1500	GLX

**KAWASAKI**

CC.	MODELLO
750	ZXR ('89-'99)

**YAMAHA**

CC.	MODELLO
600	FZ6 ('04-'06)
600	YZF THUNDERCAT ('95-'00)
600	R6 ('98-'05)
750	YXF - R7 ('99-'00)
1000	YZF - R1 ('98-'01)



HF303  
Ø mm. 65 x h73  
Filetto M20





## RUBINETTI BENZINA

FUEL COCKS



ART. **5344**

RUBINETTO BENZINA A DEPRESSIONE

**APRILIA**  
AMICO

**MBK**  
BOOSTER 50 - FIZZ 50 - FORTE 50

**ITALJET**  
VELOCIFERO - FORMULA

**YAMAHA**  
BREEZE 50 - BWS ORIGINAL

(Sim. 3VL-4500-0)



CODOLO  
Ø mm.6

CODOLO  
Ø mm.6

ART. **5344-NG**

RUBINETTO BENZINA A DEPRESSIONE

**MBK**  
BOOSTER NEXT GENERATION - SPIRIT

**YAMAHA**  
BWS NEXT GENERATION

(Sim. 4SBF-4500-00)



ATTACCO AL SERBATOIO DISASSATO  
RISPETTO AL CORPO RUBINETTO



CODOLO  
Ø mm.6

ART. **5345**

RUBINETTO BENZINA A DEPRESSIONE

**PIAGGIO**

FREE 50 ('92-'94) - FL 50 ('95-'02)-DELIVERY 50 ('00-'01)  
NRG 50 ('94-'96)-RST MC2 50 ('96-'98)- NRG EXTREME 50 ('99-'00)  
NRG MC3-RST 50 ('01-'04) - SFERA 50 ('91-'93) - RST 50 ('95-'97)  
SKIPPER LX 125-150 ('98-'99) - ZIP 50 - RST 50 ('94-'99) - SP 50 ('96-'00)  
ZIP FAST RIDER 50

(Sim. 295311)

**GILERA**

STALKER 50 ('97->) - STORM 50 - TYPHOON 50-125 - EASY MOVING 50

**MALAGUTI**

CROSSER 50 ('95-'98)- F12 PHANTOM

(Sim. 09304500)

**PEUGEOT**

SQUAB - ZENITH - BUXI

(Sim. 1173422700)

## RUBINETTI BENZINA

### FUEL COCKS

ATTACCO AL SERBATOIO DISSASSATO  
RISPETTO AL CORPO RUBINETTO



CODOLO  
Ø mm.6

ART. **5338**

RUBINETTO BENZINA A DEPRESSIONE

**MBK**  
OVETTO

**YAMAHA**

JOG R 50 ('06-'10) - NEO'S 50 ('04-'10) - NEO'S EU2 50 ('02-'03)  
R NEO'S 50 ('97-'02) - AEROX 50 ('97-'98)

(Sim. 5ADF4500000)

ART. **5339**

RUBINETTO BENZINA A DEPRESSIONE

**APRILIA**

RALLY 50 ('95) - SR 50 ('93-'97) SR ARIA e LIQUIDO

**MALAGUTI**

F10 - F12 - F15 - YESTERDAY 50

(Sim. 8201981)



CODOLO  
Ø mm.8

ART. **5334**

RUBINETTO BENZINA

**MODIFICA PER SOSTITUZIONE SISTEMA A DEPRESSIONE**  
*MODIFIED FOR REPLACE DEPRESSION SYSTEM*

SCOOTER PIAGGIO e VARI

ATTACCO AL SERBATOIO CENTRATO  
SUL CORPO RUBINETTO



CODOLO  
Ø mm.7

ART. **5346**

RUBINETTO BENZINA A DEPRESSIONE  
CON 2 MEMBRANE

(Sim.575321)

**PIAGGIO**

FLY 2T/4T 50 ('05-'07)-4T 50('08)- FLY 4T MOTORE CHIN 50 ('06-'07) - FLY 100 ('06-'08)  
FLY 125-150 ('05-'07) - EU3 125 ('07-'08)-EU3 150('08) -  
LIBERTY 2T/4T RST 50 ('04) - 2T/4T SPORT 50 ('06-'08) - 2T 50 ('06-'08) - 4T 50 ('00-'02)  
LIBERTY 4T 50 ('05-'08) - 4T DELIVERY TNT 50 ('09) - MOC 2T/4T 50 ('09) - 125/150 ('01-'02)  
LIBERTY RST 125 ('04-'05) - ST PTT 125 ('05-'06)-SPORT 125 ('06)-4T 125 ('06-'07) - 125 ('07-'08)  
LIBERTY 4T EU3 DELIVERY 125 ('08) - MOC 4T 125/150 ('09) - RST 200 ('04) - SPORT 200 ('06)  
LIBERTY 4T EU3 200 ('07-'08) - SKIPPER 4T 125/150 ('00-'02) - VESPA ET2 50 ('97-'05)  
VESPA ET4 50 ('00-'05) - ET4 125/150 ('99-'02) - GRANTURISMO 125/200 ('03-'07)  
VESPA GRANTURISMO EU3 125 ('06-'07) - GTV 125 ('07-'08)-LX 2T/4T 50 ('05-'08)-LX 2T FL 50 ('09)  
VESPA LX 4T/4V 50 ('09) - LX 125/150 ('05-'06) - LX EU3 125/150 ('06-'08) - LX 4T FL 125 ('09)  
VESPA LXV 2T 50 ('06-'08) - LX 2T NAVY 50 ('08)-4T EU3 125 ('06-'09) - VESPA S 2T 50 ('07-'08)  
VESPA S 4T-4V 50 ('08-'09) - ZIP 50 ('00-'04) - 2T 50 ('08-'09) - 4T 50 ('00-'08)  
ZIP SP 50 ('01-'04) - ZIP SP EU2 50 ('06-'09) - ZIP 100 ('06-'08) - 125 ('00-'02)

**GILERA**

DNA GP EXPERIENCE 50 ('03-'04) - DNA 50 ('05-'07)

**MALAGUTI**

CENTRO 4T 50 ('08)

(Sim.09310700)





## RUBINETTI BENZINA

FUEL COCKS



CODOLO  
Ø mm.7

ART. **5347**

RUBINETTO BENZINA A DEPRESSIONE  
CON 2 MEMBRANE

(Sim.577881)

**GILERA**

DNA 50 ('00-'02)  
RUNNER 50 ('97-'00) - POGGIALI 50 (02) - SP 50 ('02-'04)  
RUNNER FX/FXR 125/180 ('97-'02) - VX/VXR 125/200 ('02-'04)



CODOLI Ø mm.7

ART. **5337**

RUBINETTO BENZINA A DEPRESSIONE

**APRILIA**

SCARABEO 50/100

(Sim.860176)

**MALAGUTI**

MADISON 125 ('99-'01) - RST 125 ('02) - T 150 ('99-'01)

(Sim.09305900)

**MBK**

SKYLINER 125 ('98-'00) - SKYLINER 150 ('00)

(S.5DSF450000)

**YAMAHA**

MAJESTY 125 ('98-'00) - MAJESTY 150 ('00)

ATTACCO AL SERBATOIO DISASSATO  
RISPETTO AL CORPO RUBINETTO



CODOLO  
Ø mm.6

ART. **5336**

RUBINETTO BENZINA A DEPRESSIONE  
CON INDICATORE ELETTRICO LIVELLO CARBURANTE  
*FUEL COCK WITH ELECTRICAL FUEL LEVEL INDICATOR*

**PEUGEOT.**

VIVACITY 50 ('99) - VIVACITY CATALITICO 50 ('99-'02)

(Sim.741153)

## RUBINETTI BENZINA

### FUEL COCKS



ART. **11420**

POMPA A DEPRESSIONE

**PIAGGIO**

HEXAGON 125 e 150 ('94-'97)

(Sim.82592R - 431109)

**GILERA**

RUNNER 50 ('97-'00)-POGGIALI 50 ('02)-SP 50 ('02-'04)  
 RUNNER FX-FXR 125-180 ('97-'02)  
 TYPHOON 125 ('95-'98) - X-XR 125 ('99-'00)

**MALAGUTI** CIAK 50 - CIAK 50 TD ('99->)

(Sim.09305700)

ADATTABILE / SUITABLE: KART e MACCHINE CAMPI GOLF



ART. **11410-NY**

POMPA A DEPRESSIONE

(Sim.CM120901- 827894)

**PIAGGIO**

BEVERLY 125-200 ('01-'03) - 250 ('06-'07) - RST 125-('04-'07) - 250 ('04-'05)  
 FLY 4T 2V 25-30 KM-H 50 ('12-'14)-FLY 4T-2V 50 (13-15)-FLY 4T-4V 50 (12-13)  
 HEXAGON GTX 125-180 (00) - LX-LXT 125-180 (00) - LX4 125 (98-99)  
 MP3 125 (07-08)  
 NRG POWER DD 50 ('05-'08) - DT 50 ('06-'08) - PUREJET 50 ('04-'11)  
 VESPA GRANTURISMO 125-200 ('06-'07) - GRANTURISMO EU3 125 (06-07)  
 VESPA GTV 125 (07-08)-XEVO 125 (07-12)  
 X8 125 (05-06) - X8 200 (05-07) - X8 PREMIUM EU2 125(06)-EU3 125 (06-07)  
 X8 -STREET EU2 125-150 (06)  
 X9 125 ('01-'02) - 200 ('02-'03) - X9 AMALFI 180 ('00-'03)  
 X9 EVOLUTION 125 ('03-'06) - 200 ('03) - 250 ('04) - 250 ('06)

**GILERA**

DNA 50 (00-02/05-07) - GP EXPERIENCE 50 (03-04)  
 RUNNER PUREJET 50 (05-07)-ST 50 (08) - SP 50 (05-07)-EDIZIONE SPECIALE 50 ('07)  
 RUNNER SP ST 50 ('08)-VX 125 ('05-'06) - VX RACE 125 ('06) - VX SC 125 ('06-'07)  
 RUNNER X-VXR 125 - 200 ('02-'04) - VXR 200 ('05-'06) - VXR EU3 200 ('07)  
 RUNNER VXR RACE 200 ('06)

ART. **6246**

RACCORDO TUBO OLIO / OIL PIPE FITTING

(Sim.574362)



**PIAGGIO**

FLY 2T 50(05-07)-FREE 50(92-94)-FL 50(95-02)-DELIVERY 50(00-01)-HEXAGON LX4 125 (98-99)  
 LIBERTY 50 (97-05)-2T 50 (06-08)- RST 2T 50 (04)-2T SPORT 50 (06-08)-MOC 2T 50 (09)  
 LIBERTY PTT EU2 50 (04-05) - NRG 50 (94-96) - RST MC2 50 (96-98)-EXTREME 50 (99-00)  
 NRG MC3 50 (01-04)-POWER DD 50 (05-09)-DD SR. SPECIALE 50 (07-08)-POWER DT 50 (06-08)  
 NRG DT SR.SPECIALE 50 (07-08) - PUREJET 50 (02-04) - POWER PUREJET 50 (04-08)  
 NTT 50 (95-96)-QUARTZ 50 (92-96)-SFERA 50 (91-93)-RST 50 (95-97)-MAQUILLAGE 2 50 ('94)  
 SKIPPER 125/150(94-97) - SKIPPER LX 125/150(98-99)-SKR CITY 80(99)-VELOFAX 50(96-99)  
 VESPA ET2 50 (97-05)-ET2 INIEZIONE 50 (97-00) - VESPA LX 2T 50 (05-08)-LX 2T FL 50 (09)  
 VESPA LXV 2T 50 (06-08)-LXV 2T NAVY 50 (08) - VESPA S 2T 50 (07-08)  
 VESPA FL2 AUTOMATICA 50 ('90-'91)-PK S AUTOMATICA 50/125 ('84-'89)  
 VESPA COSA CL/CLX 125-150-200 ('88-'91) - COSA 2 125-150-200 ('91-'97)  
 ZIP 50 (92-04)-2T 50 (08-09)-RST 50 (96-99)-FAST RIDER 50(93-94)-RST 50 (96-97)  
 ZIP BIMODALE 50 (94-97) - SP 50 (96-04) - SP EU2 50 (06-09) - APE RST MIX 50 ('99-'05)

**GILERA**

DNA GP EXPERIENCE 50 ('03-'04)-DNA 50 ('00-'07)-EAGLET 50 ('96)-AUTOMATICO 50 ('96-'97)  
 EASY MOVING 50('95-'96)-ICE 50 ('01) - RUNNER 50 ('97-'00)-FX/FXR 125/180 ('97-'02)  
 RUNNER POGGIALI 50 ('02) - PUREJET 50 ('02-'07)-ST 50 ('08)-SP 50 ('02-'07)  
 RUNNER SP EDIZ.SPEC.50 ('07)-SP ST & SIMONCELLI 50 ('08-'09) - STALKER 50 ('97-'09)  
 STALKER EDIZ.SPEC. 50('07-'08)-NAKED 50('08)-STORM 50 ('94-'95)-EU2 50 ('07)  
 TYPHOON 50 ('94-'09) - X 50 ('98-'99) - XR 50 ('00) - 125 ('85-'98) - XR 125 ('99-'00)





## POMPE ELETTRICHE BENZINA

ELECTRIC FUEL PUMPS

ART. **11431**

POMPA ELETTRICA CARBURANTE



### PIAGGIO

BEVERLY 125 cc. RST 4T 4V i.e. ('10->) - BEVERLY 300 cc. RST 4T 4V i.e. ('10->)  
BEVERLY 350 SPORT TOURING ('11->) - BEVERLY CRUISER 250 ('07-'09)  
BEVERLY CARNABY CRUISER 300 ('07-'09) - SPORT 250 ('07->)  
VESPA GT60 250 (05->) - GTS 250 ABS(05->) - GTS 300(08->) - GTS 300 i.e. (12->)  
VESPA GTS SUPER SPORT 300 ('10->)  
VESPA GTV 250 ('09->) - GTV VIA MONTENAPOLEONE 300 ('10->)

ART. **11432**

POMPA ELETTRICA CARBURANTE



### YAMAHA

XP T-MAX 500 i.e. ('04-'11)  
XP T-MAX 530 i.e. ('12->)  
XP T-MAX 530 i.e. ABS ('12->)  
MAJESTY 400 ('04-'11)  
RX-MAX 125 ('08-'12)  
RX-MAX 250 ('07-'09)

## SERIE GUARNIZIONI MOTORE

### ENGINE GASKETS SET

#### PIAGGIO - GILERA



ART. **9385**

SERIE GUARNIZIONI COMPLETA  
COMPLETE GASKETS SET

#### PIAGGIO

DIESIS 50 - FREE 50-FL 50 - FREE DELIVERY 50  
NRG EXREME 50 - NRG MC3 50-POWER DT 50  
SFERA 50 - SFERA MAQUILLAGE 2 50 - SFERA RST 50  
SKR CITY 80  
VESPA ET2 50  
ZIP 50 RST-FAST RAIDER 50 - FAST RIDER RST 50

#### GILERA

EASY MOVING 50  
ICE 50  
STALKER 50 - STALKER NAKED 50 EDIZ.SPECIALE 50  
STORM 50  
TYPHOON 50 - X-XR 50

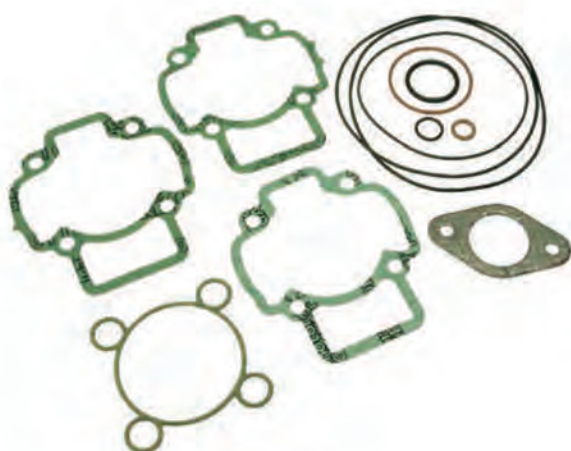

ART. **9385-H2O**

SERIE GUARNIZIONI COMPLETA  
COMPLETE GASKETS SET

MOTORI / ENGINE PIAGGIO - GILERA 50 cc. H2O

#### PIAGGIO

ZIP SP

#### GILERA

NRG EXTREME - NRG RST MC2





## SERIE GUARNIZIONI MOTORE ENGINE GASKETS SET

### APRILIA - MALAGUTI - MBK - YAMAHA



ART. **9310-TOP**

TOP SET GUARNIZIONI / TOP GASKETS SET

**APRILIA**

AMICO 50 ('90-'99)

**MBK**

BOOSTER 50 ('90-'95)-BW'S BUMP 50-BW'S NEXT GENERATION 50 ('97-'06)

**YAMAHA**

BW'S NEXT GENERATION KAT 50 ('99-'00)-BW'S ORIGINAL EURO2 50 ('03) - SPY 50 ('97-'03)

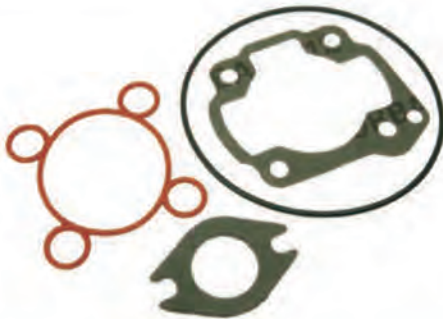

ART. **9355-TOP**

TOP SET GUARNIZIONI / TOP GASKETS SET

**APRILIA**

SR 50 H2o - RALLY 50 H2o

**MBK**

NITRO H2o

**MALAGUTI**

F12 PHANTOOM - F15 FIRE FOX H2o



ART. **9354-TOP**

TOP SET GUARNIZIONI / TOP GASKETS SET

**MALAGUTI**

F10 - CENTRO - YESTERDAY

### MOTORI ROTAX 125/150 cc. 4 TEMPI/STROKE



ART. **9300-TC**

GUARNIZIONE TESTA CILINDRO / CYLINDER HEAD GASKET

Ø mm. 58

MOTORI ROTAX 125 4T

## GUARNIZIONI

### GASKETS



ART. **9174**

BOCCOLA IN GRAFITE, INNESTO COLLETTORE SCARICO E MARMITTA  
GRAPHITE BUSH, JOINT MANIFOLD AND EXHAUST MUFFLER

(Sim. 8263885)

**Ø INTERNO/INTERNAL mm.32**  
**Ø ESTERNO/EXTERNAL mm.38,5**  
**ALTEZZA /HEIGHT mm.30**

#### SCOOTER APRILIA - GILERA - PIAGGIO

##### APRILIA

ATLANTIC 125-300  
SCARABEO LIGHT 250-300 - SPORT CITY CUBE 125-250 - SPORT CITY STREET 125-300  
SR MAX 125-300

##### GILERA:

DNA 125 -150 - RUNNER VX-VXR 125-180-200 - NEXUS EU3 125-250-300

##### PIAGGIO:

BEVERLY 125-250-300 - CARNABY 200-250-300  
MP3 125-250-300  
SUPER HEXAGON GTX 125  
VESPA GRANTURISMO 125-200 - VESPA GTS 125-250-300 - VESPA GTV 125-250-300  
X EVO 125-250 - X7 125-250-300 - X8 125-200-250 - X9 125-200 X9 EVOLUTION 125-200-250-X10 4T 125



ART. **9175**

BOCCOLA IN GRAFITE, INNESTO COLLETTORE SCARICO E MARMITTA  
GRAPHITE BUSH, JOINT MANIFOLD AND EXHAUST MUFFLER

(Sim. 8749465)

**Ø INTERNO/INTERNAL mm. 38**  
**Ø ESTERNO/EXTERNAL mm. 44**  
**ALTEZZA /HEIGHT mm. 28**

#### SCOOTER APRILIA - GILERA - PIAGGIO 350/400/500 cc.

##### APRILIA

ATLANTIC SPRINT 400/500 (05-08)  
SCARABEO LIGHT 400/500 (06-08)  
MANA 850 (07-11)-MANA GT 850 (09-16)  
SRV - SRV ABS ATC 850 (12-14)

##### GILERA

FUOCO EU3 500 (07-13) - FUOCO 4T-4V IE E3 LT 500 (13-14)  
GP 800 (07-08) - GP 800 (09-11) - GP CENTENARIO 800 (2009)  
NEXUS 500 (03-05) - NEXUS EU3 500 (06-08) - NEXUS EU3 500 (09-11) - NEXUS SP EU3 500 (06-07)

##### PIAGGIO

BEVERLY 500 (02-06) - BEVERLY EU3 400 (06-07) - BEVERLY EU3 500 (06-08)  
BEVERLY TOURER EU3 400 (08-10) - BEVERLY 4T 4V IE EU3 SPORT TOURING 350 (11-14)  
BEVERLY 4T ST IE ABS 350 (16-19) - BEVERLY CRUISER 500 (07-12)  
MP3 400 (07-08) - MP3 MIC 400 (08-10)  
MP3 IE LT - MP3 IE LT SPORT 400 (08-10) - MP3 IE LT TOURING 400 (2011)  
MP3 LT SPORT-BUSINESS 500(11-13) - MP3 LT BUSINESS ABS 500 (14-16)  
MP3 LT E4 SPORT-BUSINESS 500 (16-18)  
MP3 MAXI SPORT-BUSINESS E4 ABS 500(2018) - MP3 MAXI SPORT E4 ABS 350(18-19)  
MP3 RL SPORT - BUSINESS 500 (11-12) - MP3 RL TOURING 400 (2011)  
MP3 SPORT ABS 500 (14-16)  
X EVO 400 (07-11) - X8 EU3 400 (06-08)  
X9 500 (01-02) - X9 EVOLUTION 500 (03-07) - X9 EVOLUTION ABS 500 (06-07)  
X10 4T 4V IE EU3 350 (12-15) - X10 4T 4V IE EU3 500 (12-14)





## GUARNIZIONI

### GASKETS



ART. **9169**

GUARNIZIONE SCARICO PER MARMITTE  
EXHAUST GASKET

SCOOTER 50 cc.



ART. **9169-M**

GUARNIZIONE SCARICO PER MARMITTE  
**MODIFICATA PER RAPIDO MONTAGGIO**  
EXHAUST GASKET, MODIFIED FOR EASY ASSEMBLE

SCOOTER 50 cc.



ART. **9167**

GUARNIZIONE SCARICO UNIVERSALE  
EXHAUST GASKET

(Sim.432127)

SCOOTER 125 cc.

**PIAGGIO**

HEXAGON 125-150 ('94-'97) - HEXAGON LX-LXT 125-180 ('98-'99)  
SKIPPER 125-150 ('94-'97) - SKIPPER LX 125-150 ('98-'99)

**GILERA**

RUNNER FX-FXR 125-180 ('97-'02)  
TYPHOON 125 ('95-'98)- TYPHOON X-XR 125 ('99-'00)

Ø INTERNO / INTERNAL mm. 38



ART. **9170**

GUARNIZIONE SCARICO **SPIROMETALLICA** (25 x 34 x 3,5)  
EXHAUST METAL SPIRAL GASKET

motori / engine **YAMAHA**



ART. **9171**

GUARNIZIONE SCARICO **SPIROMETALLICA** (26 x 33 x 4,2)  
EXHAUST METAL SPIRAL GASKET

motori / engine **HONDA - PEUGEOT**



ART. **9173**

GUARNIZIONE SCARICO **SPIROMETALLICA** (25 x 37,5 x 4,2)  
EXHAUST METAL SPIRAL GASKET

motori / engine **YAMAHA** 125-150-180 4T

## CUFFIA CILINDRO

COOLING CYLINDER FAN



ART. **8170**

CUFFIA DI RAFFREDDAMENTO CILINDRO  
COOLING CYLINDER FAN

(Sim. 431536-433911)

**PIAGGIO**

FREE FL50 ('95-'02) - FREE DELIVERY 50 ('00-'01)  
SFERA 50 ('91-'93)  
ZIP 50 ('92-'93) - ZIP 50 ('95-'96) - ZIP RST 50 ('96-'99)  
ZIP BIMODALE 50 ('94-'97) - ZIP FAST RAIDER RST 50 ('96-'97)

**GILERA**

EASY MOVING 50 ('95-'96)  
STORM 50 ('94-'95)  
TYPHOON 50 ('94-'07)  
TYPHOON X 50 ('98-'99) - TYPHOON XR 50 ('00)



ART. **5041**

PRIGIONIERO FISSA CILINDRO mm. 6 x 105  
STUD SEC. CYLINDER

(Sim. 1A003633R-239382)

SCOOTER **PIAGGIO - GILERA 50 cc.**





## SETTORI AVVIAMENTO

### STARTER SECTORS



ART. **5013**

SETTORE AVVIAMENTO

(Sim.831458-488079-286210)

SCOOTER PIAGGIO-GILERA 50 cc.

#### PIAGGIO

DIESIS  
FLY  
FREE  
LIBERTY  
NRG  
SFERA  
VESPA E12  
VESPA E14  
VESPA LX  
VESPA LXV  
VESPA S  
ZIP

#### GILERA

DNA  
EASY MOVING  
ICE  
RUNNER  
STALKER  
STORM  
TYPHOON



ART. **5012**

SETTORE AVVIAMENTO

(Sim. 830284)

SCOOTER PIAGGIO MOTORI LEADER 4T

LIBERTY 125 ('01-'02)  
LIBERTY 4T EU3 125 ('06-'08)  
LIBERTY 4T EU3 DELIVERY (SINGLE) 125 ('07-'15)  
LIBERTY 4T EU3 DELIVERY (TNT) 125 ('08-'09)  
SKIPPER 4T 125 ('00-'02)  
VESPA ET4 125 ('99-'02)  
VESPA LX 125-150 ('05-'06)  
VESPA LX 4T FL 125 ('09)  
VESPA LX EU3 125-150 ('06-'08)  
VESPA LXV 4T EU3 125 ('06-'09) -  
VESPA LXV 4T NAVY EU3 125 ('07-'08)  
VESPA S 4T EU3 125 ('07-'08)  
ZIP 125 ('00-'02)

**PIAGGIO - GILERA**

**mazzucchelli**

AMT 218-A



ART. **10147-A**

ALBERO MOTORE **ARGENTATO**  
(spinnotto Ø mm.12)

**SILVER** CRANKSHAFT  
(pin Ø mm.12)

**PIAGGIO**

FREE - LIBERTY - NRG - NTT - QUARTZ - SFERA - ZIP  
VESPA ET2

**GILERA**

EASY MOVING - RUNNER - STALKER - STORM  
TYPHOON



**mazzucchelli**

AMT 218-M



ART. **10147-MM**

ALBERO MOTORE **ARGENTATO**  
*modello: CORSA ORIGINALE*  
**MASSE MAGGIORATE**  
(spinnotto Ø mm.12)

**SILVER** CRANKSHAFT "ORIGINAL STROKE"  
**OVERSIZE MASSE**  
(pin Ø mm.12)

**PIAGGIO**

FREE - LIBERTY - NRG - NTT - QUARTZ - SFERA - ZIP  
VESPA E12

**GILERA**

EASY MOVING - RUNNER - STALKER - STORM  
TYPHOON





## ALBERI MOTORE CRANKSHAFTS



**mazzucchelli**

**SCOOTER EQUIPAGGIATI CON MOTORI MINARELLI-YAMAHA 50 cc.**

**CILINDRO ORIZZONTALE / HORIZONTAL CYLINDER**

**mazzucchelli**

AMT 236-A



ART. **10144-A10**

ALBERO MOTORE ARGENTATO  
modello: **CORSA ORIGINALE** mm. 39,2  
(spinotto Ø mm.10 )

**SILVER CRANKSHAFT**  
**ORIGINAL STROKE** model mm. 39,2  
(pin Ø mm.10 )

**APRILIA**  
AMICO - SCARABEO - SR - RALLY - GULLIVER - SONYC

**BENELLI**  
491 4T - SPORT - K2 - BETA ARK - CHRONO - QUADRA - TEMPO

**ITALJET**  
DRAGSTER

**MBK**  
EVOLIS - FIZZ - NITRO - OVETTO - FLIPPER - HOT CHAMP

**MALAGUTI**  
F 10 - F 12 PHANTOOM - F 15 FIRE FOX - CENTRO - YESTERDAY

**YAMAHA**  
CY 50 - BREEZE - AEROX - AXIS - NEOS - JOG - WHY

## GABBIE SPINOTTO BIELLA ROLLER CAGES



CIF ART.	Rif.Orig.	DIMENSIONI / SIZE	APPLICAZIONI / APPLICATIONS
<b>5623</b>	112145	<b>12 - 17 - 13</b>	motori <b>PIAGGIO-GILERA</b> - motori <b>YAMAHA</b> motori <b>MINARELLI</b> con biella modificata a 12 mm. / with modified con-rod to 12 mm.
<b>5623-15</b>		<b>12 - 17 - 15</b>	motori <b>PIAGGIO SCOOTER</b> - <b>VESPA</b> e <b>APE</b> .....
<b>5625</b>	151805	<b>16 - 20 - 20</b>	<b>PIAGGIO</b> HEXAGON 125-150 (94-97)-HEXAGON LX-LXT 125-180(98-99)-SKIPPER 125-150 (94-97) <b>GILERA</b> RUNNER FX-FXR 125-180 (97-00)-TYPHOON 125 (95-98) - X-XR 125 ('99-'00)
<b>10137</b>		<b>10 - 14 - 13</b>	motori <b>YAMAHA</b> - <b>MINARELLI</b> orizzontali e verticali - <b>HONDA</b> - <b>PEUGEOT</b>
<b>10138</b>		<b>12 - 15 - 15</b>	<b>PEUGEOT</b> SV GEO - BUXI - SPEEDAKE - SQUAB - SPEEFIGHT - TREKKER - ZENIT
<b>10139</b>		<b>12 - 16 - 16</b>	motori <b>MORINI DITECH H2o</b> e <b>ARIA</b> anno 2000



ART. **5190-E1**

DADO FISSA GIRANTE FRIZIONE PULEGGIA CONDOTTA  
CHIAVE ESAGONO mm. 38 (M28 PASSO 1 mm.)

*NUT FIX CLUTCH DRIVEN PULLEY - HEXAGON KEY mm. 38 (M28 x 1 mm)*

SCOOTER:

**PIAGGIO - GILERA - APRILIA - DERBI - HONDA**  
**KYMCO - MALAGUTI - MBK - YAMAHA**



ART. **5191**

DADO FLANGIATO M10 - CHIAVE ESAGONO 15  
FISSA PULEGGIA MOTRICE E CONDOTTA

(Sim. 289519)

*FLANGED NUT M10 - HEXAGON KEY mm.15*  
*FOR FIX DRIVING AND DRIVEN PULLEY*

SCOOTER **PIAGGIO - GILERA**

PER ALBERO MOTORE LATO VOLANO E FRIZIONE:  
*FLYWHEEL AND CLUTCH SIDE FOR CRANKSHAFT*  
MOTORI/ENGINE **MINARELLI - YAMAHA**



ART. **3342**

ESTRATTORE VOLANO

*FLYWHEEL EXTRACTOR*

**PIAGGIO** SFERA - ZIP



**CUSCINETTI ALBERO MOTORE**

*CRANKSHAFT BEARINGS*

**motori ROTAX 125**

**APRILIA RS 125 STRADALE - APRILIA RX 125 ENDURO**



ART. **16060**

CUSCINETTO SKF 6206-C5 (30 x 62 x 16)  
*tolleranza / tolerance C5*



ART. **16061**

CUSCINETTO SKF 6206-**C104 H** (30 x 62 x16)  
*tolleranza speciale per alte temperature*  
*special tolerance for high temperatures*





## CUSCINETTI DI BANCO

### CRANKSHAFT BEARINGS



CIF ART.	Rif. Orig.		MARCA BRAND	MISURE SIZE	GABBIA CAGE	APPLICAZIONI APPLICATIONS
<b>16155</b>	96925R			17 - 42 - 13	FERRO STEEL	MOTORI PIAGGIO 50 cc. 4 TEMPI / STROKE DAL / SINCE 2000
<b>16204-C4</b>				20 - 47 - 14 (6204-C4)	FERRO STEEL	MOTORI SCOOTER 50 cc.
<b>16204-NBB</b>			NBB	20 - 47 - 14 (6204-C3)	FERRO STEEL	motori MINARELLI - YAMAHA motori MORINI DITECH H20 2000 motori DERBI
<b>16167-C4</b>				20 - 47 - 14 (6204-TN9 C4)	POLIAMMIDE POLYAMID	SCOOTER: APRILIA - MALAGUTI - MBK
<b>16169-SKF</b>	431125			20 - 52 - 12 (BB1 3055 C)	10 SFERE FERRO 10 BALLS STEEL	PIAGGIO SFERA - ZIP - ZIP FAST RIDER - FREE LIBERTY - NTT - NRG - DIESIS
<b>16169</b>	431125			20 - 52 - 12	10 SFERE FERRO 10 BALLS STEEL	GILERA TYPHOON - STALKER - RUNNER KYMCO HEROISM - SNIPER - SNIPER DD - PEOPLE PEUGEOT BUXI - GEO - SPEEDAKE - SQUAB ELISEO
<b>16169-8S</b>	431125			20 - 52 - 12 (BB1 447205A)	8 SFERE POLIAMMIDE 8 BALLS POLYAMID	PGO STAR
<b>16162</b>	494818			25 - 52 - 13 (BB1 3056 C)	POLIAMMIDE POLYAMID	ITALJET FORMULA 50 MALAGUTI CROSSER SUZUKI KATANA
<b>16170</b>				25 - 56 - 12	FERRO STEEL	PEUGEOT ELISEO 100 - SV 100 - VIVACITY 100 TREKKER 100 - SPEEDFIGHT 100 HONDA SH 50 e 100 dal '96 - SKY 100 - BALI 100 KYMCO SNIPER 50 - HEROISM 50 - PEOPLE 50 TOP BOY 50
<b>16305-C5</b>	169809			25 - 62 - 17 (C5)	FERRO STEEL	PEUGEOT ELISEO 125
<b>16171</b>	483970 431320			25 - 68 - 12	FERRO STEEL	PIAGGIO HEXAGON LX - LXT 125-180 - 125 LX4 LIBERTY 125 - SKIPPER 125-150 SKIPPER LX 125-150 SFERA 125 - VESPA ET4 125 GILERA RUNNER FX-FXR 125-180 TYPHOON 125 -X-XR 125



TABELLA IN ORDINE CRESCENTE IN BASE AL Ø INTERNO / LIST IN ORDER OF INTERNAL Ø

DIMENSIONI Ø INT. EST. h	Rif. Orig.	CIF ART.	APPLICAZIONI / APPLICATIONS	
8 16 10/11	435203.5	<b>5935</b>	per girante pompa acqua / for H2o pump rotor SCOOTER PIAGGIO-GILERA 50/125/150/180 cc.	<b>CORTECO</b> 
10 18 4	152351	<b>5932</b>	per girante pompa acqua / for H2o pump rotor SCOOTER motori MINARELLI-YAMAHA 50 cc. per coperchio frizione / for clutch cover : VESPA 50/125 FL-50 HP APE MP 501-P601-220 (1978-1976)	<b>CORTECO</b> 
15,6 25,5 7 RP		<b>5929</b>	lato frizione / clutch side : PEUGEOT 50 cc. BUXI-ELYSEO-SQUAB-SV GEO- TREKKER .... lato volano e frizione / flywheel and clutch side PEUGEOT FOX	<b>CORTECO</b> 
16 30 4,5	037616	<b>5931</b>	lato volano / flywheel side MOTORI PEUGEOT 100 cc. ELYSEO 100 - SV 100 - VIVACITY 100 TREKKER 100	<b>CORTECO</b> 
17 26 6 Vm		<b>5920-V</b>	in <b>VITON MARRONE / BROWN VITON</b> lato volano / flywheel side MOTORI MORINI DITECH H20 2000 APRILIA SR 2000-ITALJ.FORMULA-SUZUKI KATANA	<b>CORTECO</b> Viton 
17 28 5		<b>5924</b>	motori MINARELLI-YAMAHA SCOOTER APRILIA - MALAGUTI - MBK	<b>ROLF</b> 
17 28 7 RHTC-ACM	969028	<b>5940-AN</b>	lato volano / flywheel side motori PIAGGIO 50 cc. 4 TEMPI/STROKE versione anno 2000-2004 motori CHIN del 2006	<b>CORTECO</b> 
18 28 7 RP	286359	<b>5936</b>	doppio labbro / double lip lato volano / flywheel side SCOOTER PIAGGIO - GILERA	<b>ROLF</b> 
18 28 7/7,5 RP Vm	482315	<b>5936-V</b>	in <b>VITON MARRONE / BROWN VITON</b> doppio labbro / double lip lato volano / flywheel side SCOOTER PIAGGIO - GILERA	<b>CORTECO</b> Viton 
19 30 7 RP		<b>5937</b>	doppio labbro / double lip lato frizione / clutch side SCOOTER PIAGGIO - GILERA 50 cc. 2T	<b>ROLF</b> 
19 30 6,5 RP Vm	482314	<b>5937-V</b>	in <b>VITON MARRONE / BROWN VITON</b> doppio labbro / double lip lato frizione / clutch side SCOOTER PIAGGIO - GILERA 50 cc. 2T	<b>CORTECO</b> Viton 





## ANELLI DI TENUTA SCOOTER

### SCOOTER OIL SEALS



TABELLA IN ORDINE CRESCENTE IN BASE AL Ø INTERNO / LIST IN ORDER OF INTERNAL Ø

DIMENSIONI Ø INT. EST. h	Rif. Orig.	CIF ART.	APPLICAZIONI / APPLICATIONS	
20 30 5/6.1RP		5925	doppio labbro / double lip lato volano / flywheel side SCOOTER motori MINARELLI-YAMAHA APRILIA - MALAGUTI - MBK	CORTECO 
20 30 7 RP		5930	lato volano / flywheel side : PEUGEOT 50 cc. BUXI-ELYSEO-SQUAB-GEO-TREKKER-ZENITH lato volano-frizione/flywheel-clutch side: LUDIX 50 lato frizione / clutch side: PEUGEOT 100 cc. ELYSEO - SV - VIVACITY - TREKKER	CORTECO 
20 42/43 8/9 RP		5926	doppio labbro / double lip lato frizione / clutch side  SCOOTER motori MINARELLI-YAMAHA APRILIA - MALAGUTI - MBK	CORTECO 
22 32 6 RP		5923	doppio labbro / double lip asse ruota posteriore / rear wheel axle SCOOTER motori MINARELLI-YAMAHA APRILIA - MALAGUTI - MBK  lato frizione / clutch side mot.PIAGGIO 50/100/125 cc.4 TEMPI/STROKE HEXAGON LX4 - FLY - LIBERTY - SFERA VESPA ET4-VESPA LX 4T - ZIP 4T	CORTECO 
22 40 7 RSX Vm	239848	5939-V	in VITON MARRONE / BROWN VITON per alberino puleggia condotta for driven pulley shaft  SCOOTER PIAGGIO-GILERA	CORTECO 
24 35 7 Vm	434582	5941-AN	in VITON MARRONE / BROWN VITON lato frizione-volano / clutch-flywheel side motori PIAGGIO-GILERA 125/150/180 cc. 2T HEXAGON LX-LXT-SKIPPER-LX 125/150 TYPHOON X-XR -TYPHOON-RUNNER FX-FXR lato frizione / clutch side: MINARELLI 6 VEL./SPEED	CORTECO 
24 43 6		5922	lato frizione esterno / clutch external side motori MORINI DITECH H20 2000 VERSIONE CARBURATORE E INIEZIONE APRILIA SR 2000 - ITALJET FORMULA SUZUKI KATANA	CORTECO 
25 37 6 Vm		5921-V	in VITON MARRONE / BROWN VITON lato frizione interno / clutch internal side motori MORINI DITECH H20 2000 VERSIONE CARBURATORE E INIEZIONE APR.SR 2000-ITALJ.FORMULA-SUZUKI KATANA	CORTECO 
25,7 35 7/9	269888 123196	5968	forcella / fork PIAGGIO ZIP-ZIP & ZIP-ZIP FRENO A DISCO CICLOMOTORI SI - SI FL2	CORTECO 
26 42 7		5951	asse ruota posteriore / rear wheel axle PEUGEOT BUXI	CORTECO 
30 47 6	478498 8714	5950	asse ruota posteriore / rear wheel axle SCOOTER PIAGGIO - GILERA VESPA PE 200 ARCOBALENO	CORTECO 



CON PARAOLI / WITH OIL SEALS







## SERIE PARAOLI MOTORE

OIL SEALS SET

### TABELLA APPLICATIVA SERIE PARAOLI MOTORE OIL SEALS SET APPLICATIONS LIST



CIF ART. CODE CIF	TIPO SERIE SET TYPE	APPLICAZIONI APPLICATIONS	
6655-SR		SERIE RIDOTTA SMALL SET	MOTORI / ENGINE <b>PIAGGIO-GILERA 50 cc. 2 TEMPI / STROKE</b>
6655-V		SERIE COMPLETA IN VITON COMPLETE SET IN VITON	MOTORI / ENGINE <b>PIAGGIO-GILERA 50 cc. 2 TEMPI / STROKE</b>  PIAGGIO SFERA BASE - SFERA RST - MAQUILLAGE2 - ZIP BASE ZIP RST - FAST RAIDER - SP - NRG -RST MC2 - NTT - FREE QUARTZ - VESPA ET2 - SKR CITY  GILERA TYPHOON - X - EASY MOVING - STORM
6657-V		SERIE COMPLETA IN VITON COMPLETE SET IN VITON	MOTORI / ENGINE <b>PIAGGIO-GILERA 125 cc. 2 TEMPI / STROKE</b>  PIAGGIO HEXAGON 125-150 - LX-LXT 125-180 SKIPPER 125-150 - LX 125-150  GILERA RUNNER FX-FXR 125-180 TYPHOON 125 - X-XR 125
6654-SR		SERIE RIDOTTA SMALL SET	MOTORI / ENGINE <b>MINARELLI - YAMAHA</b>  APRILIA MALAGUTI MBK YAMAHA
6654		SERIE COMPLETA COMPLETE SET	MOTORI / ENGINE <b>MINARELLI - YAMAHA</b>  APRILIA MALAGUTI MBK YAMAHA





# KIT REVISIONE ALBERI MOTORE

## CRANKSHAFTS REVISION KIT

### TABELLA APPLICATIVA **KIT** REVISIONE ALBERI MOTORE

### CRANKSHAFTS REVISION **KIT** APPLICATIONS LIST



CIF ART. KIT KIT CODE CIF	MARCA CUSCINETTI BEARINGS BRAND	APPLICAZIONI APPLICATIONS
16180-KT		
16180-KTV		MOTORI / ENGINE <b>PIAGGIO-GILERA 50 cc. 2 TEMPI/STROKE</b>
16380-KT		PIAGGIO: FREE - LIBERTY - NRG - NTT - QUARTZ - SFERA - VESPA ET2 - ZIP - FAST RAIDER.. GILERA: DNA - RUNNER - STALKER - STORM - TYPHOON
16380-KTV		
16412-KT		MOTORI / ENGINE <b>PIAGGIO 50 cc. 4 TEMPI/STROKE VERSIONE 2002</b> PIAGGIO LIBERTY 50 4T .....
16416-KT		MOTORI / ENGINE <b>PIAGGIO 50 cc. 4 TEMPI/STROKE - MOTORI CHIN.</b> PIAGGIO FLY 50 4T - 100 4T - LIBERTY SPORT 50 4T - ZIP 50 4T
16182-KT		MOTORI / ENGINE <b>PIAGGIO -GILERA 125-150-180 cc. 2 TEMPI/STROKE</b> PIAGGIO HEXAGON 125-150 - LX-LXT 125-180 - SKIPPER 125-150 - LX 125-150 GILERA RUNNER FX-FXR 125-180 - TYPHOON 125 - X-XR 125
16186-KTC4		MOTORI / ENGINE <b>MINARELLI - YAMAHA</b>
16186-KTE		SCOOTER: APRILIA MALAGUTI MBK YAMAHA
16186-NBB	NBB	
16192-KT		MOTORI / ENGINE <b>MORINI DITECH H2O 2000 VERSIONE CARBURATORE E INIEZIONE</b> APRILIA SR 2000 - ITALJET FORMULA - SUZUKI KATANA
16187-KT		MOTORI / ENGINE <b>PEUGEOT 50 cc.</b>
16387-KT		BUXI - ELYSEO - LOOXOR - METAL X - SPEEDAKE - SPEED FIGHT - SQUAB SV GEO TREKKER - VIVACITY - X FIGHT - X RACE - ZENITH
16400-KT		MOTORI / ENGINE <b>PEUGEOT 50 cc.</b> LUDIX 50
16403-KT		MOTORI / ENGINE <b>PEUGEOT CILINDRO VERTICALE E POMPA OLIO ELETTRONICA WITH VERTICAL CYLINDER AND ELECTRONIC OIL PUMP</b>



## KIT REVISIONE ALBERI MOTORE

### CHRAKSHAFTS REVISION KIT

**PIAGGIO / GILERA 50 cc.**



ART. **16180-KT**

**KIT** REVISIONE ALBERO MOTORE

VERSIONE CON:

**CUSCINETTI NTN**  
+  
**PARAOLI ROLF**



CRANKSHAFT REVISION KIT  
VERSION WITH **NTN BEARINGS** + **ROLF OIL SEALS**

**PIAGGIO**

SFERA - QUARTZ - ZIP - ZIP FAST RIDER - FREE LIBERTY - NRG - NTT - VESPA ET2 ....

**GILERA**

TYPHOON - STORM - RUNNER - STALKER - DNA....

**KIT Composto da / Kit composed of:**

CIF ART.	Pz/Pcs	Misura / Size	Descrizione / Description
16169	2	20-52-12 (NTN)	Cuscinetti / bearings
5936	1	18-28-7 RP (Rolf)	Paraolio lato volano / oil seal, flywheel side
5937	1	19-30-7 RP (Rolf)	Paraolio lato frizione / oil seal, clutch side

Viton  
oil seals



ART. **16180-KTV**

**KIT** REVISIONE ALBERO MOTORE

VERSIONE CON:

**CUSCINETTI NTN**  
+  
**PARAOLI VITON MARRONE CORTECO**



CRANKSHAFT REVISION KIT  
VERSION WITH **NTN BEARINGS**+**CORTECO VITON OIL SEALS**

**PIAGGIO**

SFERA - QUARTZ - ZIP - ZIP FAST RIDER - FREE LIBERTY - NRG - NTT - VESPA ET2 ....

**GILERA**

TYPHOON - STORM - RUNNER - STALKER - DNA....

**KIT Composto da / Kit composed of:**

CIF ART.	Pz/Pcs	Misura / Size	Descrizione / Description
16169	2	20-52-12 (NTN)	Cuscinetti / bearings
5936-V	1	18-28-7/7,5 RP Vm (Corteco)	Paraolio in Viton lato volano / brown Viton oil seal, flywheel side
5937-V	1	19-30-6,5 RP Vm (Corteco)	Paraolio in Viton lato frizione / brown Viton oil seal, clutch side







# KIT REVISIONE ALBERI MOTORE

## CRANKSHAFTS REVISION KIT

PIAGGIO / GILERA 50 cc.



ART. **16380-KT**

**KIT** REVISIONE ALBERO MOTORE

VERSIONE CON:

**CUSCINETTI SKF**  
+  
**PARAOLI ROLF**



CRANKSHAFT REVISION KIT  
VERSION WITH **SKF BEARINGS** + **ROLF OIL SEALS**

**PIAGGIO**

SFERA - QUARTZ - ZIP - ZIP FAST RIDER - FREE LIBERTY - NRG - NTT - VESPA ET2 ....

**GILERA**

TYPHOON - STORM - RUNNER - STALKER - DNA....

**KIT Composto da / Kit composed of:**

CIF ART.	Pz/Pcs	Misura / Size	Descrizione / Description
16169-SKF	2	20-52-12 (SKF)	Cuscinetti / bearings
5936	1	18-28-7 RP (Rolf)	Paraolio lato volano / oil seal, flywheel side
5937	1	19-30-7 RP (Rolf)	Paraolio lato frizione / oil seal, clutch side

Viton  
oil seals



ART. **16380-KTV**

**KIT** REVISIONE ALBERO MOTORE

VERSIONE CON:

**CUSCINETTI SKF**  
+  
**PARAOLI VITON MARRONE CORTECO**



CRANKSHAFT REVISION KIT  
VERSION WITH **SKF BEARINGS**+**CORTECO VITON OIL SEALS**

**PIAGGIO**

SFERA - QUARTZ - ZIP - ZIP FAST RIDER - FREE LIBERTY - NRG - NTT - VESPA ET2 ....

**GILERA**

TYPHOON - STORM - RUNNER - STALKER - DNA....

**KIT Composto da / Kit composed of:**

CIF ART.	Pz/Pcs	Misura / Size	Descrizione / Description
16169-SKF	2	20-52-12 (SKF)	Cuscinetti / bearings
5936-V	1	18-28-7/7,5 RP Vm (Corteco)	Paraolio in Viton lato volano / brown Viton oil seal, flywheel side
5937-V	1	19-30-6,5 RP Vm (Corteco)	Paraolio in Viton lato frizione / brown Viton oil seal, clutch side



## KIT REVISIONE ALBERI MOTORE

### CRANKSHAFTS REVISION KIT

#### PIAGGIO 50 cc. 4 TEMPI / STROKE



ART. **16412-KT**

**KIT** REVISIONE ALBERO MOTORE

VERSIONE CON:

**CUSCINETTI NTN**

+

**PARAOLI CORTECO**



CRANKSHAFT REVISION KIT  
VERSION WITH **NTN BEARINGS** + **CORTECO OIL SEALS**

**VERSIONE 2002** PIAGGIO LIBERTY 50 4T .....

**KIT Composto da / Kit composed of:**

CIF ART.	Pz/Pcs	Misura / Size	Descrizione / Description
16155	1	17-42-13 (NTN)	Cuscinetto lato volano / bearing, flywheel side
16170	1	25-56-12 (NTN)	Cuscinetto lato frizione / bearing, clutch side
5940-AN	1	17-28-7 RHTC-ACM (Corteco)	Paraolio lato volano / oil seal, flywheel side
5923	1	22-32-6 RP (Corteco)	Paraolio doppio labbro lato frizione / oil seal, double lip, clutch side

#### PIAGGIO 50 cc. MOTORI CHIN 4 TEMPI / STROKE



ART. **16416-KT**

**KIT** REVISIONE ALBERO MOTORE

VERSIONE CON:

**CUSCINETTI NTN**

+

**PARAOLI CORTECO**



CRANKSHAFT REVISION KIT  
VERSION WITH **NTN BEARINGS**+**CORTECO OIL SEALS**

**PIAGGIO**  
FLY 4T 50 ('05-'07) - 4T MOTORE CHIN 50 ('06-'07) - 4T 100 ('06-'07)  
LIBERTY 4T SPORT 50 ('06) - ZIP 4T 50 ('06-'07)

**KIT Composto da / Kit composed of:**

CIF ART.	Pz/Pcs	Misura / Size	Descrizione / Description
16155	2	17-42-13 (NTN)	Cuscinetti lato volano e frizione / bearings, flywheel and clutch side
5940-AN	1	17-28-7 RHTC-ACM (Corteco)	Paraolio lato volano / oil seal, flywheel side
5923	1	22-32-6 RP (Corteco)	Paraolio doppio labbro lato frizione / oil seal, double lip, clutch side





## SERIE PARAOLI MOTORE

### ENGINE OIL SEALS SET

#### PIAGGIO / GILERA 50 cc. 2 TEMPI / STROKE

**PIAGGIO** SFERA RST ('95-'97)-SFERA BASE ('91-'93)-SFERA MAQUILLAGE 2 ('94)-ZIP BASE-RST ('96-'99)  
ZIP FAST RIDER ('93-'97)-ZIP SP-NRG-RST MC2('96-'98)-NTT- FREE ('92-'00)-QUARTZ  
SKR CITY ('99) - VESPA ET2 - VESPA LX 50 2T

**GILERA** TYPHOON - TYPHOON X - EASY MOVING - STORM



ART. **6655-SR**

SERIE PARAOLI RIDOTTA  
(con paraoli **CORTECO** + **ROLF**)

SMALL SET OIL SEALS  
(with **CORTECO** + **ROLF** oil seals)

motori / engine:  
PIAGGIO-GILERA 50 cc. 2 TEMPI / STROKE

#### Serie Composta da / Set composed of:

 	ART. 5936 (18 x 28 x 7RP)	(Sim.286359)
	lato volano flywheel side	
 	ART. 5937 (19 x 30 x 7)	(Sim.239391)
	lato frizione clutch side	
 	ART. 5950 (30 x 47 x 6)	(S.478498 ex 8714)
	ruota posteriore rear wheel	

#### HIGH QUALITY FOR GREEN FUEL



ART. **6655-V**

SERIE PARAOLI COMPLETA  
(con paraoli **CORTECO**)

COMPLETE SET OIL SEALS  
(with **CORTECO** oil seals)

motori / engine:  
PIAGGIO-GILERA 50 cc. 2 TEMPI / STROKE

#### Serie Composta da / Set composed of:

 	ART. 5936-V (18 x 28 x 7/7,5 RP-Vm)	(Sim.482315)
	Viton Marrone / Brown Viton lato volano flywheel side	
 	ART. 5937-V (19 x 30 x 6,5 RP-Vm)	(Sim.482314)
	Viton Marrone / Brown Viton lato frizione clutch side	
 	ART. 5950 (30 x 47 x 6)	(S.478498 ex 8714)
	ruota posteriore rear wheel	
 	ART. 5939-V (22 x 40 x 7 RSX-Vm)	(Sim.239848)
	Viton Marrone / Brown Viton alberino puleggia condotta driven pulley shaft	



## KIT REVISIONE ALBERI MOTORE

### CHANKSHAFTS REVISION KIT

#### PIAGGIO-GILERA 125/150/180 cc. 2 TEMPI / STROKE

- PIAGGIO** HEXAGON LX - LXT 125-180 ('98-'99) - HEXAGON 125-150 ('94-'97)  
 SKIPPER 125-150 ('94-'97) - SKIPPER LX 125-150(98-99)
- GILERA** TYPHOON X - XR 125 ('99-'00) - TYPHOON 125 ('95-'98) - RUNNER FX - FXR 125-180 ('97-'00)



ART. **16182-KT**

**KIT REVISIONE ALBERO MOTORE**

VERSIONE CON:

**CUSCINETTI NTN**

+

**PARAOLI VITON MARRONE**



CRANKSHAFT REVISION KIT  
 VERSION WITH **NTN BEARINGS**+**CORTECO VITON OIL SEALS**

motori / engine:  
**PIAGGIO - GILERA 125/150/180 cc. 2 TEMPI / STROKE**

#### KIT Composto da / Kit composed of:

CIF ART.	Pz/Pcs	Misura / Size	Descrizione / Description
16171	2	25-68-12 (NTN)	Cuscinetti lato volano e frizione / bearings, flywheel and clutch side
5941-AN	2	24-35-7 Vm (Corteco)	Paraoli in Viton Marrone lato volano e frizione / oil seal in Brown Viton, flywheel and clutch side

#### HIGH QUALITY FOR GREEN FUEL



ART. **6657-V**

SERIE PARAOLI COMPLETA  
 (con paraoli **CORTECO**)

COMPLETE SET OIL SEALS  
 (with **CORTECO** oil seals)

motori / engine:  
**PIAGGIO-GILERA 125/150/180 cc. 2 TEMPI / STROKE**

#### Serie Composta da / Set composed of:

	ART.5941-AN (24 x 35 x 7 Vm) (Sim.434582) Viton Marrone / Brown Viton lato volano flywheel side
	ART.5941-AN (24 x 35 x 7 Vm) (Sim.434582) Viton Marrone / Brown Viton lato frizione clutch side
	ART.5950 (30 x 47 x 6) (S.478498 ex 8714) ruota posteriore rear wheel
	ART.5906-V (22,7 x 47 x 7 Vm) (Sim.430391) alberino puleggia condotta driven pulley shaft





# KIT REVISIONE ALBERI MOTORE

## CRANKSHAFTS REVISION KIT

### MOTORI MINARELLI - YAMAHA

SCOOTER : APRILIA - MALAGUTI - MBK



ART. **16186-KTC4**

**KIT** REVISIONE ALBERO MOTORE

VERSIONE CON:

CUSCINETTI **SKF 6204 TN9 C4** GABBIA POLIAMMIDE  
POLYAMID CAGE



**TOLLERANZA/TOLLERANCE C4**

PARAOLI **CORTECO**

**KIT Composto da / Kit composed of:**

CIF ART.	Pz/Pcs	Misura / Size	Descrizione / Description
16167-C4	2	20-47-14 (SKF 6204-TN9 C4)	Cuscinetti / bearings
5925	1	20-30-5/6.1 RP (Corteco)	Paraolio lato volano / oil seal, flywheel side
5926	1	20-42/43-8/9 RP (Corteco)	Paraolio lato frizione / oil seal, clutch side



ART. **16186-KTE**

**KIT** REVISIONE ALBERO MOTORE

VERSIONE CON:

CUSCINETTI **SKF 6204 C4** GABBIA IN FERRO  
STEEL CAGE



**TOLLERANZA/TOLLERANCE C4**

PARAOLI **CORTECO**

**KIT Composto da / Kit composed of:**

CIF ART.	Pz/Pcs	Misura / Size	Descrizione / Description
16204-C4	2	20-47-14 (SKF 6204-C4)	Cuscinetti / bearings
5925	1	20-30-5/6.1 RP (Corteco)	Paraolio lato volano / oil seal, flywheel side
5926	1	20-42/43-8/9 RP (Corteco)	Paraolio lato frizione / oil seal, clutch side



ART. **16186-NBB**

**KIT** REVISIONE ALBERO MOTORE

VERSIONE CON:

CUSCINETTI **NBB 6204 C3** GABBIA IN FERRO  
STEEL CAGE



**TOLLERANZA/TOLLERANCE C3**

PARAOLI **CORTECO**

**KIT Composto da / Kit composed of:**

CIF ART.	Pz/Pcs	Misura / Size	Descrizione / Description
16204-NBB	2	20-47-14 (NBB 6204-C3)	Cuscinetti / bearings
5925	1	20-30-5/6.1 RP (Corteco)	Paraolio lato volano / oil seal, flywheel side
5926	1	20-42/43-8/9 RP (Corteco)	Paraolio lato frizione / oil seal, clutch side



## SERIE PARAOLI MOTORE

### OIL SEALS SET

#### MOTORI MINARELLI - YAMAHA

SCOOTER : APRILIA - MALAGUTI - MBK



ART. **6654-SR**

SERIE PARAOLI RIDOTTA  
(con paraoli **CORTECO**)

SMALL SET OIL SEALS  
(with **CORTECO** oil seals)

motori / engine: MINARELLI - YAMAHA  
(SCOOTER APRILIA - MALAGUTI - MBK)

#### Serie Composta da / Set composed of:

 	ART. 5925	(20 x 30 x 5/6.1 RP)  lato volano flywheel side
 	ART. 5926	(20 x 42/43 x 8/9 RP)  lato frizione clutch side



ART. **6654**

SERIE PARAOLI COMPLETA  
(con paraoli **CORTECO** + **ROLF**)

SET OIL SEALS  
(with **CORTECO** + **ROLF** oil seals)

motori / engine: MINARELLI - YAMAHA  
(SCOOTER APRILIA - MALAGUTI - MBK)

#### Serie Composta da / Set composed of:

 	ART. 5925	(20 x 30 x 5/6.1 RP)  lato volano flywheel side
 	ART. 5926	(20 x 42/43 x 8/9 RP)  lato frizione clutch side
 	ART.5923	(22 x 32 x 6 RP) DOPPIO LABBRO / DOUBLE LIP asse ruota posteriore rear wheel axle
 	ART.5924	(17 x 28 x 5)





## KIT REVISIONE ALBERI MOTORE

CRANKSHAFTS REVISION KIT

### MOTORI MORINI DITECH H2O



ART. **16192-KT**

**KIT** REVISIONE ALBERO MOTORE

VERSIONE CON:

**CUSCINETTI SKF**

+

**PARAOILI VITON MARRONE** 



CRANKSHAFT REVISION KIT  
VERSION WITH **SKF** BEARINGS + **CORTECO** VITON OIL SEALS

MOTORI MORINI DITECH H2O  
VERSIONE CARBURATORE E INIEZIONE

APRILIA SR 2000  
ITALJET FORMULA  
SUKUKI KATANA

#### KIT Composto da / Kit composed of:

CIF ART.	Pz/Pcs	Misura / Size	Descrizione / Description
16162	1	25-52-13 (SKF)	Cuscinetto gabbia poliammide <i>bearing, polyamid cage</i>
16167-C4	1	20-47-14 (SKF 6204-TN9 C4)	Cuscinetto gabbia poliammide <i>bearing, polyamid cage</i>
5920-V	1	17-26-6 Vm (Corteco)	Paraolio lato volano in <b>Viton Marrone</b> <i>oil seal in Brown Viton, flywheel side</i> 
5921-V	1	25-37-6 Vm (Corteco)	Paraolio lato frizione INTERNO in <b>Viton Marrone</b> <i>oil seal in Brown Viton, INTERNAL clutch side</i> 
5922	1	24-43-6 (Corteco)	Paraolio lato frizione ESTERNO <i>oil seal, EXTERNAL clutch side</i>

## KIT REVISIONE ALBERI MOTORE

### CRANKSHAFTS REVISION KIT

#### MOTORI PEUGEOT 50 cc.



ART. **16187-KT**

**KIT** REVISIONE ALBERO MOTORE

VERSIONE CON:

**CUSCINETTI NTN**

+

**PARAOLI CORTECO**



CRANKSHAFT REVISION KIT  
VERSION WITH **NTN BEARINGS** + **CORTECO OIL SEALS**

**PEUGEOT**

BUXI 50 (94-97) - ELYSEO 50 (99)  
LOOXOR 50 (01-03) - METAL X 50 (02) - SPEEDAKE 50 (95-97)  
SPEED FIGHT 50 (97-98) - SQUAB 50 (95-97) - SV GEO 50 (91-95)  
TREKKER 50 (98-00) - VIVACITY 50 (99) - X FIGHT 50  
X RACE 50 (03) - ZENITH 50 (94-98)

**KIT Composto da / Kit composed of:**

CIF ART.	Pz/Pcs	Misura / Size	Descrizione / Description
16169	2	20-52-12 (NTN)	Cuscinetti / bearings
5930	1	20-30-7 RP (Corteco)	Paraolio lato volano / oil seal, flywheel side
5929	1	15,6-25,5-7RP (Corteco)	Paraolio lato frizione / oil seal, clutch side



ART. **16387-KT**

**KIT** REVISIONE ALBERO MOTORE

VERSIONE CON:

**CUSCINETTI SKF**

+

**PARAOLI CORTECO**



CRANKSHAFT REVISION KIT  
VERSION WITH **SKF BEARINGS**+**CORTECO OIL SEALS**

**PEUGEOT**

BUXI 50 (94-97) - ELYSEO 50 (99)  
LOOXOR 50 (01-03) - METAL X 50 (02) - SPEEDAKE 50 (95-97)  
SPEED FIGHT 50 (97-98) - SQUAB 50 (95-97) - SV GEO 50 (91-95)  
TREKKER 50 (98-00) - VIVACITY 50 (99) - X FIGHT 50  
X RACE 50 (03) - ZENITH 50 (94-98)

**KIT Composto da / Kit composed of:**

CIF ART.	Pz/Pcs	Misura / Size	Descrizione / Description
16169-SKF	2	20-52-12 (SKF)	Cuscinetti / bearings
5930	1	20-30-7 RP (Corteco)	Paraolio lato volano / oil seal, flywheel side
5929	1	15,6-25,5-7RP (Corteco)	Paraolio lato frizione / oil seal, clutch side





## KIT REVISIONE ALBERI MOTORE

CRANKSHAFTS REVISION KIT

### MOTORI PEUGEOT 50 CC.



ART. **16400-KT**

**KIT** REVISIONE ALBERO MOTORE  
VERSIONE CON:

**CUSCINETTI SKF 6204 C4** GABBIA IN FERRO  
STEEL CAGE

**TOLLERANZA/TOLLERANCE C4**

**PARAOLI** **CORTECO**

CRANKSHAFT REVISION KIT  
VERSION WITH **SKF BEARINGS+CORTECO OIL SEALS**

PEUGEOT: LUDIX 50



**KIT Composto da / Kit composed of:**

CIF ART.	Pz/Pcs	Misura / Size	Descrizione / Description
16204-C4	2	20-47-14 (SKF 6204-C4)	Cuscinetti - gabbia in ferro / bearing - steel cage
5930	2	20-30-7 RP (Corteco)	Paraolio / oil seal

### MOTORI PEUGEOT 50 CC.

#### CILINDRO VERTICALE CON POMPA OLIO ELETTRONICA

WITH VERTICAL CYLINDER AND ELECTRONIC OIL PUMP



ART. **16403-KT**

**KIT** REVISIONE ALBERO MOTORE  
VERSIONE CON:

**CUSCINETTI SKF**

+  
**PARAOLI** **CORTECO**

CRANKSHAFT REVISION KIT  
VERSION WITH **SKF BEARINGS+CORTECO OIL SEALS**

motori PEUGEOT 50 CC.  
CILINDRO VERTICALE CON POMPA OLIO ELETTRONICA  
WITH VERTICAL CYLINDER AND ELECTRONIC OIL PUMP



**KIT Composto da / Kit composed of:**

CIF ART.	Pz/Pcs	Misura / Size	Descrizione / Description
16167-C4	1	20-47-14 (SKF 6204-TN9 C4)	Cuscinetto gabbia in poliammide / bearing, polyamid cage
16169-SKF	1	20-52-12 (SKF BB1 3055C)	Cuscinetto gabbia in ferro / bearings, steel cage
5930	1	20-30-7 RP (Corteco)	Paraolio lato volano / oil seal, flywheel side
5929	1	15,6-25,5-7RP (Corteco)	Paraolio lato frizione / oil seal, clutch side



## KIT REVISIONE POMPA ACQUA

### H<sub>2</sub>O PUMP REVISION KIT

#### PIAGGIO-GILERA 50 cc.

**PIAGGIO** NGR 50 ('94-'96) - EXTREME 50 ('99-'00) - RST MC2 50 ('96-'98) - MC3 50 ('01-'04) - PUREJET 50 ('02-'04)  
 NRG POWER DD 50 ('05-'08) - POWER DD SERIE SPECIALE 50 ('07-'08) - POWER PUREJET 50 ('04-'08)  
 NTT 50 ('95-'96) - QUARTZ 50 ('92-'96) - ZIP SP 50 ('96-'04) - ZIP SP EU2 50 ('06-'08)

**GILERA** DNA 50 ('00-'07) - DNA GP EXPERIENCE 50 ('03-'04) - RUNNER 50 ('97-'00) - POGGIALI 50 ('02)  
 RUNNER PUREJET 50 ('02-'07) - ST 50 ('08) - SP 50 ('05-'07) - SP SPECIALE EDIZ.50 ('07) - SP ST 50 ('08)



ART. **5403-K50**

KIT REVISIONE POMPA ACQUA  
 COMPLETO

COMPLETE SET  
 H<sub>2</sub>O REVISION KIT



**KIT Composto da / Kit composed of:**

CIF ART.	Pz/Pcs	Descrizione / Description
	1	Alberino / Shaft lunghezza / lenght mm. 64
8182	1	Girante pompa acqua / H <sub>2</sub> O pump rotor
16160-P	2	Cuscinetti schermati / screened bearings (8x22x7)
5935	1	Paraolio / oil seal (Corteco) (8x16x10/11)
7017	1	Anello OR 135 / O-ring
	2	Anello fermo / Seeger

#### PIAGGIO - GILERA 125/150/180 cc.

**PIAGGIO** HEXAGON 125-150 ('94-'97) - HEXAGON LX-LXT 125-180 ('98-'99)

**GILERA** RUNNER FX - FXR 125-180 ('97-'02)



ART. **5403-K125**

KIT REVISIONE POMPA ACQUA  
 COMPLETO

COMPLETE SET  
 H<sub>2</sub>O REVISION KIT



**KIT Composto da / Kit composed of:**

CIF ART.	Pz/Pcs	Descrizione / Description
	1	Alberino / Shaft lunghezza / lenght mm. 69
8183	1	Girante pompa acqua / H <sub>2</sub> O pump rotor
16160-P	2	Cuscinetti schermati / screened bearings (8x22x7)
5935	1	Paraolio / oil seal (Corteco) (8x16x10/11)
	2	Anello fermo / Seeger





## RICAMBI PER POMPA ACQUA

H<sub>2</sub>O PUMP SPARE PARTS



ART. **8182**

GIRANTE POMPAACQUA (Sim. 487730)  
H<sub>2</sub>O PUMP ROTOR

**PIAGGIO** NGR 50 ('94-'96)-EXTREME 50 ('99-'00)-RST MC2 50 ('96-'98)  
NRG MC3 50 ('01-'04)-PUREJET 50 ('02-'04)-NRG POWER DD 50 ('05-'08)  
NRG POWER DD SERIE SPEC.50 ('07-'08)-POWER PUREJET 50 ('04-'08)  
NTT 50 ('95-'96)-QUARTZ 50 ('92-'96)-ZIP SP 50('96-'04)- SP EU2 50 ('06-'08)  
**GILERA** DNA 50('00-'07)-GP EXPERIENCE 50('03-'04)-RUNNER 50('97-'00)  
RUNNER POGGIALI 50 ('02)-PUREJET 50 ('02-'07)-ST 50 ('08)  
RUNNER SP 50 ('05-'07)-SP SPECIALE EDIZIONE 50 ('07)-SP ST 50 ('08)



ART. **8183**

GIRANTE POMPA ACQUA (Sim. 487167)  
H<sub>2</sub>O PUMP ROTOR

**PIAGGIO** HEXAGON 125-150 ('94-'97) HEXAGON LX-LXT 125-180 ('98-'99)  
**GILERA** RUNNER FX - FXR 125-180 ('97-'02)



ART. **16160-P**

CUSCINETTO (8x22x7) - 2 lati schermati  
PER GIRANTE POMPAACQUA

BEARING - 2 screened sides  
FOR H<sub>2</sub>O PUMP ROTOR

SCOOTER **PIAGGIO - GILERA 50/125/150/180 cc.**  
SCOOTER MOTORI **MINARELLI - YAMAHA 50 cc.**

**CORTECO**



ART. **5935**

PARAOILIO (8x16x10/11) (Sim. 4352035)  
per GIRANTE POMPA ACQUA  
H<sub>2</sub>O PUMP ROTOR OIL SEAL

SCOOTER **PIAGGIO-GILERA 50/125/150/180 cc.**

**CORTECO**



ART. **5932**

PARAOILIO (10x18x4) (Sim. 152361)  
per GIRANTE POMPA ACQUA  
OIL SEAL FOR H<sub>2</sub>O PUMP ROTOR

SCOOTER MOTORI **MINARELLI-YAMAHA 50 cc.**

PER COPERCHIO FRIZIONE / FOR CLUTCH COVER :  
VESPA 50/125 FL - 50 HP  
APE MP 501-P601 220('78-'76)



ART. **7017**

ANELLO OR 135 (Sim.289254)  
per GIRANTE POMPA ACQUA  
H<sub>2</sub>O PUMP ROTOR O-RING

SCOOTER **PIAGGIO-GILERA 50/125/150/180 cc.**



ART. **7019**

ANELLO (53,67x1,78)  
PER GIRANTE POMPA ACQUA  
OIL SEAL FOR H<sub>2</sub>O PUMP ROTOR

SCOOTER MOTORI **MINARELLI-YAMAHA 50 cc.**

### motori MINARELLI - YAMAHA 50 cc.



ART. **5404-KTE**

KIT REVISIONE POMPAACQUA COMPLETO  
COMPLETE SET H<sub>2</sub>O REVISION KIT

KIT Composto da / Kit composed of:

CIF ART.	Pz/Pcs	Descrizione / Description
16160-P	2	Cuscinetti schermati / screened bearings (8x22x7)
5932	1	Paraolio / oil seal (Corteco) (10x18x4)
	1	Girante acqua / H <sub>2</sub> O pump rotor
7019	1	Anello OR (53,67x1,78)
18004	1	Girante traino pompa acqua H <sub>2</sub> O pump fun+pin+seeger



ART. **18004**

GIRANTE TRAINO POMPA ACQUA  
H<sub>2</sub>O PUMP FUN + PIN + SEEGER  
**APRILIA - MALAGUTI - MBK**

## KIT REVISIONE POMPA ACQUA

### H<sub>2</sub>O PUMP REVISION KIT



#### ART. **18016**

Ø stelo girante / rotor rod mm. 8

MOTORI PIAGGIO 4T 125-180-200 cc.

#### PIAGGIO

BEVERLY ('01-'03) - VESPA GT ('03-'05)  
X8 ('04) - X9 ('01-'03) - X9 EVOLUTION ('03)

#### GILERA

RUNNER VX-VXR ('00-'04) - DNA ('01)



#### ART. **18017**

Ø stelo girante / rotor rod mm. 12/8

#### PIAGGIO

BEVERLY RST 125 ('06-'07)-VESPA GT 125-200 ('06-'07)  
MP3 125 ('05-'07) - X8 PREMIUM 125-200('05-'06)  
X9 EVOLUTION EURO3 ('07)-X9 EVOLUTION ('03-'07)

#### GILERA

RUNNER VX 4T EURO 3 125 ('07) - NEXUS 125 ('07)

#### APRILIA

SCARABEO 125-200 ('06-'07) - ATLANTIC 125 ('06-'07)



#### ART. **18018**

Ø stelo girante / rotor rod mm. 8

#### PIAGGIO

BEVERLY 250 ('05)



#### ART. **18012**

Ø stelo girante / rotor rod mm. 10

MOTORI MINARELLI - YAMAHA 125-150-180 cc.



#### ART. **18014**

Ø stelo girante / rotor rod mm. 10/8

MOTORI ROTAX 125-150 cc.

#### APRILIA

LEONARDO 125-150 (->'00) - SCARABEO 125-150 (->'00)





## KIT REVISIONE POMPA ACQUA

H<sub>2</sub>O PUMP REVISION KIT



ART. **18020**

Ø stelo girante / rotor rod mm. 14/10  
filetto / thread mm. 7

**HONDA**  
SH 125-150 - CHIOCCIOLA 125-150



ART. **18021**

Ø stelo girante / rotor rod mm. 12  
filetto / thread mm. 7

**HONDA**  
SH 300



ART. **18025**

**YAMAHA**  
X MAX 125 - X CITY 125



ART. **18022**

Ø stelo girante / rotor rod mm. 10

**YAMAHA**  
MAJESTY 250 ('00-'03)









ART. **18024**

Ø stelo girante / rotor rod mm. 12/11

**YAMAHA**  
T MAX 500 ('04-'08)



CIF ART.	MARCA BRAND	RIF. ORIG.	APPLICAZIONI APPLICATIONS
 <p><b>17100</b></p>	<p>MITSUBOSHI</p>	<p>8570124</p> <p>82712R-480852</p>	<p><b>APRILIA</b> SCARABEO 50 4T ('03)</p> <p><b>GILERA</b> DNA 50 ('00-'02) - DNA 50 ('05-'07) - GP EXPERIENCE 50 ('03-'04) TYPHOON 2T EU2 50 ('10-'12)</p> <p><b>ITALJET</b> TORPEDO 50 2T/4T ('00-'03)</p> <p><b>PIAGGIO</b> FLY 50 2T (05-11)-LIBERTY 50 (97-05)-4T 50 (00-08)-50 2T (06-08) LIBERTY RST 50 2T(04) - RST 50 4T('04)-SPORT 50 2T/4T ('06-'08) LIB.PTT EU2 50('04-'05)-PTT 4T 50('07-'15)-MOC 2T/4T ELLE 50 LIB.4T DELIVERY TNT 50 ('09)-4T DELIVERY SINGLE 50 ('10-'14) LIBERTY 4T 3V IE 50('15-17)-IGET 4T 3V IE E4 EMEA 50(17-19) LIB.IGET IGET 4T 3V IE E4 EMEA 25 KM/H 50 (17-19) LIBERTY IGET CORPORATE E4 4T 50 (2018)</p>
 <p><b>17101</b></p>	<p>MITSUBOSHI</p>	<p>431190</p>	<p><b>PIAGGIO</b> QUARTZ 50 ('92-'96) SFERA MAQUILLAGE2 50 ('94) - SFERA RST 50 ('95-'99) VESPA ET2 50 carburatore fino al / carburettor till to 04/1998 ZIP FR 50 ('93-'94) ZIP 50 ('95-'96) ZIP FR RST 50 ('96-'97) ZIP SP 50('96-'00)</p>
 <p><b>17102</b></p>	<p>MITSUBOSHI</p>	<p>430728</p>	<p><b>GILERA</b> TYPHOON 50 ('94-'97) - TYPHOON X 50 ('98-'99) STORM 50 ('94-'95)</p> <p><b>PIAGGIO</b> FREE 50 ('92-'94) - FREE FL 50 ('95-'02) NRG 50 ('94-'96) - NRG RST MC2 ('96-'98) NTT 50 ('95-'96)</p>
 <p><b>17103</b></p>	<p>MITSUBOSHI</p>	<p>830488-478954</p> <p>82645R</p>	<p><b>PIAGGIO</b> VESPA ET2 50 carburatore dal / carburettor since 05/1998 VESPA ET2 INIEZIONE 50 ('97-'00) - VESPA ET4 50 ('00-'05) VESPA LX 2T 50 ('05-'13)- LX 4T 50 ('05-'09) - LX 4T-4V 50 ('09-'13) VESPA LX 4T-4V TOURING 50 ('10-'13) - LXV 2T 50 ('06-'09) VESPA LXV 2T NAVY 50 ('08) - S 2T &amp; COLLEGE 50 ('07-'12) VESPA S 4T-4V &amp; COLLEGE 50 ('08-'12) - ZIP 50 ('00-'04) ZIP 2T 50 ('08-'13) - ZIP 4T 50 ('00-'13) - ZIP SP 50 ('01-'04) ZIP SP EU2 50 ('06-'13)-4T 25 KM-H 50 ('18-'19) ZIP 4T E4 50 ('18-'19) - ZIP 100 ('06-'10)</p>
 <p><b>17104</b></p>	<p>MITSUBOSHI</p>	<p>8515110</p> <p>210436864</p> <p>436864</p>	<p><b>APRILIA</b> MOTO CUSTOM 2T (MOT.PIAGGIO)-50('04-'10) - SR R 50 ('04) SR STREET 50 ('03-'12) - SR INIEZIONE/CARBURATORE 50 ('14) SR R FACTORY 50(04-09)-R FACTORY INIEZIONE/CARB.50(10-14) ATLANTIS 2T 50 ('02) - GP1 50 ('01-'03) - GP1 EU2 50 ('05-'07)</p> <p><b>DERBI</b> JET SET 50 ('01-'03)</p> <p><b>ITALJET</b> ICE 50 ('01-'05) - RUNNER 50 ('97-'00)-RUNNER POGGIALI 50('02)</p> <p><b>GILERA</b> RUNNER PUREJET 50 ('02-'04) - SP 50 ('02-'07) - SP ST 50('08) STALKER 50('97-'08)-NAKED 50('08) - STORM EU2 50('07) TYPHOON 50 ('01-'11) - TYPHOON XR 50 ('00)</p> <p><b>PIAGGIO</b> DIESIS 50('01)- FREE FL 50 ('95-'02)-FREE DELIVERY 50 ('00-'01) NRG RST MC2 50 (96-98)- MC3 50 (01-04) - EXTREME 50 (99-00) NRG POWER DD(05-15) - POWER DD SR.SPECIALE 50 ('07-'12) NRG POWER DT 50('06-'15)-POWER DT SR.SPECIALE 50('07-'08) NRG PUREJET 50 ('02-'04) - VESPA PRIMAVERA 2T 50 ('13-'17) VESPA SPRINT 2T NOABS E2 50 ('14-'17)</p>
 <p><b>17105</b></p>	<p>BANDO</p>	<p>8206109</p> <p>71700300</p> <p>3AA1784100</p>	<p><b>APRILIA</b> AMICO 50('92-'95) - AREA 51 50('98-'00) - GULLIVER 50('95-'98) RALLY AC 50('95-'03)-LC 50('96-'99) - SCARABEO 50 ('93-'05) SR AC/LC 50('93-'96)-SR STEALTH 50('97-'00)-SR WWW 50('97-'01) K2 AC/LC 50 ('98-'99)-NAKED 50 ('01)-491 50 ('98)-PEPE 50 ('99)</p> <p><b>BENELLI</b> ARK AC/LC 50 ('96) - CHRONO 50(95-00) - EIKON 50(98-00)</p> <p><b>BETA</b> QUADRA(95-99) - TEMPO(94-96)</p> <p><b>MALAGUTI</b> CENTRO 50 ('93-'94) - SL 50 ('94-'00) - CIAK 50 ('99) CROSSER 50 ('95-'98) - F12 PHANTOOM AC/LC 50 ('94-'00) F12 RST EU2 50 ('02-'03) - EU2-3 50 ('03-'04) - F15 FIRE FOX RST 50 ('01-'02) - RST EU2 50 ('02-'03)-EU2-3 50 ('03-'04)</p> <p><b>MBK</b> CS MACH G 50 ('02) - CW BOOSTER 50 ('90-'95) - NG 50 ('95-'98) BOOSTER ROCKET 50 ('97-'98)-SPIRIT 50('96-'03) TRACK 50 ('96-'98) - STUNT 50 ('00-'02) - FLIPPER 50 ('98-'02) OVETTO 50 ('97-'03)-NITRO 50 ('97-'03)</p> <p><b>YAMAHA</b> BW'S 50 ('03)-BW'S BUMP 50 ('95-'98)-BW'S NG 50 ('97-'02) BW'S ORIGINAL 50('97-2)-CS JOG R 50('02)-EW SLIDER 50('99-5) YH WHY 50 ('98-'07)-YN NEO'S 50 ('97-'07)-YQ AEROX 50 ('97-'02)</p>















# CINGHIE DI TRASMISSIONE

DRIVING BELTS



CIF ART.	MARCA BRAND	RIF. ORIG.	APPLICAZIONI APPLICATIONS
<b>17131</b> 	MITSUBOSHI	AP.842009 ex 8575042  PI.842009	<b>APRILIA</b> SCARABEO (mot.Piaggio) 125 ('03-'06) - SCARABEO (mot.Piaggio) SCARABEO EU3 125 ('06-'08) SPORT CITY 125 ('04-'06) - SPORT CITY EU3 125 ('06-'08) SPORT CITY CUBE 125 ('08-'10) - SPORT CITY STREET 125 ('12) <b>PIAGGIO</b> BEVERLY 125 ('01-'03) - BEVERLY RST 125 ('04-'07) BEVERLY RST 4T 4V IE EU3 125 ('10-'15) BEVERLY EU3 125 ('07-'08) - EU3 MIC 125 ('07) BEVERLY EU3 SPORT 125 ('07-'08) BEVERLY TOURER EU3 125 ('07-'10) CARNABY 125 ('07-'10) - X 10 4T 4V IE EU3 125 ('12-'13)
<b>17133</b> 	BANDO	23100KGF901	<b>HONDA</b> FES PHANTEON 4T 125 ('03-'05) NES @ CHIOCCIOLA 125 ('00-'06) PEP PS I 125 ('06) S-WING 125 ('07) SES DYLAN 125 ('01-'06) SH 125 ('01-'04) - SH I 125 ('05)
<b>17134</b> 	BANDO	00127541	<b>KYMCO</b> AGILITY R12 125 ('06) - AGILITY R16 125 ('08) MOVIE 125 ('99-'07) - MOVIE XL 125 ('01-'05) PEOPLE 125 ('99) - PEOPLE 150 ('99-'04) PEOPLE S 125 ('05)
<b>17135</b> 	MITSUBOSHI	8580247-841213  R13440941AO 832023-841213  210487170  756528 832023-841213 487170	<b>APRILIA</b> ATLANTIC 125 (03-06)-ATLANTIC EU3 125(10-12)MOJITO 125 (08) SPORT CITY ONE 125 (08)-SPORT CITY ONE 4T EU3 125 (08-11) SR MAX 125 ('11-'14) - SR MOTARD 125 ('12-'14) <b>BENELLI</b> ADIVA 125 ('01) - ADIVA 150 ('99) <b>DERBI</b> BOULERVARD 125-150 ('02-'07) <b>GILERA</b> DNA 125 (00-01) - NEXUS 125 (07) - NEXUS EU3 125 (07-08) NEXUS EU3 IE 125 (08-10) - RUNNER VX 125 (00-06) RUNNER VX 4T EU3 125 (06-07) - VX RACE 125 (06) RUNNER VX SC 125 (06-07) - VX 4T ST EU3 125 ('08-'13) TYPHOON 4T 2V EU3 125 ('10-'11) <b>ITALJET</b> JET SET 125-150 ('02) TORPEDO MOTORE LEADER 125 ('01) - TORPEDO 150 ('00) <b>MALAGUTI</b> MADISON 3 125 ('06-'07) <b>PEUGEOT</b> LOOXOR 125-150 ('02-'03) <b>PIAGGIO</b> FLY 125-150 ('05-'07) - FLY EU3 125/150 ('07-'11) FLY 4T 3V IE EU3 LEM 125 ('12-'13)-4T 3V IE EU3 DT 125 ('13-15) HEXAGON GTX 125 ('00)-LIBERTY 125 ('01-'02)-RST 125('04-'05) LIBERTY RST PTT125(5-11)-SPORT125(06)-SPORT EU3 125(6-08) LIBERTY 4T 125 / 4T EU3 125 (06-07) - SPORT 4T 150 (08) LIBERTY 4T UE3 DELIVERY 125 (07-15) LIBERTY 4T 2V EU3 125 (09-12) - 4T 2V IE PTT 125 (12) LIBERTY 150 4T EU3 (08) - MOC 4T EU3 (09-'13) LIBERTY 150 4T 3V LEM 150 (13-14) - IGET 4T 3V IE 150 (15-19) MP3 125 ('06-'08)-IBRIDO 125('09-'10)-MP3 IE 125 ('08-'09) MP3 IE TOURING 125 ('11-'12) - MP3 YOURBAN ERL 125 (11-13) SKIPPER 4T 125 ('00-'02)-SUPER HEXAGON GTX 125 VESPA 946 4T 3V ABS 125(13-17)-946 4T 3V ABS ARMANI 125(15) VESPA ET4 125 ('99-'02) - GRANTURISMO 125 ('03-'07) VESPA GRANTURISMO EU3 125 (06-07) - GTS EU3 125 (07-12) VESPA GTS 4T IE SUPER 125(09-15)-SUPER IE 4T 3V 150 (14-15) VESPA GTV 125 ('06-'08) - GTV 4T NAVY EU3 125 ('08) VESPA LT 4T 3V IE 150 ('14) - VESPA LX 125/150 ('05-'06) VESPA LX EU3 125/150 ('06-'08) - LX EU3 IE 125/150 ('09-'11) VESPA LX 4T FL 125/150 ('09)-LX 4T EU3 TOURING 125 (10-13) VESPA LX 4T 3V IE TOUR.125 (12-13) - LX TOURING 150(10-12) VESPA LXV 4T EU3/LXV 4T NAVY EU3 125(06-09) VESPA LXV IE 4T 125(10-13) - S 4T EU3 125(07-08) VESPA S 4T IE & COLLEGE 125/150(09-11) - S 4T 3V IE 125 (12) VESPA S 4T 150 (08-09) - X EVO 125 (07-16) X7 EU3 125 (08) - X7 EVO IE EU3 125(09-10) - X8 125(04-06) X8 PREMIUM EU2/EU3 125('06)X8 STREET EU2 125/150 ('06-'07) X9 125 ('01-'02)-X9 EVOLUTION 125 ('03-'06) X9 EVOLUTION EU3 125 ('07) - ZIP 125 ('00-'02)



CIF ART.	MARCA BRAND	RIF. ORIG.	APPLICAZIONI APPLICATIONS
 <b>17155</b>	MITSUBOSHI	8580207-8580246  41700700  822623-833578 840908	<b>APRILIA</b> ATLANTIC 200 ('03-'05) <b>DERBI</b> BOULEVARD 200 ('05-'06) <b>GILERA</b> DNA 180 ('00-'03) - RUNNER VXR 180 ('00-'02) RUNNER VXR 200 ('02-'05) <b>MALAGUTI</b> MADISON R 180('01-'02) - MADISON S 200 ('02-'03) F12 PHANTOM MAX (motore/engine Piaggio) - 200 ('02-'03) <b>PIAGGIO</b> HEXAGON GTX 180 ('00) - SUPER HEXAGON GTX 180 ('01-'02) LIBERTY RST 200 ('04) - 200 ('06) - 4T EU3 200 ('06-'07) LIBERTY SPORT 200 ('06) - 4T SPORT EU3 200 ('06-'07) VESPA GRANTURISMO 200 ('06-'07) - X8 200 ('05-'07) X9 AMALFI 180 ('00-'03) - X9 EVOLUTION 200 ('02-'03)
 <b>17170</b>	MITSUBOSHI	8577059  41700900  B013360-841851	<b>APRILIA</b> SCARABEO(mot.Piaggio) 250 (05-06) - LIGHT 250 (06-08) SCARABEO LIGHT 300 (09-10) - SPORT CITY 250 ('06-'07) SPORT CITY CUBE 250 - 300 ('08) <b>MALAGUTI</b> F12 PHANTOM MAX (Mot.Piaggio) 250('04-'05) MADISON RS 250('04-'05) - MADISON S 250 ('06) <b>PEUGEOT</b> GEOPOLIS 250 ('07) - SATELIS 250 ('07) <b>PIAGGIO</b> BEVERLY 250 (06-07) - RST 250 ('04-'05) BEVERLY RST 4T 4V IE EU3 300 ('10-'15) - CRUISER 250 ('07-'09) BEVERLY IE EU3 250 ('06-'08) - EU3 MIC 250 ('07) BEVERLY SPORT 250 ('06-'08) - TOURER EU3 250 ('07-'09) BEVERLY TOURER EU3 300 ('09-'10) - IE ABS E4 (EMEA) BEVERLY 300(16-19) - BEVERLY RST 4T 4V IE EU3 300 ('10-16) CARNABY CRUISER 300 ('09-'12)
 <b>17172</b>	MITSUBOSHI	8580261  843963-82941R	<b>APRILIA</b> ATLANTIC 250 ('03-'06) - ATLANTIC 300 ('10-'11) SR MAX 300 ('11-'14) <b>GILERA</b> NEXUS 250/300 ('08) - EU3 250 ('06-'07) - EU3 300 ('08-'11) OREGON 250 ('06-'10) <b>PIAGGIO</b> MP3 250 (06-08)-MP3 LT/MIC 250 (08-09)-MP3 IE LT 300 (10-11) MP3 IE MIC 300 (10-11) - MP3 LT BUSINESS 300 ('10-'13) MP3 4T 4V IE LT IBRIDO 300 ('10-'11) MP3 4T 4V IE ERL IBRIDO 300 ('10-'13) - IE TOURING 300 ('11-'12) MP3 IE LT TOURING 300 ('11-13) - IE LT / SPORT 300 ('11-'12) MP3 YOURBAN ERL 300 ('11-'15) - YOURBAN LT ERL 300 ('11-'12) VESPA GT 60 EU3 250 ('06-'07) VESPA GTS ABS 250 ('05-'12) - GTS 250 ('05-'16) VESPA GTS IE TOURING 300 ('11-'15) - GTS SUPER 300 ('08) VESPA GTS SUPER SPORT 300 ('10-'13) VESPA GTV 250 ('06-'09) - GTV 4T NAVY EU3 250 ('07) VESPA GTV VIA MONTENAPOLIONE 300 ('10) VESPA GTV 4T 4V IE 300 ('10-'13) X EVO 250 ('07-'16) - X EVO IE EU3 300 ('09-'10) X7 EU3 250 ('08) - X8 250 ('05-'08) - X8 EU3 250 ('05-'08) X9 (motori HONDA) 250 ('00-'01) - X9 EVOLUTION 250 ('04-'06)
 <b>17174</b>	MITSUBOSHI	4HC176410100	<b>YAMAHA</b> YP MAJESTY 250 ('96-98)
 <b>17175</b>	MITSUBOSHI	71701100  5SEE764100	<b>MALAGUTI</b> PASSWORD 250 ('05) <b>MBK</b> XC KILIBRE 300 ('03-'05) <b>YAMAHA</b> VP X-CITY 250 ('07) YP R X-MAX 250 ('05) XC VERSITY 300 ('03-'06)
 <b>17185</b>	MITSUBOSHI	8560188  832738	<b>APRILIA</b> ATLANTIC SPRINT 400-500 ('05-'08) - ATLANTIC 500 ('01-'04) SCARABEO 500 ('03-'06) - SCARABEO LIGHT 400-500 ('06-'08) <b>GILERA</b> FUOCO 500 ('07) - NEXUS 500 ('03-'06) - NEXUS EU3 500 ('06-'11) NEXUS SP EU3 500 ('06-'07) <b>PEUGEOT</b> SATELIS 400-500 ('07) <b>PIAGGIO</b> BEVERLY 500 ('02-'06) - BEVERLY EU3 400 ('06-'07) BEVERLY EU3 500 ('06-'08) - BEVERLY TOURER EU3 400 ('08-'10) MP3 400 ('07-'08) - MP3 MIC 400 ('08-'10) MP3 IE LT / IE LT SPORT 400 ('08-'10) MP3 IE LT TOURING 400 ('11) - MP3 RL TOURING 400 ('11) X-EVO 400 ('07) - X8 EU3 400 ('06-'08) X9 EVOLUTION 500 ('03-'07) - X9 EVLUTION ABS 500 ('06-'07)





## CINGHIE DI TRASMISSIONE

### DRIVING BELTS



#### (TABELLA PER RICERCA CINGHIA IN BASE AL VEICOLO) (BELTS LIST, SEARCH FOR VEHICLE)

APRILIA	CIF ART.	MARCA BRAND	RIF. ORIGINALE
AMICO 50 ('92-'95) - AREA 51 50 ('98-'00)	17105	BANDO	8206109
ATLANTIC 125 ('03-'06) - ATLANTIC EU3 125 ('10-'12)	17135	MITSUBOSHI	8580247-841213
ATLANTIC 200 ('03-'05)	17155	MITSUBOSHI	8580207-246
ATLANTIC 250 ('03-'06) - ATLANTIC 300 ('10-'11)	17172	MITSUBOSHI	8580261-82941R
ATLANTIC 500 ('01-'04) - ATLANTIC SPRINT 400-500 ('05-'08)	17185	MITSUBOSHI	8560188
GULLIVER 50 ('95-'98)	17105	BANDO	8206109
MOJITO 125 ('08)	17135	MITSUBOSHI	8580247-841213
MOTO CUSTOM 2T (motore PIAGGIO) 50 ('04-'10)	17104	MITSUBOSHI	8515110-436864
RALLY AC 50 ('95-'03) - LC 50 ('96-'99)	17105	BANDO	8206109
SCARABEO 50 ('93-'05)	17105	BANDO	8206109
SCARABEO 50 4T ('03)	17100	MITSUBOSHI	8570124
SCARABEO (motori Piaggio) 125 (03-06) - SCARABEO (motori Piaggio) EU3 125 (06-08)	17131	MITSUBOSHI	842009-8575042
SCARABEO (motori Piaggio) 250 ('05-'06) - SCARABEO LIGHT 250 ('06-'08) - LIGHT 300 ('08)	17170	MITSUBOSHI	8577059
SCARABEO 500 ('03-'06) - SCARABEO LIGHT 400-500 ('06-'08)	17185	MITSUBOSHI	8560188
SPORT CITY 125 ('04-'06) - SPORT CITY EU3 125 ('06-'08) - CUBE 125 ('08-'10) - STREET 125 ('12)	17131	MITSUBOSHI	842009-8575042
SPORT CITY ONE 125 ('08) - SPORT CITY ONE 4T EU3 125 ('08-'11)	17135	MITSUBOSHI	8580247-841213
SPORT CITY 250 ('06-'07) - SPORT CITY CUBE 250-300 ('08)	17170	MITSUBOSHI	8577059
SR AC/LC 50 ('93-'96) - SR STEALTH 50 ('97-'00) - SR WWW 50 ('97-'01)	17105	BANDO	8206109
SR R 50 ('04) - SR STREET 50 ('04) - SR INIEZIONE E CARBURATORE 50 ('14)	17104	MITSUBOSHI	8515110-436864
SR R - R FACTORY 50 (04-09)-SR R FACTORY INIEZIONE E CARBURATORE. 50 (10-14)	17104	MITSUBOSHI	8515110-436864
SR MAX 125 ('11-'14) - SR MOTARD 125 ('12-'14)	17135	MITSUBOSHI	8580247-841213
SR MAX 300 ('11-'14)	17172	MITSUBOSHI	8580261-82941R

BENELLI	CIF ART.	MARCA BRAND	RIF. ORIGINALE
ADIVA 125 ('01) - ADIVA 150 ('99)	17135	MITSUBOSHI	8580247-841213
K2 AC/LC 50 ('98-'99) - NAKED 50 ('01) - 491 50 ('98) - PEPE 50 ('99)	17105	BANDO	

BETA	CIF ART.	MARCA BRAND	RIF. ORIGINALE
ARK AC/LC 50 ('96) - CHRONO 50 ('95-'00) - EIKON 50 ('98-'00) - QUADRA ('95-'99) - TEMPO ('94-'96)	17105	BANDO	

DEARBY	CIF ART.	MARCA BRAND	RIF. ORIGINALE
ATLANTIS 2T 50 ('02)	17104	MITSUBOSHI	
BOULERVARD 125-150 ('02-'07)	17135	MITSUBOSHI	832023-841213
BOULEVARD 200 ('05-'06)	17155	MITSUBOSHI	
GP1 50 ('01-'03) - GP1 E2 50 ('05-'07)	17104	MITSUBOSHI	

GILERA	CIF ART.	MARCA BRAND	RIF. ORIGINALE
DNA 50 ('00-'02) - DNA 50 ('05-'07) - GP EXPERIENCE 50 ('03-'04)	17100	MITSUBOSHI	82712R-480852
DNA 125 ('00-'01)	17135	MITSUBOSHI	832023-841213
DNA 180 ('00-'03)	17155	MITSUBOSHI	833578-840908
FUOCO 500 ('07)	17185	MITSUBOSHI	832738
ICE 50 ('01-'05)	17104	MITSUBOSHI	436864
NEXUS 125 ('07) - NEXUS EU3 125 ('07-'08) - NEXUS EU3 IE 125 ('08-'10)	17135	MITSUBOSHI	832023-841213
NEXUS 250/300 ('08) - NEXUS EU3 250 ('06-'07) - NEXUS EU3 300 ('08-'11)	17172	MITSUBOSHI	843963
NEXUS 500 ('03-'06) - NEXUS EU3 500 ('06-'11) - NEXUS SP EU3 500 ('06-'07)	17185	MITSUBOSHI	832738
RUNNER 50 ('97-'00)-POGGIALI 50 ('02) - PUREJET 50 ('02-'04) - SP 50 ('02-'07) - SP ST 50 ('08)	17104	MITSUBOSHI	436864
RUNNER VX 125 ('00-'06) - VX 4T EU3 125 ('06-'13) - VX RACE 125('06) - VX SC 125 ('06-'07)	17135	MITSUBOSHI	832023-841213
RUNNER VXR 180 ('00-'02) - RUNNER VXR 200 ('02-'05)	17155	MITSUBOSHI	833578-840908
OREGON 250 ('06-'10)	17172	MITSUBOSHI	843963
STALKER 50 ('97-'08) - STALKER NAKED 50 ('08)	17104	MITSUBOSHI	436864



### (TABELLA PER RICERCA CINGHIA IN BASE AL VEICOLO) (BELTS LIST, SEARCH FOR VEHICLE)

GILERA	CIF ART.	MARCA BRAND	RIF. ORIGINALE
TYPHOON 50 ('94-'97) - TYPHOON X 50 ('98-'99)	<b>17102</b>	MITSUBOSHI	430728
TYPHOON XR 50 ('00)	<b>17104</b>	MITSUBOSHI	436864
TYPHOON 2T EU2 50 ('10-'12)	<b>17100</b>	MITSUBOSHI	82712R-480852
TYPHOON 4T 2V EU2 125 ('10-'11)	<b>17135</b>	MITSUBOSHI	832023-841213
STORM 50 ('94-'95)	<b>17102</b>	MITSUBOSHI	430728
STORM EU2 50 ('07)	<b>17104</b>	MITSUBOSHI	436864

HONDA	CIF ART.	MARCA BRAND	RIF. ORIGINALE
FES PHANTEON 4T 125 ('03-'05) - NES @ CHIOCCIOLA 125 ('00-'06) - PEP PS I 125 ('06)	<b>17133</b>	BANDO	23100KGF901
S-WING 125 ('07) - SES DYLAN 125 ('01-'06)	<b>17133</b>	BANDO	23100KGF901
SH 125 ('01-'04) - SH I 125 ('05)	<b>17133</b>	BANDO	23100KGF901

ITALJET	CIF ART.	MARCA BRAND	RIF. ORIGINALE
JET SET 50 ('01-'03)	<b>17104</b>	MITSUBOSHI	210436864
JET SET 125-150 ('02)	<b>17135</b>	MITSUBOSHI	210487170
TORPEDO 50 2T/4T ('00-'03)	<b>17100</b>	MITSUBOSHI	
TORPEDO motori LEADER 125 ('01) - TORPEDO 150 ('00)	<b>17135</b>	MITSUBOSHI	210487170

KYMCO	CIF ART.	MARCA BRAND	RIF. ORIGINALE
AGILITY 50 ('05)	<b>17107</b>	BANDO	00107541
AGILITY R12 125 ('06) - AGILITY R16 125 ('08)	<b>17134</b>	BANDO	00127541
B&W 50 ('01-'03) - DINK 50 ('98-'03)	<b>17107</b>	BANDO	00107541
MOVIE 125 ('99-'07) - MOVIE XL 125 ('01-'05)	<b>17134</b>	BANDO	00127541
PEOPLE 50 ('99) - PEOPLE S 2T 50 ('05) - PEOPLE S 4T 50 ('06)	<b>17107</b>	BANDO	00107541
PEOPLE 125 ('99) - PEOPLE S 125 ('05) - PEOPLE 150 ('99-'04)	<b>17134</b>	BANDO	00127541
SUPER 9 50 ('00-'04) - TOP BOY 50 ('97-'00) - VITALITY 2T/4T 50 ('04) - YUP 50 ('01-'03)	<b>17107</b>	BANDO	00107541

MALAGUTI	CIF ART.	MARCA BRAND	RIF. ORIGINALE
CENTRO 50 ('93-'94) - SL 50 ('94-'00) - CIACK 50 ('99) - CROSSER 50 ('95-'98)	<b>17105</b>	BANDO	71700300
F12 PHANTOM AC/LC 50 ('94-'00)-RST EU2 50 ('02-'03)-EU2-3 50 ('03-'04)	<b>17105</b>	BANDO	71700300
F12 PHANTOM MAX (motori Piaggio) 200 ('02-'03)	<b>17155</b>	MITSUBOSHI	41700700
F12 PHANTOM MAX (motori Piaggio) 250 ('04-'05)	<b>17170</b>	MITSUBOSHI	41700900
F15 FIRE FOX RST 50 ('01-'02) - RST EU2 50 ('02-'03) - EU2-3 50 ('03-'04)	<b>17105</b>	BANDO	71700300
MADISON 3 125 ('06-'07)	<b>17135</b>	MITSUBOSHI	
MADISON R 180 ('01-'02) - MADISON S 200 ('02-'03)	<b>17155</b>	MITSUBOSHI	41700700
MADISON RS 250 ('04-'05) - MADISON 3 250 ('06)	<b>17170</b>	MITSUBOSHI	41700900
PASSWORD 250 ('05)	<b>17175</b>	MITSUBOSHI	71701100

MBK	CIF ART.	MARCA BRAND	RIF. ORIGINALE
BOOSTER CW 50 ('90-'95) - NG 50 ('95-'98) - ROCKET 50 ('97-'98) - BOOSTER SPIRIT 50 ('96-'03)	<b>17105</b>	BANDO	
CS MACH G 50 ('02) - FLIPPER 50 ('98-'02)	<b>17105</b>	BANDO	
KILIBRE XC 300 ('03-'05)	<b>17175</b>	MITSUBOSHI	5SEE764100
NITRO 50 ('97-'03) - STUNT 50 ('00-'02) - TRACK 50 ('96-'98) - OVETTO 50 ('97-'03)	<b>17105</b>	BANDO	

PEUGEOT	CIF ART.	MARCA BRAND	RIF. ORIGINALE
GEOPOLIS 250 ('07)	<b>17170</b>	MITSUBOSHI	
LOOXOR 125-150 ('02-'03)	<b>17135</b>	MITSUBOSHI	756528
SATELIS 250 ('07)	<b>17172</b>	MITSUBOSHI	
SATELIS 400-500 ('07)	<b>17185</b>	MITSUBOSHI	
ZENITH 50 ('94-'98)	<b>17106</b>	BANDO	723590





## CINGHIE DI TRASMISSIONE

### DRIVING BELTS



### (TABELLA PER RICERCA CINGHIA IN BASE AL VEICOLO)

### (BELTS LIST, SEARCH FOR VEHICLE)

PIAGGIO	CIF ART.	MARCA BRAND	RIF. ORIGINALE
BEVERLY 125 ('01-'03) - EU3 125 ('07-'08)	17131	MITSUBOSHI	842009
BEVERLY 250 ('06-'07) - RST 250 ('04-'05) - IE EU3 250 ('06-'08) - EU3 MIC 250 ('07)	17170	MITSUBOSHI	841851
BEVERLY 400 EU3 ('06-'07)	17185	MITSUBOSHI	832738
BEVERLY 500 ('02-'06) - EU3 500 ('06-'08)	17185	MITSUBOSHI	832738
BEVERLY CRUISER 250 ('07-'09)	17170	MITSUBOSHI	841851
BEVERLY MIC EU3 125 ('07)	17131	MITSUBOSHI	842009
BEVERLY RST 125 ('04-'07) - RST 4T 4V IE EU3 125 ('10-'15) -	17131	MITSUBOSHI	842009
BEVERLY RST 4T 4V IE EU3 300 ('10-'15)	17170	MITSUBOSHI	841851
BEVERLY SPORT EU3 125 ('07-'08)	17131	MITSUBOSHI	842009
BEVERLY SPORT 250 ('06-'08)	17170	MITSUBOSHI	841851
BEVERLY TOURER EU3 125 ('07-'10)	17131	MITSUBOSHI	842009
BEVERLY TOURER EU3 250 ('07-'09) - TOURER EU3 300 ('09-'10)	17170	MITSUBOSHI	841851
BEVERLY TOURER EU3 400 ('08-'10)	17185	MITSUBOSHI	832738
CARNABY 125 ('07-'10)	17131	MITSUBOSHI	842009
FLY 50 2T ('05-'07)	17100	MITSUBOSHI	82712R-480852
FLY 125/150 ('05-'07)-EU3 125/150 ('07-'11)-4T 3V IE EU3 LEM 125 ('12-'13)-4T 3V IE EU3 DT 125 ('13-'15)	17135	MITSUBOSHI	832023-841213
LIBERTY 50 ('97-'05) - 50 2T ('06-'08) - 50 4T ('00-'08)	17100	MITSUBOSHI	82712R-480852
LIBERTY 125 ('01-'02) - 4T 125 ('06-'07) - 4T EU3 125 ('07-'08) - 4T 2V EU3 125 ('09-'12)	17135	MITSUBOSHI	832023-841213
LIBERTY 150 EU3 4T ('08) - LIBERTY 150 4T 3V LEM ('13-'14)	17135	MITSUBOSHI	832023-841213
LIBERTY 200 ('06) - LIBERTY 4T EU3 200 ('06-'07)	17155	MITSUBOSHI	833578-840908
LIBERTY DELIVERY 4T TNT 50 ('09) - DELIVERY 4T SINGLE 50 ('10-'14)	17100	MITSUBOSHI	82712R-480852
LIBERTY DELIVERY 4T EU3 125 ('07-'15)	17135	MITSUBOSHI	832023-841213
LIBERTY IGET 4T 3V IE 50 ('15-'17) - IGET 4T 3V IE E4 EMEA 50 ('17-'19)	17100	MITSUBOSHI	82712R-480852
LIBERTY IGET 4T 3V IE E1 EMEA 25 KM/H 50('17-'19) - IGET CORPORATE E4 4T 50 (2018)	17100	MITSUBOSHI	82712R-480852
LIBERTY IGET 4T 3V IE 150 ('15)	17135	MITSUBOSHI	832023-841213
LIBERTY MOC 2T/4T ELLE 50 ('09-'16)	17100	MITSUBOSHI	82712R-480852
LIBERTY PTT EU2 50 ('04-'05) - PTT 4T 50 ('07-'15) - PTT 4T 2V IE 125 ('12) - RST 50 2T/4T ('04)	17100	MITSUBOSHI	82712R-480852
LIBERTY RST 125 ('04-'05) - RST PTT 125 ('05-'11)	17135	MITSUBOSHI	832023-841213
LIBERTY RST 200 ('04-'07)	17155	MITSUBOSHI	833578-840908
LIBERTY SPORT 50 2T/4T ('06-'08)	17100	MITSUBOSHI	82712R-480852
LIBERTY SPORT 125 ('06) - SPORT EU3 125 ('06-'08)	17135	MITSUBOSHI	832023-841213
LIBERTY SPORT 200 ('06) - SPORT 4T EU3 200 ('06-'07)	17155	MITSUBOSHI	833578-840908
DIESIS 50 ('01)	17104	MITSUBOSHI	436864
FREE 50 ('92-'94) - FL 50 ('95-'02)	17102	MITSUBOSHI	430728
FREE FL 50 (MY02) ('95-'02) - FREE DELIVERY 50 ('00-'01)	17104	MITSUBOSHI	436864
HEXAGON GTX 125 ('00)	17135	MITSUBOSHI	832023-841213
HEXAGON GTX 180 ('00)	17155	MITSUBOSHI	833578-840908
MP3 125 ('06-'08)-MP3 IBRIDO 125('09-'10)- MP3 IE 125 ('08-'09)- MP3 IE TOURING 125 ('11-'12)	17135	MITSUBOSHI	832023-841213
MP3 YOURBAN ERL 125('11-'13)	17135	MITSUBOSHI	832023-841213
MP3 250 ('06-'08) - MP3 LT/MIC 250 ('08-'09) - MP3 300 IE LT ('10-'11) - MP3 IE MIC 300 ('10-'11)	17172	MITSUBOSHI	843963
MP3 LT BUSINESS 300 ('10-'13) - 4T 4V IE LT IBRIDO 300 ('10-'11)-4T 4V IE ERL IBRIDO 300 ('10-'13)	17172	MITSUBOSHI	843963
MP3 IE TOURING 300 ('11-'12)- IE LT TOURING 300 ('11-'13) - IE LT / SPORT 300 ('11-'12)	17172	MITSUBOSHI	843963
MP3 YOURBAN ERL 300 ('11-'15) - MP3 YOURBAN LT ERL 300 ('11-'12)	17172	MITSUBOSHI	843963
MP3 400 ('07-'08)-MIC 400('08-'10)-IE LT/SPORT 400('08-'10)-IE LT TOURING 400('11)-RL TOUR.400('11)	17185	MITSUBOSHI	832738
NRG 50 ('94-'96) - NRG RST MC2 ('96-'98)	17102	MITSUBOSHI	430728
NRG RST MC2 50 ('96-'98) - NRG MC3 50 ('01-'04) - NRG EXTREME 50('99-'00) -	17104	MITSUBOSHI	436864
NRG POWER DD ('05-'15) - NRG POWER DD SR.SPECIALE 50('07-'12)-NRG POWER DT 50('06-'15)	17104	MITSUBOSHI	436864
NRG DT SR.SPEC.50('07-'08) - NRG PUREJET50 (02-'04)	17104	MITSUBOSHI	436864
NTT 50 ('95-'96)	17102	MITSUBOSHI	430728
QUARTZ 50 ('92-'96)	17101	MITSUBOSHI	431190
SFERA MAQUILLAGE2 50 ('94) - SFERA RST 50 ('95-'99)	17101	MITSUBOSHI	431190
SKIPPER 4T 125 ('00-'02)	17135	MITSUBOSHI	832023-841213
SUPER HEXAGON GTX 125 ('01-'02)	17135	MITSUBOSHI	832023-841213
SUPER HEXAGON GTX 180 ('01-'02)	17155	MITSUBOSHI	833578-840908



**(TABELLA PER RICERCA CINGHIA IN BASE AL VEICOLO)**  
**(BELTS LIST, SEARCH FOR VEHICLE)**

PIAGGIO	CIF ART.	MARCA BRAND	RIF. ORIGINALE
VESPA 946 4T 3V ABS 125 ('13-'15) - VESPA 946 4T 3V ABS ARMANI 125 ('15)	<b>17135</b>	MITSUBOSHI	832023-841213
VESPA ET2 50 carburatore fino al 04/1998	<b>17101</b>	MITSUBOSHI	431190
VESPA ET2 50 carburatore dal 05/1998 - ET2 INIEZIONE 50 ('97-'00)	<b>17103</b>	MITSUBOSHI	82645R-478954
VESPA ET4 50 ('00-'05)	<b>17103</b>	MITSUBOSHI	82645R-478954
VESPA ET4 125-150 ('00-'04)	<b>17135</b>	MITSUBOSHI	832023-841213
VESPA GRANTURISMO 125 ('03-'06) - GRANTURISMO EU3 125 ('06-'07)	<b>17135</b>	MITSUBOSHI	832023-841213
VESPA GRANTURISMO 200 ('06-'07)	<b>17155</b>	MITSUBOSHI	833578-840908
VESPA GT 60 EU3 250 ('06-'07)	<b>17172</b>	MITSUBOSHI	843963
VESPA GTS EU3 125 ('07-'12) - GTS SUPER IE 4T125 ('09-'15) - GTS SUPER IE 4T 3V 150 ('14-'15)	<b>17135</b>	MITSUBOSHI	832023-841213
VESPA GTS 250 ('05-'16) - VESPA GTS ABS 250 ('05-'12)	<b>17172</b>	MITSUBOSHI	843963
VESPA GTS IE TOURING 300 ('11-'15) - GTS SUPER 300 ('08) - GTS SUPER SPORT 300 ('10-'13)	<b>17172</b>	MITSUBOSHI	843963
VESPA GTV 125 ('06-'08) - GTV 4T NAVY EU3 125 ('08)	<b>17135</b>	MITSUBOSHI	832023-841213
VESPA GTV 250 ('06-'09) - GTV 4T NAVY EU3 250 ('07)	<b>17172</b>	MITSUBOSHI	843963
VESPA GTV VIA MONTENAPOLEONE 300 ('10) - GTV 4T 4V IE 300 ('07)	<b>17172</b>	MITSUBOSHI	843963
VESPA LT 4T 3V IE 150 ('14)	<b>17135</b>	MITSUBOSHI	832023-841213
VESPA LX 2T 50 ('05-'13) - LX 4T 50 ('05-'09) - LX 4T-4V 50 ('09-'13) - LX 4T-4V TOURING 50 ('10-'13)	<b>17103</b>	MITSUBOSHI	82645R-478954
VESPA LX 125/150 (05-06)-LX EU3 125/150 (06-08)-LX EU3 IE 125/150 (09-11)-LX 4T FL 125/150 (09)	<b>17135</b>	MITSUBOSHI	832023-841213
VESPA LX 4T EU3 TOURING 125 (10-13)-LX 4T 3V IE TOURING 125 (12-13)-LX TOURING 150 (10-12)	<b>17135</b>	MITSUBOSHI	832023-841213
VESPA LXV 2T 50 ('06-'09) - LXV 2T NAVY 50 ('08)	<b>17103</b>	MITSUBOSHI	82645R-478954
VESPA LXV 4T EU3 / LXV 4T NAVY EU3 125 ('06-'09) - LXV IE 4T 125 ('10-'13)	<b>17135</b>	MITSUBOSHI	832023-841213
VESPA PRIMAVERA 2T 50 ('13-'15)	<b>17104</b>	MITSUBOSHI	436864
VESPA S 2T & COLLEGE 50 ('07-'12) - VESPA S 4T 4V & COLLEGE 50 ('08-'12)	<b>17103</b>	MITSUBOSHI	82645R-478954
VESPA S 4T EU3 125(07-08)-S 4T 3V IE 125(12)-S 4T IE & COLLEGE 125/150(09-11)-S 4T 150 (08-09)	<b>17135</b>	MITSUBOSHI	832023-841213
VESPA SPRINT 2T 2V 50 ('14-'15)	<b>17104</b>	MITSUBOSHI	436864
X7 EU3 125 ('08) - X7 EU3 125 ('08) - X7 EVO IE EU3 125 ('09-'10)	<b>17135</b>	MITSUBOSHI	832023-841213
X7 250 ('08)	<b>17172</b>	MITSUBOSHI	843963
X8 125 ('04-'06) - PREMIUM EU2 125 ('06) - PREMIUM EU3 125 ('06-'07)	<b>17135</b>	MITSUBOSHI	832023-841213
X8 STREET EU2 125 ('06) - STREET EU2 150 ('06-'07) - X8 150 ('05-'08)	<b>17135</b>	MITSUBOSHI	832023-841213
X8 200 ('05-'07)	<b>17155</b>	MITSUBOSHI	833578-840908
X8 250 ('05-'08) - X8 EU3 250 ('05-'08)	<b>17172</b>	MITSUBOSHI	843963
X8 400 ('06-'08)	<b>17185</b>	MITSUBOSHI	832738
X9 125 ('01-'02) - X9 EVOLUTION 125 ('03-'06) - EVOLUTION EU3 125 ('07)	<b>17135</b>	MITSUBOSHI	832023-841213
X9 EVOLUTION 200 ('02-'03) - X9 AMALFI 180 ('00-'03)	<b>17155</b>	MITSUBOSHI	833578-840908
X9 EVOLUTION 250 ('04-'06) - X9 motori / engine Honda 250 ('00-'01)	<b>17172</b>	MITSUBOSHI	843963
X9 EVOLUTION 500 ('03-'07) - X9 EVOLUTION ABS 500 ('06-'07)	<b>17185</b>	MITSUBOSHI	832738
X10 4T 4V IE EU3 125 ('12-'13)	<b>17131</b>	MITSUBOSHI	842009
X EVO 125 ('07-'16)	<b>17135</b>	MITSUBOSHI	832023-841213
X EVO 250 ('07-'16) - X-EVO IE EU3 300 ('09-'10)	<b>17172</b>	MITSUBOSHI	843963
X EVO 400 ('07)	<b>17185</b>	MITSUBOSHI	832738
ZIP 50 ('95-'96) - FAST RIDER 50 ('93-'94) - FAST RIDER RST 50 ('96-'97) - SP 50('96-'00)	<b>17101</b>	MITSUBOSHI	431190
ZIP 50 ('00-'04) - 2T 50 ('08-'13) - 4T 50 ('00-'13)-SP 50('01-'04)-SP EU2 50 ('06-'13) - ZIP 100 ('06-'10)	<b>17103</b>	MITSUBOSHI	82645R-478954
ZIP 125 ('00-'02)	<b>17135</b>	MITSUBOSHI	832023-841213

YAMAHA	CIF ART.	MARCA BRAND	RIF. ORIGINALE
AEROX YQ 50 ('97-'02)	<b>17105</b>	BANDO	3AA1764100
BW'S 50 ('03)-BW'S BUMP 50 ('95-'98)-BW'S NG 50 ('97-'02)-BW'S ORIGINAL 50 ('97-'02)	<b>17105</b>	BANDO	3AA1764100
JOG R 50 ('02)	<b>17105</b>	BANDO	3AA1764100
MAJESTY YP 250 ('96-'98)	<b>17174</b>	MITSUBOSHI	4HC176410100
NEO'S 50 ('97-'07) - SLIDER 50 ('99-'05)	<b>17105</b>	BANDO	3AA1764100
VERSITY XC 300 ('03-'06)	<b>17175</b>	MITSUBOSHI	5SEE764100
X-MAX 125 ('06)	<b>17105</b>	BANDO	3AA1764100
X-MAX YP R 250 ('05) - X-CITY VP 250 ('07)	<b>17175</b>	MITSUBOSHI	5SEE764100
WHY 50 ('98-'07)	<b>17105</b>	BANDO	3AA1764100



## CINGHIETTE PER MISCELATORE

SMALL BELTS FOR AUTOMATIC MIX



### ART. 5400-MIX

CINCHIETTA PER MISCELATORE AUTOMATICO  
SMALL BELT FOR AUTOMATIC MIX

(Sim. 286182)

#### PIAGGIO

DIESIS 50  
FLY 2T  
FREE - FREE DELIVERY - FREE FL  
LIBERTY - LIBERTY 2T - LIBERTY PTT EU2  
NRG - NRG EXTREME - NRG POWER  
NTT  
QUARTZ  
SFERA - SFERA RST  
VESPA ET2 - VESPA LX 2T - VESPA LX 2T TOURING & 30KM  
VESPA LXV 2T - VESPA LXV 2T NAVY  
VESPA PRIMAVERA 2T  
VESPA S 2T & COLLEGE  
VESPA SPRINT 2T NO ABS E2  
ZIP  
ZIP 2T  
ZIP BIMODALE  
ZIP FAST RAIDER - ZIP FAST RAIDER RST  
ZIP RST  
ZIP SP 50  
ZIP SP EU2

#### GILERA

DNA 50  
GP EXPERIENCE  
EASY MOVING  
ICE  
RUNNER - POGGIALI - RUNNER PUREJET - RUNNER SP  
STALKER - STALKER NAKED  
STORM - STORM EU2  
TYPHOON - TYPHOON 2T EU2  
TYPHOON - TYPHOON 2T EU3 CH - TYPHOON 2T EU4



### ART. 5401-MIX

CINCHIETTA PER MISCELATORE AUTOMATICO  
SMALL BELT FOR AUTOMATIC MIX

(Sim. 431370)

#### PIAGGIO

HEXAGON 125-150 ('94-'97)  
HEXAGON LX-LXT 125-180 ('88-'99)  
SKR CITY 80 ('99)  
SKIPPER 125-150 ('94-'97)  
SKIPPER LX 125-150 ('98-'99)

#### GILERA

RUNNER FX-FXR 125-180 ('97-'02)  
TYPHOON 125 ('95-'98)  
TYPHOON X-XR 125 ('99-'00)

## BOCCOLI AVVIAMENTO

### STARTER BUSHINGS



ART. **8202**

BOCCOLO AVVIAMENTO DENTATO **FORO PICCOLO**  
STARTER BUSHING, **SMALL HOLE**

(Sim.435027)

Ø interno / internal mm. 14,7

**APRILIA**  
MOJITO RETRO  
CUSTOM 125 ('99-'01)

**PIAGGIO**  
HEXAGON LX4 125 ('98-'99)  
LIBERTY 125 ('98-'00)  
SFERA 125 ('95-'97)  
VESPA ET4 125 ('96-'98)



ART. **8204**

BOCCOLO AVVIAMENTO DENTATO **FORO GRANDE**  
STARTER BUSHING, **BIG HOLE**

(Sim.478032)

Ø interno / internal mm. 17

**APRILIA**  
SR 125 ('99-'01)

**GILERA**  
RUNNER FX-FXR 125-180 ('97-'02)  
TYPHOON 125 ('95-'98)  
TYPHOON X-XR 125 ('99-'00)

**PIAGGIO**  
HEXAGON 125 ('94-'97)  
HEXAGON LX-LXT 125 ('98-'99)  
SKIPPER 125 ('94-'97)  
SKIPPER LX 125 ('99)  
VESPA ET4 125 ('99-'02)





## PULEGGIA ANTERIORE FISSA

FRONT FIXED PULLEY

### MOTORI MINARELLI - YAMAHA



ART. **8185**

SEMIPULEGGIA ANTERIORE FISSA (IN ALLUMINIO)  
*FIXED FRONT HALF-PULLEY (ALLUMINIUM)*

MOTORI MINARELLI - YAMAHA

(Rif. Minarelli 6005050 - Yamaha 3VL E7611 00)



ART. **8188**

RONDELLA DENTATA DI TRAINO PER SEMIPULEGGIA FISSA  
*FIXED HALF PULLEY THOOOTHED WASHER*

MOTORI MINARELLI - YAMAHA

(Rif. Minarelli 2606707 - Yamaha 9021413055)



ART. **8187**

GHIERA DENTATA PER INGRANAGGIO AVVIAMENTO  
*RING FOR STARTER GEAR*

MOTORI MINARELLI - YAMAHA

(Rif. Minarelli 2602717 - Yamaha 3VL E5657 00)



ART. **8186**

INGRANAGGIO MESSA IN MOTO  
*GEAR STARTING*

MOTORI MINARELLI - YAMAHA

(Rif. Minarelli 4006590 - Yamaha 3AA 156 3100)

## SEMIPULEGGIA MOTRICE HALF PULLEY

### PIAGGIO-GILERA

#### PIAGGIO

FREE 50 ('92-'94) - FREE FL 50 ('95-'02) - NRG 50 ('94-'96) - NRG RST MC2 50 ('96-'98) - NTT 50 ('95-'96) - QUARTZ 50 ('92-'96)  
 SFERA MAQUILLAGE2 50 ('94) - SFERA RST 50 ('95-'97) - VESPA ET2 50 ('97-'05) - ZIP 50 ('95-'96) - ZIP BIMODALE 50 ('94-'97)  
 ZIP FAST RIDER 50('93-'94) -- ZIP RST 50 ('96-'97) - ZIP RST 50 ('96-'99) - ZIP SP 50 ('96-00)

#### GILERA

EASY MOVING 50 ('95-'96) - STORM 50 ('94-'95) - TYPHOON 50 ('94-'97) - TYPHOON X 50 ('98-'99)



#### ART. **8200-KT**

KIT SEMIPULEGGIA MOTRICE  
HALF PULLEY KIT

#### KIT Composto da / Kit composed of:

CIF ART.	Pz/Pcs	Descrizione / Description
5191	1	Dado / Nut
8200	1	Semipuleggia / Half pulley
8199-V	1	Ventola per semipuleggia / Driven half pulley fan
8195-4M	1	Boccolo per ventola / Ringlet sec, fun



#### ART. **8200**

SEMIPULEGGIA MOTRICE DENTATA  
DRIVEN HALF PULLEY

(Sim. 289831)



#### ART. **8199-V**

VENTOLA PER SEMIPULEGGIA MOTRICE DENTATA  
DRIVEN HALF PULLEY FUN

(Sim. 287044)



#### ART. **8195-4M**

BOCCOLO (mm.4)  
PER VENTOLA SEMIPULEGGIA MOTRICE DENTATA  
RINGLET SEC.FUN (mm.4)

(Sim. 433862)





## SEMIPULEGGIA MOTRICE

HALF PULLEY

### PIAGGIO-GILERA

#### PIAGGIO:

DIESIS 50 (01) - FLY 2T 50 (05-07) - FLY 4T 50 (08) - FLY 4T MOTORE CHIN 50 (06-07) - FLY 4T 100 (06-08) - FREE 50 (92-94) - FREE FL 50 (95-02) - FREE DELIVERY 50 (00-01) - LIBERTY 50 (97-05) - 2T 50(06-08) - 4T 50 (00-08) - RST 2T/4T 50 (04) - SPORT 2T /4T 50 (06-08) - PTT EU2 50 (04-05) - NRG EXTREME 50(99-00) - MC3 50 (01-04) - POWER DD/DT 50 (05-08) - POWER PUREJET 50 (04-08) - PUREJET 50 (02-04) - RST MC2 50 (96-98) - VESPA ET2 INIEZIONE 50 (97-00) - ET4 50 (00-05) - LX 2T 50(05-08) - LX 4T 50(05-08) - LXV 2T 50 (06-08) - LXV 2T NAVY 50 (08) -S 2T 50 (07-08) - ZIP 50 (00-04) - ZIP 4T 50 (00-08) - ZIP 4T 100 (06-08) - ZIP SP 50 (01-04) - ZIIP SP EU2 50 (06-08)

#### GILERA:

DNA 50 (00-02/05-07) - GP EXPERIENCE 50 (03-04) - ICE 50 (01-05) - RUNNER 50 (97-00) - POGGIALI 50 (02) - PUREJET 50 (02-07) - SP 50 (02-07) - RUNNER SP EDIZ.SPEC.50 (07) - SP ST 50 (08) - STALKER 50 (97-08)-EDIZ.SPEC.50(07-08)-NAKED 50(08)-STORM EU2 50(07) - TYPHOON 50 (01-08) - TYPHOON XR 50 (00)



ART. **8203-KT**

KIT SEMIPULEGGIA MOTRICE

HALF PULLEY KIT

#### KIT Composto da / Kit composed of:

CIF ART.	Pz/Pcs	Descrizione / Description
5191	1	Dado / Nut
8203	1	Semipuleggia / Half pulley
8198-V	1	Ventola per semipuleggia / Driven half pulley fan
8196	1	Boccolo per ventola / Ringlet sec, fun



ART. **8203**

SEMIPULEGGIA MOTRICE DENTATA

DRIVEN HALF PULLEY

(Sim. 479561)



ART. **8198-V**

VENTOLA PER SEMIPULEGGIA MOTRICE DENTATA

DRIVEN HALF PULLEY FUN

(Sim. 845611-480410)



ART. **8196**

BOCCOLO (mm.4)

PER VENTOLA SEMIPULEGGIA MOTRICE DENTATA

RINGLET SEC.FUN (mm.4)

(Sim. 479866)



## SEMIPULEGGIA MOTRICE

### HALF PULLEY



ART. **8208**

SEMIPULEGGIA MOTRICE FISSA

(Sim.8456075 - 485118)

#### GILERA

NEXUS EU3 125 ('07-'08)-RUNNER 4T ST EU3 125 ('08-'13)-VX 125 ('05-'06)-VX 4T EU3 125 ('06-'07)  
RUNNER VX RACE 125 ('06) - VX SC 125 ('06-'07) - TYPHOON 4T 2V EU3 125 ('10-'11)

#### PIAGGIO

BEVERLY EU3 125 ('07) - BEVERLY EU3 MIC 125 ('07) - BEVERLY EU3 SPORT 125 ('07)  
BEVERLY RST 125 ('05-'07) - BEVERLY TOURER EU3 125 ('07-'10) - CARNABY 125 ('07-'10)  
FLY 125-150 ('05-'07) - FLY EU3 125 ('07-'11) - FLY EU3 150 ('08-'11) - HEXAGON GTX 125-180 ('00)  
LIBERTY 125 ('01-'02) - 4T 125 ('06-'07) - 4T EU3 125 ('06-'08) - 4T 2V EU3 125 ('09-'12)  
LIBERTY 4T 2V IE PTT 125 ('12-'13) - 4T EU3 150 ('08) - 4T EU3 DELIVERY 125 ('07-'15)  
LIBERTY SPORT 125 ('06) - 4T SPORT EU3 125 ('06-'08) - 4T SPORT EU3 150 ('08)  
LIBERTY MOC 4T EU3 150 ('09-'13) - RST PTT 125 ('05-'11) - MP3 125 ('06-'08)  
SKIPPER 4T 125 ('00-'02)-SUPER HEXAGON GTX 12" 125-180 ('01-'02)-V. ET4 125-150 ('09-'02)  
VESPA GRANTURISMO 125 ('03-'07) - GRANTURISMO EU3 125 ('06-'07) - GTS EU3 125 ('07-'12)  
VESPA GTV 125 ('06-'08) - GTV 4T NAVY EU3 125 ('08) - VESPA LX 125-150 ('05-'06)  
VESPA LX EU3 125-150 ('06-'08) - LX EU3 IE 125-150 ('09-'11) - LX 4T FL 125/150 ('09)  
VESPA LX 4T TOURING EU3 125 ('10-'11) - LX TOURING 150 ('10-'12) - LXV 4T EU3 125 ('06-'09)  
VESPA LXV 4T NAVY EU3 125 ('07-'08) - LXV IE 4T 125 ('10-'13) - VESPA S 4T EU3 125 ('07-'08)  
VESPA S 4T 150 ('08-'09) - S 4T IE & COLLEGE 125/150 ('09-'12) - X EVO 125 ('07-'16)  
X7 EU3 125 ('08) - X8 125 ('05-'06) - X8 PREMIUM EU2 ('06) - X8 PREMIUM EU3 125 ('06-'07)  
X8 STREET EU2 125 ('06-'07) - X8 STREET EU2 150 ('06-'08) - X9 EVOLUTION 125 ('05-'06)  
X9 EVOLUTION EU3 125 ('07) - ZIP 125 ('00-'02)

ART. **8209**

SEMIPULEGGIA MOTRICE FISSA

(Sim.834774-832720-AP.8575027)



#### APRILIA

ATLANTIC 125 ('03-'05) - SCARABEO 125 ('03) - SCARABEO MOT PIAG.EU3 125 ('06)  
SPORT CITY 125 ('04-'06) - SPORT CITY EU3 125 ('06-'08) - SPORT CITY CUBE 125 ('08-'10)

#### GILERA

RUNNER VX 125 ('02-'04) - VXR 200 ('05-'06) - VXR EU3 200 ('07) - VXR 4T ST EURO3 200 ('08)  
RUNNER VXR RACE 200 ('05-'06)

#### PIAGGIO

BEVERLY 125 ('01-'03) - CARNABY 200 ('07-'08) - HEXAGON GTX 125/180 ('00)  
LIBERTY 200 ('06) - LIBERTY RST 200 ('04) - LIBERTY 4T EU3 200 ('06-'08)  
LIBERTY SPORT 200 ('06) - LIBERTY 4T SPORT EU3 200 ('06-'07)  
SUPER HEXAGON GTX 12" 125-180 ('01-'02)  
VESPA GRANTURISMO 125 ('03-'05) - GRANTURISMO 200 ('06-'07)  
X8 125 ('04) - 200 ('05-'07) - X9 200 ('02-'03) - X9 AMALFI 180 ('00-'03) - X9 EVOLUTION 200 ('03)

ART. **8210**

SEMIPULEGGIA MOTRICE FISSA

(Sim.840193-AP.8577053)



#### APRILIA

ATLANTIC 125 ('03-'05) - EU3 125 ('06-'08) - 300 ('10-'11)  
SCARABEO 125 ('04-'06) - SCARABEO LIGHT 250 ('06-'08) - LIGHT 300 ('09-'10)  
SPORT CITY EU3 125 ('06-'08) - SPORT CITY CUBE 250 ('08-'12) - SPORT CITY STREET 300 ('12)  
SR MAX 300 ('11-'14)

#### DERBI

GP1 250 ('06-'07) - RAMBLA 250 ('08)

#### GILERA

NEXUS EU3 250 ('06-'07) - EU3 300 ('08-'11) - SP EU3 250 ('06-'07) - OREGON 250 ('06-'10)

#### PIAGGIO

BEVERLY 250 ('06) - IE EU3 250 ('06-'08) - CRUISER 250 ('07-'09) - MIC EU3 250 ('07) - RST 250 ('04-'05)  
BEVERLY RST 4T 4V IE EU3 300 ('10-'15) - SPORT 250 ('06-'08) - TOURER EU3 250 ('07-'09)  
BEVERLY TOURER EU3 300 ('09-'10) - CARNABY 250 ('08) - CARNABY CRUISER 300 ('09-'12)  
MP3 250 ('06-'08) - LT 250 ('08-'09) - LT IE 300 ('10-'11) - MIC 250 ('08-'09) - MIC IE 300 ('10-'11)  
MP3 LT BUSINESS-SPORT ABS-ENJOY 300 ('14-'15) - 4T 4V IE LT IBRIDO 300 ('10-'11)  
MP3 4T 4V IE ERL IBRIDO 300 ('10-'13) - IE LT TOURING 300 ('11-'13) - IE LT IE LT SPORT 300 ('11-'14)  
MP3 IE TOURING 300 ('11-'12) - YOURBAN ERL 300 ('11-'15) - YOURBAN LT ERL 300 ('11-'12)  
VESPA GT 60 EU3 250 ('06-'08) - GTS 250 ('05-'16) - GTS ABS 250 ('05-'12) - GTS IE TOURING 300 ('11-'16)  
GTS SUPER 300 ('08-'15) - GTS SUPER SPORT 300 ('10-'13) - GTV 250 ('06-'09)  
GTV 4T NAVY EU3 250 ('07) - GTV 4T 4V IE 300 ('10-'13) - GTV MONTENAPOLONE 300 ('10)  
X EVO 250 ('07-'16) - X7 EU3 250 ('08) - X7 EVO IE EU3 300 ('09-'10) - X8 EU3 250 ('05-'08)  
X9 EVOLUTION 250 ('04-'06)





## PATTINI SLIDERS

### PIAGGIO-GILERA 50 cc.



ART. **10440**

PATTINO PER COPERCHIO CONTENITORE RULLI PULEGGIA MOTRICE (Sim. 289931)  
*SLIDER FOR ROLLER WEIGHT HOUSING*

**PIAGGIO**

DIESIS - FLY 2T-4T - FREE-LIBERTY-NRG EXTREME  
VESPA ET2 INIEZIONE - VESPA ET4 - VESPA LX 2T 4T - VESPA S 2T - ZIP

**GILERA**

DNA - GP EXPERIENCE - ICE - RUNNER - POGGIALI - PUREJET - STALKER  
STALKER NAKED - STORM EURO2 TYPHOON 50 - XR 50



ART. **10441**

PATTINO PER COPERCHIO CONTENITORE RULLI PULEGGIA MOTRICE (Sim. 285396)  
*SLIDER FOR ROLLER WEIGHT HOUSING*

**PIAGGIO**

SFERA 50 BASE ('91-'93) - ZIP BASE 50 ('92-'94)

### PIAGGIO-GILERA 125 cc.



ART. **10442**

PATTINO PER COPERCHIO CONTENITORE RULLI PULEGGIA MOTRICE (Sim. 431280)  
*SLIDER FOR ROLLER WEIGHT HOUSING*

**APRILIA**

SR 125 ('99-'01)

**PIAGGIO**

HEXAGON 125-150 ('94-'97) - HEXAGON LX - LXT 125-180 ('98-'99)  
SKIPPER 125-150 ('94-'97) - SKIPPER LX 125-150 ('98-'99)

**GILERA**

RUNNER FX-FXR 125-180 ('97-'00) - TYPHOON 125 ('95-'98) - TYPHOON X - XR 125 ('99-'00)

### APRILIA 125 cc. - PIAGGIO-GILERA 125/150/180/200 cc.



ART. **10443**

PATTINO PER COPERCHIO CONTENITORE RULLI PULEGGIA MOTRICE (Sim. 434855.5)  
*SLIDER FOR ROLLERS WEGHT HOUSING*

**APRILIA**

ATLANTIC EU3 125 - MOJITO 125 - SCARABEO IE LIGHT 125- SPORT CITY CUBE 125  
SPORT CITY ONE 4T EU3 125 - SR MOTARD 125

**PIAGGIO**

BEVERLY - CARNABY - FLY - HEXAGON GTX - LIBERTY-MP3 - SKIPPER - SUPER HEXAGON GTX  
VESPA ET4- VESPA GRANTURISMO - GTS - LX - S 4T - X EVO-X7-X8-X9-X 10 - ZIP

**GILERA**

DNA 125-180 - NEXUS EURO3 125 - RUNNER 4T - RUNNER VX 125 - VXR - VXR RACE 200

## KIT RULLI DI CONTRASTO

ROLLERS SET



### HIGH PERFORMANCE

PARTE METALLICA IN OTTONE O ALLUMINIO  
RIVESTIMENTO ESTERNO IN  
MESCOLA SPECIALE AUTOLUBRIFICANTE

METALLIC PART IN BRASS OR ALUMINUM  
OUTSIDE COVER IN SPECIAL  
SELF-LUBRICATING MATERIAL

**mm. 15x12**

MINARELLI-YAMAHA 50/100 cc.

GRAMMATURE DISPONIBILI  
WEIGHTS AVAILABLE

**gr. 4** ART. **8230-K4**

**gr. 4,5** ART. **8230-K4,5**



**gr. 5** ART. **8230-K5**

**gr. 5,5** ART. **8230-K5,5**

**gr. 6** ART. **8230-K6**



**gr. 6,5** ART. **8230-K6,5**



**gr. 8** ART. **8230-K8**



Grammature originali

#### APRILIA:

AMICO - GULLIVER 50	6,5
RALLY E RALLY H20 50	6,5
SONIC - SONIC H20 50	6,5
SCARABEO 50 2T	7
SCARABEO 100 2T	8
SR 50 - SR 50' 94 - SR DITECH H20	5,5
SR RACING - REPLICA LC - SR 50	5,5
SR STEALTH H20 50	5,5
SR WWW 50	6,5

#### BENELLI:

491 GT 50	6,5
491 50 SPORT H20 - K2 - K2 H20 50	7
NAKED - PEPE 50	7

#### BETA:

ARC ARIA E LIQUIDO - QUADRA 50	5,5
CHRONO 50	6,5
EIKON 50 H20 - TEMPO 50	7

#### ITALJET:

BAZOOKA - DRAGSTER 50 H20	6,5
MILLENNIUM 100	7,5
PISTA - PISTA 2 50	6,5
SCOOP 50 -REPORTER 50	6,5
TORPEDO 50 2T	6,5
YANKEE 50	6,5

#### LEM:

FLASH - TORNADO 50	6,5
--------------------	-----

#### MALAGUTI:

CENTRO 50 - CIACK 50	7
F10 - F12 H20	6,5
F12 PHANTOOM ARIA e H20	6,5
YESTERDAY 50	6,5

#### MBK:

ACTIVE - BOOSTER - NG - SPIRIT	6,5
FLIPPER	6,5
FORTE - OVETTO 50 - SORRISO	6,5
STUNT - TARGET	6,5
BOOSTER 100 - OVETTO 100	8
EVOLIS 50 - NITRO 100	7,5
FIZZ 50 - HOT CHAMP 50 -	7
ROCKET 50	7

#### YAMAHA:

AEROX 50 H20	5,5
AEROX 100	7,5
AXIS - BWS - CRZ - CT - JOG 50	7,5
NEOS 50	7,5
SLIDER 50 - WINE 50	6,5
BELUGA 50 - BREEZE 50 - SPY 50	7
BWS 100 - NEO'S 100	8
ZEST 50	7,5
ZUMA 50	7,5





## KIT RULLI DI CONTRASTO

ROLLERS SET



### HIGH PERFORMANCE

PARTE METALLICA IN OTTONE O ALLUMINIO  
RIVESTIMENTO ESTERNO IN  
MESCOLA SPECIALE AUTOLUBRIFICANTE

METALLIC PART IN BRASS OR ALUMINUM  
OUTSIDE COVER IN SPECIAL  
SELF-LUBRICATING MATERIAL

**mm. 16x13**

PIAGGIO 50 cc.

GRAMMATURE DISPONIBILI  
WEIGHTS AVAILABLE

**gr. 4,5** ART. **8210-K4,5**

**gr. 5,5** ART. **8210-K5,5**



**gr. 6,5** ART. **8210-K6,5**

**gr. 7** ART. **8210-K7**



**gr. 8** ART. **8210-K8**



Grammature  
originali

#### GILERA:

EASY MOVING 50 - STORM 50 8  
TYPHOON 50 - TYPHOON X 50 8

#### HONDA:

BALI 50 8  
BALI 100 9,5  
DIO CLEAN 4 YOU 4T 50 H20 6  
DIO G - DIO SP - DIO SRL 8  
DIO ZX '94 8  
LEAD 50 8  
SFX 8  
SGX SK5 50 5  
SH 50 '96 8  
SH 100 9,5  
SHADOOW 50 - SJ BALI 50 8  
SXR 50 8  
VISION 50 7,5  
VISION MEET IN - X9R - S50 8  
SC 01 - SC 01L 8

#### KYMCO:

AGILITY 50 R10/12/16 6,5  
DINK 50 4T 6,5  
HEROISM 50 - K12 - PEOPLE 50 8  
SNIPER 50 7,5  
SENTO 50 4T 6,5  
SUPER 8 50 4T 6,5  
SUPER 9 2T 50 H20 8  
TOP BOY - COBRA 50 8  
VITALITY 50 4T 6,5

#### PGO:

BIG MAX - COMET - STAR - STAR 2 8

#### PEUGEOT:

BUXI - BUXI RS 50 - ELYSEO 50 8  
GET FORCE TSD1 (HL1) 50 H20 7,5  
LOXOR TSDI 50 7,5  
METAL X 50 8  
RAPIDO 50 - METROPOLIS 50 8  
SPEEDFIGHT - SPEEDFIGHT 50 H20 8  
SQUAB 50 - SV GEO 50 8  
ST 50 7,5  
TREKKER 50 - VIVACITY KAT 50 8  
ZENITH 50 8

#### PIAGGIO:

FREE 50 8  
NRG LC 50 - NTT 50 8  
SFERA 50 - SFERA RESTYLING 50 8  
VESPA ET2 CARBURATORE 8  
VSPA ET4 50 4T 8  
ZIP 50 2T - ZIP FAST RIDER 50 8  
ZIP SP H20 FINO AL 2000 7  
QUARTZ H20 50 8



## KIT RULLI DI CONTRASTO

ROLLERS SET



### HIGH PERFORMANCE

PARTE METALLICA IN OTTONE O ALLUMINIO  
RIVESTIMENTO ESTERNO IN  
MESCOLA SPECIALE AUTOLUBRIFICANTE

METALLIC PART IN BRASS OR ALUMINUM  
OUTSIDE COVER IN SPECIAL  
SELF-LUBRICATING MATERIAL

**mm. 19x15,5**

GRAMMATURE DISPONIBILI  
WEIGHTS AVAILABLE

**gr. 5,3** ART. **8217-K5,3**



**gr. 6,5** ART. **8217-K6,5**



Grammature  
originali

#### APRILIA:

SR 2004 CARB. 50 CC. - H20 7,5  
SR DITECH GP1 50 H20 7,5

#### DERBI:

GP1 H20 - ATLANTIS BULLET 50 7,5

#### GILERA:

DNA 50 H20 7,5  
ICE 50 7,5  
RUNNER 50 H20 6,5  
RUNNER 50 PUREJET 6,5  
RUNNER SP 50 5,3  
RUNNER SP 50 H20 7,5  
STALKER 50 6,5  
TORPEDO NEW 2T 50 7,5

Grammature  
originali

#### ITALJET:

JET SET 50 7,5

#### PIAGGIO:

FREE 50 DAL 2001 7,5  
DIESIS 50 7,5  
NRG EXTREME - EXTREME H20 6,5  
LIBERTY 50 2T 6,5  
NRG MC2 50 H2O DAL '98 6,5  
NRG MC3 50 DD 7,5  
NRG MC3 50 DT 7,5  
NRG MC3 PUREJET 50 7,5  
VESPA ET2 INIEZIONE 50 6,5  
VESPA ET2 50 2000 7,5  
ZIP 50 2000 7,5  
ZIP SP 50 H2O DAL 2001 7,5

**mm. 19x17**

GRAMMATURE DISPONIBILI  
WEIGHTS AVAILABLE

**gr. 8,7** ART. **8215-K8,7**



Grammature  
originali

#### APRILIA:

SR 125- 150 12

#### DERBI:

BOULEVARD 125 4T 8,7  
BOULEVARD 150 4T 10

#### GILERA:

DNA 125 4T - RUNNER VXR 180 4T 10  
DNA 180 4T - RUNNER 125 '98 15,7  
RUNNER FX 125 12  
RUNNER VX 125 4T 7,5  
TYPHOON - TYPHOON X 125 12

#### ITALJET:

DRAGSTER 125 12  
DRAGSTER 125 '98 15,7  
JET SET 125 4T 8,7  
JET SET 150 4T 10

Grammature  
originali

#### PIAGGIO:

BEVERLY 125 4T 7,5  
HEXAGON 125 - 150 12  
HEXAGON LX 125 - LX4 125 4T 12  
LIBERTY 125 4T MOTORE LEADER 8,7  
LIBERTY 150 4T MOTORE LEADER 10  
SKIPPER 2T 125-150 - LX 125-150 12  
SKIPPER 125 4T MOTORE LEADER 8,7  
SKIPPER 150 4T MOTORE LEADER 10  
SUPER HEXAGON GTX 125 4T 7,5  
SUPER HEXAGON GTX 180 4T 12  
VESPA ET4 125 4T MOTORE LEADER 8,7  
VESPA ET4 150 4T MOTORE LEADER 10  
VESPA GTS 125 4T MOTORE LEADER 7,5  
X9 125 4T 8,7  
X9 180 AMALFI 4T 10  
ZIP 125 4T 8,7

#### RENAULT:

FULLTIME 125 4T 8,7





## KIT RULLI DI CONTRASTO

ROLLERS SET ROLLERS SET



### HIGH PERFORMANCE

PARTE METALLICA IN OTTONE O ALLUMINIO  
RIVESTIMENTO ESTERNO IN  
MESCOLA SPECIALE AUTOLUBRIFICANTE

METALLIC PART IN BRASS OR ALUMINUM  
OUTSIDE COVER IN SPECIAL  
SELF-LUBRICATING MATERIAL

**mm. 20x12**

GRAMMATURE DISPONIBILI  
WEIGHTS AVAILABLE

**gr. 14** ART. **8234-K14** (8 pz.)



	Grammature originali		Grammature originali
<b>APRILIA:</b>		<b>MBK:</b>	
LEONARDO 250 4T	14	DOODO 125 4T	9
<b>BENELLI:</b>		DOODO 150 4T	9,5
VELVET 125 4T	9	FLAME 125 4T	9
VELVET 150 4T	9,5	KILIBRE 300 4T	14
VELVET 250 4T	14	SKYLINER 125 4T	9
<b>ITALJET:</b>		SKYLINER 150 4T	9,5
JUPITER 125 4T	9	SKYLINER 250 4T	14
JUPITER 150 4T	9,5	THUNDER 125 4T	9
JUPITER 250 4T	14	THUNDER 150 4T	9,5
MILLENNIUM 125 4T	9	<b>YAMAHA:</b>	
MILLENNIUM 150 4T	9,5	CYGNUS 125 4T	9
TORPEDO 125 4T	9	MAJESTY 125 4T	9
TORPEDO 125-150 4T mot.LEADER	9,5	MAJESTY 150 4T	9,5
<b>MALAGUTI:</b>		MAJESTY 250 4T	14
F12 PHANTOOM MAX 125 4T mot.Yamaha	9	MAXTER 125 4T	9
F18 WARIO 125-150	9	MAXTER 150 4T	9,5
MADISON 125-150 4T	9	TEO'S 125 4T	9
MADISON 250 4T	14	TEO'S 150 4T	9,5
		VERSITY 300 4T	14

**mm. 20x15**

GRAMMATURE DISPONIBILI  
WEIGHTS AVAILABLE

**gr. 12** ART. **8235**



	Grammature originali		Grammature originali
<b>BETA:</b>		<b>LAVERDA:</b>	
EIKON 125 - 150	14,5	PHOENIX 125 - 150 4T	13,5
<b>HONDA</b>		<b>LINHAI:</b>	
@ NES 125 4T - 150 4T	12	MONARCH 125 - 150 4T	14,5
DYLAN 125 4T - 150 4T	12	<b>SUZUKI:</b>	
PHANTEON 125 4T INIEZIONE	12	BURGMAN HU 125-150 4T	13
PHANTEON 150 4T INIEZIONE	13,5	EPICURO 125	10,5
SH 125 4T - 150 4T	12	EPICURO 150 4T	13
<b>KYMCO:</b>		<b>SYM:</b>	
BET & WIN 125 4T - 150 4T	14,5	EURO MX 125 4T	12
DINK 125	12	SUPER DUKE 150	14,5
DINK 98 125	13,5		
GRAND DINK 125 4T	12		
GRAND DINK 125 4T - 150 4T	14,5		
PEOPLE 125 4T - 150 4T	14,5		
VIVIO 125 4T - 150 4T	14,5		

## GIRANTI FRIZIONE CLUTCH ASSY

MOTORI PIAGGIO - MINARELLI 50 cc.

PER CAMPANE / FOR CLUTCH DRUM **DIAMETRO mm. 107**

### PIAGGIO

FREE 100 ('02-'03) - LIBERTY 50 ('97-'05) - LIBERTY PTT EU2 50 ('04-'05) - NRG 50 ('94-'96) - NTT 50 ('95-'96) - QUARTZ 50 ('92-'96)  
 SFERA MAQUILLAGE 2 50 ('94) - SFERA RST 50 ('95-'97) - VESPA ET2 50 ('97-'05) - VESPA ET2 INIEZIONE 50 ('97-'00)  
 VESPA LX 2T 50 ('05-'13) - VESPA LX 2T TOURING & 30 KM. 50 ('10-'13) - VESPA LXV 2T 50 ('06-'09) - VESPA LXV 2T NAVY 50 ('08)  
 VESPA S 2T & COLLEGE 50 ('07-'12) - ZIP 50 ('95-'04) - ZIP 4T 50 ('00-'05) - ZIP BIMODALE 50 ('94-'97) - ZIP FAST RAIDER 50 ('93-'94)  
 ZIP FAST RAIDER RST 50 ('96-'97) - ZIP RST 50 ('96-'99)

### GILERA

EASY MOVING 50 ('95-'96) - STORM 50 ('94-'95) - TYPHOON 50 ('94-'97) - TYPHOON X 50 ('98-'99)

### APRILIA

SCARABEO 4T 100 ('10-'14) - SCARABEO RST 4T 100 ('06-'09) - SCARABEO NET 4T 100 ('09) - SCARABEO NET EU3 4T 100 ('10)

### HONDA

VISION - DIO - GP - SC - HSC - BALI

### PEUGEOT

SV - BUXI - SQUAB - XENITH - SPEEDAKE - GEO

### MALAGUTI

F 15 FIRE FOX



**Gr. 610**

ART. **10315-E**

GIRANTE FRIZIONE VERSIONE **ORIGINALE "ECO"**

(Sim. CM1002015-289937)



**Gr. 470**

ART. **10315-ALE**

GIRANTE FRIZIONE **"ECO-RACING" ALLEGGERITA**

con molle speciali pre-carico Kg.12  
 with special springs pre-load Kg. 12





## GIRANTI FRIZIONE CLUTCH ASSY

MOTORI MINARELLI - YAMAHA 50 cc.

PER CAMPANE / FOR CLUTCH DRUM **DIAMETRO mm. 105**

**MBK**  
BOOSTER .....

**APRILIA**  
AMICO - SR.....

**YAMAHA**  
CT 50 .....

**MALAGUTI**  
F 10 - F 12 PHANTOOM.....

**ITALJET**  
BAZOOKA - REPORTER - PISTA 1-2..



**Gr. 610**

ART. **10314-E**

GIRANTE FRIZIONE VERSIONE ORIGINALE "ECO"



**Gr. 470**

ART. **10314-ALE**

GIRANTE FRIZIONE "**ECO-RACING**" **ALLEGGERITA**

con molle speciali pre-carico Kg.12  
with special springs pre-load Kg. 12

## CAMPANE FRIZIONE

### CLUTCH DRUMS



ART. **8244**

CAMPANA FRIZIONE / CLUTCH DRUM

**Ø INTERNO / INTERNAL mm. 105**  
**ALTEZZA / HEIGHT mm.34**

ADATTABILE A / SUITABLE TO: **MOTORI MINARELLI - YAMAHA 50 cc.**

SCOOTER  
**APRILIA - BETA - ITALJET - MALAGUTI - MBK**



ART. **8245**

CAMPANA FRIZIONE / CLUTCH DRUM

**Ø INTERNO / INTERNAL mm. 107**  
**ALTEZZA / HEIGHT mm.34**

ADATTABILE A / SUITABLE TO: **MOTORI MINARELLI 50 cc.**

**MALAGUTI F 15 FIRE FOX**



ART. **8248**

CAMPANA FRIZIONE / CLUTCH DRUM

(Sim. 289933)

**Ø INTERNO / INTERNAL mm. 107**  
**ALTEZZA / HEIGHT mm.34**

ADATTABILE A / SUITABLE TO:

#### PIAGGIO

DISIS 50 ('01)-FLY 2T 50('05-'07) - 4T 50('08) - 4T MOTORE CHIN 50('06-'07) - 4T 100('06-'08)  
FREE 50 ('92-'94) - DELIVERY 50 ('00-'01) - FL 50('95-'02) - LIBERTY 50 ('97-'05) - 2T 50 ('06-'08)  
LIBERTY 4T 50 ('00-'08) - 2T/4T RST 50 ('04) - PTT EU2 50('04-'05) - SPORT 2T/4T 50 ('06-'08)  
NRG EXTREME 50 (99-'00) - MC2 50(96-'98) - MC3 50(01-'04) - DT 50 (06-'08) -POWER DD 50(05-'08)  
NRG POWER PUREJET 50 ('04-'08) - PUREJET 50('02-'04) - NTT 50 ('95-'96) - QUARTZ 50 ('92-'96)  
SFERA MAQUILLAGE2 50 ('94) - SFERA RST 50 (95-'97) - VESPA ET2 50(97-'05)-ET2 INIEZ.50(97-'00)  
VESPA ET4 50 ('00-'05) - VESPA LX 2T/4T 50('05-'08) - LXV 2T 50 ('06-'08) - LXV 2T NAVY 50('08)  
VESPA S 2T 50('07-'08) -ZIP 50 ('95-'96) - ZIP FAST RAIDER 50 ('93-'94) - ZIP RST ('96-'97)  
ZIP 4T 50 ('00-'08) - ZIP 4T 100 ('06-'08) - ZIP SP 50 ('01-'04) - ZIP SP EU2 50 ('06-'08)

#### GILERA

DNA 50 ('00-'02) - 50 ('05-'07) - GP EXPERIENCE 50 ('03-'04) - ICE 50 ('01-'05)  
RUNNER 50 ('97-'00) - POGGIALI 50 ('02) - PUREJET 50 ('02-'07) - SP 50 ('02-'07)  
RUNNER SP EDIZIONE SPECIALE 50 ('07) - RUNNER SP ST 50 ('08)  
STALKER 50 (97-'08) - EDIZ.SPEC.50 (07-'08) - NAKED 50(08)  
STORM 50(94-'95)- STORM EU2 50(07)  
TYPHOON 50('94-'97)-X 50('98-'99)-XR 50 ('00)

#### HONDA VISION

**PEUGEOT BUXI - GEO .....**





## CAMPANE FRIZIONI CLUTCH DRUMS



ART. **8240-E**

RUOTA LIBERA / FREE WHEEL

ADATTABILE A / SUITABLE TO: MOTORI MINARELLI 50 cc.  
APRILIA MALAGUTI YAMAHA

(RIF.MAL. 726.017.00 - MIN. 26.000.70)

**125/180 cc.**

**Ø INTERNO / INTERNAL mm. 134**  
**ALTEZZA / HEIGHT mm. 42**



ART. **8250**

CAMPANA FRIZIONE  
CLUTCH DRUM

(Sim. 82502R-478735 - AP.8550109)

**125** **APRILIA**  
SR 125 ('99-'01)

**125** **GILERA**  
RUNNER FX 125 ('97-'02)  
TYPHOON 125 ('95-'98) - XR 125 ('99-'00)

**180** RUNNER FXR 180 ('97-'02)

**180** **ITALJET**  
DRAGSTER 180 ('99-'03)

**125** **PIAGGIO**  
HEXAGON 125 ('94-'97) - LX 125 ('98-'99)  
SKIPPER 125 ('94-'97) - LX 125 ('98-'99)

**180** HEXAGON LXT 180 ('98-'99)

## CAMPANE FRIZIONE

### CLUTCH DRUMS

**125/150/180 cc.**  
**200/250/300 cc.**

**Ø INTERNO / INTERNAL mm. 134**  
**ALTEZZA / HEIGHT mm. 52**



ART. **8263**

CAMPANA FRIZIONE

(Sim. 84404945)

#### APRILIA

**125** ATLANTIC EU3 125 (06-08)-EU3 125 (10-11)  
MOJITO 125 (03-08) - SCARABEO LIGHT 125 (07-08) - SPORT CITY 125 (04-06)  
SPORT CITY CUBE 125 (08-10) - EU3 125 (06-08) - ONE 4T EU3 125 (08-10)  
SR MAX 125 (08-11)

**250** ATLANTIC EU3 250 (06-08) - SCARABEO LIGHT 250 (06-08)  
SPORT CITY CUBE 250 (08-10) - EU3 250 (06-08)

**300** SCARABEO LIGHT 300 (09-10) - SPORT CITY STREET 300 (12)

#### DERBI

**125** BOULEVARD EU3 125 (04-07) - 4T EU3 125 (08)  
GP1 EU2 125 (06) - RAMBLA 125 (08)

**150** BOULEVARD EU3 150 (04-07) - RAMBLA 150 (08)

**200** BOULEVARD 200 (05)

**250** RAMBLA 250 (08)

#### GILERA

**125** NEXUS EU3 125 (07-08) - EU3 IE 125 (08-10) - RUNNER 4T ST EU3 125 (08-16)  
RUNNER VX 125 (05-06) - VX 4T EU3 125 (06-07) - VX SC 125 (06-07)  
RUNNER VX RACE 125 (06-06) - TYPHOON 4T 2V EU3 125 (10-11)

**180** DNA 180 (01) - RUNNER VXR 180 (00-01)

**200** RUNNER VXR 200 (05-06) - VXR 4T ST EU3 200 (08-11) - VXR EU3 200 (2007)  
RUNNER VXR RACE 200 (05-06)

**250** NEXUS EU3 250 (06-07) - NEXUS SP EU3 250 (06-07) - OREGON 250 (06-10)

**300** NEXUS EU3 300 (08-11)

#### PIAGGIO

**125** BEVERLY EU3 125 (07-08) - EU3 MIC 125 (2007) - EU3 SPORT 125 (07-08)  
BEV.RST 125 (05-07) - RST 4T 4V IE EU3 125 (10-15) - TOURER EU3 125 (07-10)  
CARNABY 125 (07-10) - FLY 125 (05-07) - EU3 125 (07-11) - HEXAGON GTX 125 (00)  
LIBERTY 125 (01-02) - 4T 125 (06-07) - 4T EU3 125 (06-08) - 4T 2V EU3 125 (09-12)  
4T EU3 DELIVERY-SINGLE 125 (07-15) - 4T EU3 DELIV. - TNT-NEXIVE 125 (08-15)  
4T SPORT EU3 125 (06-08) - RST PTT 125 (05-11) - SPORT 125 (06) - MP3 125 (06-08)  
MPE IE 125 (08-11) - IE TOURING 125 (11-12) - YOURBAN ERL 125 (11-13)  
SKIPPER 4T 125 (00-02) - SUPER HEXAGON GTX 12" 125 (01-02)  
VESPA ET4 125 (99-02) - LX 125 (05-06) - LX 4T EU3 TOURING 125 (10-11)  
VESPA LX 4T FL 125 (09) - LX EU3 125 (06-08) - LX EU3 IE 125 (09-11) - LXV 4T EU3  
125 (06-09) - LXV 4T NAVY EU3 125 (07-08) - GRANTURISMO EU3 125 (06-07) - GTS  
4T IE SUPER 125 (09-16) - GTS EU3 125 (07-12) - GTV 125 (06-08) - GTV 4T NAVY  
EU3 125 (2008) - VESPA S 4T EU3 125 (07-08) - S 4T IE & COLLEGE 125 (09-11)  
X EVO 125 (07-16) - X7 EU3 125 (2008) - X7 EVO IE EU3 125 (09-10) - X8 125 (05-06)  
PREMIUM EU2 125 (06) - X8 PREM. EU3 125 (06-07) - X8 STREET EU2 125 (06-07)  
X9 EVOLUTION 125 (05-06) - X9 EVOL. EU3 125 (2007)  
X10 4T 4V IE EU3 125 (12-15) - ZIP 125 (00-02)

**150** FLY 150 (05-07) - EU3 150 (08-11) - LIBERTY 4T EU3 150 (08) - 4T SPORT EU3 150 (08)  
LIB.MOC 4T EU3 150 (09-13) - VESPA LX 150 (05-06) - LX 4T FL 150 (2009)  
VESPA LX EU3 150 (06-08) - LX EU3 IE 150 (09-11) - LX TOURING 150 (10-12)  
VESPA S 4T 150 (08-09) - VESPA S 4T IE & COLLEGE 150 (09-12)  
X8 STREET EU2 150 (06-08)

**180** HEXAGON GTX 180 (00) - SUPER HEXAGON GTX 12" 180 (01-02)

**200** CARNABY 200 (07-08) - LIBERTY 200 (2006) - 4T EU3 200 (06-08) - RST 200 (04)  
LIBERTY 4T SPORT EU3 200 (06-07) - SPORT 200 (2006) - X8 200 (05-07)

**250** BEVERLY 250 (05-07) - CRUISER 250 (07-09) - EU3 MIC 250 (2007) - IE EU3 250 (06-08)  
BEV.RST 250 (04-05) - SPORT 250 (06-08) - TOURER EU3 250 (07-09)  
CARNABY 250 (08-09) - MP3 250 (06-08) - MIC 250 (08-09) - MP3 LT 250 (08-09)  
VESPA GT 60 EURO 3 250 (06-07) - GTS 250 (05-14) - GTS ABS 250 (05-12)  
VESPA GTV 250 (06-09) - GTV 4T NAVY EU3 250 (2007) - X EVO 250 (07-13)  
X7 EU3 250 (2008) - X8 EU3 250 (05-08) - X9 EVOLUTION 250 (2008)

**300** BEVERLY IE ABS E4 (EMEA) 300 (16-19) - RST 4T 4V IE EU3 300 (10-16)  
BEVERLY TOURER EU3 300 (09-10) - CARNABY CRUISER 300 (09-12)  
MP3 300 IE MIC 300 (2011) - 300 LT BUSINESS-SPORT ABS-ENJOY 300 (14-16)  
MP3 300 IE LT 300 (10-11) - 300 IE MIC 300 (2010) - IE LT TOURING 300 (11-13)  
MP3 IE LT-IE LT SPORT 300 (11-14) - IE TOURING 300 (11-12)  
MP3 IE E4 LT BUSINESS-SPORT ABS 300 (16-18) - YOURBAN ERL 300 (11-15)  
MP3 YOURBAN LT ERL 300 (11-16) - MP3 YOURBAN LT RL E4 300 (17-18)  
VESPA GTS-GTS SUPER IE ABS E4 (EMEA) 300 (16-18)  
GTS IE & TOURING 300 (11-16) - GTS SUPER 300 (08-16)  
GTS SUPER SPORT 300 (10-13) - GTV 4T 4V IE 300 (10-13)  
GTV VIA MONTENAPOLEONE 300 (2010)  
GTV SEI GIORNI IE E4 ABS (EMEA) 300 (2017) - X7 EVO IE EU3 300 (09-10)

GIRANTI FRIZIONE ADATTABILI  
CLUTCH ASSY SUITABLE



CIF ART. **17614**



CIF ART. **17636**





## GIRANTI FRIZIONE

### CLUTCH ASSY

125/180 cc



ART. **17612**

GIRANTE FRIZIONE gr. 970

(Sim. KY.127761-MAL53500200)

**125 HONDA**  
CHIOCCIOLA 125('00-'06) - DYLAN 125('01-'06) - NES 125 ('00-'07)  
SH 125 ('01-'08) - 125I 125 ('01-'08)

**150** CHIOCCIOLA 150('00-'06) - DYLAN 150('01-'06) - NES 150 ('00-'07)  
SH 150 ('01-'08) - SH 150I 150 ('01-'08)

**125 KYMCO**  
AGILITY 125 4T ('06)-RST 125 ('09) - HEROISM 125 ('95-'97)  
MOVIE 125 ('99-'00)- EU3 125 ('06-'07)  
MOVIE XI 125 ('01)-XI EU2 125 ('03-'04) - PEOPLE 125 ('99-'00)  
PEOPLE EU2 125 ('03)-EU3 125 ('07-'08) - VIVIO 125 ('00)

**150** MOVIE 150 EU3 ('06-'07) - XI 150('01) - XI EU2 150 ('03-'04)  
PEOPLE 150 ('99-'00) - EU2 150 ('03) - VIVIO 150 ('00)

**125 MALAGUTI**  
CIAK 125 ('00-'01) - RST EU2 125 ('03) - MASTER 125 ('04)

**150** CIAK 150 ('00-'01) - RST EU2 150 ('03) - MASTER 150 ('04)

**125 SYM**  
JOYRIDE EU2 125 ('05-'06) - EU3 125 ('07) - EVO 125 ('09)



ART. **17613-K**

KIT GIRANTE+CAMPANA FRIZIONE  
CLUTCH ASSY+DRUM, SET

**125 HONDA**  
SH 125 - CHIOCCIOLA @ 125 - DYLAN 125 - PHANTEON 4T125

**150** SH 150 - CHIOCCIOLA @ 150 - DYLAN 150 - PHANTEON 4T150

**125 KIMCO**  
HEROISM 125 ('95-'97) - MOVIE 125 ('99-'00) - XI 125  
PEOPLE 125 ('99-'00) - EU2 125 ('03) - VIVIO 125 ('00)

**150** HEROISM 150 - MOVIE 150 ('01) - XI EU2 150 ('03)  
PEOPLE 150 ('99-'00) - EU2 150 ('03) - VIVIO 150 ('00)

**125 MALAGUTI**  
CIAK 125 ('00-'02) - RST EU2 125 ('03) - MASTER 125 ('04)

**150** CIAK 150 ('00-'02) - RST EU2 150 ('03) - MASTER 150 ('04)

## GIRANTI FRIZIONE

### CLUTCH ASSY

#### 125/180 cc.



ART. **17614**

GIRANTE FRIZIONE gr. 1120

(Sim.CM144005)



CAMPANA FRIZIONE ADATTABILE  
CLUTCH DRUM SUITABLE  
CIF ART. **8263**

#### APRILIA

**125** ATLANTIC EU3 125 (06-08) - EU3 125 (10-11)  
MOJITO 125 (03-08) - SCARABEO LIGHT 125 (07-08)  
SPORT CITY 125 (04-06) - SPORT CITY CUBE 125 (08-10)  
SPORT CITY EU3 125 (06-08) - ONE 4T EU3 125 (08-10)  
SR MAX 125 (08-11)

#### DERBI

**125** BOULEVARD EU3 125 (04-07) - 4T EU3 125 (08)  
GP1 EU2 125 (06) - RAMBLA 125 (08)

**150** BOULEVARD EU3 150 (04-07) - RAMBLA 150 (08)

#### GILERA

**125** NEXUS EU3 125 (07-08) - EU3 IE 125 (08-10)  
RUNNER VX 125 (05-06) - VX 4T EU3 125 (06-07)  
VX RACE 125 - VX SC 125 (06-07) - VX 4T ST EU3 125 (08-12)

#### PIAGGIO

**125** BEVERLY RST 125 (04-07) - EU3 125 (07-08) - EU3 MIC 125 (07)  
EU3 SPORT 125 (07-08) - RST 4T 4V IE EU3 (10-12) - TOURER EU3  
125 (08-10) - CARNABY 125 (07-10)  
HEXAGON GTX 125 (00) - LIBERTY 125 (01-02) - RST 125 (04-05)  
MP3 125 (07-08) - IBRIDO 125 (09-10) - IE 125 (08-09)  
SKIPPER 4T 125 (00-02) - SUPER HEXAGON GTX 125 (01-02)  
VESPA ET4 125 (99-02) - VESPA GRANTURISMO 125 (03-07) - EU3  
125 (06-07) - VESPA GTS EU3 125 (07-11) - 4T NAVY EU3 125 (08)  
GTS 4T IE SUPER 125 (09-12) - X EVO 125 (07-12) - X7 EU3 125 (08)  
X8 125 (05-06) - PREMIUM EU2 (06) - EU3 125 (06-07)  
X9 125 (01-02) - EVOLUTION 125 (05-06) - EVOL. EU3 125 (07)  
ZIP 125 (00-02)

**150** VESPA LX EU3 IE 150 (09-11)

#### 200 cc.



ART. **17624**

GIRANTE FRIZIONE gr. 1160

**MOLLE / SPRINGS 7 SPIRE**

(Sim.CM1440075 - AP.8575014)



CAMPANA FRIZIONE ADATTABILE  
CLUTCH DRUM SUITABLE  
CIF ART. **8263**

#### APRILIA

**200** ATLANTIC 200 (03-05)  
SCARABEO 200 (03) - EU3 200 (06-07)  
SPORT CITY 200 (04-06) - SPORT CITY EU3 200 (06-08)  
SPORT CITY CUBE 200 (08-10)

#### GILERA

**200** RUNNER VXR 200 (05-06) - VXR EU3 200 (07)  
VXR RACE 200 (06) - VXR 4T ST EU3 200 (08)

#### PIAGGIO

**200** VESPA GRANTURISMO 200 (06-07)  
BEVERLY 200 (01-03)  
CARNABY 200 (07-08)  
X8 200 (05-07)





## GIRANTI FRIZIONE

CLUTCH ASSY

250/300 cc.



ART. **17632**

GIRANTE FRIZIONE gr. 1300

**250**

**APRILIA**

LEONARDO 250 ('99-'01) - ST 250 ('01->)

**250**

**MALAGUTI**

MADISON S 250 ('99-'01)

**250**

**MBK**

YP SKYLINER 250 (->'00)

**250**

**YAMAHA**

YP MAJESTY 250 ('96-'98) - YP MAJESTY DX 250 ('98-'00)



ART. **17634**

GIRANTE FRIZIONE gr. 1350

(Sim.5GM166200100)

**250**

**MBK**

YP SKYLINER 250 ('00-'03)- YP SKYLINER ABS 250 ('03)

**300**

XC KILIBRE 300 ('03)

**250**

**YAMAHA**

CITY 250 ('07-'10)  
MAX 250 ('06-'10) - MAX 250 ('09)  
YP R X 250 - YP R BLACK X 250 - VPX 250

**300**

XC VERSITY 300 ('03-'06)



ART. **17638**

GIRANTE FRIZIONE gr. 1330

Sim.496302 -Peug.754982)

**250**

**HONDA**

FORESIGHT 250 ('98-'00)

**300**

SH 300I 300 ('07-'08)

**250**

**PEUGEOT**

SV 250 ('01-'02)

**250**

**PIAGGIO**

X9 250 ('00-'01)

## GIRANTI FRIZIONE

### CLUTCH ASSY

250/300 cc



ART. **17636**

GIRANTE FRIZIONE gr. 1170

**MOLLE / SPRINGS 8 SPIRE**

(Sim.CM1440175 - AP.8722515)



CAMPANA FRIZIONE ADATTABILE  
CLUTCH DRUM SUITABLE  
CIF ART. **8263**

**APRILIA**  
**250** ATLANTIC EU3 250 ('06-'08)  
SCARABEO LIGHT 250 ('06-'08)  
SPORT CITY CUBE 250 ('08-'10)  
SPORT CITY CUBE EU3 250 ('06-'08)

**300** SCARABEO LIGHT 300 ('09-'10)  
SPORT CITY STREET 300 ('12)

**DERBI**  
**250** RAMBLA 250 ('08)

**GILERA**  
**250** NEXUS EU3 250 ('07)

**PIAGGIO**  
**250** VESPA GTV 4T NAVY EU3 250 ('08)  
BEVERLY CRUISER 250 ('07-'09)-BEVERLY IE EU3 250 ('06-'08)  
BEVERLY RST 250 ('04-'05) - BEVERLY TOURER EU3 250 ('08-'09)  
CARNABY 250 ('08)  
MP3 LT 250 ('09) - MP3 MIC 250 ('08-'09)  
X EVO 250 ('07-'11)-X9 EVOLUTION 250 ('06)

**300** VESPA GTS IE 300('12)-IE TOURING 300 ('11)  
VESPA GTS SUPER 300('08-'11) - SUPER SPORT 300 ('10-'12)  
VESPA GTV 4T 4V IE 300 ('10-'12)  
BEVERLY RST 4T 4V IE EU3 300 ('10-'12)  
BEVERLY TOURER EU3 300 ('09-'10)  
CARNABY CRUISER 300 ('09-'11)  
MP3 IE LT 300 ('10-'11) - MP3 IE MIC 300 ('10-'11)  
MP3 IE LT TOURING 300- IE LT SPORT ('11-'12)  
MP3 YOURBAN ERL 300 ('11) - YOURBAN LT ERL 300 ('11-'12)  
X7 EVO IE EU3 300 ('09-'10)



ART. **17637-K**

KIT GIRANTE+CAMPANA FRIZIONE  
CLUTCH ASSY+DRUM, SET

**APRILIA**  
**250** ATLANTIC EU3 250 ('06-'08)  
SCARABEO LIGHT 250 ('06-'08)  
SPORT CITY CUBE 250 ('08-'10) - EU3 250 ('06-'08)

**300** SCARABEO LIGHT 300 ('09-'10)-SPORT CITY STREET 300 ('12)

**DERBI**  
**250** RAMBLA 250 ('08)

**GILERA**  
**250** NEXUS EU3 250 ('07)

**PIAGGIO**  
**250** VESPA GTV 4T NAVY EU3 250 ('08)  
BEVERLY CRUISER 250 ('07-'09)-IE EU3 250 ('06-'08)  
BEVERLY RST 250 ('04-'05) - TOURER EU3 250 ('08-'09)  
CARNABY 250 ('08)  
MP3 LT 250 ('09) - MP3 MIC 250 ('08-'09)  
X EVO 250 ('07-'11)-X9 EVOLUTION 250 ('06)

**300** VESPA GTS IE 300('12)- GTS IE TOURING 300 ('11)  
GTS SUPER 300('08-'11) - GTS SUPER SPORT 300 ('10-'12)  
VESPA GTV 4T 4V IE 300 ('10-'12)  
BEVERLY RST 4T 4V IE EU3 300 ('10-'12)-TOURER EU3 300 ('09-'10)  
CARNABY CRUISER 300 ('09-'11)  
MP3 IE LT 300 ('10-'11) - MP3 IE MIC 300 ('10-'11)  
MP3 IE LT TOURING 300-MP3 IE LT SPORT ('11-'12)  
MP3 YOURBAN ERL 300 ('11) - YOURBAN LT ERL 300 ('11-'12)  
X7 EVO IE EU3 300 ('09-'10)





## GIRANTI FRIZIONE

CLUTCH ASSY

400/500 cc.



ART. **17640**

GIRANTE FRIZIONE gr. 1750

(Sim.2150115F01000)

400

### SUZUKI

AN BURGMAN K3/K6 400 ('03-'06)  
BURGMAN X/K2 400 ('99-'02)



ART. **17650**

GIRANTE FRIZIONE gr. 1860

**MOLLE / SPRINGS 8 SPIRE**

(Sim.8405775)

400

### APRILIA

SCARABEO LIGHT 400 ('06-'08)

500

ATLANTIC SPRINT 500 ('05-'08)  
SCARABEO LIGHT 500 ('06-'08)

400

### GILERA

NEXUS EU3 500 ('06-'09)

400

### PIAGGIO

BEVERLY EU3 400 ('06-'07)  
BEVERLY TOURER EU3 400 ('08-'10)  
MP3 400 ('07-'08)-IE LT -  
MP3 IE LT SPORT 400 ('08-'10)  
MP3 LT/RL TOURING 400 ('11)  
X EVO 400 ('07-'09)  
X8 EU3 400 ('06-'07)

500

BEVERLY 500 ('02-'06)  
BEVERLY EU3 500 ('06-'08)  
CRUISER 500 ('07-'11)  
X9 EVOLUTION 500 ('06-'07)  
X9 EVOLUTION ABS 500 ('06-'07)

## KIT REVISIONA ASSE RUOTA POST. REAR WHEEL AXLE REVISION KIT

### PIAGGIO

LIBERTY 50 ('97-'05)  
NRG RST MC2 50 ('96-'98)  
ZIP FAST RIDER RST 50 ('96-'97)  
ZIP FRENO A DISCO  
ZIP RST 50 ('96-'99)  
ZIP S.P.50 ('96-'00)  
VESPA ET2 50 ('97-'05)  
VESPA ET2 INIEZIONE 50 ('97-'00)

### GILERA

RUNNER 50 ('97-'00)  
RUNNER doppio disco / double disc  
STALKER - STALKER / double disc



- Lunghezza Asse mm. 146
- Estremità lato astuccio Ø mm. 12



ART. **6500**

COMPLESSIVO SCATOLATO

Composto da / composed of:

CIF ART.	Rif.OEM	Descrizione / Description
	480053	Asse ruota / wheel axle <b>lunghezza / lenght mm.146</b>
6623	194424	Dado fissa ruota/ nut sec.wheel
6622	194423	Scodellino di sicurezza / cap sec.nut
6627		Coppiglia / split pin



ART. **6500-KT**

KIT COMPLETO / COMPLETE KIT

KIT Composto da / Kit composed of:

CIF ART.	Rif.OEM	Descrizione / Description
	480053	Asse ruota / wheel axle <b>lunghezza / lenght mm.146</b>
6623	194424	Dado fissa ruota/ nut sec.wheel
6622	194423	Scodellino di sicurezza / cap sec.nut
6627		Coppiglia / split pin
5950	478498	Paraolio / oil seal (30x47x6)
5838-A	130491	Astuccio a rulli aperto / open roller cage (12x18x12)
16204-2RS	434735	Cuscinetto asse ruota / wheel axle bearing (20x47x14)





## KIT REVISIONE ASSE RUOTA POST. REAR WHEEL AXLE REVISION KIT



- Lunghezza Asse mm. 126
- Estremità lato astuccio Ø mm. 12

### PIAGGIO

FREE 50 ('92-'94)  
 FREE FL 50 ('95-'02)  
 NRG 50('94-'96)  
 NRG RST MC2 50 ('96-'98)  
 NTT 50 ('95-'96) -  
 QUARTZ 50 ('92-'96)  
 SKR CITY 80 ('99)  
 SFERA 50 ('91-'93)  
 SFERA MAQUILLAGE2 50 ('94)  
 SFERA RST 50 ('95-'97)  
 ZIP 50 ('92-'96)  
 ZIP BIMODALE 50 ('94-'97)  
 ZIP FAST RAIDER 50 ('93-'94)

### GILERA

EASY MOVING 50 ('95-'96)  
 STORM 50 ('94-'95)  
 TYPHOON 50 ('94-'97)



ART. **6502**

COMPLESSIVO SCATOLATO

Composto da / composed of:

CIF ART.	Rif.OEM	Descrizione / Description
	478155	Asse ruota / wheel axle <b>lunghezza / lenght mm.126</b>
6623	194424	Dado fissa ruota/ nut sec.wheel
6622	194423	Scodellino di sicurezza / cap sec.nut
6627		Coppiglia / split pin



ART. **6502-KT**

KIT COMPLETO / COMPLETE KIT

KIT Composto da / Kit composed of:

CIF ART.	Rif.OEM	Descrizione / Description
	478155	Asse ruota / wheel axle <b>lunghezza / lenght mm.126</b>
6623	194424	Dado fissa ruota/ nut sec.wheel
6622	194423	Scodellino di sicurezza / cap sec.nut
6627		Coppiglia / split pin
5950	478498	Paraolio / oil seal (30x47x6)
5838-A	130491	Astuccio a rulli aperto / open roller cage (12x18x12)
16204-2RS	434735	Cuscinetto asse ruota / wheel axle bearing (20x47x14)



## KIT REVISIONA ASSE RUOTA POST. REAR WHEEL AXLE REVISION KIT

### PIAGGIO

VESPA ET4  
SFERA 125 RST 4T  
HEXAGON 125-150  
SKIPPER 125 -150

### GILERA

TYPHOON 125  
TYPHOON X-XR 125



- Lunghezza Asse mm. 143
- Estremità lato astuccio Ø mm. 15



ART. **6501**

COMPLESSIVO SCATOLATO

Composto da / composed of:

CIF ART.	Rif.OEM	Descrizione / Description
	478156	Asse ruota / wheel axle <b>lunghezza / lenght mm.143</b>
6623	194424	Dado fissa ruota/ nut sec.wheel
6622	194423	Scodellino di sicurezza / cap sec.nut
6627		Coppiglia / split pin

ART. **6501-KT**

KIT COMPLETO / COMPLETE KIT

KIT Composto da / Kit composed of:

CIF ART.	Rif.OEM	Descrizione / Description
	478156	Asse ruota / wheel axle <b>lunghezza / lenght mm.143</b>
6623	194424	Dado fissa ruota/ nut sec.wheel
6622	194423	Scodellino di sicurezza / cap sec.nut
6627		Coppiglia / split pin
5950	478498	Paraolio / oil seal (30x47x6)
5838-A	130491	Astuccio a rulli aperto / open roller cage (12x18x12)
16204-2RS	434735	Cuscinetto asse ruota / wheel axle bearing (20x47x14)







## KIT REVISIONE ASSE RUOTA POST.

REAR WHEEL AXLE REVISION KIT



ART. **16195-KRP**

KIT REVISIONE ASSE RUOTA POSTERIORE

**PIAGGIO** NRG - LIBERTY - ZIP - VESPA ET4 - HEXAGON

**GILERA** TYPHOON - RUNNER

**KIT Composto da / Kit composed of:**

CIF ART.	Pz/Pcs	Misura / Size	Descrizione / Description
16204-2RS	1	20x47x14 (SKF 6204-2RSH)	Cuscinetto / bearing
5950	1	30x47x6 (Corteco)	Paraolio



ART. **16194-KRP**

KIT REVISIONE ASSE RUOTA POSTERIORE

motori **MINARELLI-YAMAHA**

**MBK** BOOSTER

**KIT Composto da / Kit composed of:**

CIF ART.	Pz/Pcs	Misura / Size	Descrizione / Description
16210	1	17x40x12 (SKF 6203-2RSH)	Cuscinetto / bearing
5923	1	22x32x6RP (Corteco)	Paraolio

## RICAMBI ASSE RUOTA POST. REAR WHEEL AXLE SPARE PARTS

### PIAGGIO

FREE 50 ('92-'94)  
FREE FL 50 ('95-'02)  
NRG 50 ('94-'96)  
NRG RST MC2 50 ('96-'98)  
NTT 50 ('95-'96)  
QUARTZ 50 ('92-'96)  
SFERA 50 ('91-'93)  
SFERA MAQUILLAGE2 50 ('94)  
SFERA RST 50 ('95-'97)  
SKR CITY 80 ('99)  
ZIP 50 ('92-'96)  
ZIP BIMODALE 50 ('94-'97)  
ZIP FAST RAIDER 50 ('93-'94)  
FAST RAIDER RST 50 ('96-'97)

### GILERA

EASY MOVING 50 ('95-'96)  
STORM 50 ('94-'95)  
TYPHOON 50 ('94-'97)  
TYPHOON X 50 ('98-'99)



ART. **10057**

COPERCHIO ASSE RUOTA POSTERIORE  
COMPLETO DI CUSCINETTO E GABBIETTA

COVER FOR REAR WHEEL AXLE,  
COMPLETE OF BEARING AND CAGE

(Sim. 4354215)



ART. **16210**

CUSCINETTO **17x40x12 (SKF 6203-2RSH)**  
DUE LATI SCHERMATI

PER COPERCHIO ASSE RUOTA POSTERIORE

BEARING FOR REAR WHEEL AXLE COVER  
TWO SCREENED SIDES



ART. **16303-2RS**

CUSCINETTO **17x47x14 (SKF 6303-2RSH)**  
DUE LATI SCHERMATI

BEARING TWO SCREENED SIDES

(Sim. 82545R - 432305)

PER AMMORTIZZATORE POSTERIORE  
FOR REAR SHOCK ABSORBER:

### PIAGGIO

BEVERLY RST 125 (06-07)-EU3 125 (07-08)  
BEVERLY TOURER EU3 125/250 (08-09)  
BEVERLY EU3 SPORT 125 (07-08)  
BEVERLY EU3 MIC 125-250 (07)  
BEVERLY 200/250 (07-08) - IE EU3 250 (06-08)  
BEVERLY SPORT 250 (06-08)  
BEVERLY 300 IE TOURER (09)  
BEVERLY EU3 400/500 (06-09)  
BEVERLY 500 (05-06)  
CARNABY 125 (07-09)  
CRUISER 250/300/500 (07-09)  
MP3 125 (07-08) - MP3 IE 125 (08-09)  
MP3 125 IBRIDO (09) - MP3 250 (06-08)  
MP3 400 (07-08) - MP3 MIC 400 (08-09)  
VESPA GT 125-200(06-07)  
VESPA GT 60 EU3 250 (06-07)  
VESPA GTS EU3 125 (07-09)  
VESPA GTS 4T IE SUPER 125 (09)  
VESPA GTS ABS 250 (05-09)  
VESPA GTS SUPER 300 (08)  
VESPA GTV 125 (07-08)-GTV 250 (06-09)  
VESPA GTV 4T NAVY EU3 125-250 (08)  
X-EVO 400 (07-09)  
X9 EVOLUTION 125 (05-06) - X9 EU3 125 (07)  
X9 250 (06)-X9 500 (06-07)-X9 ABS 500 (06-07)

### GILERA

FUOCO 500 ('07-'08)  
NEXUS EU3 125 ('07-'08) - EU3 IE 125 ('08-'09)  
NEXUS EU3 250 ('06-'07) - EU3 300 ('08-'09)  
NEXUS SP EU3 250-500 ('06-'07)  
NEXUS EU3 500 ('06-'09)-  
RUNNER VX 125 (05-06)-VX EU3 4T 125 (07)  
RUNNER VX ST EU3 4T (08-09)  
RUNNER VX RACE 125 (06)  
RUNNER VXR 200 (05-06)  
RUNNER VXR ST EU3 4T 200 (08-09)  
RUNNER VXR RACE 200 ('06)  
RUNNER VXR EU3 200 (07)

PER RUOTA POSTERIORE  
FOR REAR WHEEL:

### PIAGGIO

BEVERLY 500 ('02-'04)  
HEXAGON GTX 125-180 ('00)  
X7 EVO IE EU3 125-300('09)  
SFERA 125 ('95-'97)-SKIPPER 125 ('94-'97)  
SUPER HEXAGON GTX 12" 125 ('01-'02)  
VESPA GT 125-200 ('03-'05)  
X9 250 ('00-'01)

PER BRACCIO OSCILLANTE  
FOR SWINGING ARM:

### PIAGGIO

X-EVO 125-250 ('07)  
X7 EU3 125-250 ('08)  
X7 EVO IE EU3 125-300('09)  
X8 125 ('05-'06)-X8 200 ('05-'07)  
X8 EU3 250 ('05-'08)  
X8 PREMIUM EU2 125 ('06)  
X8 PREMIUM EU3 125 ('06-'07)

PER INGRANAGGI TRASMISSIONE  
FOR TRANSMISSION GEARS:

### PIAGGIO

HEXAGON 125-150 ('94-'97)  
HEXAGON LX-LXT 125/180 ('98-'99)  
HEXAGON LX4 125 ('98-'99)  
LIBERTY 125 ('98-'00)  
SKIPPER 125 ('98-'99)  
VESPA ET4 125 ('96-'98)

### GILERA

RUNNER FX-FXR 125-180 ('97-'02)  
TYPHOON 125 ('95-'98)  
TYPHOON X-XR 125 ('99-'00)

PER AMMORTIZZATORE ANTERIORE  
FOR FRONT SHOCK ABSORBER:

### PIAGGIO

MP3 LT 250-400 ('09)  
MP3 MIC 250-400 ('08-'09)





## RICAMBI ASSE RUOTA POST. REAR WHEEL AXLE SPARE PARTS



ART. **6622-KT**

**KIT** SCODELLINO, DADO E COPPIGLIA  
PER ASSE RUOTA POSTERIORE

SET OF CAP SEC NUT + NUT + SPLIT PIN  
FOR REAR WHEEL AXLE

SCOOTER **PIAGGIO - GILERA**

VESPA PK - PK XL - N - FL2  
VESPA PX PE ARCOBALENO



ART. **6622**

SCODELLINO RUOTA POSTERIORE  
CAP SEC NUT REAR WHEEL AXLE  
(Sim. 194423)



ART. **6623**

DADO RUOTA POSTERIORE  
REAR WHEEL AXLE NUT  
(Sim. 194424)



ART. **6627**

COPPIGLIA  
SPLIT PIN FOR REAR WHEEL AXLE



ART. **5170-C**

TAPPO CROMATO (TIPO GRANDE) COPRI DADO MOZZI RUOTA  
CHROMED PLUG (BIG SIZE)

(Sim. 1C000523-092517-182546)

### PIAGGIO

FLY 50 4T ('05-'08)-FLY 4T MOTORI CHIN. 50 ('06-'07)-FLY 4T 100 ('06-'08)-FLY EU3 125 ('07-'08)  
FLY EU3 150 ('08) - HEXAGON GTX 125-180('00)  
LIBERTY 2T 50('06) - 2T SPORT 50 ('06-'08) - 4T 50('05-'08) - 4T SPORT 50 ('06-'08)  
MP3 125 ('07-'08)-250 ('06-'08)-400('07-'08)  
VESPA ET2 50 ('97-'05)-VESPA ET4 125-150 ('99-'02)  
GRANTURISMO 125 ('03-'07)-GRANTURISMO 200('06-'07)-GRANTURISMO EU3 125('06-'07)  
VESPA GT 60 EU3 250('06-'07) - GTS EU3 125('07-'08)-GTS SUPER 300('08)-GTS ABS 250('05-'08)  
VESPA GTV 125('07-'08)-250 ('06-'07)-GTV 4T NAVY EU3 125-250('08)  
VESPA LX 2T 4T 50 ('05-'08)-LX 125('05-'06)-LX EU3 125('06-'08)-LX 150('05-'06)  
VESPA LX EU3 150('06-'08) - LXV 2T 50('06-'08)-LXV 2T NAVY 50('08)-LXV 4T EU3 50-125('06-'08)  
VESPA LXV 4T NAVY EU3 125 ('08) - VESPA S 2T 50 ('07-'08) - VESPA S 4T EU3 125 ('07-'08)  
ZIP RST 50 ('96-'99)-ZIP SP 50 ('96-'00)-ZIP SP EU2 50 ('06-'08)-ZIP 4T 50-100 ('06-'08)-ZIP 125 ('00-'02)

ANTERIORE-POSTERIORE / FRONT-REAR: VESPA 50-90-125 PRIM.-ET3-125 T5 -PX PE ARCOB.  
SOLO POSTERIORE / ONLY REAR: VESPA PX PE 1<sup>sr</sup>.

### GILERA

FUOCO 500 ('07-'08)

## MOLLE CAVALLETTO

### STAND SPRINGS



ART. **5514-NT**

MOLLA CAVALLETTO  
STAND SPRING

(Sim. 278940)

#### APRILIA

MOJITO CUSTOM 2T MOT.PIAGGIO 50 ('04-'10)  
SCARABEO 2T 50 ('14) - 2T EU2 MOT.PIAGGIO 50 ('10-'12)  
SCARABEO 2T NET 50 ('09-'10) - STREET 2T RST 50 ('06-'09)  
SPORT CITY ONE 2T 50 ('08-'11) - SR MOTARD 2T 50 ('12-'14)  
SR INIEZIONE E CARBURATORE 50 ('14)  
SR R FACTORY IE E CARBURATORE 50 ('10-'14)  
SR R - R FACTORY 50 ('04-'09) - SR STREET 50 ('03-'12)

#### GILERA:

DNA 50 - DNA GP EXPERIENCE 50 - EASY MOVING 50-ICE 50  
RUNNER 50-POGGIALI 50 - PUREJET 50-SP 50  
RUNNER SP SPEC.EDITION 50 - SP ST & SIMONCELLI 50  
STALKER 50-SPEC.EDIT.50-STORM 50-STORM EU2 50  
TYPHOON 50 - TYPHOON X 50 - TYPHOON XR 50

#### PIAGGIO:

DIESIS 50 - FLY 2T 50  
FREE 50 - FREE DELIVERY 50-FREE FL 50  
LIBERTY 50-2T 50-RST 2T 50 - SPORT 2T 50  
LIBERTY MOC 2T & ELLE 50 - 125 ('98-'00)  
NRG 50-NRG EXTREME 50-NRG MC3 50-NRG POWER DD/DT 50  
NRG POWER PUREJET - NRG RST MC2 50 - NTT 50 - QUARTZ  
SFERA 50/125-SFERA MAQUILLAGE 2 50-SFERA RST 50  
VESPA ET2 50 - ET2 INIEZIONE 50 - ET4 125  
VESPA LX 2T 50-LX 2T TOURING & 30 KM. 50  
VESPA LXV 2T 50 - LXV NAVY 2T 50  
VESPA PRIMAVERA 2T 2V 50 ('13-'16) -  
VESPA S 2T & COLLEGE 50  
VESPA SPRINT 2T 2V 50 ('14-'16)  
ZIP 50 - 2T 50 - BIMODALE 50 - RST - SP 50 - SP EU2 50



ART. **10074-KT**

KIT MONTAGGIO CAVALLETTI CENTRALI CON FORI Ø mm.12  
KIT FOR CENTRAL STAND WITH HOLES Ø mm.12

KIT Composto da / KIT composed of:

CIF ART.	Rif.OEM	Descrizione / Description
3094	583603	Perno Ø mm.12x126 con seeger / pin with seeger
5514-NT	278940	MOLLA (uguale) DX/SX (Nr. 2 pz) (same spring RH/LH)

#### APRILIA

SPORT CITY ONE 2T 50 ('08-'11)  
SR MOTARD 2T 50 ('12-'14)

#### GILERA

EASY MOVING 50 ('95-'96).  
ICE 50 ('01-'05)  
STORM 50('94-'95)  
RUNNER 50 ('97-'00) - RUNNER POGGIALI 50('02)  
RUNNER PUREJET 50 ('02-'11) - PUREJET ST 50('08)  
RUNNER SP 50('02-'12) - RUNNER SP EDIZ.SPEC.50('07)  
RUNNER SP ST & SIMONCELLI 50('08-'09)  
STALKER 50 ('97-'11) - STALKER SPEC.EDITION 50 ('07-'08)  
STALKER NAKED 50 ('08)  
STORM EU2 50 ('07)  
TYPHOON 50 ('94-'97) - X 50 ('98-'99) - XR 50 ('00)

#### PIAGGIO

DIESIS 50 ('01)  
FLY 2T 50 ('05-'11)  
FREE 50 ('92-'94) - FREE FL 50 ('95-'02)  
LIBERTY 50('97-'05) - 2T 50 ('06-'08)  
LIBERTY 2T RST 50('04)  
LIBERTY SPORT 2T 50 ('06-'08)  
LIBERTY MOC 2T & ELLE 50 ('09-'13)  
LIBERTY PTT EU2 50 ('04-'05)  
NRG 50('94-'96) - NRG RST MC2 50 ('96-'98)  
NRG EXTREME 50('99-'00) - NRG MC3 50('01-'04)  
NRG PUREJET 50 ('02-'01) - NRG POWER DD 50 ('05-'15)  
NRG POWER DT 50 ('06-'15) - POWER PUREJET 50 ('04-'11)  
QUARTZ 50 ('92-'96)  
SFERA 50 ('91-'93) - MAQUILLAGE 50 ('94) - RST 50 ('95-'97)  
VESPA ET2 50 ('97-'05)  
VESPA ET2 INIEZIONE 50 ('97-'00)  
VESPA LX 2T 50 ('05-'13)  
VESPA LX 2T TOURING & 30 KM. 50 ('10-'13)  
VESPA LXV 2T 50 ('06-'09)  
VESPA LXV 2T NAVY 50 ('08)  
VESPA PRIMAVERA 2T 50 ('13-'16)  
VESPA S 2T 50('07-'12)  
VESPA SPRINT 2T 2V 50 ('14-'16)  
ZIP 50('92-'93) - ZIP 2T 50 ('08-'13) -  
ZIP RST('96-'99)  
ZIP SP 50 ('96-'04)  
ZIP SP EU2 50('06-'13)



ART. **3094**

PERNO Ø mm. 12x126 CON SEEGER

(Sim. 583603)





