



generico

ricambi • spare parts

ADESIVI
APPOGGIAPIEDI
ATTACCHI CANDELE
CHIAVI CANDELE
COMANDI-LEVE
DADI - RONDELLE - VITI
FASCETTE
GUAINA
LAMBRETTA RICAMBI
LAMPADINE
MANOPOLE
MORSETTI
PORTA TARGA
PRODOTTI CHIMICI
RUBINETTI E TUBI BENZINA
SFERE UTILIZZI VARI
SILENT BLOCK

ADHESIVE
BALLS
BRACKETS
CHEMICAL PRODUCTS
CLAMPS
FUEL COCKS & TUBE
GEAR CABLE CLAMPS
GRIPS
LAMBRETTA SPARE PARTS
LICENCE PLATE HOLDER
LIGHT BULBS
NUTS - WASHERS - SCREWS
SHEATS
SILENT BLOCK
SPARK PLUG TOOLS
THROTTLE CONTROLS/LEVERS

**Le categorie dei prodotti sotto riportate e presenti
in questa sezione sono elenchi riepilogativi.**

Ulteriori specifiche o singole immagini sono visionabili nelle relative sezioni
Scooter, Vespa, Ape e Ciclomotori

The products categories in this section below mentioned are summary lists.
Further specifications or single images can be viewed in the relevant
Scooter, Vespa, Ape and Mopeds sections

ALBERI MOTORE
CARBURATORI
CUSCINETTI
PARAOILI

BEARINGS
CARBURETORS
CRANKSHAFT
OIL SEALS



DELLORTO



mazzucchelli



ROLF





INDICE FASCICOLO GENERICO

GENERIC BOOKLET INDEX

| Prodotti | Pag. catalogo | Products | Page catalog |
|---|----------------------|--|---------------------|
| A desivi | 236->238 | A dhesive decorations | 236->238 |
| A lberi motore (tabella riepilogativa) | 200->204 | A djustment for gear cable, brake and clutch levers | 232 |
| A ntiwear motor oil | 242 | A ntiwear motor oil | 242 |
| A mmortizzatori LAMBRETTA | 255 | B earing (complete list) | 215 |
| A nelli di tenuta (tabella riepilogativa) | 205->211 | B alls | 212 |
| A nellini OR | 212 | B ostick | 239 |
| A ppoggiapiedi | 199 | B oxes for small parts | 235 |
| A ttacchi candela | 227->229 | B rake levers | 245 |
| B arilotti x leve comandi | 232 | B rake shift sleeve | 245->248 |
| B obina accensione LAMBRETTA | 256 | B rake pads and brake shoes LAMBRETTA | 259 |
| B ussolette a gradino | 232 | B ulbs list | 223->224 |
| C andele | 226 | B ushes | 232 |
| C apoguaina zincati | 232 | C arbon paper | 237 |
| C arbon paper | 237 | C able clamps | 232 |
| C arburatori e materiale inerente | 181->195 | C arburetor and spare parts | 181->195 |
| C atarinfrangente | 222 | C hemicals products | 239->244 |
| C avi candela | 230 | C lamps | 198 |
| C hiavi candela | 225 | C lamps carburetor | 193 |
| C ollarini per tubo benzina | 198 | C lamps for gear cable | 232 |
| C omandi gas - portaleva | 245->248 | C lutch levers | 245 |
| C ontenitori x minuteria | 235 | C ontacts electrical cleaner spray | 240 |
| C rema e saponi liquidi lavamani | 244 | C rankshafts (complete list) | 200->204 |
| C uscinetti (tabella riepilogativa) | 215 | C rankshafts revision KIT (complete list) | 216 |
| D adi | 234 | D ellorto Carburetors and spare parts | 181->195 |
| D ecorazioni adesive | 237->238 | E ngine washer spray | 240 |
| D ellorto Carburatori e ricambi | 181->195 | E mblems 3D ITALY | 237 |
| E mulsiatore carburatore | 188 | F loats for carburetor | 189 |
| E rmetico liquido | 239 | F loat chamber for carburetor | 190 |
| F ascette carburatore | 193 | F ootrest | 199 |
| F ascette in acciaio | 198 | F uel cocks | 196 |
| F ascette in nylon | 198 | F uel tube | 197 |
| G alleggianti carburatore | 189 | F uel filtre | 197 |
| G anasce freno LAMBRETTA | 259 | F uel tube clamps | 198 |
| G etti carburatore | 186->188 | F uel tube collars | 198 |
| G onfia e ripara | 243 | G asket set for carburetor | 192 |
| G rosso | 241 | G asket set LAMBRETTA | 258 |
| G uaina | 230->231 | G ear cable clamps, screw in head | 232 |
| G uarnizioni carburatore | 192 | G rease | 241 |
| K it revisione alberi motore (tabella riepilogativa) | 216 | G rips | 249->254 |
| L ambretta ricambi | 255->260 | H andwash professional | 244 |
| L ampadine | 223->224 | I nsulating reduction connection for carburetor | 193 |
| L avamotori e grassante spray | 240 | K egs for lever | 232 |
| L eve freno - frizione | 245 | K IT for crankshafts revision (complete list) | 216 |
| L iquido refrigerante per radiatore | 242 | J et for carburetors | 186->188 |
| | | L ambretta spare parts | 255->260 |
| | | L ambretta shock-absorbers | 255 |



INDICE FASCICOLO GENERICO

GENERIC BOOKLET INDEX

| Prodotti | Pag. catalogo | Products | Page catalog |
|--|----------------------|--|---------------------|
| Manopole | 249->254 | <i>Leather, natural</i> | 244 |
| Mastice Rosso-Nero per guarnizioni | 239 | <i>Levers, clutch/brake/decompression</i> | 245 |
| Microfiltri benzina | 197 | <i>Levers, kegs</i> | 232 |
| Minuteria per guaine | 232 | <i>License plate holder</i> | 217->221 |
| Misurini olio-miscela | 196 | <i>Liquid cooling</i> | 242 |
| Molle tringi tubo benzina | 198 | <i>Mastic, red and black for gaskets</i> | 239 |
| Morsetti serrafilto | 232 | <i>Measuring cups for to mix fuel oil</i> | 196 |
| | | <i>Mixer tube for carburetor</i> | 188 |
| Paraoli (tabella riepilogativa) | 205->211 | <i>Needles for carburetors</i> | 185 |
| Passacavi in INOX | 198 | <i>Nuts</i> | 234 |
| Pasta lavamani | 244 | <i>Oil seals (complete list)</i> | 205->211 |
| Pastiglie freno LAMBRETTA | 259 | <i>Oil seals set (complete list)</i> | 213->214 |
| Pelle naturale scamosciata | 244 | <i>O-rings</i> | 212 |
| Piastrine per viti autofilettanti | 235 | <i>Pads, brake LAMBRETTA</i> | 259 |
| Pipette di raccordo carburatore | 191 | <i>Pass cable in INOX steel+anti vibration rubber</i> | 198 |
| Porta targa | 217->221 | <i>Pipets connection carburetor</i> | 191 |
| Prodotti chimici | 239->244 | <i>Plate for self-tapping screws</i> | 235 |
| Protezione serbatoio | 238 | <i>Polish</i> | 243 |
| | | <i>Pump repair tyre</i> | 243 |
| Registri per fili cambio, leve freno e frizione | 232 | <i>Reflector</i> | 222 |
| Ricambi Lambretta | 255->259 | <i>Remove scratches for body</i> | 243 |
| Riduzioni isolanti carburatore | 193 | <i>Screws</i> | 233 |
| Rondelle | 234 | <i>Screws fix carburetor float chamber</i> | 190 |
| Rubinetti benzina | 196 | <i>Sealant</i> | 239 |
| | | <i>Shampoo for car and motorcycles</i> | 244 |
| Scudetti 3D ITALIA | 237 | <i>Sheat</i> | 230->231 |
| Serie paraoli (tabella riepilogativa) | 213->214 | <i>Shock absorbers for LAMBRETTA</i> | 255 |
| Serie guarnizioni carburatore | 192 | <i>Shoes, brake LAMBRETTA</i> | 259 |
| Serie guarnizioni Lambretta | 258 | <i>Silentblocks</i> | 199 |
| Serrafilotti | 240 | <i>Spark plug</i> | 226 |
| Sfere | 212 | <i>Spark plug cable</i> | 230 |
| Shampoo auto/moto | 244 | <i>Spark plug cap</i> | 230 |
| Silentblock | 199 | <i>Spark plug connections</i> | 227->229 |
| Spilli carburatore | 185 | <i>Spark plug tools</i> | 225 |
| Sigillante | 239 | <i>Spray engine washer</i> | 240 |
| Spray block | 240 | <i>Spray for cleaner contacts electrical</i> | 240 |
| Spray pulitore contatti elettrici | 240 | <i>Spray block</i> | 240 |
| Starter automatico, manuale, modifica x carburatore | 194->195 | <i>Springs sec fuel tube</i> | 198 |
| | | <i>Standings pair</i> | 199 |
| Tamburo posteriore LAMBRETTA | 260 | <i>Starter, automatic, manual, modified for carburetor</i> | 194->195 |
| Togli graffi per carrozzeria | 243 | <i>Tank protections</i> | 238 |
| Tubo benzina | 197 | <i>Terminal fixing sheat, zined</i> | 232 |
| | | <i>Threadlocking</i> | 240 |
| Valvole gas | 189 | <i>Throttle controls</i> | 245-248 |
| Vaschette carburatore | 190 | <i>Throttle valve</i> | 189 |
| Vernici marmitta | 243 | <i>Varnish spray for exhaust</i> | 243 |
| Viti autofilettanti | 233 | <i>Washers</i> | 234 |
| Viti fissaggio vaschetta carburatore | 190 | <i>Wheel stripe</i> | 236 |
| Viti regolazione minimo carburatore | 189 | | |
| Viti testa esagonale | 233 | | |
| Wheel stripe | 236 | | |

DELLORTO

CARBURATORI CARBURETORS

SCOOTER



| | | | |
|----------------------|--------------|-------------|--|
| ART. 12272 | PHBL 24 BS | (DELL.2724) | SCOOTER - VESPA |
| ART. 12273-4T | PHBL 24 AD | (DELL.2716) | SCOOTER - VESPA MOTORI 4 TEMPI/STROKE |
| ART. 12247 | PHBN 12 HS | (DELL.3046) | MBK BOOSTER |
| ART. 12250 | PHBN 12 GS | (DELL.3069) | APRILIA SCARABEO - MOTORI MINARELLI 50 cc. |
| ART. 12227 | PHBN 17,5 LS | (DELL.3067) | MOTORI MINARELLI - YAMAHA - MBK BOOSTER |
| ART. 12243 | PHVA 12 QD | (DELL.8348) | PIAGGIO ZIP-FAST RAIDER - ZIP RST |
| ART. 12244 | PHVA 12 QD | (DELL.8330) | PIAGGIO NRG - NTT - GILERA TYPHOON - STORM |
| ART. 12245 | PHVA 12 QD | (DELL.8402) | PIAGGIO - GILERA |
| ART. 12249 | PHVA 12 PS | (DELL.1391) | MALAGUTI F12 PHANTOOM |
| ART. 12234 | PHVA 17,5 ED | (DELL.1012) | MOTORI PIAGGIO-GILERA |
| ART. 12246 | PHVA 17,5 TS | (DELL.1389) | MALAGUTI F10 - F12 |
| ART. 12233 | PHVA 17,5 US | (DELL.1438) | HONDA SKY - X8R - SFX - SGX |

SCOOTER e GENERICI

| | | | |
|----------------------|--------------|-------------|---|
| ART. 12282 | PHBG 19 BS | | MOTORI MINARELLI - YAMAHA |
| ART. 12238-AE | PHBG 19 DS | | MOTORI MINARELLI - YAMAHA |
| ART. 12283 | PHBG 19 DS | (DELL.2695) | MOTORI MINARELLI - YAMAHA VERSIONE NERA / BLACK VERSION |
| ART. 12239-AE | PHBG 21 DS | | MOTORI MINARELLI - YAMAHA |
| ART. 12285 | PHBG 21 DS | (DELL.2696) | MOTORI MINARELLI - YAMAHA VERSIONE NERA / BLACK VERSION |
| ART. 12259 | PHVB 20,5 ED | | PIAGGIO SKIPPER LX-LXT 125/150 ('99) GILERA TYPHOON 125 CAT. ('99) |
| ART. 12280 | PHVB 20,5 ED | | KIT RACING (PISTA/TRAIL) REGOLAZIONE DX / RH ADJUSTMENT |





CARBURATORI
CARBURETORS

DELLORTO

GENERICI



ART. **12237**

PHBG 19 CS CON MIX

(DELL.2575)

ATTACCO RIGIDO da diametro 26 a diametro 24
Getto massimo 75 (CIF art. 11076)

MOTO



ART. **12238**

PHBG 19 AS SENZA MIX

(DELL.2506)

ATTACCO RIGIDO da diametro 26 a diametro 24
Getto massimo 85 (CIF art. 11085)

MOTO



ART. **12239**

PHBG 21 CS CON MIX

(DELL.2633)

ATTACCO RIGIDO da diametro 26 a diametro 24
Getto massimo 92 (CIF art. 11092)

MOTO

DELLORTO

CARBURATORI CARBURETORS

VESPA



| | | | | | |
|----------------------|--------------|-------------|-------------------------|--|---------------|
| ART. 12226 | SHB 16-10 | (DELL. 753) | VESPA 50 | | (Sim. 97587) |
| ART. 12228 | SHB 16-16 | (DELL. 764) | VESPA 50 SPECIAL | | (Sim. 150600) |
| ART. 12235 | SHB 16-10 F | (DELL. 917) | VESPA PK 50 XL | | (Sim. 245425) |
| ART. 12232 | SHB 16-16 F | (DELL. 879) | VESPA PK 50 XL | | (Sim. 196930) |
| ART. 12236 | SHB 16-12 M | (DELL. 926) | VESPA PK 50 RUSH N | | (Sim. 246940) |
| ART. 12216 | SHB 16-12 N | (DELL. 936) | VESPA PK 50 FL | (starter modificato/modified) | (Sim. 286700) |
| ART. 12215 | SHBC 19-19 | (DELL. 773) | VESPA 125 PRIMAVERA | | (Sim. 196227) |
| ART. 12205 | SHBC 19-19 E | (DELL. 866) | VESPA PK 125 | | (Sim. 178685) |
| ART. 12218 | SHBC 19-19 E | (DELL. 943) | VESPA PK 125 FL | (starter modificato/modified) | (Sim 288173) |
| ART. 12297 | SHBC 20 L | (DELL. 941) | VESPA PK 125 FL2 | | (Sim 287152) |
| ART. 12298 | SHBC 20 L | (DELL. 909) | VESPA P125 TS | | (Sim 242951) |
| ART. 12241 | SI 20-20 D | (DELL. 587) | VESPA PX 125 | | |
| ART. 12241-M | SI 20-20 D | (DELL. 585) | VESPA PX 125 | con/with MIX | |
| ART. 12292 | SI 20-20 D | (DELL. 588) | VESPA PX 150 | | |
| ART. 12292-M | SI 20-20 D | (DELL. 590) | VESPA PX 150 | con/with MIX | |
| ART. 12242 | SI 24-24 E | (DELL. 586) | VESPA P 200 E | | |
| ART. 12242-M | SI 24-24 E | (DELL. 583) | VESPA P 200 E | con/with MIX | |
| ART. 12293 | SI 24-24 G | (DELL. 593) | VESPA T5 125 | | |
| ART. 12293-M | SI 24-24 G | (DELL. 594) | VESPA T5 125 | con/with MIX | |
| ART. 12289 | SI 26-26 E | (DELL. 617) | VESPA PX PE 200 | con/with MIX | |
| ART. 12290 | SI 26-26 G | (DELL. 618) | VESPA T5 125 | con/with MIX | |
| ART. 12276 | PHBL 24 AS | (DELL.2715) | ADATTABILE VESPA | REGOLAZIONE SX / LH ADJUSTMENT | |
| ART. 12275 | PHBL 24 AD | (DELL.2733) | ADATTABILE VESPA | REGOLAZIONE DX / RH ADJUSTMENT | |
| ART. 12273-4T | PHBL 24 AD | (DELL.2716) | ADATTABILE VESPA | MOTORI 4 TEMPI / STROKE | |
| ART. 12275-M | PHBL 24 BD | (DELL.2762) | ADATTABILE VESPA-APE 50 | REGOLAZIONE DX attacco MIX / RH ADJUSTMENT | |
| ART. 12272 | PHBL 24 BS | (DELL.2724) | ADATTABILE VESPA | | |



CARBURATORI CARBURETORS

DELLORTO

APE



| | | | | | |
|---------------------|--------------|-------------|-------------------------|--|---------------|
| ART. 12275-M | PHBL 24 BD | (DELL.2762) | ADATTABILE APE 50-VESPA | REGOLAZIONE DX attacco MIX / RH ADJUSTMENT | |
| ART. 12256 | SHB 22-17 B | (DELL. 843) | APE P 601 | | (Sim. 183061) |
| ART. 12254 | SHB 27-24 | (DELL. 834) | APE P 501 | | |
| ART. 12255 | SHB 27-24 | (DELL. 777) | APE MP | | (Sim. 125278) |
| ART. 12257 | SHBB 22-22 | (DELL. 959) | APE TM P 703 | | (Sim. 199451) |
| ART. 12251 | SHBC 18-16 A | (DELL. 896) | APE P 50 | | (Sim. 224893) |
| ART. 12252 | SHBC 18-16 N | (DELL. 938) | APE TM P 50 | | (Sim. 286890) |
| ART. 12253 | SHBC 18-16 P | (DELL. 958) | APE 50 RST | | |
| ART. 12258 | SHBC 19-19 F | (DELL. 905) | APE 50 con/with MIX | | |

CICLOMOTORI



| | | | | | | |
|-------------------|-------------|-------------|------------------|--------------------------------|-------|---------------|
| ART. 12201 | SHA 12-10 | (DELL.1821) | CIAO P - PX | tipo originale / original type | | (Sim. 188237) |
| ART. 12209 | SHA 12-12 | (DELL.2035) | CIAO PX FL | tipo originale / original type | | (Sim. 247287) |
| ART. 12206 | SHA 13-13 | (DELL.2044) | CIAO PX | | | |
| ART. 12210 | SHA 13-13 | (DELL.2046) | CIAO | | | |
| ART. 12207 | SHA 12-12 | (DELL.1800) | SI' | tipo originale / original type | | (Sim. 164148) |
| ART. 12200 | SHA 13-13 | (DELL.1851) | SI' | | | |
| ART. 12202 | SHA 12-12 | (DELL.1877) | BRAVO '82 | tipo originale / original type | | (Sim. 194853) |
| ART. 12203 | SHA 14-12 | (DELL.1515) | CICLOMOTORI VARI | | | |
| ART. 12220 | SHA 15-15 | (DELL.2043) | FBM - GARELLI | | | |
| ART. 12225 | SHA 15-15 G | (DELL.2013) | GARELLI | con/with MIX | | |

DELLORTO

SPILLI CHIUSURA BENZINA NEEDLES



ART. **11500** TRIANGOLARE / TRIANGULAR (DELL. 2838)
PER CARBURATORI SHA - SHB 16 - SHBC 18/19/20 - PHBG- FHBA-FHBB
VESPA 50 - 90 125 PRIMAVERA - PK - CICLOMOTORI - APE



ART. **11498** TRIANGOLARE TESTINA TONDA PICCOLA Ø mm. 2,5 (DELL. 15304.05)
MOLLA MORBIDA
TRIANGULAR - SMALL ROUND HEAD Ø mm. 2.5 - SOFT SPRING
PER CARBURATORI PHVA 17,5 TS .. - US ...
MALAGUTI F10 - F12 - HONDA SKY - X8R - SFX - SGX



ART. **11503** TRIANGOLARE MOLLEGGIATO (DELL. 11668)
TESTINA TONDA GROSSA Ø mm. 3,5
TRIANGULAR, SPRINGY - BIG ROUND HEAD Ø mm. 3,5
PER CARBURATORI PHBN - PHVA - PHVB
PIAGGIO SCOOTER



ART. **11502** QUADRATO - QUADRO / SQUARE mm. 3,5 (DELL. 4559)
PER CARBURATORI VESPA PX



ART. **11504** QUADRATO MOLLEGGIATO (DELL. 8080)
QUADRO mm. 3,5 - TESTA TONDA mm. 3,5
SQUARE, SPRINGY - SQUARE mm. 3,5 - ROUND HEAD mm.3,5
PER CARBURATORI VESPA PX - APE



ART. **11501** QUADRATO MOLLEGGIATO (DELL. 12202)
QUADRO mm. 4 - TESTA TONDA mm. 3,5
SQUARE SPRINGY NEEDLE - SQUARE mm. 4 - ROUND HEAD mm.3,5
PER CARBURATORI VESPA COSA

PER CARBURATORI PHBN - PHVA - PHVB

SCOOTER : PIAGGIO-GILERA 50/125/150/180 - motori MINARELLI-YAMAHA



ART. **11503-A** SPILLO TRIANGOLARE E MOLLEGGIATO (DELL. 15360)
MODIFICATO CON TESTINA TONDA PICCOLA Ø mm. 2,5
TRIANGULAR SPRINGY NEEDLE,
MODIFIED WITH SMALL ROUND HEAD Ø mm. 2.5



ART. **11503-KT** KIT GALLEGGIANTE + SPILLO (DELL. 53053-78)
TRIANGOLARE E MOLLEGGIATO MODIFICATO CON
TESTINA TONDA PICCOLA Ø mm. 2,5
KIT OF FLOAT AND TRIANGULAR SPRINGY NEEDLE,
MODIFIED WITH SMALL ROUND HEAD Ø mm. 2.5



GETTI CARBURATORE
CARBURETOR JETS

DELLORTO

TIPO PICCOLO FILETTO mm. 5

(DELLORTO 01486 ...)

| Articolo | Variante |
|----------------------------|----------|
| 11040 | 40 |
| 11042 | 42 |
| 11044 | 44 |
| 11046 | 46 |
| 11048 | 48 |
| 11050 | 50 |
| 11051 (SPECIFICO VESPA 50) | 51 |
| 11052 | 52 |
| 11054 | 54 |
| 11056 | 56 |
| 11058 | 58 |
| 11060 | 60 |
| 11062 | 62 |
| 11064 | 64 |
| 11066 | 66 |
| 11068 | 68 |
| 11070 | 70 |
| 11072 | 72 |
| 11074 | 74 |
| 11076 | 76 |
| 11078 | 78 |
| 11080 | 80 |
| 11082 | 82 |
| 11085 | 85 |
| 11087 | 87 |
| 11090 | 90 |
| 11092 | 92 |
| 11095 | 95 |
| 11098 | 98 |
| 11100 | 100 |
| 11102 | 102 |
| 11105 | 105 |
| 11108 | 108 |
| 11110 | 110 |
| 11112 | 112 |
| 11115 | 115 |
| 11118 | 118 |
| 11120 | 120 |
| 11122 | 122 |
| 11125 | 125 |
| 11130 | 130 |



Confezione minima
10 pz.

TIPO GROSSO FILETTO mm. 6

(DELLORTO 06413 ...)

| Articolo | Variante |
|----------|----------|
| 12054 | 54 |
| 12056 | 56 |
| 12058 | 58 |
| 12060 | 60 |
| 12062 | 62 |
| 12064 | 64 |
| 12066 | 66 |
| 12068 | 68 |
| 12070 | 70 |
| 12072 | 72 |
| 12074 | 74 |
| 12075 | 75 |
| 12078 | 78 |
| 12080 | 80 |
| 12082 | 82 |
| 12085 | 85 |
| 12088 | 88 |
| 12090 | 90 |
| 12092 | 92 |
| 12095 | 95 |
| 12098 | 98 |
| 12100 | 100 |
| 12102 | 102 |
| 12105 | 105 |
| 12107 | 107 |
| 12110 | 110 |
| 12112 | 112 |
| 12115 | 115 |
| 12118 | 118 |
| 12120 | 120 |
| 12125 | 125 |
| 12130 | 130 |
| 12135 | 135 |
| 12140 | 140 |
| 12145 | 145 |
| 12150 | 150 |
| 12155 | 155 |
| 12160 | 160 |
| 12165 | 165 |
| 12170 | 170 |



Confezione minima
10 pz.

GETTO MINIMO FILETTO mm. 5

(DELLORTO 01488 ...)

PER CARBURATORI
SERIE PHBG - PHBD



| Articolo | Variante |
|----------|----------|
| 14040 | 40 |
| 14042 | 42 |
| 14045 | 45 |
| 14048 | 48 |
| 14050 | 50 |
| 14052 | 52 |
| 14055 | 55 |
| 14060 | 60 |

Confezione minima
4 pz.

GETTO MASSIMO

(DELLORTO 04576 ...)

PER CARBURATORI SERIE SI 20-22-24 ...
PIAGGIO VESPA PX PE



| Articolo | Variante |
|----------|----------|
| 13090 | 90 |
| 13092 | 92 |
| 13095 | 95 |
| 13098 | 98 |
| 13100 | 100 |
| 13102 | 102 |
| 13105 | 105 |
| 13108 | 108 |
| 13110 | 110 |
| 13118 | 118 |
| 13120 | 120 |

Confezione minima
4 pz.



FILETTO/THREAD mm.5

GETTO MINIMO C/CALIBRAZIONE ARIA

IDLE JET WITH AIR CALIBRATION

VESPA PX

| | | | |
|----------------------|-----------------|---|-----------------|
| ART. 13200-01 | VAR.01 (48/160) | per carburatori SI 20..D - SI 24..E-G | (DELL.09892.01) |
| ART. 13200-04 | VAR.04 (55/160) | per carburatori SI 20..D - SI 24..E-G | (DELL.09892.04) |
| ART. 13200-05 | VAR.05 (38/120) | per carburatori SI 20..D - SI 24..E-G | (DELL.09892.05) |
| ART. 13200-07 | VAR.07 (52/140) | per carburatori SI 20..D - SI 24..E-G | (DELL.09892.07) |
| ART. 13200-08 | VAR.08 (45/140) | per carburatori SI 20..D - SI 24..E-G | (DELL.09892.08) |
| ART. 13200-09 | VAR.09 (50/160) | per carburatori SI 20..D - SI 24..E-G | (DELL.09892.09) |
| ART. 13200-11 | VAR.11 (48/140) | per carburatori SI 20..D - SI 24..E-G | (DELL.09892.11) |
| ART. 13200-12 | VAR.12 (52/120) | per carburatori SI 20..D - SI 24..E-G | (DELL.09892.12) |
| ART. 13200-16 | VAR.16 (45/120) | per carburatori SI 20..D - SI 24..E-G | (DELL.09892.16) |



FILETTO/THREAD mm.5

GETTO MINIMO

IDLE JET

VESPA - APE

| | | | |
|----------------------|--------|--|-----------------|
| ART. 13300-35 | VAR.35 | per carburatori SHB 16 F-G-H-L-M-N - SHBC 18-19-20 | (DELL.03360.35) |
| ART. 13300-38 | VAR.38 | per carburatori SHB 16 F-G-H-L-M-N - SHBC 18-19-20 | (DELL.03360.38) |
| ART. 13300-40 | VAR.40 | per carburatori SHB 16 F-G-H-L-M-N - SHBC 18-19-20 | (DELL.03360.40) |
| ART. 13300-42 | VAR.42 | per carburatori SHB 16 F-G-H-L-M-N - SHBC 18-19-20 | (DELL.03360.42) |
| ART. 13300-45 | VAR.45 | per carburatori SHB 16 F-G-H-L-M-N - SHBC 18-19-20 | (DELL.03360.45) |
| ART. 13300-48 | VAR.48 | per carburatori SHB 16 F-G-H-L-M-N - SHBC 18-19-20 | (DELL.03360.48) |
| ART. 13300-50 | VAR.50 | per carburatori SHB 16 F-G-H-L-M-N - SHBC 18-19-20 | (DELL.03360.50) |
| ART. 13300-55 | VAR.55 | per carburatori SHB 16 F-G-H-L-M-N - SHBC 18-19-20 | (DELL.03360.55) |



FILETTO/THREAD mm.8

CALIBRATORE ARIA MASSIMO

AIR CALIBRATOR JET

VESPA 125 T5

| | | | |
|-----------------------|---------|---|------------------|
| ART. 13400-120 | VAR.120 | per carburatori SI 24-24 G - SI 26-26 G | (DELL.04581.120) |
|-----------------------|---------|---|------------------|



FILETTO/THREAD mm.8

CALIBRATORE ARIA MASSIMO

AIR CALIBRATOR JET

VESPA PX

| | | | |
|-----------------------|---------|---|------------------|
| ART. 13500-120 | VAR.120 | per carburatori SI 20..D-H - SI 24..E-G-H | (DELL.05827.120) |
| ART. 13500-140 | VAR.140 | per carburatori SI 20..D-H - SI 24..E-G-H | (DELL.05827.140) |
| ART. 13500-160 | VAR.160 | per carburatori SI 20..D-H - SI 24..E-G-H | (DELL.05827.160) |
| ART. 13500-190 | VAR.190 | per carburatori SI 20..D-H - SI 24..E-G-H | (DELL.05827.190) |



RICAMBI CARBURATORI
CARBURETORS SPARE PARTS

DELLORTO

GETTO AVVIAMENTO

CHOKE JET

VESPA PX

ART. **13600-60** VAR. 60 per carburatori SI 20..D - SI 24..E-G VESPA PX (DELL.05582.60)



FILETTO/THREAD mm.6

GETTO AVVIAMENTO

CHOKE JET

VESPA - APE

ART. **13700-50** VAR. 50 per carburatori SHB 16 F-G-H-L-M-N - SHBC 18-19-20 VESPA - APE (DELL.06217.50)
ART. **13700-60** VAR. 60 per carburatori SHB 16 F-G-H-L-M-N - SHBC 18-19-20 VESPA - APE (DELL.06217.60)



FILETTO/THREAD mm.5

GETTO AVVIAMENTO

CHOKE JET

ART. **13800-45** VAR. 45 per carburatori PHBH - PHBL - PHS - PHM (DELL.07746.45)
ART. **13800-50** VAR. 50 per carburatori PHBH - PHBL - PHS - PHM (DELL.07746.50)
ART. **13800-55** VAR. 55 per carburatori PHBH - PHBL - PHS - PHM (DELL.07746.55)
ART. **13800-60** VAR. 60 per carburatori PHBH - PHBL - PHS - PHM (DELL.07746.60)
ART. **13800-65** VAR. 65 per carburatori PHBH - PHBL - PHS - PHM (DELL.07746.65)



FILETTO/THREAD mm.5

EMULSIONATORE

MIXER TUBE

VESPA PX

ART. **13900-01** BE MIS.1 per carburatori SI 20..D-H - SI 24..E-G-H VESPA PX (DELL.05353.BE1)
ART. **13900-02** BE MIS.2 per carburatori SI 20..D-H - SI 24..E-G-H VESPA PX (DELL.05353.BE2)
ART. **13900-03** BE MIS.3 per carburatori SI 20..D-H - SI 24..E-G-H VESPA PX (DELL.05353.BE3)
ART. **13900-05** BE MIS.5 per carburatori SI 20..D-H - SI 24..E-G-H VESPA PX (DELL.05353.BE5)



DELLORTO

RICAMBI CARBURATORI
CARBURETORS SPARE PARTS

VALVOLE GAS
THROTTLE VALVES



11512



11513



11651

MOLLE RICHIAMO VALVOLE GAS
THROTTLE VALVES SPRINGS



11543

11545

11548

VITI REGOLAZIONE MINIMO
ADJUSTMENT MINIMUM FUEL SCREWS



11541

11542

MOLLA TENUTA VITE REGOLAZ. MINIMO
ADJUSTMENT MINIMUM FUEL SCREW SPRING



11547

GALLEGGIANTI
FLOATS



11530



11531



11534



DELLORTO

| CIF ART. | DELLORTO ART. | DESCRIZIONE DESCRIPTION | PER CARBURATORE FOR CARBURETOR | APPLICAZIONI APPLICATIONS |
|--------------|---------------|----------------------------|---|-----------------------------------|
| 11512 | 9475.40 | VALVOLA GS | PHBG 15-16-17-18-19-20-21 con e senza MIX | |
| 11513 | 13685.40 | VALVOLA GAS | PHVA 12 ... | PIAGGIO SCOOTER |
| 11530 | 7420.80.01 | GALLEGGIANTE | SHA 10 ..- 12 ..- 13 .. | SI' - CIAO - BRAVO |
| 11531 | 6122.80.01 | GALLEGGIANTE | SHA 14..- 15..-SHB 16..-SHBC 19.. | CICLOMOTORI vari e VESPA-APE 50 |
| 11534 | 4567.80 | GALLEGGIANTE | | VESPA PX PE TUTTI TIPI |
| 11543 | 7413.61 | MOLLA VALVOLA GAS | SHA 10-12-13 | CIAO - BRAVO - SI'.. |
| 11545 | 6455.61 | MOLLA VALVOLA GAS | SHB 16 | VESPA 50 - PK 50 |
| 11548 | 5951.61 | MOLLA VALVOLA GAS | SHB 19-SHBC 19 | VESPA PRIMAVERA - ET3 - PK125 ... |
| 11651 | 15362.64 | VALVOLA GAS | PHBN 17,5 | MOTORI MINARELLI-YAMAHA |
| 11541 | 3357.33 | VITE REGOLAZIONE MINIMO | SHB .. - SHBC .. - 16.. - 19.. | VESPA PK..... |
| 11542 | 9517.37 | VITE REGOLAZIONE MINIMO | PHBG 19.. - 20.. - 21.. | |
| 11547 | 9336.61 | MOLLA X VITE REGOL. MINIMO | SHBC.. - PHBG.. | VESPA e vari |



RICAMBI CARBURATORI CARBURETORS SPARE PARTS

DELLORTO

VASCHEE CON GUARNIZIONE FLOAT CHAMBER WITH GASKET



11550



11551



11552



11553



11554



11555



11556



11557

COPERCHIO VASCHETTA CARBURATORE FLOAT CHAMBER COVER



11645

VITI FISSAGGIO VASCHETTA SCREWS FIX FLOAT CHAMBER



11559



11560



11561



DELLORTO

| CIF ART. | DELLORTO ART. | DESCRIZIONE DESCRIPTION | PER CARBURATORE FOR CARBURETTOR | APPLICAZIONI APPLICATIONS |
|--------------|---------------|----------------------------|------------------------------------|--|
| 11550 | 13503.96 | VASCETTA | (SHA ..- 12 .. - 13 ..) | PIAGGIO CIAO - SI' |
| 11551 | 13412.96 | VASCETTA | (SHA 14 .. - 15 ..) | CICLOMOTORI VARI |
| 11552 | 13502.96 | VASCETTA | (SHBC ...) | VESPA TUTTI TIPI - APE 50 - APE P50 - APE RST 50 |
| 11553 | 9444.96 | VASCETTA | (PHBG 19...-20...-21...) | CICLOMOTORI E MOTO VARI |
| 11554 | 13678.96 | VASCETTA | (PHVA...-PHBN...-16...-17,5..) | PIAGGIO SFERA - MBK BOOSTER |
| 11555 | 14363.96 | VASCETTA | (PHVB...-PHVA 22 ...) | SCOOTER |
| 11556 | 15354.96 | VASCETTA | (PHVB...18 - 20,5 - 22) | PIAGGIO SCOOTER 125-150-180 |
| 11557 | 14699.96 | VASCETTA | (PHVA 17,5 TS) | MALAGUTI F10 - F12 |
| 11559 | 11836.36 | VITE | (PHBG 19...-20...- 21...) | |
| 11560 | 11837.36 | VITE | | CIAO - SI' CICLOMOTORI VARI-VESPA TUTTI TIPI |
| 11561 | 13709.36 | VITE | (PHVA - PHVB) | SCOOTER |
| 11645 | 1181900-954 | COPERCHIO | (SI 20...-24... D-E-G) | VESPA PX - PX PE |

DELLORTO

RICAMBI CARBURATORI CARBURETORS SPARE PARTS

PIPETTE DI RACCORDO FRA TUBO BENZINA E CARBURATORE

PIPETS CONNECTION
BETWEEN FUEL TUBE AND CARBURETTOR



11505



11509



11519



11519-A



11510



11511

FILTRINI SOTTO LA PIPETTA SMALL FILTERS UNDER THE PIPET



11506



11507



11507-A



11520

ELEMENTO FILTRANTE ARIA AIR FILTER ELEMENT



11508



| CIF ART. | DELLORTO ART. | DESCRIZIONE DESCRIPTION | PER CARBURATORE FOR CARBURETOR | APPLICAZIONI APPLICATIONS |
|----------------|---------------|----------------------------|--|------------------------------|
| 11505 | 9249 | PIPETTA | SHA 14 .. - SHA 15 .. | CICLOMOTORI VARI |
| 11506 | 6109 | FILTRINO | SHA 15 C .. - SHBC 18 A-18 B-18 D - SHBC 19..19 B - 19 D | APE e VESPA |
| 11507 | 3362 | FILTRINO | SHA 12 .. - SHA 13 .. | CICLOMOTORI vari |
| 11507-A | 6210 | FILTRINO | SHB 16-16 F - 16 G - 16 H - 16 L | VESPA |
| 11508 | 6117 | ELEMENTO FILTRANTE | SHA 12 - SHA 14 - SHA 15 | |
| 11509 | 6475 | PIPETTA | SHA 14 B-14 C-14 D - SHA 15 | CICLOMOTORI VARI |
| 11510 | 10918 | PIPETTA | SHB 16 F | VESPA PK |
| 11511 | 6517 | PIPETTA | SHBC 18 A - 18 C - 18 D) - SHBC 19 - 19 B - 19 D | APE e VESPA |
| 11519 | 6364.38 | PIPETTA | | PIAGGIO CIAO |
| 11519-A | 8106.38 | PIPETTA | | PIAGGIO SI' ART. |
| 11520 | 04187.29 | FILTRINO | SI 20-24 E-D-G-H | VESPA PX PE |



RICAMBI CARBURATORI
CARBURETORS SPARE PARTS

DELLORTO

SERIE GUARNIZIONI REVISIONE CARBURATORE
REVISION CARBURETTOR GASKETS SET

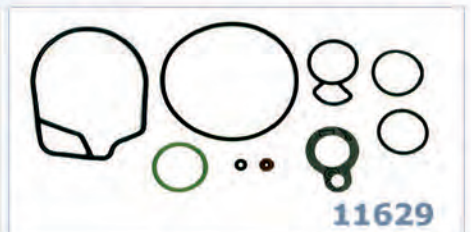
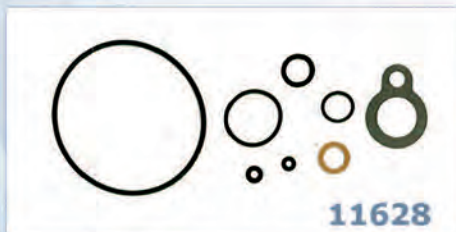
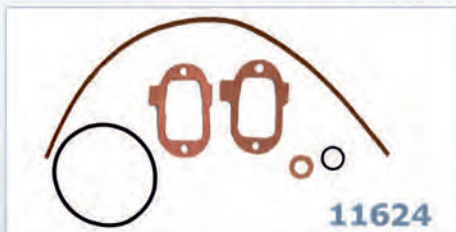
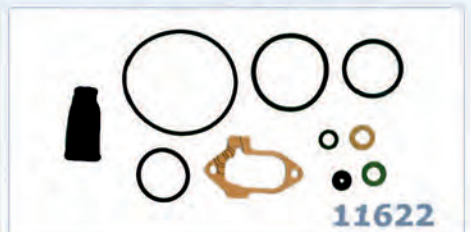
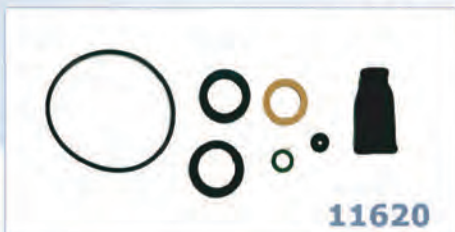
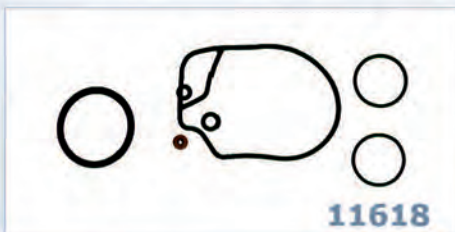

| CIF ART. | DELLORTO ART. | DESCRIZIONE DESCRIPTION | PER CARBURATORE FOR CARBURETOR | APPLICAZIONI APPLICATIONS |
|--------------|---------------|----------------------------|-----------------------------------|--|
| 11618 | 52625 | SR. GUARNIZIONI | PHVA 17,5 US - TS | HONDA - MALAGUTI |
| 11620 | 52540 | SR. GUARNIZIONI | SHA 10 - 12 - 13 | CICLOMOTORI PIAGGIO e vari |
| 11621 | 52533 | SR. GUARNIZIONI | SHA 14 - 15 | CICLOMOTORI VARI |
| 11622 | 52541 | SR. GUARNIZIONI | SHB 16 | VESPA e altri |
| 11623 | 52553 | SR. GUARNIZIONI | SHBC 18 - 19 - 20 B - E | VESPA PK e APE |
| 11624 | 52555 | SR. GUARNIZIONI | SHBC 18 - 19 D | VESPA e APE |
| 11625 | 52526 | SR. GUARNIZIONI | PHBG 19 - 20 - 21 A - B | PER VARIE APPLICAZIONI |
| 11627 | 52537 | SR. GUARNIZIONI | SI 20 - SI 24 | VESPA PX PE - VESPA 125/150 ('62) -GL - SPRINT |
| 11628 | 52620 | SR. GUARNIZIONI | PHBN 16 | MBK BOOSTER - APRILIA AMICO |
| 11629 | 52622 | SR. GUARNIZIONI | PHVA 12 - 17,5 | SCOOTER |

DELLORTO

RICAMBI CARBURATORI
CARBURETORS SPARE PARTS

RIDUZIONI ISOLANTI ATTACCO CARBURATORE
INSULATING REDUCTION CONNECTION CARBURETTOR



A



B



DELLORTO

| CIF ART. | DELLORTO ART. | PER CARBURATORE FOR CARBURETOR | ESTERNO EXTERNAL Ø mm. | INTERNO INTERNAL Ø mm. | LUNGHEZZA LENGHT mm. | BATTUTA STOP | IMMAGINE PICTURE |
|--------------|---------------|--------------------------------|------------------------|------------------------|----------------------|------------------|------------------|
| 11600 | 10757 | SHA 10.. | 18 | 16 | 12 | | A |
| 11601 | 7417 | SHA 12 - SHA 13 | 18 | 16 | 14 | interna/internal | A |
| 11603 | 10146 | SHA 14 - 15 | 21 | 19 | 14 | interna/internal | A |
| 11604 | 6448 | SHA 14.. B | 20 | 18 | 14 | interna/internal | A |
| 11605 | 11362 | SHA 14 C - 14 E | 21 | 18 | 12 | esterna/external | B |
| 11607 | 10811 | SHA 15 ..C | 21 | 18 | 14 | interna/internal | A |
| 11608 | 8376 | SHBC 18-19 - PHBG AS-AD | 26 | 24 | 16 | interna/internal | A |
| 11609 | 4477 | SHBC 18-19 - PHBG AS-AD | 26 | 23 | 16 | interna/internal | A |

FASCETTE TESTA CACCIAVITE COMPLETE
SCREWDRIVER CLAMPS ASSY



ART. **11522**

Fascetta Ø mm. 34

per carburatori SHB 16 F - M - L - H

(DELL.53020 78)



ART. **11523**

Fascetta Ø mm. 37

per carburatori SHBC 19 E

(DELL.53021 78)



RICAMBI CARBURATORI
CARBURETORS SPARE PARTS

DELLORTO

STARTER AUTOMATICO
AUTOMATIC STARTER



(FILO LUNGO/LONG WIRE)

11642



(FILO CORTO/SHORT WIRE)

11643

DISPOSITIVO STARTER MANUALE COMPLETO
COMPLETE MANUAL STARTER



Ø mm. 8

11637

KIT MODIFICA STARTER A LEVA
MODIFIED LEVER STARTER COVER KIT



Ø mm. 7

11638



Ø mm. 7

11639



DELLORTO

| CIF ART. | DELLORTO ART. | DESCRIZIONE DESCRIPTION | PER CARBURATORE FOR CARBURETOR | APPLICAZIONI APPLICATIONS |
|--------------|---------------|--|-----------------------------------|---|
| 11637 | 09538 64 | DISPOSITIVO STARTER BARILOTTO Ø mm.8 COMPLETE MANUAL STARTER AIR PAWL Ø mm.8 | PHBG TUTTI I TIPI ALL TYPES | |
| 11638 | 53015 78 | KIT MODIFICA STARTER A LEVA BARILOTTO Ø mm.7 MODIFIED LEVER STARTER COVER AIR PAWL Ø mm.7 | PHVA | SCOOTER |
| 11639 | 08366 64 | DISPOSITIVO STARTER BARILOTTO Ø mm.7 COMPLETE MANUAL STARTER AIR PAWL Ø mm.7 | PHBN 17,5 - SHBC 19 | |
| 11642 | 53078 | STARTER automatico (FILO LUNGO) Automatic STARTER (LONG WIRE) | PHVA PHBN | SCOOTER PIAGGIO SCOOTER APRILIA |
| 11643 | 53081 | STARTER automatico (FILO CORTO) Automatic STARTER (SHORT WIRE) | PHVA - PHBN | SCOOTER TUTTI I MOTORI ALL ENGINE MINARELLI-MORINI |

DELLORTO

RICAMBI CARBURATORI
CARBURETORS SPARE PARTS

KIT MODIFICA STARTER A FILO
MODIFIED THREAD-STARTER KIT



sostituisce lo starter
manuale sul carburatore
replace manual starter
on carburettor

11636



sostituisce lo starter manuale
sul carburatore
restore carburettor from
electric starter to manual starter

11641-V



riabilita il carburatore da
starter elettrico a manuale a filo
restore carburettor from electric
starter to manual starter

11640-CU

KIT COPERCHIO STARTER A FILO
THREAD-STARTER COVER KIT



11641

KIT CURVA GUIDAFILO
CURVE THREAD GUIDE KIT



11630-CU



11630-70



11630-90

COMANDI STARTER
STARTER



10262-A



10262-L



| CIF ART. | DESCRIZIONE / DESCRIPTION | PER CARBURATORI |
|-----------------|---|--------------------|
| 10262-A | Comando starter anulare al manubrio / ring control starter to handlebar SCOOTER E MOTO | |
| 10262-L | KIT starter a leva per fissaggio su carter motore (completo di fascetta di fissaggio) SCOOTER E MOTO KIT starter lever for fixing on carter (with clamp for fix) | |
| 11630-CU | KIT curva guidafile gas al carburatore (N.4 pz./pcs) CIAO - CIAO PX Curve thread guide kit from throttle to carburettor | |
| 11630-70 | KIT curva guidafile 70° / curve thread guide kit (curve 70°+60°) | PHBG |
| 11630-90 | KIT curva guidafile 90° / curve thread guide KIT | PHBG |
| 11636 | KIT modifica starter a filo - barilotto aria / air pawl Ø mm. 8 - SCOOTER | PHBG |
| 11640-CU | KIT modifica starter a filo - barilotto aria / air pawl Ø mm. 7 - SCOOTER | PHVA - PHBN - PHVB |
| 11641 | KIT coperchio starter a filo - barilotto aria / air pawl Ø mm. 7 (CURVA A / CURVE TO 90°+70°) | PHBN 12-14-16-17,5 |
| 11641-V | KIT starter a filo - barilotto aria / air pawl Ø mm. 7 - uscita verticale /vertical out - SCOOTER | PHBN 17,5-SHBC |



RUBINETTI BENZINA

FUEL COCKS



ART. **3170**
RUBINETTO BENZINA
Ø mm.10x1 - CODULO Ø mm. 6
CON RISERVA

FUEL COCK
Ø mm. 10x1 - SHANK Ø mm. 6
WITH RESERVE

RIZZATO - MALAGUTI e vari



ART. **3172**
RUBINETTO BENZINA
Ø mm.12x1 - CODULO Ø mm. 6
CON RISERVA

FUEL COCK
Ø mm. 12x1 - SHANK Ø mm. 6
WITH RESERVE

GARELLI VIP-FLEX e vari



ART. **3174**
RUBINETTO BENZINA
Ø mm.12x1 - CODULO Ø mm. 6
CON RISERVA

FUEL COCK Ø mm. 12x1 - SHANK Ø mm. 6
WITH RESERVE

GARELLI " NOI " e vari



ART. **9223**
MISURINO TIPO LUNGO
CON SCALA GRADUATA (120 cc.)
PER OLIO MISCELA

CUP LONG TYPE
WITH GRADUATED LEVEL (120cc.)
FOR OIL MIXTURE

ART. **9225**
MISURINO
CENTRILITATO
PER MISCELA
(100 cc.)

CUP FOR MIXTURE
(100 cc)
ORIGINAL MODEL

(Sim. 85058)



TUBI BENZINA e RICAMBI

FUEL TUBES AND SPARE PARTS



ART. **3050** MICROFILTRO BENZINA / FUEL SMALL FILTER
 CODOLO / SHANK \varnothing **mm.6**
 CICLOMOTORI E SCOOTER

ART. **3051** MICROFILTRO BENZINA / FUEL SMALL FILTER
 CODOLO / SHANK \varnothing **mm.8**
 CICLOMOTORI - SCOOTER - MOTO

ART. **3053** FILTRO BENZINA \varnothing CODOLO **VARIABILE** (A TAGLIO)
 FUEL FILTER, \varnothing SHANK **VARIABLE**
 SCOOTER - MOTO - AUTO



ART. **10123** TUBETTO OLIO PER MISCELATORE (conf. mt. 5)
 \varnothing INTERNO / INTERNAL **mm. 2 x 3,5**
 CICLOMOTORI e SCOOTER
 e lava cristallo AUTO

ART. **10124** TUBETTO (conf. mt. 5)
 \varnothing INTERNO / INTERNAL **mm. 3 x 5**
 PER SFIATI, CODOLI DEPRESSORI, etc. ...

TUBO BENZINA FUEL TUBE



ART. **10120** \varnothing INTERNO / INTERNAL **mm. 4 x 7** (conf. mt. 5)

ART. **10125** \varnothing INTERNO / INTERNAL **mm. 5 x 9** (conf. mt. 5)

ART. **10121** \varnothing INTERNO / INTERNAL **mm. 6 x 11** (conf. mt. 5)

ART. **10122** \varnothing INTERNO / INTERNAL **mm. 7 x 12** (conf. mt. 5)

TUBO BENZINA E OLIO RIVESTITO IN TRECCIA TESSILE FUEL / OIL TUBE IN TEXTILE BRAID



ART. **10117** \varnothing **mm. 3 x 7** (conf. mt. 3)

ART. **10118** \varnothing **mm. 5 x 10** (conf. mt. 3)

ART. **10119** \varnothing **mm. 6 x 13** (conf. mt. 3)

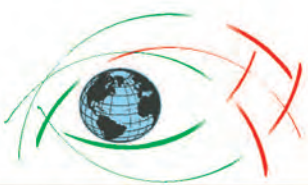

MOLLETTE - FASCETTE

FUEL TUBES SPRINGS - CLAMPS

MOLLETTE STRINGI TUBO BENZINA

GALVANIZED SPRING



| | |
|---------------------|----------|
| ART. 3040-07 | Ø mm. 7 |
| ART. 3040-09 | Ø mm. 9 |
| ART. 3040-12 | Ø mm. 12 |
| ART. 3040-14 | Ø mm. 14 |

COLLARINI PER TUBO BENZINA

FUEL TUBE COLLARS



| | |
|---------------------|------------------------------|
| ART. 3030-10 | Ø UTILIZZO / USE mm. 8 - 10 |
| ART. 3030-12 | Ø UTILIZZO / USE mm. 10 - 12 |
| ART. 3030-14 | Ø UTILIZZO / USE mm. 12 - 14 |

FASCETTE IN NYLON MILLE USI

NYLON CLAMPS



| | |
|------------------|--------------------------------|
| ART. 3060 | nera - lunghezza mm. 140 x 3,6 |
| ART. 3062 | nera - lunghezza mm. 200 x 4,8 |

FASCETTE "VINTAGE" METALLICA A COPPIGLIA

PER MANICOTTI E APPLICAZIONI VARIE

METAL BAND "VINTAGE" COTTER PIN FOR SLEEVES,
VARIOUS APPLICATIONS



| | |
|------------------|------------------------------------|
| ART. 3058 | larghezza mm. 5 - lunghezza mm.200 |
| ART. 3059 | larghezza mm. 5 - lunghezza mm.300 |

FASCETTE IN ACCIAIO INOX BANDA mm. 9

CLAMPS IN INOX STEEL



| | |
|---------------------|------------------------------|
| ART. 3020-25 | Ø UTILIZZO / USE mm. 15 - 25 |
| ART. 3020-35 | Ø UTILIZZO / USE mm. 23 - 35 |
| ART. 3020-50 | Ø UTILIZZO / USE mm. 32 - 50 |
| ART. 3020-70 | Ø UTILIZZO / USE mm. 50 - 70 |

PASSACAVO IN ACCIAIO INOX+GOMMA ANTIVIBRANTE

PASS CABLE IN INOX STEEL + ANTI VIBRATION RUBBER



| | |
|---------------------|-------------------------|
| ART. 3035-08 | Ø UTILIZZO / USE mm. 8 |
| ART. 3035-12 | Ø UTILIZZO / USE mm. 12 |
| ART. 3035-16 | Ø UTILIZZO / USE mm. 16 |
| ART. 3035-20 | Ø UTILIZZO / USE mm. 20 |

SILENTBLOCK

EXHAUST SILENTBLOCK

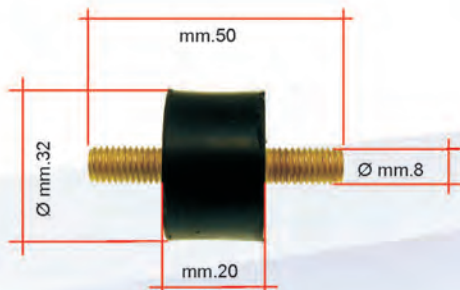

ART. **6078**

SILENTBLOCK SUPPORTO MARMITTA
DOPPIO PERNO Ø mm.8

SILENTBLOCK FOR EXHAUST, DOUBLE PIN Ø mm.8

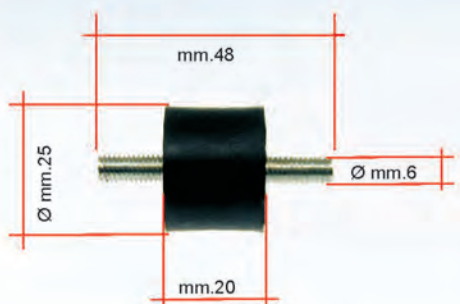

ART. **6079**

SILENTBLOCK SUPPORTO MARMITTA
DOPPIO PERNO Ø mm.6

SILENTBLOCK FOR EXHAUST, DOUBLE PIN Ø mm.6

COPPIA APPOGGIAPIEDI

STANDING PAIR



ART. **3273**

TIPO EXPORT CON STAFFA
EXPORT TYPE WITH BRACKET
CICLOMOTORI / MOPEDS

ART. **3272**

CON STAFFA
WITH BRACKET
CICLOMOTORI / MOPEDS



ART. **3271**

CON STAFFA
WITH BRACKET
MOTO / MOTORCYCLES

ART. **3274**

TIPO INCLINATO
CON VITE M10
INCLINED TYPE, WITH BOLT M10
MOTO / MOTORCYCLES



ART. **3270**

CON VITE M10
WITH BOLT M10
MOTO / MOTORCYCLES

ART. **3276**

TIPO INCLINATO
CON VITE M10
INCLINED TYPE,
WITH BOLT M10
CICLOMOTORE / MOPEDS





ALBERI MOTORE
CRANKSHAFTS



mazzucchelli

CICLOMOTORI - SCOOTER

| | | | |
|---|---|--|--|
|  mazzucchelli AMT 002 <i>Original</i> SPINOTTO / PIN Ø mm. 10 5183 |  mazzucchelli AMT 004 <i>Racing</i> SPINOTTO / PIN Ø mm. 10 5184 |  mazzucchelli AMT 118 <i>Original</i> SPINOTTO / PIN Ø mm. 12 5179 |  mazzucchelli AMT 156 <i>Racing</i> SPINOTTO / PIN Ø mm. 12 5181 |
|  mazzucchelli AMT 052-A <i>Original</i> M10x1,25 M12x1,25 5174 |  mazzucchelli AMT 074 10148 |  mazzucchelli AMT 236-A Ø mm.72 10144-A10 | |
|  mazzucchelli AMT 218-A <i>Original</i> SPINOTTO / PIN Ø mm. 12 10147 |  mazzucchelli AMT 218-M <i>Racing</i> SPINOTTO / PIN Ø mm. 12 10147-MM | | |



mazzucchelli

| CIF ART. | ART. | MODELLO TYPE | APPLICAZIONE APPLICATIONS |
|------------------|----------|--|---|
| 5174 | AMT052-A | ORIGINALE / ORIGINAL | MOTORI MINARELLI AM 3.4.5.6 |
| 5179 | AMT118 | ORIGINALE / ORIGINAL SPINOTTO Ø mm. 12 | CIAO - BRAVO - SI' |
| 5181 | AMT156 | ANTICIPATO / ANTICIPATED SPINOTTO Ø mm. 12 | CIAO - BRAVO - SI' |
| 5183 | AMT002 | ORIGINALE / ORIGINAL SPINOTTO Ø mm. 10 | CIAO - BRAVO - SI' |
| 5184 | AMT 004 | ANTICIPATO / ANTICIPATED SPINOTTO Ø mm. 10 | CIAO - BRAVO - SI' |
| 10147-A | AMT218-A | ARGENTATO / SILVER SPINOTTO Ø mm. 12 | PIAG: FREE-LIBERTY-NRG-NTT-QUARTZ-SFERA-VESPA ET2-ZIP GILERA: EASY MOVING-RUNNER-STALKER-STORM-TYPHOON |
| 10147-MM | AMT218-M | MASSE MAGGIORATE OVERSIZE MASSES SPINOTTO Ø mm. 12 | PIAG: FREE-LIBERTY-NRG-NTT-QUARTZ-SFERA-VESPA ET2-ZIP GILERA: EASY MOVING-RUNNER-STALKER-STORM-TYPHOON |
| 10144-A10 | AMT236-A | ARGENTATO / SILVER (corsa originale mm. 39,2) (original stroke mm. 39,2) SPINOTTO Ø mm. 10 | SCOOTER MOTORI MINARELLI-YAMAHA 50 cc. CILINDRO ORIZZONTALE HORIZONTAL CYLINDER APRILIA AMICO-SCARABEO-SR-RALLY-GULLIVER-SONYC BENELLI 491 4T-SPORT-K2 - BETA ARK-CHRONO-QUADRA TEMPO ITALJET DRAGSTER - MBK EVOLIS-FIZZ-NITRO-OVETTO-FLIPPER MALAGUTI F 10-F 12 PHANTOOM - F 15 FIRE FOX-CENTRO YESTERDAY - YAMAHA CY 50-BREEZE-AEROX- AXIS-NEOS-JOG-WHY |
| 10148 | AMT074 | interasse biella/ con-rod wheelbase mm.107 corsa/stroke mm. 58 | LAMBRETTA LI 2ª-3ª SERIE 125/150 cc. |

mazzucchelli



ALBERI MOTORE CRANKSHAFTS

VESPA 50-125-PRIMAVERA-PK 50/125... - APE 50

| | | | |
|---|--|--|--|
| <p>mazzucchelli "Original" AMT 120</p>  <p>sviluppo valvola mm.204</p> <p>cono 19 mm. 5165</p> | <p>mazzucchelli "Racing" AMT 158</p> <p>Anticipato Anticipated</p>  <p>sviluppo valvola mm.180</p> <p>cono 19 mm. 5168</p> | <p>mazzucchelli "Racing" AMT 184</p> <p>Super Competizione Super Racing</p>  <p>sviluppo valvola mm.190</p> <p>cono 19 mm. 5168-SC</p> | <p>mazzucchelli "Racing" AMT 158-DA</p> <p>Doppia Alimentazione Dual Power</p>  <p>sviluppo valvola mm.204</p> <p>cono 19 mm. 5168-DA</p> |
| <p>mazzucchelli "Original" AMT 126</p>  <p>sviluppo valvola mm.200</p> <p>cono 19 mm. 5167</p> | <p>mazzucchelli "Racing" AMT 160</p>  <p>sviluppo valvola mm.180</p> <p>cono 19 mm. 5169</p> | <p>mazzucchelli "Racing" AMT 182</p> <p>Super Competizione Super Racing</p>  <p>sviluppo valvola mm.180</p> <p>cono 19 mm. 5169-SC</p> | <p>mazzucchelli "Racing" AMT 160-DA</p> <p>Doppia Alimentazione Dual Power</p>  <p>sviluppo valvola mm.200</p> <p>cono 19 mm. 5169-DA</p> |
| <p>mazzucchelli "Racing" AMT 160-VT</p> <p>Competizione volani tondi Racing round flywheel</p>  <p>cono 19 mm. 5169-VT **</p> | <p>mazzucchelli "Original" AMT 026</p>  <p>sviluppo valvola mm.204</p> <p>cono 20 mm. 5163</p> | <p>mazzucchelli "Racing" AMT 028</p> <p>Anticipato Anticipated</p>  <p>sviluppo valvola mm.180</p> <p>cono 20 mm. 5164</p> | <p>mazzucchelli "Racing" AMT 030</p> <p>Super Competizione Super Racing</p>  <p>sviluppo valvola mm.190</p> <p>cono 20 mm. 5164-SC</p> |



mazzucchelli

| CIF ART. | ART. | MODELLO TYPE | BIELLA CON-ROD | CORSA STROKE | APPLICAZIONI APPLICATIONS |
|-------------------|-----------|--|--------------------------------|-----------------|---|
| 5165 | AMT120 | ORIGINALE / ORIGINAL | | mm. 43 | |
| 5168 | AMT158 | ANTICIPATO / ANTICIPATED | LUCIDA/POLISHED | mm. 43 | VESPA 50 ('65-'66) VESPA 50 SPECIAL VESPA PK 50 1ª serie |
| 5168-SC | AMT184 | SUPER COMPETIZIONE INTERAMENTE LUCIDO SUPER RACING MODEL ALL POLISHED | RINFORZATA HF REINFORCED HF | mm. 43 | |
| 5168-DA | AMT158-DA | DOPPIA ALIMENTAZIONE/DUAL POWER MODEL | LUCIDA/POLISHED | mm. 43 | |
| 5167 | AMT126 | ORIGINALE / ORIGINAL | | mm. 51 | |
| 5169 | AMT160 | ANTICIPATO / ANTICIPATED | LUCIDA/POLISHED | mm. 51 | |
| 5169-SC | AMT182 | SUPER COMPETIZIONE INTERAMENTE LUCIDO SUPER RACING MODEL ALL POLISHED | RINFORZATA HF REINFORCED HF | mm. 51 | VESPA 125 PRIMAVERA ET3 VESPA PK 125 1ª serie |
| 5169-DA | AMT160-DA | DOPPIA ALIMENTAZIONE / DUAL POWER | LUCIDA/POLISHED | mm. 51 | |
| 5169-VT ** | AMT160-VT | COMPETIZIONE VOLANI TONDI RACING, ROUND FLYWHEELS | LUCIDA/POLISHED | mm. 51 | |
| 5163 | AMT026 | ORIGINALE / ORIGINAL | | mm. 43 | VESPA PK 50 XL VESPA HP VESPA RUSH VESPA FL2 |
| 5164 | AMT028 | ANTICIPATO ANTICIPATED | LUCIDA / POLISHED | mm. 43 | APE TM 50 APE 50 TL6 |
| 5164-SC | AMT030 | SUPER COMPETIZIONE INTERAMENTE LUCIDO SUPER RACING MODEL ALL POLISHED | RINFORZATA HF REINFORCED HF | mm. 43 | |

**

Per l'applicazione necessita collettore lamellare con modifica carter sull'aspirazione o aspirazione sul cilindro con conseguente chiusura del foro aspirazione sul carter.
The application needs lamellar manifold with modified crankcase on the intake or intake on cylinder with resulting the closure of the hole intake on the crankcase.



ALBERI MOTORE
CRANKSHAFTS



mazzucchelli

VESPA PK 125 XL - PX 125/150

Per l'applicazione necessita collettore lamellare con modifica carter sull'aspirazione o aspirazione sul cilindro con conseguente chiusura del foro aspirazione sul carter.
The application needs lamellar manifold with modified crankcase on the intake or intake on cylinder with resulting the closure of the hole intake on the crankcase.

| | | | |
|---|---|--|--|
| <p>mazzucchelli AMT 186</p> <p>"Racing" Anticipato Anticipated</p> <p>TRASFORMAZIONE da 50 cc. a 125 cc.</p>  <p>sviluppo valvola mm.180</p> <p>cono 20 mm.</p> <p>5162</p> | <p>mazzucchelli AMT 188</p> <p>"Racing" Super Competizione Super Racing</p> <p>TRASFORMAZIONE da 50 cc. a 125 cc.</p>  <p>sviluppo valvola mm.180</p> <p>cono 20 mm.</p> <p>5162-SC</p> | <p>mazzucchelli AMT 186-VT</p> <p>"Racing" Competizione volani tondi Racing round flywheel</p> <p>TRASFORMAZIONE da 50 cc. a 125 cc.</p>  <p>sviluppo valvola mm.180</p> <p>cono 20 mm.</p> <p>5162-VT **</p> | <p>mazzucchelli AMT 174</p> <p>"Original"</p>  <p>sviluppo valvola mm.175</p> <p>10140</p> |
| <p>mazzucchelli AMT 176</p> <p>"Racing" Anticipato Anticipated</p>  <p>sviluppo valvola mm.185</p> <p>10142</p> | <p>mazzucchelli AMT 178</p> <p>"Racing" Super Competizione Super Racing</p>  <p>sviluppo valvola mm.185</p> <p>10142-SC</p> | <p>mazzucchelli AMT 154</p> <p>"Original"</p>  <p>sviluppo valvola mm.210</p> <p>5180</p> | <p>mazzucchelli AMT 162</p> <p>"Racing" Anticipato Corsa mm.57 Anticipated Stroke mm.57</p>  <p>sviluppo valvola mm.200</p> <p>5180-A</p> |
| <p>mazzucchelli AMT 162-VT</p> <p>"Racing" Competizione volani tondi Racing round flywheel</p>  <p>Corsa mm.57 Stroke mm.57</p> <p>** 5180-VT</p> | <p>mazzucchelli AMT 162-M</p> <p>"Racing" Anticipato Corsa mm.60 Anticipated Stroke mm.60</p>  <p>sviluppo valvola mm.200</p> <p>5180-CLA</p> | <p>mazzucchelli AMT 162-MK</p> <p>"Racing" Anticipato Corsa mm.60 Anticipated Stroke mm.60</p>  <p>sviluppo valvola mm.200</p> <p>MATERIALE K2D per SOLLECITAZIONI AGONISTICHE</p> <p>5180-CLK</p> | <p>mazzucchelli AMT 162-MVT</p> <p>"Racing" Competizione volani tondi Racing round flywheel</p>  <p>Corsa mm.60 Stroke mm.60</p> <p>** 5180-CLVT</p> |



mazzucchelli

| CIF ART. | ART. | MODELLO TYPE | BIELLA CON-ROD | CORSA STROKE | APPLICAZIONI APPLICATIONS |
|---------------------|------------|---|-----------------------------|---------------|---|
| 5162 | AMT186 | ANTICIPATO / ANTICIPATED | LUCIDA/POLISHED | mm. 51 | PER TRASFORMAZIONE DA 50 cc. a 125 cc. FOR TRANSFORMATION FROM 50 cc. TO 125 cc. |
| 5162-SC | AMT188 | SUPER COMPETIZIONE SUPER RACING MODEL | RINFORZATA HF REINFORCED HF | mm. 51 | |
| 5162-VT ** | AMT186-VT | COMPETIZIONE VOLANI TONDI RACING MODEL, ROUND FLYWHEELS | RINFORZATA HF REINFORCED HF | mm. 51 | |
| 10140 | AMT174 | ORIGINALE / ORIGINAL | | mm. 51 | VESPA PK 125 XL |
| 10142 | AMT176 | ANTICIPATO / ANTICIPATED | LUCIDA/POLISHED | mm. 51 | |
| 10142-SC | AMT178 | SUPER COMPETIZIONE INTERAMENTE LUCIDO SUPER RACING MODEL ALL POLISHED - | RINFORZATA HF REINFORCED HF | mm. 51 | |
| 5180 | AMT154 | ORIGINALE / ORIGINAL CORSA ORIGINALE | | mm. 57 | VESPA PX 125 / 150 cc. |
| 5180-A | AMT162 | ANTICIPATO/ANTICIPATED CORSA ORIGINALE | LUCIDA/POLISHED | mm. 57 | |
| 5180-VT ** | AMT162-VT | COMPETIZIONE VOLANI TONDI RACING,ROUND FLYWHEELS CORSA ORIGINALE | LUCIDA/POLISHED | mm. 57 | |
| 5180-CLA | AMT162-M | ANTICIPATO / ANTICIPATED CORSA LUNGA | LUCIDA/POLISHED | mm. 60 | |
| 5180-CLK | AMT162-MK | ANTICIPATO / ANTICIPATED CORSA LUNGA | LUCIDA/POLISHED | mm. 60 | |
| 5180-CLVT ** | AMT162-MVT | COMPETIZIONE VOLANI TONDI RACING, ROUND FLYWHEELS CORSA LUNGA | LUCIDA/POLISHED | mm. 60 | |

mazzucchelli "Original"
AMT 164
sviluppo valvola mm.210

5178

mazzucchelli "Racing"
AMT 166
sviluppo valvola mm.200
Anticipato
Corsa mm.57
Anticipated
Stroke mm.57

5178-A

mazzucchelli "Racing"
AMT 166-M
sviluppo valvola mm.200
Anticipato
Corsa mm.60
Anticipated
Stroke mm.60

5178-CLA

mazzucchelli "Racing"
AMT 168/60
sviluppo valvola mm.200
Anticipato
Corsa mm.60
Anticipated
Stroke mm.60
REALIZZATO IN MATERIALE K2D
PER SOLLECITAZIONI AGONISTICHE

5178-CLKP

mazzucchelli "Racing"
AMT 166-MVT
sviluppo valvola mm.200
Competizione volani tondi
Corsa mm.60
Racing round flywheel
Stroke mm.60

**** 5178-CLVT**

mazzucchelli "Original"
AMT 134
sviluppo valvola mm.215

5171

mazzucchelli "Original"
AMT 132
sviluppo valvola mm.215

5176

mazzucchelli "Racing"
AMT 133
sviluppo valvola mm.215
MODIFICA ACCENSIONE ELETTRONICA
MODIFY ELECTRONIC IGNITION

5176-AE

mazzucchelli "Racing"
AMT 135
sviluppo valvola mm.205
MODIFICA ACCENSIONE ELETTRONICA
MODIFY ELECTRONIC IGNITION

5176-AER

| CIF ART. | ART. | MODELLO TYPE | BIELLA CON-ROD | CORSA STROKE | APPLICAZIONI APPLICATIONS |
|-------------------------------|------------|---|-----------------|---------------|---|
| 5171 | AMT134 | ORIGINALE / ORIGINAL | | | VESPA RALLY 200 |
| 5176 | AMT132 | ORIGINALE / ORIGINAL | | mm. 57 | VESPA SUPER - SPRINT |
| 5176-AE | AMT133 | VERSIONE NORMALE (tipo V.PX CONO Ø mm.20) MODIFICA ACCENSIONE ELETTRONICA MODIFY ELECTRONIC IGNITION | | mm. 57 | ADATTABILE/SUITABLE: VESPA 125 (VNB1->6T) VESPA GT - GTR 125 VESPA TS 125 VESPA 150 (VBA-VBB) VESPA GL 150 |
| 5176-AER | AMT135 | VERSIONE RACE (tipo V.PX CONO Ø mm.20) MODIFICA ACCENSIONE ELETTRONICA MODIFY ELECTRONIC IGNITION | LUCIDA/POLISHED | mm. 57 | |
| 5178 | AMT164 | ORIGINALE / ORIGINAL CORSA ORIGINALE / ORIGINAL STROKE | | mm. 57 | |
| 5178-A | AMT166 | ANTICIPATO / ANTICIPATED CORSA ORIGINALE / ORIGINAL STROKE | LUCIDA/POLISHED | mm. 57 | |
| 5178-CLA | AMT166-M | ANTICIPATO / ANTICIPATED CORSA LUNGA / LONG STROKE | LUCIDA/POLISHED | mm. 60 | |
| 5178-CLKP | AMT168/60 | ANTICIPATO / ANTICIPATED CORSA LUNGA / LONG STROKE REALIZZATO IN MATERIALE K2D PER SOLLECITAZIONI AGONISTICHE | LUCIDA/POLISHED | mm. 60 | VESPA PE 200 |
| 5178-CLVT ** | AMT166-MTV | COMPETIZIONE VOLANI TONDI RACING, ROUND FLYWHEELS CORSA LUNGA / LONG STROKE | LUCIDA/POLISHED | mm. 60 | |



ALBERI MOTORE CRANKSHAFTS

VESPA 125/150 OLD MODELS - 180 SS - GS 150/160

Made In Italy "Original"



BIELLA / CON-ROD **mm. 110**
CORSA / STROKE **mm. 54**

5194-110

Made In Italy "Original"



BIELLA / CON-ROD **mm. 110**
CORSA / STROKE **mm. 57**

5195-110

Made In Italy "Original"



5196

Made In Italy "Original"



BIELLA / CON-ROD **mm. 105**
CORSA / STROKE **mm. 54**

5194-105

Made In Italy "Original"



BIELLA / CON-ROD **mm. 105**
CORSA / STROKE **mm. 57**

5195-105

Made In Italy "Original"



5197

Made In Italy "Original"



5198

Made In Italy "Original"



5199



| CIF ART. | MODELLO TYPE | BIELLA CON-ROD | CORSA STROKE | APPLICAZIONI APPLICATIONS |
|-----------------|----------------------|-------------------|-----------------|---|
| 5194-105 | ORIGINALE / ORIGINAL | mm. 105 | mm. 54 | VESPA 125 (VNA1T-VNA2T) ('57-'58) |
| 5194-110 | ORIGINALE / ORIGINAL | mm. 110 | mm. 54 | VESPA 125 (VN1/VN2-VM1/VM2) ADATTABILE A/SUITABLE TO: ACMA PARIS 125 ('51-'55) |
| 5195-105 | ORIGINALE / ORIGINAL | mm. 105 | mm. 57 | |
| 5195-110 | ORIGINALE / ORIGINAL | mm. 110 | mm. 57 | VESPA 150 (VL1-2-3T) VESPA 150 VB1T ('57-'58) |
| 5196 | ORIGINALE / ORIGINAL | | | VESPA 125 (DAL V30 AL V33) ('51-'52) |
| 5197 | ORIGINALE / ORIGINAL | | | VESPA 180 SS |
| 5198 | ORIGINALE / ORIGINAL | | | VESPA GS 150 (VS 1-2-3-4-5) ('55-'61) |
| 5199 | ORIGINALE / ORIGINAL | | | VESPA GS 160 (VSB1T) ('62-'65) |

TABELLA IN ORDINE CRESCENTE IN BASE AL Ø INTERNO / LIST IN ORDER OF INTERNAL Ø

| DIMENSIONI Ø int. est. h | Rif.Orig. | CIF ART. | Applicazioni Applications | |
|-----------------------------|------------------|----------------|---|--|
| 8 16 10/11 | 435203.5 | 5935 | per girante pompa acqua / for h20 pump rotor SCOOTER PIAGGIO-GILERA 50/125/150/180 cc. | CORTECO  |
| 10 18 4 | 152351 | 5932 | per girante pompa acqua / for h20 pump rotor Scooter motori MINARELLI-YAMAHA 50 cc. per coperchio frizione / for clutch cover : VESPA 50/125 FL-50 HP APE MP 501-P601-220 (1978-1976) | CORTECO  |
| 13 19 3 | 008766 | 5954 | Parapolvere campana frizione variatore variator clutch drum PIAGGIO CIAO - BRAVO - Si CON VARIATORE / WITH VARIATOR | NAK  |
| 13 22 4 | 240222 | 5955 | coperchio mozzo posteriore variatore rear hub cover PIAGGIO CIAO - BRAVO - Si CON VARIATORE / WITH VARIATOR | ROLF  |
| 15 24 5 | 480464 112978 | 5900 | lato volano / flywheel side PIAGGIO CIAO - BRAVO - Si | CORTECO  |
| 15,6 25,5 7 RP | | 5929 | lato frizione / clutch side : PEUGEOT 50 cc. BUXI-ELYSEO-SQUAB-SV GEO- TREKKER-..... lato volano e frizione / flywheel and clutch side PEUGEOT FOX | CORTECO  |
| 16 22 3 | 124571 8769 | 5901 | Parapolvere per puleggia motrice driving pulley PIAGGIO CIAO - BRAVO - Si SENZA VARIATORE / WITHOUT VARIATOR | ROLF  |
| 16 30 4,5 | 037616 | 5931 | lato volano / flywheel side MOTORI PEUGEOT 100 cc. ELYSEO 100 - SV 100 - VIVACITY 100 TREKKER 100 | CORTECO  |
| 17 25 4 | 114469 | 5903 | coperchio mozzo posteriore rear hub cover PIAGGIO CIAO - BRAVO - Si SENZA VARIATORE / WITHOUT VARIATOR | CORTECO  |
| 17 26 6 Vm | | 5920-V | in VITON MARRONE / BROWN VITON lato volano / flywheel side MOTORI MORINI DITECH H20 2000 APRILIA SR 2000-ITALJ.FORMULA-SUZUKI KATANA | CORTECO   |
| 17 28 5 | | 5924 | motori MINARELLI-YAMAHA SCOOTER: APRILIA-MALAGUTI-MBK | ROLF  |
| 17 28 7 RHTC-ACM | 969028 | 5940-AN | lato volano / flywheel side motori PIAGGIO 50 cc. 4 TEMPI/STROKE versione anno 2000-2004 motori CHIN del 2006 | CORTECO   |
| 17 35 7 RP | YA.F173580 | 5927-C | lato volano / flywheel side motori MINARELLI 6 Vel./speed APRILIA RS 50 ('97) - PEUGEOT XP6 50 YAMAHA TZR - DTR 50 - MBK XLIMIT-POWER | CORTECO  |



ANELLI DI TENUTA

OIL SEALS



TABELLA IN ORDINE CRESCENTE IN BASE AL Ø INTERNO / LIST IN ORDER OF INTERNAL Ø

| DIMENSIONI Ø int. est. h | Rif.Orig. | CIF ART. | Applicazioni Applications | |
|-----------------------------|------------------|---------------|--|---|
| 17 40 7 | 008722 | 5946 | ruota anteriore / front wheel VESPA 50 - 90 - 1ª sr.- RALLY - GT SPRINT - TS - SUPER | CORTECO  |
| 18 24 4 | 008771 | 5902 | parapolvere campana frizione variatore variator clutch drum CIAO - BRAVO - SI' variatore | CORTECO  |
| 18 28 7 RP | 286359 | 5936 | doppio labbro / double lips lato volano / flywheel side SCOOTER PIAGGIO - GILERA | ROLF  |
| 18 28 7/7,5 RP Vm | 482315 | 5936-V | doppio labbro / double lips VITON MARRONE / BROWN VITON lato volano / flywheel side SCOOTER PIAGGIO - GILERA | CORTECO  Viton |
| 18 35 8 NBR | | 5961 | lato frizione-lato volano / clutch-flywheel side VESPA 98 ('46-'47) VESPA 125 ('48-'52) FARO BASSO | ROLF  |
| 19 30 7 RP | | 5937 | doppio labbro / double lips lato frizione / clutch side SCOOTER PIAGGIO - GILERA 50 cc. 2T | ROLF  |
| 19 30 6,5 RP Vm | 482314 | 5937-V | doppio labbro in VITON MARRONE double lips in BROWN VITON lato frizione / clutch side SCOOTER PIAGGIO - GILERA 50 cc. 2T | CORTECO  Viton |
| 19 32 7 | 430390 155579 | 5904 | lato volano / flywheel side VESPA 50 - 90 - PRIMAVERA - ET3 VESPA PK 50 APE 50 | CORTECO  |
| 19 32 7 Vm | | 5904-V | lato volano / flywheel side VITON MARRONE / BROWN VITON VESPA 50 - 90 - PRIMAVERA - ET3 VESPA PK 50 + APE 50 | CORTECO  Viton |
| 20 30 5 | 131511 | 5905 | coperchio mozzo posteriore rear hub cover PIAGGIO CIAO - BRAVO - SI | CORTECO  |
| 20 30 5/6.1RP | | 5925 | doppio labbro / double lips lato volano / flywheel side SCOOTER motori MINARELLI-YAMAHA APRILIA-MALAGUTI-MBK | CORTECO  |
| 20 30 7 RP | | 5930 | lato volano / flywheel side : PEUGEOT 50 cc. BUXI-ELYSEO-SQUAB-GEO-TREKKER-ZENITH lato volano-frizione/flywheel-clutch side LUDIX 50 lato frizione / clutch side: PEUGEOT 100 cc. ELYSEO-SV-VIVACITY-TREKKER | CORTECO  |
| 20 32 7 RP | 289306 17016 | 5965-C | con labbro parapolvere lato volano / flywheel side VESPA PK 50 XL - PK FL APE 50 FL2 | CORTECO  |

TABELLA IN ORDINE CRESCENTE IN BASE AL Ø INTERNO / LIST IN ORDER OF INTERNAL Ø

| DIMENSIONI Ø int. est. h | Rif.Orig. | CIF ART. | Applicazioni Applications | |
|-----------------------------|-----------|----------------|---|---|
| 20 32 7 FPM RP Vm | 430392 | 5965-V | in VITON MARRONE con labbro parapolvere lato volano BROWN VITON - flywheel side VESPA PK 50 XL - PK FL2 - APE 50 FI2 | CORTECO   |
| 20 35 7/7,5 | | 5962 | lato volano - flywheel side DERBI 6 VELOCITA' / SPEED |  |
| 20 35 7 NBR | | 5962-C | lato frizione / clutch side PER CARTER MODIFICATO QUATTRINI VESPA 50 - 90 - 125 PRIMAVERA - ET3 VESPA PK 50 - PK 50 XL | CORTECO  |
| 20 42/43 8/9 RP | | 5926 | doppio labbro - lato frizione double lips - clutch side SCOOTER motori MINARELLI-YAMAHA APRILIA - MALAGUTI - MBK | CORTECO  |
| 20 40 6 FG | 025180 | 5947 | flangiato tacca tonda - lato volano tick round - flywheel side VESPA SPRINT - SPRINT VELOCE VESPA GT - GTR - VESPA SUPER VESPA GL 150 - GS 150 (VS1-2-3-4-5T) | ROLF  |
| 20 40 6 FG | 084644 | 5947-AC | flangiato tacca quadrata / tick square lato volano / flywheel side: VESPA SPRINT - SUPER - GTR - TS GL 150 lato frizione-volano / clutch and flywheel side : VESPA 125/150 - GS 150 | CORTECO  |
| 20 40 6 FG | 084644 | 5947-AR | flangiato tacca quadrata / tick square lato volano / flywheel side: VESPA SPRINT - SUPER - GTR - TS GL 150 lato frizione-volano / clutch and flywheel side : VESPA 125/150 - GS 150 | ROLF  |
| 20 62 6,5 | 49290 | 5949-C | lato frizione / clutch side VESPA SPRINT 150 - SPRINT VELOCE VESPA GT - GTR - SUPER - GL 150 - 125 TS VESPA 125/150 | CORTECO  |
| 20 62 6,5 | 49290 | 5949-R | lato frizione / clutch side VESPA SPRINT 150 - SPRINT VELOCE VESPA GT - GTR - SUPER - GL 150 - 125 TS VESPA 125/150 | ROLF  |



ANELLI DI TENUTA

OIL SEALS



TABELLA IN ORDINE CRESCENTE IN BASE AL Ø INTERNO / LIST IN ORDER OF INTERNAL Ø

| DIMENSIONI Ø int. est. h | Rif.Orig. | CIF ART. | Applicazioni Applications | |
|-----------------------------|------------------|----------|--|--|
| 22 32 6 RP | | 5923 | doppio labbro / double lips asse ruota posteriore / rear wheel axle SCOOTER motori MINARELLI-YAMAHA APRILIA - MALAGUTI - MBK ADATTABILE/SUITABLE : lato frizione / clutch side mot.PIAGGIO 50/100/125 cc.4 TEMPI/STROKE HEXAGON LX4 - FLY - LIBERTY - SFERA VESPA ET4-VESPA LX 4T - ZIP 4T | CORTECO  |
| 22 32 7/9 | 431044 | 5919-C | con labbro parapolvere cuffia semiasse / axle shaft oil seal hood APE MP 501-P601 220 ('78-'96)-CAR P2-P3 220 ('78-'85)-APE TM 602 220 ('82-'83) APE TM P703-P703V-FL2 220 ('84-'85) | CORTECO  |
| 22 40 7 RSX Vm | 239848 | 5939-V | VITON MARRONE / BROWN VITON per albero puleggia condotta for driven pulley shaft SCOOTER PIAGGIO-GILERA | CORTECO  Viton |
| 22,7 47 7 | 289305 8731 | 5906 | lato frizione / clutch side VESPA 50 - 90 - PRIMAVERA - ET3 VESPA PK 50/125 - PK 50/125 XL - FL APE 50 | CORTECO  |
| 22,7 47 7 Vm | 430391 | 5906-V | VITON MARRONE / BROWN VITON lato frizione / clutch side VESPA 50 - 90 - PRIMAVERA - Et3 VESPA PK 50/125 - PK 50/125 XL - FL APE 50 | CORTECO  Viton |
| 24 32 7 NRB | | 5899-C | lamiera esterna lato volano / flywheel side x modifica: si utilizza x installare albero motore PK 125 c/cono grosso SU : VESPA 50 - 90 - PRIMAVERA - ET3 VESPA PK 50 - PK 50 XL | CORTECO  |
| 24 35 6 | 431121 158962 | 5907 | lato volano / flywheel side VESPA PX 125 /150 VESPA PX 125/150/200 ARCOBALENO VESPA 125 T5 - PK 125 - PK 125 XL | ROLF  |
| 24 35 6 R | 431121 158962 | 5907-C | lato volano / flywheel side VESPA PX 125 /150 VESPA PX 125/150/200 ARCOBALENO VESPA 125 T5 - PK 125 - PK 125 XL | CORTECO  |
| 24 35 7 Vm | 434582 | 5941-AN | VITON MARRONE / BROWN VITON lato frizione-volano / clutch-flywheel side motori PIAGGIO-GILERA 125/150/180 cc. 2T HEXAGON LX-LX-HEXAGON -SKIPPER-LX 125/150 TYPHOON X-XR -TYPHOON-RUNNER FX-FXR lato frizione / clutch side: MINARELLI 6 VEL./SPEED | CORTECO  Viton |
| 24 40 7 | 008708 | 5943 | ruota anteriore / front wheel VESPA 50 - 90 - 125 PRIMAVERA - Et3 | CORTECO  |

TABELLA IN ORDINE CRESCENTE IN BASE AL Ø INTERNO / LIST IN ORDER OF INTERNAL Ø

| DIMENSIONI Ø int. est. h | Rif.Orig. | CIF ART. | Applicazioni Applications | |
|-----------------------------|------------------|---------------|---|--|
| 24 43 6 | | 5922 | lato frizione esterno / <i>clutch external side</i> motori MORINI DITECH H20 2000 VERSIONE CARBURATORE E INIEZIONE APRILIA SR 2000 - ITALJET FORMULA SUZUKI KATANA | CORTECO  |
| 24,9 40 6,5 R Vm | 169810 | 5944-V | in VITON MARRONE / <i>BROWN VITON</i> lato volano esterno / <i>flywheel external side</i> APE 501 PRIME SERIE fino al 1982 APE TM P 602 - TM P703 - APE CAR APE MP (cambio rinforzato/ <i>reinforced gear shift</i>) | ROLF <i>Viton</i>  |
| 24,9 45 6,5 | 78002 | 5908 | lato volano esterno / <i>flywheel external side</i> APE MP P501 - P601 APE 500 - APE 600 | ROLF  |
| 24,9 45 5,5/6,5 | | 5958 | lato volano esterno / <i>flywheel external side</i> VESPA GS 160 - 180 SS | PHLE  |
| 25 37 6 Vm | | 5921-V | in VITON MARRONE / <i>BROWN VITON</i> lato frizione interno / <i>clutch internal side</i> motori MORINI DITECH H20 2000 VERSIONE CARBURATORE E INIEZIONE APRILIA SR 2000 - ITALJET FORMULA SUZUKI KATANA | CORTECO <i>Viton</i>  |
| 25 40 7 | 128217 | 5909 | ruota anteriore / <i>front wheel</i> VESPA 50 - 90 - 125 - PRIMAVERA - ET3 VESPA PK 50 carter differenziale / <i>differential housing</i> APE 50 F12 | CORTECO  |
| 25,7 35 7/9 | 269888 123196 | 5968 | forcella / <i>fork PIAGGIO:</i> ZIP 50 ('92-'93) - ZIP BIMODALE 50 ('94-'97) ZIP F.RAIDER 50 ('93-'94)-ZIP Freno a Disco SI' 50 (79-88)-SI' FL2 50(91-97)-SI' MIX 50 (96-99) BRAVO'82 - SUPERBRAVO 50 GILERA: EASY MOVING 50 | CORTECO  |
| 26 42 7 | | 5951 | asse ruota posteriore / <i>rear wheel axle</i> PEUGEOT BUXI | CORTECO  |
| 27 37 7 | 46699 | 5910 | ruota posteriore / <i>rear wheel</i> VESPA 50 - 90 - 125 - PRIMAVERA - ET3 VESPA PK 50/125 - PK 50/125 XL - FL | CORTECO  |
| 27 37 7 | 46699 | 5910-R | ORIGINALE DI 1 ^a EQUIPAGGIAMENTO ruota posteriore / <i>rear wheel</i> VESPA 50 - 90 - 125 - PRIMAVERA - ET3 VESPA PK 50/125 - PK 50/125 XL - FL | ROLF  |
| 27 42 10 | 118058 | 5957 | ruota posteriore / <i>rear wheel</i> VESPA 125/150 - GS 150 - 125 T5 VESPA COSA APE 50 - TM 50 - P50 | CORTECO  |



ANELLI DI TENUTA

OIL SEALS



TABELLA IN ORDINE CRESCENTE IN BASE AL Ø INTERNO / LIST IN ORDER OF INTERNAL Ø

| DIMENSIONI Ø | | | Rif.Orig. | CIF ART. | Applicazioni Applications | |
|--------------|------|------------|-----------------|----------------|--|---|
| int. | est. | h | | | | |
| 27 | 47 | 6 | 130536 | 5911 | ruota posteriore / rear wheel VESPA PX 125-150 - PX ARCOBALENO VESPA RALLY 200- SPRINT - SPRINT VELOCE VESPA GT - GTR - SUPER GL 150 | ROLF  |
| 27 | 47 | 6 | 130536 | 5911-C | ruota posteriore / rear wheel VESPA PX 125-150 - PX ARCOBALENO VESPA RALLY 200- SPRINT - SPRINT VELOCE GT - GTR - SUPER GL 150 | CORTECO  |
| 28 | 40 | 7 | 116205 17014 | 5956 | carter differenziale / differential crankcase APE 50 | CORTECO  |
| 30 | 40 | 7 | | 5953 | asse ruota posteriore / rear wheel axle VESPA GS 160 | CORTECO  |
| 30 | 47 | 6 | 478498 8714 | 5950 | asse ruota posteriore / rear wheel axle SCOOTER PIAGGIO - GILERA VESPA PE 200 ARCOBALENO | CORTECO  |
| 31 | 62,5 | 6 | 131102 | 5912 | tutto gomma / all rubber lato frizione / clutch side VESPA PX PE 125-150-200 VESPA PX PE ARCOBALENO 125-150-200 VESPA 125 T5 - RALLY 180-200 | ROLF  |
| 31 | 62 | 5,8/4,3 | 131102 | 5912-C | lato frizione / clutch side VESPA PX PE 125-150-200 VESPA PX PE ARCOBALENO 125-150-200 VESPA 125 T5 - RALLY 180-200 | CORTECO  |
| 31 | 62,1 | 5,8/4,3 | 242549 | 5912-L | (lamiera esterna / sheet metal external) lato frizione / clutch side VESPA PX PE 125-150-200 VESPA PX PE ARCOBALENO 125-150-200 VESPA 125 T5 - RALLY 180-200 | CORTECO  |
| 31 | 62,1 | 5,8/4,3 Vm | 242550 | 5912-LV | interno / internal VITON MARRONE / BROWN (lamiera esterna / sheet metal external) lato frizione / clutch side VESPA PX PE 125-150-200 VESPA PX PE ARCOBALENO 125-150-200 VESPA 125 T5 - RALLY 180-200 | CORTECO  |

TABELLA IN ORDINE CRESCENTE IN BASE AL Ø INTERNO / LIST IN ORDER OF INTERNAL Ø

| DIMENSIONI Ø int. est. h | Rif.Orig. | CIF ART. | Applicazioni Applications | |
|---|-------------|---------------|--|--|
| 32 45 5 Vm | 221438 | 5960-V | VITON MARRONE / BROWN VITON lato volano interno / internal flywheel side APE MP P501 DAL / SINCE 1982 --> | ROLF  |
| 32 52 5 | 77976 | 5913 | lato volano interno / flywheel internal VESPA GS 160 - 180 SS APE MP P501-P601 - APE 500 - APE 600 | ROLF  |
| 32 57/61 6 NBR-SEZ.SC5 | | 5959 | lato frizione / clutch side VESPA GS 160 - 180 SS | PHLE  |
| 32 62 6 | 127891-8726 | 5914-V | VITON NERO / BLACK VITON lato frizione / clutch side APE MP P501-P601 - APE 500 - APE 600 | ROLF  |
| 34 62 6 Vm | 222478 | 5945-V | VITON MARRONE / BROWN VITON lato frizione / clutch side APE MP P501 DAL / SINCE 1982 --> APE TM P602-TM P703 - CAR - MP P501-P601 cambio rinforzato - reinforced gear shift | ROLF  |
| 35 47 7 | 20359 | 5918 | asse ruota posteriore / rear wheel axle APE CALESSINO (CITY) 200 ('13-'16) APE CALESSINO VME 420 ('07-'12) APE CAR P2-P3 220 ('78-'85)- CLASSIC 400 ('14-'16) -APE MP P501-P601 220 ('78-'96) -APE MP 601 CLASSIC 420 ('06-'13) QUARGO DIESEL 750 ('04-'06) | CORTECO  |
| ROLF  | 109066 | 5916 | ANELLO PARAPOLVERE PER SERIE CALOTTA STERZO DUST COVER RING FOR BEARING BALL TRACK APE MP - MPA - MPV - APE CAR | |
| ROLF  | 125223 | 5917 | ANELLO PARAPOLVERE PER SERIE CALOTTA STERZO DUST COVER RING FOR BEARING BALL TRACK APE CAR - TM P602 - TM P703 - TM DIESEL - APE MAX | |

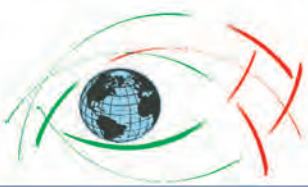

ANELLINI OR O-RINGS

ART. 7010-KT

KIT ANELLINI OR
PER SERIE PARAOLI MOTORE

VESPA 50-90-125 PRIMAVERA-ET3
VESPA PK 50/125 - PK 50/125 XL - FL



ART. 7011-KT

KIT ANELLINI OR
PER SERIE PARAOLI MOTORE

VESPA PX 125-150 - 200
VESPA PX ARCOBALENO
VESPA GL 150-SPRINT 150-RALLY 180-200



ART. 7000

ANELLO **OR 210** (15.88x2,62) (Sim. 006721)
PER SETTORE MESSA IN MOTO
VESPA 50-90-125 PRIMAVERA-ET3-PK-PX



ART. 7008

ANELLO **OR 140** (11.11x1,78) (Sim. 006714)
PER CEPPI FRENI RUOTA POSTERIORE
VESPA PX-PX ARCOBALENO-GL 150-SPRINT 150-RALLY



ART. 7001

ANELLO **OR 060** (6.75x1,78) (Sim. 006706)
PER FORCELLA CAMBIO
VESPA 50-90-125 PRIMAVERA-ET3



ART. 7012

ANELLO **OR 070** (7,5x1,78) (Sim. 006707)



APE 50 - 50 FL2

ART. 7002

ANELLO **OR 160** (Sim. 006716)
PER LEVA FRENO
VESPA 50-90-125 PRIMAVERA - ET3



ART. 7013

ANELLO **OR 100** (9,5x1,78) (Sim. 006710)
(NBR 70)
APE 50 FL2



ART. 7003

ANELLO **OR 080** (8.73x1,78) (Sim. 006708)
PER LEVA COMANDO FRIZIONE
VESPA PX PE



ART. 7016

ANELLO **OR 362** (28,24X2,6) (Sim.93188-14013)
parapolvere per perno forcella
VESPA 50-90-125 PRIMAVERA ET3-PK 50



ART. 7007

ANELLO **OR 330** (24,99x3,53) (Sim.S.6733)
PARAPOLVERE PER PERNI FORCELLA
APE MP-CAR-TM-MP 601 CLASSIC 420 ('06-'07)
APE CALESSINO-VME 420 ('07-'12)
APE CALESSINO CITY 200 ('13-'15)-CLASSIC 400 ('14-'15)



ART. 7017

ANELLO **OR 135** (Sim.289254)
PER GIRANTE POMPAACQUA
SCOOTER
PIAGGIO - GILERA 50-125-150-180 cc.



ART. 7018

ANELLO (120x2,15) (Sim. 017781)
PER COPERCHIO FRIZIONE
VESPA PX 125-150-200-PX ARCOBALENO
GL 150-SPRINT 150-RALLY 180/200



ART. 7019

ANELLO (53,67x1,78)
PER KIT REVISIONE POMPAACQUA
SCOOTER
MOTORI MINARELLI-YAMAHA 50 cc.



SFERE UTILIZZI VARI

BALLS - VARIOUS USE

| | | | |
|--------------------|-------------------------|---------------------------|-----------------------|
| ART. 5618 | SFERA 5/16 - Ø mm.8 | per sr. sterzo inferiore | APE 50 - MP - TM |
| ART. 5619 | SFERA 5/32 - Ø mm.4 | per sr. sterzo superiore | APE 50 - MP - APE CAR |
| ART. 5629-A | SFERA 11/32 - Ø mm.8,70 | per sr. sterzo inferiore | APE CAR - TM |
| ART. 5620 | SFERA 1/4 - Ø mm.6,30 | per calottine perno ruota | CICLOMOTORI |
| ART. 5622 | SFERA 3/16 - Ø mm.4,80 | | |
| ART. 5627 | SFERA 1/8 - Ø mm.3,20 | | |
| ART. 5628 | SFERA 7/32 - Ø mm.5,50 | | |
| ART. 5629 | SFERA 9/32 - Ø mm.7,10 | | |





TABELLA RIEPILOGATIVA
SERIE PARAOLI MOTORE
OIL SEALS LIST

| CIF ART. | APPLICAZIONI / APPLICATIONS | |
|----------|--|---|
| 5695 | CIAO - SI' - BRAVO MONOMARCIA / WITHOUT VARIATOR | |
| 5695-V | CIAO - SI' - BRAVO CON VARIATORE / WITH VARIATOR | |
| 5696 | VESPA 50-90-125 PRIMAVERA - ET3 - PK 50 | |
| 5696-V | VESPA 50-90-125 PRIMAVERA - ET3 - PK 50 | Viton Oil seals |
| 5697 | APE 50 | |
| 5697-FL2 | APE 50 FL2 | |
| 5698 | APE MP P501-P601 - APE 500 - APE 600 | Black Viton Oil seals |
| 5698-1 | APE 501 PRIME SERIE FINO AL / TILL TO 1982 | Viton Oil seals |
| 5698-2 | APE MP 501 DAL / SINCE 1982--> | Viton Oil seals |
| 5699-C | VESPA PX 125 - 150 - PX ARCOBALENO | |
| 5699-CV | VESPA PX 125 - 150 - PX ARCOBALENO | Viton Oil seals |
| 6643 | VESPA GS 160 - VESPA 180 SS | |
| 6645 | VESPA RALLY 180 - 200 | |
| 6646 | VESPA SPRINT 150 (VLB1T) - SPRINT VELOCE VESPA GT 125 (VNL2T) - GTR 125 (VNL2T) - VNA-VNB-VBA-VBB VESPA SUPER - GL 150 (VLA1T) | |
| 6647-C | VESPA 125 (VM1/2T '53-'54)-125 (VN1/2 '54-'57)-(VNA 1/2T '58-'59) VESPA 150 (VL1/2/3T '55-'56)-(VB1T '57-'58) VESPA GS 150 (VS1/2/3/4/5 '55-'61) | CORTECO |
| 6647-R | VESPA 125 (VM1/2T '53-'54)-125 (VN1/2 '54-'57)-(VNA 1/2T '58-'59) VESPA 150 (VL1/2/3T '55-'56)-(VB1T '57-'58) VESPA GS 150 (VS1/2/3/4/5 '55-'61) | lato volano/frizione flywheel/clutch side ROLF |



CUSCINETTI
BEARINGS



TABELLA RIEPILOGATIVA
SERIE PARAOLI MOTORE
OIL SEALS LIST

| CIF ART. | APPLICAZIONI / APPLICATIONS | |
|----------|--|---|
| 6648-C | VESPA 150 (VLA1T '63-'64) - SPRINT 150 (VLB1T '65-'74) | CORTECO |
| 6648-R | VESPA 150 (VLA1T '63-'64) - SPRINT 150 (VLB1T '65-'74) | lato volano/frizione flywheel/clutch side ROLF |
| 6649 | VESPA PX 200 ARCOBALENO | |
| 6649-V | VESPA PX 200 ARCOBALENO | Viton Oil seals |
| 6650 | APE TM P602 - TM P703-CAR - MP CAMBIO RINFORZATO / REINFORCED GEAR SHIFT | Viton Oil seals |
| 6651 | VESPA PK 125 - PK 125 XL | |
| 6652 | VESPA 125 T5 | |
| 6652-V | VESPA 125 T5 | Viton Oil seals |
| 6653 | VESPA PK 50 XL - FL | |
| 6653-V | VESPA PK 50 XL - FL | Viton Oil seals |
| 6654 | MOTORI MINARELLI - YAMAHA APRILIA - MALAGUTI - MBK | |
| 6654-SR | MOTORI MINARELLI - YAMAHA APRILIA - MALAGUTI - MBK | |
| 6655-SR | MOTORI PIAGGIO-GILERA 50 cc. 2 TEMPI / 2 STROKE | |
| 6655-V | MOTORI PIAGGIO-GILERA 50 cc. 2 TEMPI / 2 STROKE PIAGGIO SFERA BASE - SFERA RST - MAQUILLAGE2 - ZIP BASE ZIP RST-FR - SP - NRG -RST MC2-NTT-FREE-QUARTZ VESPA ET2 - SKR CITY GILERA TYPHOON - X - EASY MOVING - STORM | Viton Oil seals |
| 6657-V | MOTORI PIAGGIO-GILERA 125 cc. 2 TEMPI / 2 STROKE PIAGGIO HEXAGON 125-150-LX-LXT 125-180 SKIPPER 125-150- SKIPPER LX 125-150 GILERA RUNNER FX-FXR 125-180 - TYPHOON 125 - X-XR 125 | Viton Oil seals |



CUSCINETTI BEARINGS

TABELLA RIEPILOGATIVA CUSCINETTI

| CIF ART. | MARCA / BRAND | DIMENSIONI | APPLICAZIONI / APPLICATIONS |
|-----------|-------------------|--------------|--|
| 16160-P | KG International | 8 - 22 - 7 | Pompa acqua motori / water pump engine : MINARELLI - YAMAHA |
| 16200-C3 | SKF 6200-C3 | 10 - 30 - 9 | Ingranaggio multiplo cambio / gearbox multiple gear VESPA 50-90-PRIM.ET3-PK-APE |
| 16207 | SKF 6200-2RSH | 10 - 30 - 9 | 2 lati schermati - asse ruota anteriore / 2 sides screened-front wheel axle MALAGUTI |
| 16206 | SKF 6300-2RSH | 10 - 35 - 11 | 2 lati schermati-asse ruota anteriore / 2 sides screened-front wheel axle MBK - YAMAHA |
| 16201 | SKF 6201-2RSH | 12 - 32 - 10 | Mozzo ruota Ciclomotore - ruota anteriore VESPA PX 1 [^] sr.-asse ruota anteriore YAMAHA Wheel hub, Moped - front wheel, VESPA PX 1 [^] sr. - front wheel axle |
| 16301-C3 | SKF 6301-C3 | 12 - 37 - 12 | Ingranaggio multiplo cambio / gearbox multiple gear VESPA 125-150 Old Models |
| 5821 | SKF 613963-C3 | 12 - 40 - 12 | Ingranaggio elastico / gear cluster shaft VESPA TS 125-GT125-SPRINT 150-SUPER 150-PX 125-150 (Sim.097718) |
| 5821-A | | 12 - 40 - 12 | Ingranaggio elastico / gear cluster shaft VESPA TS 125-GT125-SPRINT 150-SUPER 150-PX 125-150 (Sim.097718) |
| 16209 | SKF 6202-2RSH | 15 - 35 - 11 | 2 lati schermati-asse ruota ant./2 sides screened-front wheel axle VESPA ET2-ET4 - SFERA ... |
| 16202 | SKF 6202 | 15 - 35 - 11 | Banco CIAO - BRAVO - SI' - ruota anteriore / front wheel VESPA PX ARCOBALENO |
| 16202-C3 | SKF 6202-C3 | 15 - 35 - 11 | Banco CIAO - BRAVO - SI' |
| 5827-A | FAG | 15 - 42 - 13 | Albero primario / primary shaft VESPA 125-150 - SPRINT-RALLY-PX-PXE-COSA.... |
| 16203 | SKF 6203 | 17 - 40 - 12 | Banco MINARELLI - MORINI |
| 16203-C3 | SKF 6203-C3 | 17 - 40 - 12 | Banco MINARELLI - MORINI |
| 16210 | SKF 6203-2RSH | 17 - 40 - 12 | 2 lati schermati - ruota post./2 sides screened-rear wheel SCOOTER PIAGGIO-GILERA 50 cc. |
| 16155 | NTN | 17 - 42 - 13 | Banco lato volano / flywheel side motori Piaggio 50 cc. 4T (dal 2000) |
| 16303 | SKF 6303 | 17 - 47 - 14 | Banco applicazioni varie / generic applications |
| 16303-C3 | SKF 6303-C3 | 17 - 47 - 14 | Banco SCOOTER motori MINARELLI 6 V - lato frizione / clutch side VESPA |
| 16303-2RS | SKF 6303-2RS | 17 - 47 - 14 | Ammortizz.ant/post.ruota posteriore-braccio oscillante-ingranaggio trasmiss.PIAGGIO-GILERA |
| 5831-HQ | Made in Italy | | Albero ruota lato cambio / wheel shaft, gear change side V.125-150-GT-SUPER 125-150-SPRINT |
| 5825 | SKF | 20 - 42 - 9 | Asse ruota post. / rear wheel axle VESPA 50-125 OLD MODELS |
| 5825-A | | 20 - 42 - 9 | Asse ruota post. / rear wheel axle VESPA 50-125 OLD MODELS |
| 16204-NBB | NBB C3 | 20 - 47 - 14 | Banco motori MINARELLI-YAMAHA |
| 16204-C4 | SKF 6204-C4 | 20 - 47 - 14 | Banco motori MINARELLI-YAMAHA - lato volano / flywheel side VESPA 50 - PRIM.-ET3 |
| 16167-C4 | SKF 6204-NT9 C4 | 20 - 47 - 14 | Banco motori MINARELLI-YAMAHA |
| 16204-2RS | SKF 6204-2RS | 20 - 47 - 14 | 2 lati schermati - asse ruota post. / 2 sides screened-rear wheel axle SCOOTER PIAGGIO |
| 6204-NU | SKF (NU 6204-ECP) | 20 - 47 - 14 | A rulli,lato volano / roller bearing flywheel side SPECIFIC:VESPA PRIMAVERA ET3 (Sim.071605) |
| 6204-NUE | NRB (NU 6204-ECP) | 20 - 47 - 14 | A rulli,lato volano / roller bearing flywheel side SPECIFIC:VESPA PRIMAVERA ET3 (Sim.071605) |
| 16169 | NTN | 20 - 52 - 12 | Banco SCOOTER PIAGGIO - PEUGEOT BUXI - GEO (Sim.431125) |
| 16169-SKF | SKF - C4 | 20 - 52 - 12 | Banco scooter PIAGGIO-PEUGEOT BUXI - GEO (Sim.431125) |
| 16220 | SKF 62/22 | 22 - 50 - 14 | Mozzo ruota posteriore / rear wheel hub APE |
| 5829 | NA | 25 - 38 - 15 | Cuscinetto a rulli banco lato volano / flywheel side V.PX PE-SPRINT-PK 125 (Sim.033068) |
| 5829-8S | NA | 25 - 62 - 12 | Banco volano/frizione / flywheel/clutch side N. 8 sfere VESPA 125 - 150 - SPRINT - SUPER P125X - P150X-(V.PX 125 e 150 ARCOBALENO solo per lato frizione/only clutch) (Sim.097804) |
| 16005 | SKF 16005 | 25 - 47 - 8 | Carter alloggio campana friz./clutch drum V.50-90-125 PRIM-ET3-PK APE 50 (Sim.007130) |
| 16162 | SKF BB1 3056 C | 25 - 52 - 13 | Banco motori FRANCO MORINI ITAL.FORMULA 50 - MALAG.CROSSER - SUZUKI |
| 5823 | SKF NU 205EPC-C3 | 25 - 52 - 15 | Banco lato volano / flywheel side VESPA PX 125 T5 - RALLY 180-200 |
| 16170 | NTN | 25 - 56 - 12 | Banco lato frizione / clutch side motori 50 cc. 4T ('02-'04) |
| 16305-C3 | SKF 6305-C3 | 25 - 62 - 17 | Banco lato frizione / clutch side APE TM P703-P602-CAR P2/P3 |
| 16171 | NTN | 25 - 68 - 12 | Banco SCOOTER PIAGGIO SKIPPER 125-150 - EXAGON 125 e 150 SFERA RESTYLING 125 4T - GILERA TYPHOON 125 (Sim.431320) |
| 5836 | | 28 - 45 - 17 | Albero motore lato volano / flywheel side APE CAR P2/P3-MP-TM (Sim.134591) |
| 16060 | SKF 6206-C5 | 30 - 62 - 16 | motori ROTAX 125 - APRILIA RS 125 STRADALE - RX 125 ENDURO |
| 16061 | SKF 6206-C1040H | 30 - 62 - 16 | motori ROTAX 125 - APRILIA RS 125 STRADALE - RX 125 ENDURO |



KIT REVISIONE ALBERO MOTORE CRANKSHAFT REVISION KIT

TABELLA RIEPILOGATIVA **KIT** REVISIONE ALBERO MOTORE CRANKSHAFT REVISION KIT LIST

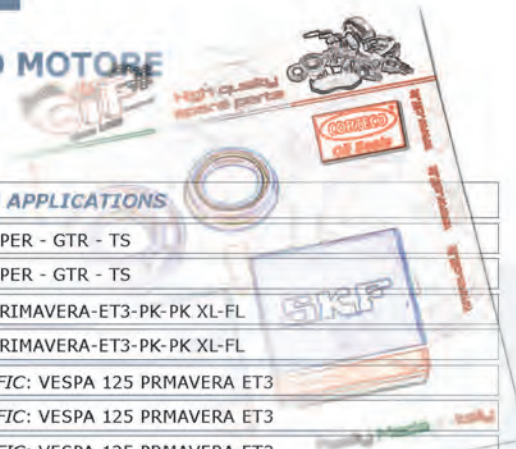

| VESPA | | | APPLICAZIONI / APPLICATIONS |
|----------|------------|----------------------|--|
| CIF ART. | CUSCINETTI | PARAOILI | |
| 5166-KTC | NA | CORTECO | VESPA SPRINT - SUPER - GTR - TS |
| 5166-KTR | NA | ROLF | VESPA SPRINT - SUPER - GTR - TS |
| 5169-KT | SKF | CORTECO | VESPA 50-90-125 PRIMAVERA-ET3-PK-PK XL-FL |
| 5169-KTV | SKF | CORTECO <i>Viton</i> | VESPA 50-90-125 PRIMAVERA-ET3-PK-PK XL-FL |
| 5170-KT | SKF + NRB | CORTECO | SPECIFICO / SPECIFIC: VESPA 125 PRMAVERA ET3 |
| 5170-KVE | SKF + NRB | CORTECO <i>Viton</i> | SPECIFICO / SPECIFIC: VESPA 125 PRMAVERA ET3 |
| 5170-KTV | SKF | CORTECO <i>Viton</i> | SPECIFICO / SPECIFIC: VESPA 125 PRMAVERA ET3 |
| 5171-KT | SKF | CORTECO | VESPA 98 (1946-1947) - VESPA 125 (1948-1952) |
| 5177-KT | SKF | CORTECO <i>Viton</i> | VESPA 98 (1946-1947) - VESPA 125 (1948-1952) |
| 5180-KT | NA | CORTECO | VESPA PX PE 125/150/200-PX PE ARCOBALENO |
| 5180-KTV | NA | CORTECO <i>Viton</i> | VESPA PX PE 125/150/200-PX PE ARCOBALENO |
| 5210-KT | SKF + NA | ROLF | VESPA RALLY 180/200 |
| 5212-KT | NA | ROLF | VESPA GS 150 (VS 1-2-3-4-5T) |
| 5214-KT | SKF + NA | CORTECO+ROLF+PHLE | VESPA GS 160 - VESPA 180 SS |

| APE | | | APPLICAZIONI / APPLICATIONS |
|----------|------------|----------------------|--------------------------------|
| CIF ART. | CUSCINETTI | PARAOILI | |
| 5220-KTV | SKF | CORTECO <i>Viton</i> | APE 50 1^ SERIE |
| 5221-KTV | SKF | CORTECO <i>Viton</i> | APE 50 FL2 |
| 5222-KTV | SKF + NA | CORTECO <i>Viton</i> | APE TM P703 - P602 - CAR P2/P3 |

| CICLOMOTORI / MOPEDS | | | APPLICAZIONI / APPLICATIONS |
|----------------------|------------|----------|---|
| CIF ART. | CUSCINETTI | PARAOILI | |
| 5182-KT | SKF | CORTECO | PIAGGIO CIAO - BRAVO - SI |
| 16184-KT | SKF | CORTECO | MOTORI MINARELLI 6 VELOCITA'/SPEED |
| 16191-KT | SKF | PHLE | MOTORI DERBI 6 VELOCITA'/SPEED (Francia/Spagna) |

| SCOOTER | | | APPLICAZIONI / APPLICATIONS |
|------------|------------|----------------------|---|
| CIF ART. | CUSCINETTI | PARAOILI | |
| 16180-KT | NTN | ROLF | MOTORI PIAGGIO-GILERA 50 cc. 2 TEMPI - 2 STROKE |
| 16180-KTV | NTN | CORTECO <i>Viton</i> | PIAGGIO FREE - LIBERTY - NRG - NTT - QUARTZ - SFERA |
| 16380-KT | SKF | ROLF | VESPA ET2 - ZIP - FAST RAIDER |
| 16380-KTV | SKF | CORTECO <i>Viton</i> | GILERA DNA - RUNNER - STALKER - STORM - TYPHOON |
| 16412-KT | NTN | CORTECO | MOT.PIAGGIO 50 cc. 4 TEMPI-VERSIONE 2002 - LIBERTY 50 4T |
| 16416-KT | NTN | CORTECO | MOT.PIAGGIO 50 cc. 4 TEMPI-MOTORI CHIN |
| 16182-KT | NTN | CORTECO | MOT.PIAGGIO-GILERA 125/150/180 cc. 2 TEMPI / STROKE |
| 16186-KTC4 | SKF | CORTECO | MOTORI MINARELLI - YAMAHA |
| 16186-KTE | SKF | CORTECO | APRILIA - MALAGUTI - MBK |
| 16186-NBB | NBB | CORTECO | |
| 16192-KT | SKF | CORTECO | MOT.MORINI DITECH H20 2000 Versione Carburatore e Iniezione |
| 16187-KT | NTN | CORTECO | MOTORI PEUGEOT 50 cc. |
| 16387-KT | SKF | CORTECO | BUXI-ELYSEO-LOOXOR-METAL X-SPEEDAKE-SPEED FIGHT-QUAB |
| 16400-KT | SKF | CORTECO | SV GEO TREKKER - VIVACITY - X FIGHT - X RACE - ZENITH |
| 16403-KT | SKF | CORTECO | MOTORI PEUGEOT 50 cc. - LUDIX 50 |
| | | | MOTORI PEUGEOT CILINDRO VERTICALE E POMPA OLIO ELETTRONICA |

PORTA TARGA

LICENSE PLATE HOLDER

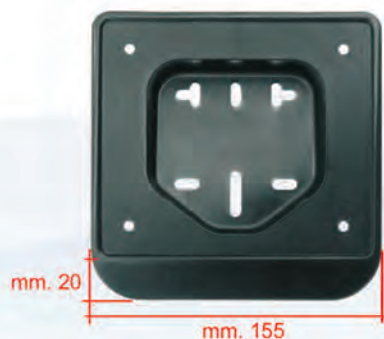

ART. 3281

PORTA TARGA IN PLASTICA NERO IN MATERIALE ANTIURTO CON SPAZIO PUBBLICITARIO

PER TARGHE (NORMATIVA 2004/2006)

LICENSE PLATE HOLDER (NEW DIMENSIONS 2004/2006)
BLACK PLASTIC IN IMPACT RESISTANT MATERIAL

SCOOTER - CICLOMOTORI / MOPEDS

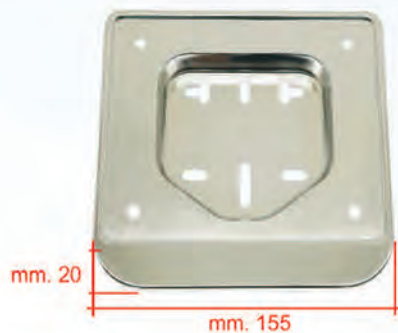

ART. 3281-C

PORTA TARGA IN PLASTICA CROMATA IN MATERIALE ANTIURTO CON SPAZIO PUBBLICITARIO

PER TARGHE (NORMATIVA 2004/2006)

LICENSE PLATE HOLDER (NEW DIMENSIONS 2004/2006)
CHROMED PLASTIC IN IMPACT RESISTANT MATERIAL

SCOOTER - CICLOMOTORI / MOPEDS



ART. 3282-IX

CORNICE TARGA INOX LUCIDATA (PER TARGHE A 6 CIFRE)

POLISHED INOX RIM LICENCE PLATE (6 DIGIT PLATES)

DIMENSIONI / DIMENSIONS: mm.150x130

CICLOMOTORI E VESPA 50 TUTTE
MOPEDS AND ALL VESPA 50



ART. 3289

PORTA CONTRASSEGNO A DUE POSIZIONI IN PLASTICA NERO
INSURANCE STAMP HOLDER (2 POSITIONS) IN BLACK PLASTIC

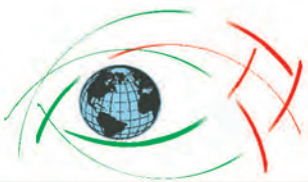

PORTA TARGA LICENSE PLATE HOLDER

MODELLI VESPA VINTAGE VERSIONE ORIGINALE OLD VESPA MODEL ORIGINAL VERSION



ART. 3278

PORTA TARGA

VESPA VECCHI MODELLI
VESPA 125 FINO AL 1962
VESPA 150 FINO AL 1961

(Sim. 018306)

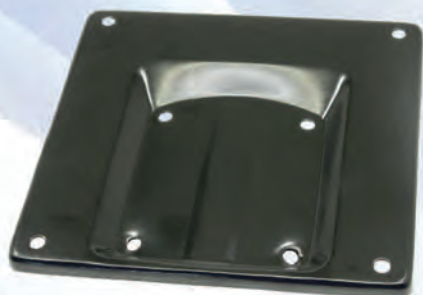

ART. 3279

PORTA TARGA RIALZATO GREZZO
VECCHIE DIMENSIONI

VESPA 90 - 90SS
VESPA 125 PRIMAVERA - ET3

(Sim. 0704106)



ART. 3286

PORTA TARGA IN ALLUMINIO / ALUMINIUM

VESPA GS 150 (VS1->VS5)
VESPA GS 160 (PRIMO TIPO / FIRST TYPE)

PORTA TARGA

LICENSE PLATE HOLDER

PORTA TARGA E CORNICI GENERICHE VECCHIE DIMENSIONI (mm.170x170)

GENERIC LICENSE PLATE HOLDER AND RIMS OLD DIMENSION (mm.170x170)



mm. 170

ART. **3280-C**

FONDO PORTA TARGA
IN FERRO CROMATO
VECCHIE DIMENSIONI **mm. 170**

LICENSE PLATE HOLDER,
CHROMED IRON
OLD DIMENSIONS mm. 170

PER VESPA E MOTO/MOTORCYCLES



mm. 170

ART. **3277**

CORNICE TARGA
IN FERRO CROMATO
VECCHIE DIMENSIONI
mm. 170

LICENSE PLATE RIM,
CHROMED IRON
OLD DIMENSIONS mm. 170

PER VESPA E MOTO



mm. 170

ART. **3277-IX**

CORNICE TARGA
INOX LUCIDATA
VECCHIE DIMENSIONI
mm. 170

HIGH QUALITY

LICENSE PLATE RIM,
POLISHED INOX
OLD DIMENSIONS mm. 170

PER VESPA E MOTO



mm. 170

ART. **3280**

FONDO PORTA TARGA
IN FERRO VERNICIATO NERO
VECCHIE DIMENSIONI **mm. 170**

LICENSE PLATE HOLDER
BLACK PAINTED IRON
OLD DIMENSIONS mm. 170

PER VESPA E MOTO/MOTORCYCLES



mm. 170

ART. **3277-N**

CORNICE TARGA NERA
VECCHIE DIMENSIONI
mm. 170

HIGH QUALITY

LICENSE PLATE RIM, BLACK
OLD DIMENSIONS mm. 170

PER VESPA E MOTO



PORTA TARGA LICENSE PLATE HOLDER

DIMENSIONI mm.177x177 **NORMATIVA GENNAIO 1999**
DIMENSIONS mm.177x177 1999 JANUARY REGULATION



ART. **3280-NT**

FONDO TARGA
TIPO GRANDE IN FERRO VERNICIATO NERO

PER TARGHE mm. 177x177

LICENSE PLATE HOLDER IN BLACK PAINTED IRON
PER MOTO / MOTORCYCLES



ART. **3277-NT**

CORNICE PER FONDO TARGA
TIPO GRANDE IN FERRO VERNICIATO NERO

PER TARGHE mm. 177x177

LICENSE PLATE RIM, BLACK PAINTED IRON
PER MOTO / MOTORCYCLES



ART. **3280-CNT**

FONDO TARGA
TIPO GRANDE IN FERRO CROMATO

PER TARGHE mm. 177x177

LICENSE PLATE HOLDER, CHROMED IRON
PER MOTO / MOTORCYCLES



ART. **3277-CNT**

CORNICE PER FONDO TARGA
TIPO GRANDE IN FERRO CROMATA

PER TARGHE mm. 177x177

LICENSE PLATE RIM, CHROMED IRON
PER MOTO / MOTORCYCLES

PORTA TARGA

LICENSE PLATE HOLDER



ART. 3287

PORTA TARGA IN PLASTICA NERO

PER TARGHE FINO AL 1998
VECCHIE DIMENSIONI **mm. 170x170**

IN MATERIALE ANTIURTO ALLOGGIO TARGA AD INCASSO
(CON SPAZIO PUBBLICITARIO)

*LICENSE PLATE (TILL TO 1998) - OLD DIMENSION mm. 170x170
IN BLACK PLASTIC, IMPACT RESISTANT MATERIAL
(WITH SPACE FOR ADVERTISING)*

PER MOTO / MOTORCYCLES



ART. 3285

CORNICE TARGA IN PLASTICA NERA (ANTIURTO)

PER TARGHE FINO AL 1998
VECCHIE DIMENSIONI **mm. 170x170**

*LICENSE PLATE RIM (TILL TO 1998) - OLD DIMENSION mm. 170x170
IN BLACK PLASTIC, IMPACT RESISTANT MATERIAL*

PER MOTO / MOTORCYCLES



ART. 3287-NT

PORTA TARGA NERO
TIPO GRANDE IN NYLON ANTIURTO
(CON SPAZIO PUBBLICITARIO)

PER TARGHE mm. 177x177

*LICENSE PLATE HOLDER IN BLACK NYLON
IMPACT RESISTANT MATERIAL (WITH SPACE FOR ADVERTISING)*

PER MOTO / MOTORCYCLES



CATARINFRANGENTE REFLECTOR



PIAGGIO - GILERA U.S.A



OMOLOGAZIONE - APPROVAL
02550.36
SAE A99DOT
SIEM 7620

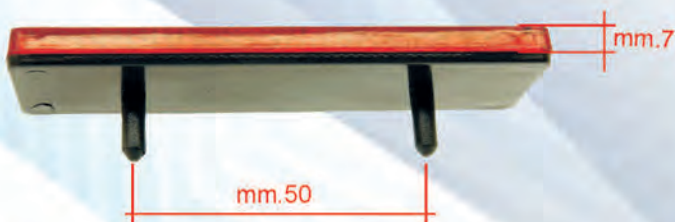
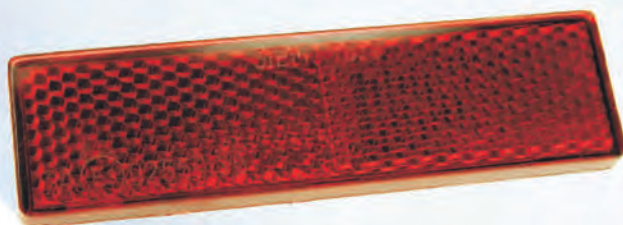

ART. **1698-OR**

CATARINFRANGENTE SIEM OMOLOGATO
REFLECTOR, SIEM APPROVED

mm.90x25
spessore mm.7
interasse pioli fissaggio mm.50

specifico per veicoli / specific for vehicles:
GILERA-PIAGGIO U.S.A

PIAGGIO:

FREE 50 (92-94) - FREE FL 50 (95-02)
FREE DELIVERY 50 (00-01) - FREE 100 (02-03)
NRG 50 (94-96) - NRG EXTREME 50 (99-00)
NRG MC3 50 (01-04) - NRG PUREJET 50 (02-04)
NRG RST MC2 50 (96-98)
NTT 50 (95-96)
QUARTZ 50 (92-96)
SKIPPER 125 (94-97)
SKR CITY 80 (99)
MP3 RL SPORT - BUSINESS 500 (11-12)
MP3 300 LT BUSINESS-SPORT ABS-ENJOY 300 (14-16)
MP3 IE E4 LT BUSINESS - SPORT ABS 300 (16-18)
MP3 400 (07-08) - MP3 IE LT
MP3 IE LT SPORT 400 (08-10)
MP3 IE LT TOURING 400 (11)
MP3 LT BUSINESS ABS 500 (14-16)
MP3 LT E4 SPORT-BUSINESS 500 (16-18)
MP3 LT SPORT - BUSINESS 500 (11-13)
MP3 MAXI SPORT E4 ABS 350 (18-19)
MAXI SPORT-BUSINESS ADVANCED E4 ABS 500 (18-19)
MP3 MIC 400 (08-10)
MP3 RL TOURING 400 (11)
MP3 SPORT ABS 500 (14-16)

GILERA :

TYPHOON 50 (01-08) - TYPHOON 50 (09-11)

generico : applicazioni varie
generic : various applications

(Sim. 291081 - 638745)

LAMPADINE OMOLOGATE

APPROVED LIGHT BULBS



ELENCO RIEPILOGATIVO LAMPADINE OMOLOGATE E

APPROVED LIGHT BULBS LIST

| | | | | | | |
|------------------------|--------------------|-----------|-----|--------|--|--|
| ART. 1400 | LAMPADINA BILUCE | BA 20D | 6V | 25/25W | | |
| ART. 1401 | LAMPADINA BILUCE | BA 20D | 6V | 15/15W | | |
| ART. 1403 | LAMPADINA BILUCE | BA 20D | 6V | 35/35W | | |
| ART. 1406 | LAMPADINA BILUCE | BA 20D | 12V | 25/25W | | |
| ART. 1407 | LAMPADINA BILUCE | BA 20D | 12V | 35/35W | | |
| ART. 1408 | LAMPADINA BILUCE | BA 20D | 12V | 45/40W | | |
| ART. 1436 | LAMPADINA | BA 7s | 6V | 1,2W | | |
| ART. 1437 | LAMPADINA | BA 7s | 12V | 2W | | |
| ART. 1409 | LAMPADINA | BA 9s | 6V | 5W | | |
| ART. 1409-A | LAMPADINA | BA 9s | 6V | 3W | | |
| ART. 1410 | LAMPADINA | BA 9s | 12V | 4W | | |
| ART. 1414 | LAMPADINA | BA 15s | 6V | 5W | | |
| ART. 1416 | LAMPADINA | BA 15s | 6V | 10W | | |
| ART. 1418 | LAMPADINA | BA 15s | 12V | 5W | | |
| ART. 1418-RED | LAMPADINA-ROSSA | BA 15s | 12V | 5W | | |
| ART. 1419 | LAMPADINA | BA 15s | 12V | 10W | | |
| ART. 1419-RED | LAMPADINA-ROSSA | BA 15s | 12V | 10W | | |
| ART. 1420-FR | LAMPADINA | BA 15s | 12V | 21W | | |
| * ART. 1413-FRA | LAMPADINA-AMBRA | BA 15s | 12V | 21W | | |
| ART. 1411 | LAMPADINA | BAY 15d | 6V | 15/3W | | |
| ART. 1412 | LAMPADINA | BAY 15d | 12V | 21/5W | | |
| ART. 1415-FRA | LAMPADINA-AMBRA | BAU 15s | 12V | 10W | | |
| * ART. 1417-FRA | LAMPADINA-AMBRA | BAU 15s | 12V | 21W | | |
| ART. 1421 | LAMPADINA A SILURO | Ø 8x31 | 6V | 3W | | |
| ART. 1427-A | LAMPADINA A SILURO | Ø 8x38 | 6V | 3W | | |
| ART. 1425 | LAMPADINA A SILURO | Ø 10,5x38 | 6V | 10W | | |
| ART. 1426 | LAMPADINA A SILURO | Ø 10,5x38 | 6V | 5W | | |
| ART. 1422 | LAMPADINA A SILURO | Ø 10,5x38 | 12V | 10W | | |
| ART. 1423 | LAMPADINA A SILURO | Ø 10,5x38 | 12V | 5W | | |
| ART. 1428 | LAMPADINA A SILURO | Ø 15x43 | 6V | 15W | | |
| ART. 1428-A | LAMPADINA A SILURO | Ø 15x43 | 6V | 18W | | |
| ART. 1429 | LAMPADINA A SILURO | Ø 15x43 | 12V | 15W | | |
| ART. 1432 | LAMPADINA | P26s | 6V | 15W | | |
| ART. 1434 | LAMPADINA | P26s | 12V | 15W | | |



LAMPADINE OMOLOGATE

APPROVED LIGHT BULBS

ELENCO RIEPILOGATIVO LAMPADINE OMOLOGATE E

APPROVED LIGHT BULBS LIST



| | | | | | | |
|------------------------|-----------------|----------------------|-----|--|---|----------|
| ART. 1438 | LAMPADINA | W2x4,6 T5 MINI WEDGE | 12V | 1,2W |  | mm.4,6 |
| ART. 1466 | LAMPADINA | W2,1x9,5d W5WT10 | 12V | 5W |  | mm.9,5 |
| * ART. 1466-FRA | LAMPADINA-AMBRA | W2,1x9,5d WY5WT10 | 12V | 5W  |  | mm.9,5 * |
| ART. 1465 | LAMPADINA | W2,1x9,5d W16WT15 | 12V | 16W |  | mm.9,5 |



ART. **1440**
BA 20d 12V 35/35W
LAMPADINA XENON
(BIANCA / WHITE)



ART. **1450-H**
BA 20d 12V 35/35W
LAMPADINA HALOGEN



ART. **1442-H**
P26s 6V 15W
LAMPADINA HALOGEN



ART. **1444-H**
P26s 12V 15W
LAMPADINA HALOGEN



ART. **1453-H**
H1 P14,5s 12V 55W
LAMPADINA HALOGEN
(Sim.580141)



ART. **1456-H**
HS1 12V 35/35W
LAMPADINA HALOGEN
(Sim.231215)



ART. **1459-H**
H4 P43 E13 12V 60/55W
3 ATTACCHI/CONNECTIONS
LAMPADINA HALOGEN



ART. **1454-H**
H7 PX26d E13 12V 55W
LAMPADINA HALOGEN



ART. **1455-H**
H8 PGJ 19-1 12V 35W
LAMPADINA HALOGEN
(Sim.580734)



ART. **1457-H**
H11 PGJ 19-2 12V 55W
LAMPADINA HALOGEN
(Sim.640754)

CHIAVI CANDELA

SPARK PLUG TOOLS



ART. **3300** ESAGONO 11 x 13 x 21 VESPA 50-90-125 ET3-PK-FL-FL2

ART. **3301** ESAGONO 13 x 17 x 21 VESPA 50-90-125 ET3-PK-FL-FL2

ART. **3302** ESAGONO 11 x 17 x 21 VESPA 50-90-125 ET3-PK-FL-FL2

ART. **3303** ESAGONO 13 x 13 x 21 VESPA 125 ET3



ART. **3304** ESAGONO 14 X 22 X 11 VESPA 125 - 150

ART. **3305** ESAGONO 13 X 22 X 11 VESPA 125 - 150

PER TUTTE LE VESPE / FOR ALL VESPA

(ESCLUSO / EXCEPT: VESPA 50-90-125 PRIMAVERA- PRIMAVERA ET3)



ART. **3290** CHIAVE A PIPA ESAGONO 13 X 21

CICLOMOTORI / MOPEDS



ART. **3328** CHIAVE CON SPINA ESAGONO 21

CICLOMOTORI / MOPEDS



ART. **3310** CHIAVE UNIVERSALE / UNIVERSAL KEY

ESAGONO 21



ART. **3329**

KIT CHIAVI A TUBO DIRITTE (N. 8 PZ.)

SPARK PLUG KEYS SET (No. 8 PCS.)

ESAGONI / HEXAGONS:

(5 x 7) - (6 x 8) - (10 x 11) - (12 x 13)
(14 x 15) - (16 x 17) - (18 x 19) - (20 x 22)





CANDELE
SPARK PLUGS

DELLORTO



ART. **1100**

Candela BOSCH **W7AC** - filetto **CORTO** (NGK **B6HS**)
SPARK PLUG BOSCH **W7AC** - **SHORT** thread (NGK **B6HS**)

APPLICATIVI **SUGGERITI** / SUGGESTED APPLICATIONS:

VESPA DAL 1946 AL 1977
VESPA 98 - VESPA 50 - 50 SPECIAL - N - L - R
VESPA 125 ('50-'52) da V30 a V33
VESPA 125 ('53-'57) VM1-2 - VN1-2 - VNA1-2 - dal VNB1 al VNB6
VESPA 125/150 SUPER-125 GT-GTR-SPRINT VELOCE-SPRINT
VESPA 150 ('55-'65) - VL1-2-3 - VB1-VBA-VBB1-VBB2
VESPA PX 125/150
CIAO SI' - BRAVO - BOXER



ART. **1106**

Candela BOSCH **W8AC** - filetto **CORTO** (NGK **B5HS**)
SUPER R0 191 - ELETTRODO IN RAME

SPARK PLUG BOSCH **W8AC** - **SHORT** thread (NGK **B5HS**)
SUPER R0 191 - CU-ELECTRODE

APPLICATIVI **SUGGERITI** / SUGGESTED APPLICATIONS:

CICLOMOTORI ANNI '60 - '70
GARELLI - FANTIC - RIZZATO - MALAGUTI

ATTACCHI CANDELA

SPARK PLUG CONNECTIONS



ART. 9124

ATTACCO CANDELA FILETTO mm. 4 IN GOMMA NERO
PER CAVO CANDELA Ø mm. 5 (CANDELA Ø mm. 14)

SPARK PLUG CUP THREAD mm. 4 - IN BLACK RUBBER
FOR SPARK PLUG CABLE mm. 5 - (SPARK PLUG Ø mm. 14)



ART. 9125-N

ATTACCO CANDELA FILETTO mm. 4 IN GOMMA NERO
PER CAVO CANDELA Ø mm. 7 (CANDELA Ø mm. 14)

SPARK PLUG CUP THREAD mm. 4 - IN BLACK RUBBER
FOR SPARK PLUG CABLE mm. 7 - (SPARK PLUG Ø mm. 14)

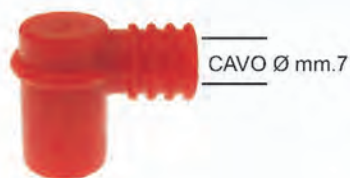

ART. 9125

ATTACCO CANDELA FILETTO mm. 4 IN SILICONE ROSSO
PER CAVO CANDELA Ø mm. 7 (CANDELA Ø mm. 14)

SPARK PLUG CUP THREAD mm. 4 - IN RED SILICONE
FOR SPARK PLUG CABLE mm. 7 - (SPARK PLUG Ø mm. 14)



ART. 9115

ATTACCO CANDELA BARILOTTO "SAE" mm. 6,2
IN GOMMA NERO - PER CAVO Ø mm.7

SPARK PLUG CUP IN BLACK RUBBER - KEG "SAE" mm.6,2
FOR CABLE Ø mm.7

APPLICAZIONI VARIE / VARIOUS APPLICATIONS
CIAO - BRAVO - BOXER - Sì



ART. 9116

ATTACCO PER CANDELA mm.9-10
IN SILICONE NERO SCHERMATO 5K
BARILOTTO "SAE" mm. 6,2 - PER CAVO Ø mm.7

CUP FOR SPARK PLUG mm.9-10
BLACK SILICONE, 5K SCREENED
KEG "SAE" mm.6,2 - FOR CABLE Ø mm.7

SCOOTER - SCOOTERONI
RAFFREDDAMENTO / COOLING H2o



ATTACCHI CANDELA

SPARK PLUG CONNECTIONS



ART. 9001-KT

KIT ATTACCO CANDELA FILETTO mm.4
PER CAVO Ø mm.7
(NR.3 PEZZI)

*KIT SPARK PLUG CUP - THREAD mm.4
FOR CABLE Ø mm.7
(No. 3 PCS.)*

MINARELLI - MORINI - SUZUKI
RAFFREDDAMENTO ARIA / COOLING AIR



ART. 9003-KT

KIT ATTACCO CANDELA FILETTO mm.4
PER CAVO Ø mm.7
(NR.3 PEZZI)

*KIT SPARK PLUG CUP - THREAD mm.4
FOR CABLE Ø mm.7
(No. 3 PCS.)*

SCOOTER
VARIE APPLICAZIONI PER MOTORI RAFFREDDAMENTO H2o
VARIOUS APPLICATION FOR ENGINE H2o COOLING



ART. 9007-KT

KIT ATTACCO CANDELA - BARILOTTO "SAE" mm.6,2
PER CAVO Ø mm.7
(NR.3 PEZZI)

*KIT SPARK PLUG CUP - KEG "SAE" mm.6,2
FOR CABLE Ø mm.7
(No. 3 PCS.)*

MOTORI PIAGGIO - MINARELLI
RAFFREDDAMENTO ARIA / AIR COOLING



ATTACCHI CANDELA SPARK PLUG CONNECTIONS



ART. **9127-A**
ATTACCO CANDELA
PER CANDELA / FOR SPARK PLUG
Ø mm. 14



ART. **9127-B**
ATTACCO CANDELA
PER CANDELA / FOR SPARK PLUG
Ø mm. 10/12



ART. **9127-C**
ATTACCO CANDELA
PER CANDELA / FOR SPARK PLUG
Ø mm. 10/12



ART. **9127-D**
ATTACCO CANDELA
PER CANDELA / FOR SPARK PLUG
Ø mm. 10/12



ART. **9127-E**
ATTACCO CANDELA
PER CANDELA CON OLIVA FISSA
FOR SPARK PLUG WITH FIXED OLIVE
PER CANDELA / FOR SPARK PLUG
Ø mm. 10/12
(Sim. 293845)

PIAGGIO
BEVERLY 125-250-500-CRUISER 250-EU3 125-400-EU3 500
BEVERLY EU3 MIC 125-250-EU3 SPORT 125-IE EU3 250-RST 125-250
BEVERLY SPORT 250-TOURER EU3 125-250-300-EU3 400
CARNABY 125-200-HEXAGON GTX 125-LIBERTY 125
MP3 250-400-IE LT-MP3 IE LT SPORT 400-IE LT TOURING 400
MP3 LT 250-LT SPORT-BUSINESS 500-MIC 250-400-RL SPORT
MP3 BUSINESS 500-RL TOURING 400
SFERA 125-SKIPPER 4T 125-SUPER HEXAGON GTX 12 125
VESPA ET4 125-X EVO 250-400-X7 EU3 250-X8 EU3 400
X9 125-200-500-X9 AMALFI 180
X9 EVOLUTION 125-200-250-500-EVOLUTION ABS 500

GILERA:
DNA 125-FUOCO EU3 500-NEXUS 500-EU3 125-EU3 250-EU3 300
NEXUS 500-EU3 IE 125-SP EU3 250
RUNNER 4T ST EU3 125-VX 125-VX 4T EU3 125-VX RACE 125-200
RUNNER VX SC 125-VX 125-VXR 200-VXR 4T ST EU3 200
RUNNER VXR EU3 200



ART. **9123**
ATTACCO CANDELA MODELLO ORIG.
PER CANDELA / FOR SPARK PLUG Ø mm. 14
CIAO - BRAVO - SI'
(Sim. 103936)



ART. **9126**
ATTACCO CANDELA A FORCELLA



CAVI CANDELA

SPARK PLUG CABLES



ART. **9120-D5**

CAVO CANDELA **Ø 5 mm.**

MORBIDO COLORE NERO

SPARK PLUG CABLE
BLACK SOFT MATERIAL

(conf./pack 5 mt.)



ART. **9120-D7**

CAVO CANDELA **Ø m. 7**

CLASSE E SCHERMATO IN SILICONE
COLORE NERO

SPARK PLUG CABLE,
CLASS E COPPER SILICONE BLACK COLOUR

VESPA TUTTI TIPI / ALL MODELS

(conf./pack 5 mt.)

ART. **G0849**

CAPPUCCIO CANDELA
SPARK PLUG CAP

VESPA 50-90-125 PRIMAVERA-ET3
APE 50 - 250

(Sim.072843)



ART. **G0659**

CAPPUCCIO CANDELA
SPARK PLUG CAP

VESPA 125/150
VESPA P125X / P150X

(Sim.46741)



GUAINA

SHEAT

HIGH QUALITY



10 mt.

CON TUBETTO INTERNO "PHED" / WITH "PHED" INNER TUBE

SPIRALE
ESTERNO
SPIRAL
EXTERNAL

Ø
mm. 5

SPIRALE
INTERNO
SPIRAL
INTERNAL

Ø
mm. 2,8

ESTERNO GUAINA
PLASTIFICATA
PLASTICIZED
SHEATH EXTERNAL

Ø
mm. 5,8

ART. **8721-G**

GUAINA GRIGIA **HIGH QUALITY** SPIRALE IN ACCIAIO PIATTA
TUBETTO INTERNO " PHED "
(FACILITA LO SCORRIMENTO DEL CAVO ALL'INTERNO DELLA GUAINA)
(MATASSINA DA 10 MT.)

GREY SHEAT **HIGH QUALITY** PLAIN STEEL SPIRAL
" PHED " INNER TUBE (EASY SLIDING CABLE IN THE SHEAT)
(ROLL OF 10 MT.)



ART. **3504** CAPOGUAINA
Ø interno / internal mm.6
Ø esterno / external mm.6,60



ART. **3514** BUSSOLETTA A GRADINO
Ø interno / internal mm.6,9
Ø esterno / external mm.8

GUAINA

SHEAT (SCOOTER - VESPA - CICLOMOTORI - MOTO)

SPIRALE ESTERNO / EXTERNAL SPIRAL Ø mm.4,5
SPIRALE INTERNO / INTERNAL SPIRAL Ø mm.2,5

ESTERNO GUAINA PLASTIFICATA Ø mm.5,2
 PLASTICIZED EXTERNAL SHEAT

ART. 4520-N

NERA - LISCIA
 BLACK - SMOOTH

SPIRALE IN ACCIAIO
 STEEL SPIRED

(ROTOLO DA MT. 50 SCATOLATO)

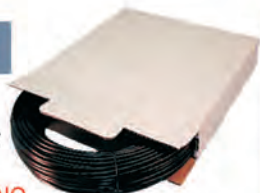

ART. 4520-G

GRIGIA - LISCIA
 GREY - SMOOTH

SPIRALE IN ACCIAIO
 STEEL SPIRED

(ROTOLO DA MT. 50 SCATOLATO)



ART. 4520-Z

GRIGIA
 GREY

QUADRETTATA
 SPIRALE IN ACCIAIO
 SQUARED, STEEL SPIRED

(ROTOLO DA MT. 50 SCATOLATO)



ART. 3502 CAPOGUAINA
 Ø interno / internal mm.5,5
 Ø esterno / external mm.6



ART. 3512 BUSSOLETTA A GRADINO
 Ø interno / internal mm.6,2
 Ø esterno / external mm.7

SPIRALE ESTERNO / EXTERNAL SPIRAL Ø mm.5
SPIRALE INTERNO / INTERNAL SPIRAL Ø mm.2,8

ESTERNO GUAINA PLASTIFICATA Ø mm.5,8
 PLASTICIZED EXTERNAL SHEAT

ART. 4521-N

NERA - LISCIA
 BLACK - SMOOTH

SPIRALE IN ACCIAIO
 STEEL SPIRED

(ROTOLO DA MT. 50 SCATOLATO)

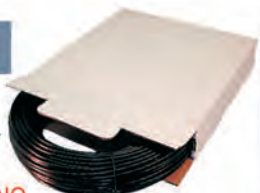

ART. 4521-G

GRIGIA - LISCIA
 GREY - SMOOTH

SPIRALE IN ACCIAIO
 STEEL SPIRED

(ROTOLO DA MT. 50 SCATOLATO)



ART. 4521-Z

GRIGIA
 GREY

QUADRETTATA
 SPIRALE IN ACCIAIO
 SQUARED, STEEL SPIRED

(ROTOLO DA MT. 50 SCATOLATO)



ART. 3504 CAPOGUAINA
 Ø interno / internal mm.6
 Ø esterno / external mm.6,60



ART. 3514 BUSSOLETTA A GRADINO
 Ø interno / internal mm.6,9
 Ø esterno / external mm.8

SPIRALE ESTERNO / EXTERNAL SPIRAL Ø mm.6
SPIRALE INTERNO / INTERNAL SPIRAL Ø mm.3,4

ESTERNO GUAINA PLASTIFICATA Ø mm.7
 PLASTICIZED EXTERNAL SHEAT

ART. 4522-N

NERA - LISCIA
 BLACK - SMOOTH

SPIRALE IN ACCIAIO
 STEEL SPIRED

(ROTOLO DA MT. 50)

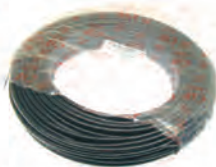

ART. 4522-G

GRIGIA - LISCIA
 GREY - SMOOTH

SPIRALE IN ACCIAIO
 STEEL SPIRED

(ROTOLO DA MT. 50)



ART. 4522-Z

GRIGIA
 GREY

QUADRETTATA
 SPIRALE IN ACCIAIO
 SQUARED, STEEL SPIRED

(ROTOLO DA MT. 50)



ART. 3506 CAPOGUAINA
 Ø interno / internal mm.7,2
 Ø esterno / external mm.8



ART. 3516 BUSSOLETTA A GRADINO
 Ø interno / internal mm.8,2
 Ø esterno / external mm.10



MINUTERIA SPARE PARTS

CAPOGUAINA ZINCATI BIANCHI TERMINAL FIXING SHEAT - WHITE ZINCED



INTERNO
INTERNAL
Ø

ESTERNO
EXTERNAL
Ø

| | | | |
|------------------|---------|---------|------------------------------|
| ART. 3500 | mm.5 | mm.5,70 | per guaina spirale Ø mm. 3,9 |
| ART. 3502 | mm.5,5 | mm.6 | per guaina spirale Ø mm. 4,5 |
| ART. 3504 | mm.6 | mm.6,60 | per guaina spirale Ø mm. 5 |
| ART. 3506 | mm.7,20 | mm.8 | per guaina spirale Ømm. 6 |

BUSSOLETTE A GRADINO BUSHES



INTERNO
INTERNAL
Ø

ESTERNO
EXTERNAL
Ø

| | | | |
|------------------|---------|-------|------------------------------|
| ART. 3512 | mm.6,2 | mm.7 | per guaina spirale Ø mm. 4,5 |
| ART. 3514 | mm.6,9 | mm.8 | per guaina spirale Ø mm. 5 |
| ART. 3516 | mm.8,2 | mm.10 | per guaina spirale Ø mm. 6 |
| ART. 3518 | mm.10,3 | mm.12 | per guaina spirale Ø mm. 7 |

ART. **3562**

BARILOTTO x leva comandi
lever KEG

Ø esterno / external mm. 9



ART. **3568**

BARILOTTO x leva comandi
lever KEG

Ø esterno / external mm. 8



ART. **3567**

BARILOTTO / KEG
per leva comandi CIAO (ns.5895)

Ø esterno / external mm. 9



MORSETTI SERRAFILO - vite in testa GEAR CABLE CLAMPS - screw in head

ART. **3530** MORSETTO per filo cambio
gear cable clamps VESPA

ART. **3532** MORSETTO per filo cambio
gear cable clamps APE MP

ART. **3534** Ø foro mm.2,1 - Ø barilotto esterno mm.6

ART. **3536** Ø foro mm.2,3 - Ø barilotto esterno mm.7

ART. **3538** Ø foro mm.2,7 - Ø barilotto esterno mm.8

ART. **3540** MORSETTO gas tipo pratic
Ø foro mm.1,6 - Ø barilotto esterno mm.4

ART. **3542** MORSETTO gas tipo pratic
Ø foro mm.2,2 - Ø barilotto esterno mm.5

ART. **3546** MORSETTO gas con vite a grano
tipo Tommaselli
Ø foro mm.2 - Ø barilotto esterno mm.5,5

ART. **3548** MORSETTO gas al carburatore VESPA
Ø foro mm.1,6 - Ø barilotto esterno mm.4

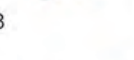

REGISTRI ESAGONALI con controdado per filo cambio HEXAGONALS ADJUSTMENTS with nut for gear cable

ART. **3592** M5 x 20

ART. **3578** M6 x 20

ART. **3593** M7 x 20



ART. **3596**

REGOLO (MODIFICATO)
filo freno e frizione

ADJUSTMENT (MODIFIED)
for brake and clutch wire

SCOOTER - APE



MORSETTI SERRAFILO - vite laterale CABLE CLAMPS - lateral screw

ART. **3520** Ø foro mm.2,7 - Ø barilotto est. mm.7

ART. **3522** Ø foro mm.3,4 - Ø barilotto est. mm.8

ART. **3524** Ø foro mm.4 - Ø barilotto est. mm.10



ART. **3595**

REGISTRO alla leva freno e frizione

ADJUSTEMENT for brake and clutch lever

CIAO - SI' e CICLOMOTORI VARI
(Sim. 103964)



VITI SCREWS

VITI TESTA ESAGONALE ZINCATE ZINCED SCREWS, HEXAGONAL HEAD

| CIF Art. | Dimensioni | Confezione |
|----------------|------------|------------|
| 3605-15 | M5 x 15 | 100 pz. |
| 3605-20 | M5 x 20 | 100 pz. |
| 3605-25 | M5 x 25 | 100 pz. |
| 3605-30 | M5 x 30 | 100 pz. |
| 3605-40 | M5 x 40 | 100 pz. |

| | | |
|----------------|---------|---------|
| 3606-10 | M6 x 10 | 100 pz. |
| 3606-15 | M6 x 16 | 100 pz. |
| 3606-20 | M6 x 20 | 100 pz. |
| 3606-25 | M6 x 25 | 100 pz. |
| 3606-30 | M6 x 30 | 100 pz. |
| 3606-40 | M6 x 40 | 100 pz. |

| | | |
|----------------|---------|---------|
| 3607-15 | M7 x 15 | 100 pz. |
| 3607-20 | M7 x 20 | 100 pz. |
| 3607-25 | M7 x 25 | 100 pz. |
| 3607-30 | M7 x 30 | 100 pz. |
| 3607-40 | M7 x 40 | 100 pz. |

| | | |
|----------------|---------|---------|
| 3608-15 | M8 x 15 | 50 pz. |
| 3608-20 | M8 x 20 | 100 pz. |
| 3608-25 | M8 x 25 | 50 pz. |
| 3608-30 | M8 x 30 | 50 pz. |
| 3608-35 | M8 x 35 | 50 pz. |

VITI TESTA CACCIAVITE ZINCATE ZINCED SCREWS, SCREWDRIVER HEAD

| | | |
|------------------|---|--|
| ART. 3101 | M3 x 30 TESTA CACCIAVITE (CONF.100 pz.) | |
|------------------|---|--|

| | | |
|---------------------|---|--|
| ART. 3105-15 | M5 x 15 TESTA CACCIAVITE (CONF.100 pz.) | |
|---------------------|---|--|

| | | |
|------------------|---|--|
| ART. 3106 | M6 x 30 TESTA CACCIAVITE (CONF.100 pz.) | |
|------------------|---|--|

| | | |
|------------------|---|--|
| ART. 3107 | M7 x 20 TESTA CACCIAVITE (CONF.100 pz.) | |
|------------------|---|--|

| | | |
|---------------------|--|--|
| ART. 3104-15 | M4 x 15 TESTA CROCE (per portatarga Scooter) (CONF. 50 pz.) | |
|---------------------|--|--|

VITI AUTOFILETTANTI SELF-THREADING SCREWS

| | | |
|------------------|--|--|
| ART. 5277 | mm. 2,9x13 - INOX TESTA CROCE SVASATA (CONF.100 pz.) | |
|------------------|--|--|

| | | |
|----------------------|--|--|
| ART. 5277-TCA | mm. 2,9x13 - INOX TESTA TAGLIO CACCIAVITE (CONF.100 pz.) | |
|----------------------|--|--|

| | | |
|------------------|--|--|
| ART. 5381 | mm.3,5x22 - INOX TESTA TAGLIO CACCIAVITE BOMBATA SOPRA SVASATA SOTTO TESTA (CONF.100 pz.) | |
|------------------|--|--|

| | | |
|------------------|--|--|
| ART. 3017 | mm. 3,5x25 NICHELATA/NICKEL TESTA CROCE (CONF.100 pz.) | |
|------------------|--|--|

| | | |
|------------------|---|--|
| ART. 3019 | mm.4,2x15 ZINCATA/ZINCED TESTA CROCE (CONF.100 pz.) | |
|------------------|---|--|

| | | |
|---------------------|---|--|
| ART. 5381-CO | mm.4,2x16 - INOX TESTA TAGLIO CACCIAVITE BOMBATA SOPRA SVASATA SOTTO TESTA (CONF.100 pz.) | |
|---------------------|---|--|

| | | |
|--------------------|--|--|
| ART. 5383-C | mm.4,8x13 TESTA CILINDRICA A CROCE fissa cuffia/copriventola VESPA (CONF.100 pz.) | |
|--------------------|--|--|

VITI TESTA CILINDRICA TAGLIO CACCIAVITE SCREWS, CYLINDRICAL SCREWDRIVER HEAD

fissa copriventola VESPA fino al 1981

| | | |
|----------------------|---------|--|
| ART. 3106-T10 | M6 x 10 | |
| ART. 3106-T12 | M6 x 12 | |
| ART. 3106-T16 | M6 x 16 | |

VITI TESTA CILINDRICA TAGLIO CROCE SCREWS, CYLINDRICAL CROSS HEAD

fissa copriventola VESPA dal 1982

| | | |
|----------------------|---------|--|
| ART. 3106-C10 | M6 x 10 | |
| ART. 3106-C12 | M6 x 12 | |
| ART. 3106-C16 | M6 x 16 | |



RONDELLE - DADI

WASHERS - NUTS

RONDELLE PIANE

PLAIN WASHERS

| CIF Art. | Dimensioni Dimensions | Confezione Package |
|----------------|--------------------------|-----------------------|
| 3124 | Ø mm. 4 | 100 pz. |
| 3125 | Ø mm. 5 | 100 pz. |
| 3126 | Ø mm. 6 | 200 pz. |
| 3127 | Ø mm. 7 | 100 pz. |
| 3128 | Ø mm. 8 | 100 pz. |
| 3129-10 | Ø mm.10 | 100 pz. |



RONDELLE GROWER

GROWER WASHERS

| CIF Art. | Dimensioni Dimensions | Confezione Package |
|----------------|--------------------------|-----------------------|
| 3125-GR | Ø mm. 5 | 100 pz. |
| 3126-GR | Ø mm. 6 | 100 pz. |
| 3127-GR | Ø mm. 7 | 100 pz. |
| 3128-GR | Ø mm. 8 | 100 pz. |
| 3129-GR | Ø mm. 9 | 100 pz. |
| 3130-GR | Ø mm.10 | 100 pz. |
| 3131-GR | Ø mm.12 | 100 pz. |



RONDELLE DENTELLATE

THOOTHED WASHERS

| CIF Art. | Dimensioni Dimensions | Confezione Package |
|----------------|--------------------------|-----------------------|
| 3124-DE | Ø mm. 4 | 100 pz. |
| 3125-DE | Ø mm. 5 | 100 pz. |
| 3126-DE | Ø mm. 6 | 100 pz. |
| 3127-DE | Ø mm. 7 | 100 pz. |
| 3128-DE | Ø mm. 8 | 100 pz. |



DADI AUTOBLOCCANTI

SELF-LOCKING NUTS

| CIF Art. | Dimensioni Dimensions | Confezione Package |
|-----------------|--------------------------|-----------------------|
| 3115-A | M 5 | 100 pz. |
| 3116-A | M 6 | 100 pz. |
| 3117-A | M 7 | 100 pz. |
| 3118-A | M 8 | 100 pz. |
| 3110-M10 | M 10 | 50 pz. |
| 3110-M12 | M 12 | 50 pz. |



DADI NORMALI

NORMAL NUTS

| CIF Art. | Dimensioni Dimensions | Confezione Package |
|-------------|--------------------------|-----------------------|
| 3109 | M 3 | 100 pz. |
| 3114 | M 4 | 100 pz. |
| 3115 | M 5 | 100 pz. |
| 3116 | M 6 | 100 pz. |
| 3117 | M 7 | 100 pz. |
| 3118 | M 8 | 100 pz. |



ART. 3110-ST

DADO MODELLO ORIGINALE **STONDATO**
M10x1,5 - h 9 - CHIAVE 14
ZINCATO BIANCO PER VITE FISSA MANUBRIO

*NUT ORIGINAL MODEL M10x1,5 - h9 - KEY 14
WHITE ZINCED FOR SCREW FIX HANDLEBAR*

VESPA 125 DAL 1961 AL 1966 (VNB3T->VNB6T)
VESPA 150 (VB1) - (VBA-VBB1/2)
VESPA GS 150 - GS 160

(Sim.012030)



ART. 3119

DADO M 9 - BASSO/LOW h mm.5

(Sim. 0020109)

PER ATTACCO AMMORTIZZATORI POSTERIORI
FOR SCREW SEC LOWER REAR SHOCK ABSORBERS

VESPA

(Conf./Pack.100 pz.)



ART. C00151

DADO QUADRO M 5

(Sim. 001565)

PER FASCETTA DEPURATORE ARIA
NUT FOR CLAMP SEC. AIR CLEANER

CIAO - BRAVO - Sì

(Conf./Pack.100 pz.)



PIASTRINE PER VITI

PLATES



ART. **10374** PIASTRINA PER VITE AUTOFILETTANTE Ø mm. 2,9 (Sim.S8088)

PER FISSAGGIO CLACSON
 PLATE FOR SELF-TAPPING SCREW FOR FIX HORN
 VESPA 50-N-L-R - PRIMAVERA 125 - GL - SUPER 125-150-SS180
 VESPA GT 125-SPRINT 150-RALLY 180-200 - T5 125

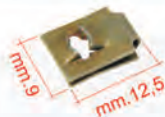

ART. **10375** PIASTRINA PER VITE AUTOFILETTANTE Ø mm. 3,5 (Sim.CM017403)

PER FISSAGGIO BORDO SCUDO INFERIORE
 PLATE FOR SELF-TAPPING SCREW FOR FIX BOARD SHIELD LOWER END
 VESPA LX - LX FL 2T/4T 50-125-150-VESPA S 2T/4T 50-125-150
 APPLICAZIONI VARIE / VARIOUS APPLICATIONS:
 BEVERLY-FLY-FREE-LYBERTY-NRG-SKIPPER-X9-ZIP - PORTER



ART. **10376** PIASTRINA PER VITE AUTOFILETTANTE Ø mm. 4,2 (Sim.CM017410 184142)

APPLICAZIONI VARIE
 PLATE FOR SELF-TAPPING SCREW FOR VARIOUS APPLICATIONS:
 BEVERLY-CARNABY-FLY-FREE-HEXAGON-LIBERTY-MP3-NRG-SFERA-SKIPPER
 VESPA ET2-ET4-GRANTURISMO-GTS-GTV-LX-VESPA S 2T/4T-X EVO-X7-X8-X9
 ZIP-TYPHOON - APE CALESSINO-CAR-MP601-POKER BENZINA/DIESEL



ART. **10377** PIASTRINA BRUNITA PER VITE AUTOFILETTANTE Ø mm. 4,2 (Sim.CM017409 185802)

APPLICAZIONI VARIE
 PLATE FOR SELF-TAPPING SCREW FOR VARIOUS APPLICATIONS:
 BEVERLY-CARNABY-FLY-LIBERTY-MP3-NRG - VESPA GRANTURISMO-GTS
 VESPA LX-S 2T/4T-X EVO - X7 - X8 - X9 EVOLUTION-ZIP 2T/4T - APE TM D LCS

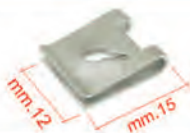

ART. **10373** PIASTRINA PER VITE AUTOFILETTANTE Ø mm. 4,8 (Sim.008112)

FISSA CUFFIA/COPRIVENTOLA
 PLATE FOR SELF-TAPPING SCREW, SEC. FAN COVER
 VESPA 50-90-125 PRIMAVERA-ET3 - PK



ART. **10378** PIASTRINA PER VITE PASSO M6 (Sim.254485)

APPLICAZIONI VARIE
 PLATE FOR SCREW M6 FOR VARIOUS APPLICATIONS:
 BEVERLY- CARNABY-DIESEL-FLY-FREE - HEXAGON - LIBERTY-MP3-NRG-NTT
 SFERA-SKIPPER-SKR-VESPA GRANTURISMO - LX/LXV- S 2T/4T
 X EVO-X7-X8-X9-ZIP-APE RST MIX - POKER BENZINA-TM D LCS PORTER

CONTENITORI PER MINUTERIA

SMALL PARTS BOXES



ART. **3065**
 CONTENITORE CON COPERCHIO
 (N.16 scomparti fissi) (dimensioni cm. 24 x 18 x 4)
 per minuteria in genere (viti-getti.....)

BOX WITH COVER
 (No. 16 fixed compartments) (dimensions cm. 24 x 18 x 4)
 for small parts (screws, jets, bolts, nuts)



ART. **3066**
 CONTENITORE CON COPERCHIO
 (N.10 scomparti fissi) (dimensioni cm. 24 x 18 x 4)
 per minuteria in genere (viti-getti.....)

BOX WITH COVER
 (No. 10 fixed compartments) (dimensions cm. 24 x 18 x 4)
 for small parts (screws, jets, bolts, nuts)



DECORAZIONI ADESIVE
ADHESIVE DECORATIONS

WHEEL STRIPE CON APPLICATORE
WITH APPLICATOR



Decorazione adesiva per cerchi moto ed altre applicazioni.
Una confezione è sufficiente per la decorazione di una coppia di cerchi da 19" su entrambi i lati.

*Decoration adhesive for rims and others applications.
A Package is sufficient for decoration a couple of rims 19" on both sides*

RINFRANGENTE / REFRACTIVE



ART. **3400-A**

RINFRANGENTE / REFRACTIVE
BIANCO / WHITE
(5 mm. x 6 mt.)



ART. **3401-A**

RINFRANGENTE / REFRACTIVE
ROSSO / RED
(5 mm. x 6 mt.)



ART. **3402-A**

RINFRANGENTE / REFRACTIVE
BLU / BLUE
(5 mm. x 6 mt.)

FLUORESCENTE / FLUORESCENT



ART. **3410-A**

FLUORESCENTE / FLUORESCENT
GIALLO / YELLOW
(5 mm. x 6 mt.)



ART. **3411-A**

FLUORESCENTE / FLUORESCENT
ROSSO / RED
(5 mm. x 6 mt.)

DECORAZIONI ADESIVE
ADHESIVE DECORATIONS

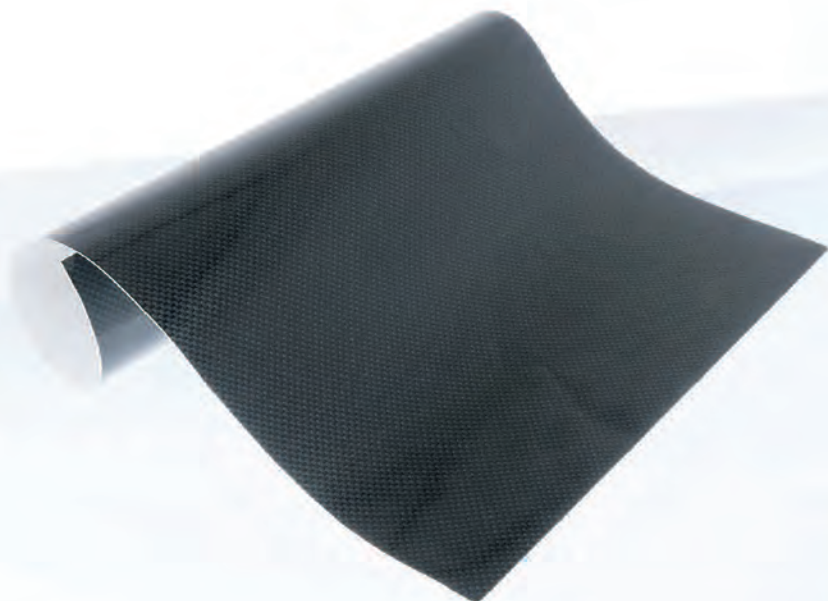

ART. **3496**
CARBON PAPER
(Foglio adesivo cm. 34x48)



ART. **3486**
SCUDETTO 3D RESINATO ADESIVO
RESINED ADHESIVE 3D EMBLEM



ART. **3457**
KIT ADESIVI APRILIA RACING
(Foglio cm.20x24)
SCOOTER-MOTO-AUTO-CASCHI



ART. **3423**
KIT ADESIVI
(Foglio cm.20x24)
SCOOTER-MOTO-AUTO - CASCHI



DECORAZIONI ADESIVE
ADHESIVE DECORATIONS



ART. **3380**

SR. COMPLETA FREGI PER SACCHE E PARAFANGO

COMPLETE SET OF ADHESIVE ORNAMENTS
FOR BODY SIDES AND MUDGUARD

VESPA 125 PRIMAVERA ET3

(Sim. 610194M)

PROTEZIONE SERBATOIO
TANK PROTECTION



ART. **3490-R**

PROTEZIONE SERBATOIO

mm. 130 x h200

modello CARBONIO resinato
CARBON resin model



ART. 2062

MASTICE ROSSO / RED MASTIC 555

Mastice al silicone auto-vulcanizzante resistente da -70° a +280° di temperatura. Indicato per formare guarnizioni di vari spessori o per sostituire qualsiasi tipo di guarnizioni tradizionale. Particolarmente consigliato per motori da competizione o soggetti a forti sollecitazioni.

It is ideal for oil pans, housing distribution, differentials, etc. It is insoluble in gasoline, glycols and water. Withstands temperatures from -70°C. to +280°C.

Tubetto da 75 ml.



ART. 2063

MASTICE NERO / BLACK MASTIC 666

Mastice al silicone auto-vulcanizzante resistente da -70° a +250° di temperatura. Indicato per formare guarnizioni di vari spessori o per sostituire ogni tipo di guarnizione tradizionale. Permette il riempimento di sottili fessure e leggere imperfezioni dei piani da unire. Particolarmente consigliato per coppe olio-carter di distribuzione-differenziali.

It is ideal for oil pans, housing distribution, differentials, etc. It is insoluble in gasoline, glycols and water. Withstands temperatures from -70°C. to +250°C.

Tubetto da 75 ml.



ART. 2060

ERMETICO LIQUIDO

PAPER GASKETS BOSTICK
with small brush

Flacone da 125 ml.
con pennellino I with small brush

Sigillante semi-liquido a base di resine naturali con alto potere adesivo. Resistente ad alte temperature e pressioni. Indicato per quarazioni in carta di carter - coppe olio etc. ...

Semi-liquid sealant based on natural resins with high adhesive power. Resistant to high temperatures and pressures. Suitable for carter's paper seals - oil sumps etc. ...



ART. 2064

SIGILLANTE VERDE

GREEN SEALANT

Flacone da 50 ml.

Adesivo anaerobico per sigillare superfici piane e giunzioni flangiate di pompe, scatole ingranaggi, cambi, differenziali, flange di motori. Forma un film elastico, resistente alle vibrazioni, al calore da -50° a + 150°, agli oli e fluidi industriali, gas, GPL, idrocarburi, acqua.

Anaerobic adhesive for sealing flat surfaces and flanged joints of pumps, gearbox, transmissions, differentials, engine flanges. It forms an elastic film resistant to vibration, heat from -50° to + 150°, oil, gas, GPL, hydrocarbons and water.



PRODOTTI PER L'OFFICINA
WORKSHOP PRODUCTS



ART. **2066**

SERRAFILETTI / THREADLOCKING

Adesivo per metalli ideale per frenare giunzioni filettate, per bloccare bulloni, dadi, viti. Resiste a sbalzi termici e forti vibrazioni.

It ensures the locking of screws, nuts and studs. It prevents loosening caused by vibrations. It allows easy removal.

Flacone da 10 ml.



ART. **2065**

SPRAY RIMUOVI GUARNIZIONI ED ETICHETTE

GASKET REMOVED SPRAY

Bomboletta da 400 ml.

Rimuove ed elimina velocemente gomme, colle, mastici e vecchie guarnizioni; è particolarmente indicato per l'asportazione dell'adesivo di etichette.

Prima di spruzzare su superfici verniciate o di plastica, controllare la resistenza delle stesse al solvente contenuto.

It removes and eliminates quickly rubber, adhesives, putty and gaskets. It is ideal to remove adhesive labels. It evaporates quickly.



ART. **2081**

SPRAY PULITORE CONTATTI ELETTRICI ED ELETTRONICI

CONTACTS ELECTRICAL AND ELETRONIC CLEANER SPRAY

Bomboletta da 400 ml.

Permette la pulizia di componenti elettrici, contatti elettronici, testine audio e video, connessioni HiFi.

Rimuove ossidazioni, unto e sporco senza lasciare residui; non corrode i metalli.

It allows the cleaning of electrical components, eletronic contacts, audio and video heads, HiFi connections. It removes oxidation, grease and dirt, without leaving residues; it doesn't corrode metals.



ART. **2082**

LAVAMOTORI E SGRASSANTE SPRAY
SPRAY ENGINE WASHER

Bomboletta da 400 ml.

Sgrassa e pulisce catene di trasmissione-corone motori e parti meccaniche in genere (non danneggia i particolari in gomma)

It quickly de-greases and cleans engines, chains and mechanical parts.



ART. **2080**

SBLOK

Bomboletta da 400 ml.

Spray sbloccante, disossidante, scioglie ruggine Non intacca metalli e vernici, protegge dalla corrosione.

Ideal to release, lubricate and unoxidize screws, nuts, bolts, pivots and mechanical parts. It does not damage metals and varnish, it protects from corrosion.



PRODOTTI PER L'OFFICINA
WORKSHOP PRODUCTS



ART. 2098

GRASSO PER IMPIEGHI GENERICI
GENERIC GREASE

barattolo da 250 ml.



ART. 2099

GRASSO AL LITIO
LITHIUM GREASE

(specifico x cuscinetti a sfera, snodi, articolazioni, ingranaggi,)

barattolo da 250 ml.



ART. 2076

GRASSO SPRAY
SPRAY GREASE

protegge e lubrifica tutti i tipi di catene, cuscinetti e lubrificazione in genere

bombola da 400 ml.



ART. 2077

GRASSO SILICONICO
SILICONE GREASE

tubetto da 100 ml.



ART. 2078

GRASSO AL RAME
RESISTE A TEMPERATURE
da -30°C a +1100°C
COPPER GREASE
RESISTANT TO TEMPERATURES
FROM -30°C a +1100°C

Ideale per perni di collettori scarico motore, giunti ad espansione ed a flangia, protezione per contatti elettrici, viti a cerniera, valvole d'iniezione, testate motori diesel, raccordi filettati.

It is ideal for pins of engine exhaust collectors, expansion joints and flanged joints, electrical contacts protection, hinge screws, injector valves of cylinder head, threaded fittings.

tubetto da 75 ml.



ART. 2079

GRASSO VASELLINA BIANCA FILANTE
WHITE VASELINE GREASE

Formulato per essere impiegato sui morsetti degli accumulatori e nell'impianto elettrico in genere: elimina l'ossidazione, le dispersioni di corrente ed impedisce la solfatazione. E' impermeabile all'acqua.

It can be used on batteries terminals and in electrical system in general: it eliminates oxidation and current leakage. It is waterproof.

tubetto da 75 ml.



PRODOTTI PER L'OFFICINA WORKSHOP PRODUCTS



ART. **2118**

ANTIWEAR MOTOR OIL

Prodotto professionale esente da particelle solide studiato per migliorare le prestazioni antiusura ed antiattrito degli oli motore; compatibile sia con gli oli motore a base minerale che a base sintetica. Utilizzabile con tutti i sistemi di abbattimento dei gas di scarico. Diminuisce la rumorosità delle punterie idrauliche e non, l'attrito e l'usura tra le parti meccaniche e gli organi in movimento, i consumi sia dell'olio che del carburante. Ripristina le compressioni, riduce le emissioni inquinanti, favorisce la pulizia del motore. Esente da piombo e cloro, non intasa né filtro né fori di passaggio dell'olio. Può essere utilizzato sia in aggiunta che dopo il cambio d'olio, aggiungendolo direttamente all'olio motore. **Utilizzabile sin dal primo cambio d'olio, agisce sino al successivo cambio dell'olio.**

Professional product to improve the antifriction and anti-wear performance of engine oil. It is compatible with mineral and synthetic engine oils; it decreases fuel and oil consumption, the noisiness, the friction between mechanical parts and the wear of moving parts; it reduces pollutant emission. Add directly in the engine oil, in addition or after the change.

Barattolo da 250 ml.



ART. **2120**

LIQUIDO RADIATORI da -20° A 118°

PROTETTIVO ANTICONGELANTE INIBITO BLU

SPECIFICO PER MOTORI DI NUOVA GENERAZIONE

Protettivo anticongelante per circuiti di raffreddamento di auto, moto e veicoli industriali. E' compatibile con liquidi di primo impianto e con ogni tipo di antigelo e liquido permanente. La particolare inibizione evita l'indurimento ed il rigonfiamento dei manicotti e delle guarnizioni. Previene la corrosione e la formazione di ruggine ed incrostazioni calcaree nel circuito del motore. Impedisce la creazione di fenomeni di cavitazione della pompa dell'acqua.

Rispondente alle norme: ASTM D3306; ASTM D1384; ASTM D2570

Flacone 1 Kg.



ART. **2122**

LIQUIDO RADIATORI da -20° A 118°

PROTETTIVO ANTICONGELANTE INIBITO ROSSO

SPECIFICO PER MOTORI DI NUOVA GENERAZIONE

Protettivo anticongelante per circuiti di raffreddamento di auto, moto e veicoli industriali. E' compatibile con liquidi di primo impianto e con ogni tipo di antigelo e liquido permanente. La particolare inibizione evita l'indurimento ed il rigonfiamento dei manicotti e delle guarnizioni. Previene la corrosione e la formazione di ruggine ed incrostazioni calcaree nel circuito del motore. Impedisce la creazione di fenomeni di cavitazione della pompa dell'acqua.

Rispondente alle norme: ASTM D3306; ASTM D1384; ASTM D2570

Flacone 1 Kg.



ART. **2070-T**

VERNICE SPRAY TRASPARENTE (ALTA TEMPERATURA)

IDEALE PER MARMITTE - TUBI SCARICO - MOTORI - CARTER RADIATORI
RESISTE A TEMPERATURA FINO 800°C

*SPRAY TRANSPARENT VARNISH FOR EXHAUST (HIGH TEMPERATURE)
IDEAL FOR ENGINE CARTERS, RADIATORS, WASTE PIPES.
IT RESISTS UP TO 800°C*

Bombola da 400 ML.



ART. **2070-N**

VERNICE SPRAY NERA (ALTA TEMPERATURA)

IDEALE PER MARMITTE - TUBI SCARICO - MOTORI - CARTER - RADIATORI
RESISTE A TEMPERATURA FINO 800°C

*SPRAY BLACK PAINT FOR EXHAUST (HIGH TEMPERATURE)
IDEAL FOR ENGINE CARTERS, RADIATORS, WASTE PIPES.
IT RESISTS UP TO 800°C*

Bombola da 400 ML.



ART. **2050**

GONFIA E RIPARA PNEUMATICI

PUMP E REPAIR FOR TYRE

Bombola da 300 ML.

Ripara e gonfia istantaneamente il pneumatico forato con e senza camera d'aria.

It repairs and inflates the perforated tyre.



ART. **2095**

LUCIDANTE PER CROMATURE

PLATING POLISH

Barattolo da 250 ml.

Lucida e protegge cromature, metalli lucidi, acciaio inox ed alluminio. Preserva dalla ruggine e dall'ossidazione.

It polishes and renovate platings, glossy metals, steel and anodized aluminum.



ART. **2094**

TOGLI GRAFFI PER CARROZZERIA

SCRATHES REMOVER FOR BODYWORKS

Tubetto da 100 gr.

La particolare formulazione consente al prodotto di eliminare segni, graffi, rigature superficiali e residui di gomma o vernice provocati da piccoli urti e sfregamenti contro altre superfici senza intaccare lo strato trasparente di vernice. Indicato anche per vernici metallizzate; ridona la lucentezza originale preservandola dall'ossidazione.



PRODOTTI PER PULIZIA
CLEANING PRODUCTS



ART. **2110**

PELLE NATURALE SCAMOSCIATA
NATURAL LEATHER

Pelle naturale scamosciata ideale per asciugare e pulire delicatamente carrozzerie, vetri, cruscotti, interni auto, etc....
Completamente rifinita a mano, è conciata con i più avanzati metodi che la rendono resistente e duratura all'uso prolungato.

Ideal for cars, boats, hove, glasses, etc....

Taglia media 2,0 p.d.



ART. **2130**

SHAMPOO LAVAGGIO AUTO

Detergente liquido ad alta concentrazione per il lavaggio di carrozzerie degli autoveicoli, camper, veicoli industriali e motocicli. Il prodotto è ideale anche per vernici metallizzate. Pulisce a fondo ridonando brillantezza alle parti trattate.

Flacone 1 Lt.



ART. **2102**

CREMA LAVAMANI BIANCA
WHITE HANDWASH CREAM

Secchiello da 4 lt.



ART. **2104**

PASTA LAVAMANI TRADIZIONALE
HANDWASH PASTE

Secchiello da 1 lt.



ART. **2105**

LAVAMANI PROFESSIONALE
PROFESSIONAL HANDWASH

Flacone 500 ml. con dispenser

MODELLO TRIAL



ART. **10229**

COMANDO PORTA LEVA SINISTRO
CON LEVA IN ALLUMINIO NERO

CONTROL HOLDER LEVER (LEFT)
WITH BLACK ALUMINUM LEVER



ART. **10230**

COMANDO PORTA LEVA DESTRO
CON LEVA IN ALLUMINIO NERO

CONTROL HOLDER LEVER (RIGHT)
WITH BLACK ALUMINUM LEVER

**MALAGUTI 50 ENDURO - APRILIA ETX 50
FANTIC OASI 50 - GARELLI RAIDER 50**



ART. **10232**

LEVA FRIZIONE IN ALLUMINIO VERNICIATA NERA
CLUTCH LEVER, BLACK PAINTED IN ALUMINUM

(RICAMBIO PER / SPARE FOR : CIF ART. 10229)

ANCHE PER / ALSO FOR: **PEUGEOT XP6 2000**



ART. **10233**

LEVA FRENO IN ALLUMINIO - VERNICIATA NERA
BRAKE LEVER, BLACK PAINTED IN ALUMINUM

(RICAMBIO PER / SPARE FOR : CIF ART. 10230)

CICLOMOTORI - MOTO / MOPEDS AND MOTORCYCLES



ART. **10260**

LEVA DI DECOMPRESSIONE (ALZAVALVOLA)
FISSAGGIO CON FASCETTA AL MANUBRIO

DECOMPRESSION LEVER (VALVE LIFTERS)
FIXING WITH LEVER TO HANDLEBAR



ART. **10261**

COMANDO STARTER
FISSAGGIO CON FASCETTA AL MANUBRIO

CONTROL STARTER
FIXING WITH LEVER TO HANDLEBAR



COMANDI GAS
THROTTLE CONTROLS



NEW GRIPS



ART. **10253**

COMANDO GAS RAPIDO COMPLETO CON MANOPOLE
THROTTLE CONTROL WITH GRIPS

MODELLO DOMINO "COMMANDOS"

CORSA MAX mm.42 (mm.36/79°)

STRADALI - CICLOMOTORI - MOTO - TRIAL



ART. **10258**

COMANDO GAS RAPIDO SENZA MANOPOLE
THROTTLE CONTROL WITHOUT GRIPS

MODELLO DOMINO "COMMANDOS"

CORSA MAX mm.42 (mm.36/79°)

STRADALI - CICLOMOTORI - MOTO - TRIAL



ART. **10252**

COMANDO GAS COMPLETO DI MANOPOLE
THROTTLE CONTROL WITH GRIPS

MODELLO DOMINO "ENDROSS"

VERSIONE CROSS (mm. 36/67°)
VERSIONE ENDURO (mm. 36/78°)

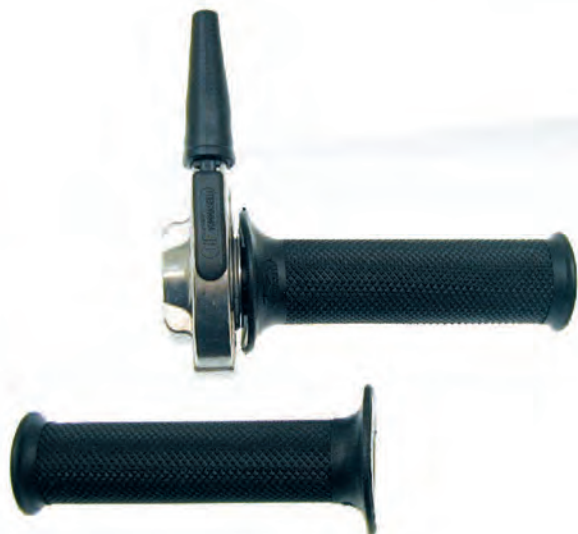

ART. **10211**

COMANDO GAS COMPLETO DI MANOPOLE
THROTTLE CONTROL WITH GRIPS

MODELLO TOMMASELLI " MOD. HF CROMATO "

CORSA / STROKE MAX mm.46 (mm.36/80°)

CROSS E STRADALI



ART. **10212**

COMANDO GAS COMPLETO DI MANOPOLE
THROTTLE CONTROL WITH GRIPS

MODELLO TOMMASELLI " FORMULA "

CORSA / STROKE MAX mm. 47 (mm.36/75°)

(COPERCHIETTO RINVIO TRASPARENTE)

CROSS E STRADALI



ART. **10210**

COMANDO GAS SENZA MANOPOLE
THROTTLE CONTROL WITHOUT GRIPS

MODELLO TOMMASELLI " FORMULA "

CORSA / STROKE MAX mm. 47 (mm.36/75°)

(COPERCHIETTO RINVIO TRASPARENTE)

CROSS E STRADALI



COMANDI GAS THROTTLE CONTROLS



ART. **10232-G**

COMANDO GAS COMPLETO DI MANOPOLE
THROTTLE CONTROL WITH GRIPS

MODELLO DOMINO

CORSA / STROKE (mm.36/90°)
CORSA / STROKE (mm.36/120°)

STRADALI - TRIAL

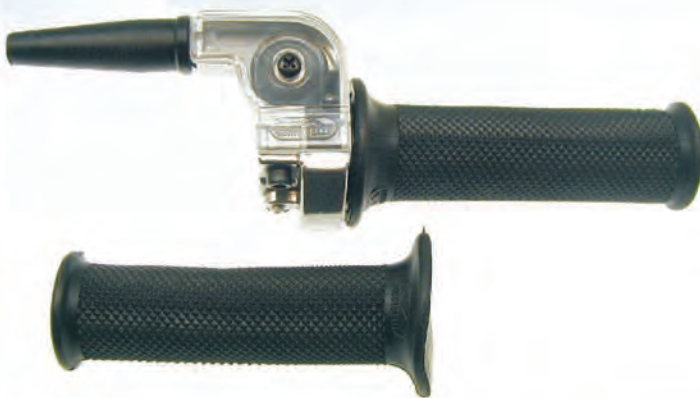

ART. **10213**

COMANDO GAS COMPLETO DI MANOPOLE
THROTTLE CONTROL WITH GRIPS

MODELLO TOMMASELLI " MOD. MOPED "

CORSA / STROKE MAX mm.46 (mm.36/148°)
(COPERCHIETTO RINVIO TRASPARENTE)

CROSS E STRADALI



ART. **10215**

COMANDO GAS RAPIDO COMPLETO DI MANOPOLE
THROTTLE CONTROL WITH GRIPS

MODELLO " GHEPARD "

CORSA / STROKE MAX mm. 45
(COPERCHIETTO RINVIO INOX)

SCOOTER - STRADALI



ART. **10241**

CP. MANOPOLE NERE / BLACK

(SIM. 267205+267206)

PIAGGIO SI' FL
SCOOTER SFERA BASE 50



RICAMBIO PER
SPARE FOR:
CIF ART. 10208 / 10218

ART. **10207**

CP. MANOPOLE IN GOMMA NERA / BLACK RUBBER

LUNGHEZZA / LENGHT mm. 114 - Ø mm. 22-24

PIAGGIO CIAO - SI' FINO AL 1988



RICAMBIO PER
SPARE FOR:
CIF ART. 10239 / 10240

ART. **10238**

CP. MANOPOLE IN GOMMA NERA / BLACK RUBBER

LUNGHEZZA / LENGHT mm. 122 - Ø mm. 22-24

PIAGGIO CIAO - SI' DAL 1988 AL 1992



ART. **10301**

COPPIE MANOPOLE IN PARA

MODELLO "RETRO"

STRADALI - SCOOTER



COPPIE MANOPOLE PAIR GRIPS



ART. **10290**

COPPIA MANOPOLE **ESTREMITA' FORATE / OPEN END**

LUNGHEZZA COMPLESSIVA / TOTAL LENGHT mm.127

PIAGGIO:
BEVERLY 200 ('04-'05) - BEVERLY EU3 250 ('06-'07) - LIBERTY 150 4T ('08->)
MP3 125 ('07->) - VESPA GTS 125-200 ('06->) - X7 125 IE 125 ('08->)
X8 PREMIUM EU3 125 ('06->) - X8 200-250 ('05->) - X9 200('03->)
X9 EVOLUTION125 ('05->) - X9 EVOLUTION 250 ('06->) - X EVO 125 ('08->)

GILERA: RUNNER 180 (->'01)-VXR 4T 180 ('01->) -VXR 200 ('05->)

SI ABBINA AL TUBO COMANDO GAS
FOR THROTTLE CONTROL CIF ART. 10346



ART. **10243**

CP. MANOPOLE NERA FUSTELLATA **ESTREMITA' FORATE / OPEN END**

LUNGHEZZA COMPLESSIVA / TOTAL LENGHT mm.120

MODELLO SCOOTER GP

PIAGGIO:
LIBERTY 4T EU3 DELIVERY-SINGLE 125 ('07-'15)
LIBERTY 4T EU3 DELIVERY TNT-NEXIVE 125 ('08-'15)
LIBERTY ELETTRICO PPT AUT. ('11) - LIBERTY RST PTT 125 ('05-'11)



ART. **10291**

COPPIA MANOPOLE

LUNGHEZZA COMPLESSIVA / TOTAL LENGHT mm.127
LUNGHEZZA INTERNA / INTERNAL LENGHT mm.122

PIAGGIO:
BEVERLY 125 ('04->) - BEVERLY TOURER EU3 125 ('08->) - CARNABY 125 ('07->)
CARNABY 200('07->) - FLY 125 ('05-'07) - LIBERTY 2T/4T 50('05) - LIB.125 ('04-'08)
LIBERTY ST 200('04) - LIBERTY 4T 200 ('07) - NRG 50 ('02->)
VESPA ET2 50 ('97->) - VESPA ET4 125 ('96->)

GILERA TYPHOON 50 ('05->)

SI ABBINA AL TUBO COMANDO GAS
FOR THROTTLE CONTROL CIF ART. 10347



ART. **10272**

COPPIA MANOPOLE

LUNGHEZZA COMPLESSIVA / TOTAL LENGHT mm.118
LUNGHEZZA INTERNA / INTERNAL LENGHT mm.112

PIAGGIO
FLY 50 4T ('06->) - FLY 100 ('04->) - LIBERTY 4T EU3 125 ('06-'08) - 4T EU3 150('08)
LIBERTY 4T 2V EU3 125 ('09-'12) - SPORT 4T EU3 125('06-'08) - SPORT 4T EU3 150 ('08)
LIBERTY MOC 4T EU3 150 ('09-'13) - VESPA LX 125/150 ('05-'06) - LX 2T 50 ('05-'13)
VESPA LX 2T TOURING & 30 KM. 50 ('10-'13) - LX 4T 50 ('05-'09) - LX 4T-4V 50 ('09-'13)
VESPA LX 4T-4V & COLLEGE 50 ('08-'12)-LX 4T-4V TOURING 50 ('10-'13)-LX EU3 125/150 (06-08)
VESPA LX 4T EU3 IE 125/150 ('09-'11) - LX TOURING 4T EU3 125 ('10-'11)
VESPA LX TOURING 150 ('10-'12) - LX TOURING 4T 3V IE 150 ('12-'13) - LX FL 4T 125/150 ('09)
VESPA S 2T & COLLEGE 50 ('07-'12) - S 4T-4V & COLLEGE 50 ('08-'12)- S 4T EU3 125 ('07-'08)
VESPA S 4T IE & COLLEGE 125 ('09-'11) - S 4T IE & COLLEGE 150 ('09-'12)

GILERA STALKER 50 ('04->)

SI ABBINA AL TUBO COMANDO GAS
FOR THROTTLE CONTROL CIF ART. 10348



ART. **10293**

CP. MANOPOLE IN GOMMA NERA **ESTREMITA' FORATE**
PAIR GRIPS IN BLACK RUBBER WITH **OPEN END**

LUNGHEZZA / LENGHT **mm. 120** - Ø mm. 20/24

RIGATURA DISEGNO "**HONDA**"

SCOOTER HONDA SH 150 - 300



ART. **10510**

CP. MANOPOLE IN GOMMA EXTRA SOFT
TERMOPLASTICA NERA **ESTREMITA' FORATE**
PAIR GRIPS IN BLACK EXTRA SOFT RUBBER COMPOUND
WITH **OPEN END**

LUNGHEZZA / LENGHT **mm. 120** - Ø mm.20/24

RIGATURA DISEGNO "**YAMAHA**"

YAMAHA T-MAX - X-MAX - STRADA R6/R1 FINO AL / TILL TO 2012)



ART. **10515**

CP. MANOPOLE IN GOMMA TERMOPLASTICA NERA
PAIR GRIPS IN BLACK RUBBER COMPOUND

LUNGHEZZA / LENGHT **mm. 120** - Ø mm. 20/24

SCOOTER KYMCO - HONDA - PEUGEOT - PIAGGIO - YAMAHA



COPPIE MANOPOLE

PAIR GRIPS



ART. 10516

CP. MANOPOLE IN GOMMA TERMOPLASTICA NERA
ESTREMITA' FORATE

PAIR GRIPS IN BLACK RUBBER COMPOUND WITH **OPEN END**

LUNGHEZZA / LENGHT **mm. 120** - Ø mm. 20/24

SCOOTER KYMCO - HONDA - PEUGEOT - PIAGGIO - YAMAHA



ART. 10519

CP. MANOPOLE IN GOMMA TERMOPLASTICA NERA
PAIR GRIPS IN BLACK RUBBER COMPOUND

LUNGHEZZA / LENGHT **mm. 128** - Ø mm. 20/24

MODELLO "**DAKAR**"

SCOOTER - MOTO



ART. 10520

CP. MANOPOLE IN GOMMA TERMOPLASTICA NERA
ESTREMITA' FORATE

PAIR GRIPS IN BLACK RUBBER COMPOUND WITH **OPEN END**

LUNGHEZZA / LENGHT **mm. 128** - Ø mm. 20/24

MODELLO "**DAKAR**"

SCOOTER - MOTO

**COPPIE MANOPOLE RACING XM2 SCOOTER E MOTO STRADALI
IN GOMMA MORBIDA - ESTREMITA' FORATE**

XM2 DOUBLE SUPER SOFTS GRIPS IN RUBBER COMPOUND, OPEN END

LUNGHEZZA / LENGHT mm. 126



ART. **10298-R**

CP. MANOPOLE **ESTREMITA' FORATE**
PAIR GRIPS WITH **OPEN END**

LUNGHEZZA / LENGHT **mm. 126**

COLORE NERO/ROSSO / *BLACK/RED COLOUR*



ART. **10298-B**

CP. MANOPOLE **ESTREMITA' FORATE**
PAIR GRIPS WITH **OPEN END**

LUNGHEZZA / LENGHT **mm. 126**

COLORE BLU/BIANCO / *BLUE/WHITE COLOUR*



ART. **10298-N**

CP. MANOPOLE **ESTREMITA' FORATE**
PAIR GRIPS WITH **OPEN END**

LUNGHEZZA / LENGHT **mm. 126**

COLORE NERO/GRIGIO / *BLACK/GREY COLOUR*



COPPIE MANOPOLE PAIR GRIPS



COPPIE MANOPOLE RACING MOTO STRADALI IN GOMMA TERMOPLASTICA - ESTREMITA' FORATE

ROAD RACING GRIPS IN RUBBER COMPOUND, OPEN END

LUNGHEZZA / LENGHT mm. 126



ART. **10300-R**

CP. MANOPOLE **ESTREMITA' FORATE**

PAIR GRIPS WITH **OPEN END**

LUNGHEZZA / LENGHT mm. 126

COLORE NERO/ROSSO / BLACK/RED COLOUR



ART. **10300-N**

CP. MANOPOLE **ESTREMITA' FORATE**

PAIR GRIPS WITH **OPEN END**

LUNGHEZZA / LENGHT mm. 126

COLORE NERO/GRIGIO / BLACK/GREY COLOUR



ART. **10300-B**

CP. MANOPOLE **ESTREMITA' FORATE**

PAIR GRIPS WITH **OPEN END**

LUNGHEZZA / LENGHT mm. 126

COLORE BLU/BIANCO / BLUE/WHITE COLOUR

LUNGHEZZA / LENGHT mm. 120



ART. **10294**

CP. MANOPOLE IN GOMMA NERA

PAIR GRIPS IN BLACK RUBBER

LUNGHEZZA / LENGHT mm. 120 - Ø mm. 20/24

CROSS/ENDURO - ADATTABILE SU SCOOTER

POSTERIORI / REAR

AMMORTIZZATORI LAMBRETТА

LAMBRETTA SHOCK ABSORBERS

**IDRAULICI - DOPPIO EFFETTO
STRUTTURA ACCIAIO CON SALDATURE A INDUZIONE**

**HYDRAULIC - DOUBLE EFFECT
STRUCTURE STEEL WITH INDUCTION WELDS**

**MOLLA:
IN ACCIAIO TEMPERATO**

**SPRING:
TEMPERATED STEEL**



ART. **6295**

POSTERIORE
VERSIONE LUSO

CORPO NERO - MOLLA NERA

REAR, BLACK BODY - BLACK SPRING

INTERASSE / WHEELBASE mm. 320

LAMBRETTA LI 2ª SERIE



ART. **6298**

POSTERIORE VERSIONE ZINCATA
CORPO ZINCATO - MOLLA NERA

REAR, ZINCED VERSION - ZINCED BODY - BLACK SPRING

INTERASSE / WHEELBASE mm. 304

LAMBRETTA LI 3ª SERIE



ART. **6298-L**

POSTERIORE VERSIONE LUSO
CORPO NERO - MOLLA NERA

REAR, BLACK BODY - BLACK SPRING

INTERASSE / WHEELBASE mm. 304

LAMBRETTA LI 3ª SERIE



RICAMBI LAMBRETTA
LAMBRETTA SPARE PARTS

INNOCENTI

Lambretta



ART. **10015**

TARGHETTA LUNGHEZZA mm. 210
NAMEPLATE, LENGHT mm. 210

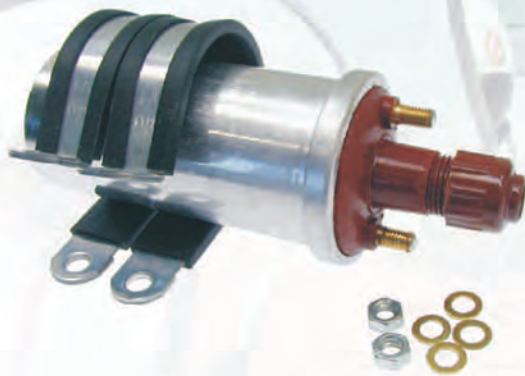

ART. **7073**

BOBINA ACCENSIONE ESTERNA
OUTSIDE H.T. COIL
LAMBRETTA LI 150
(Sim.326106)

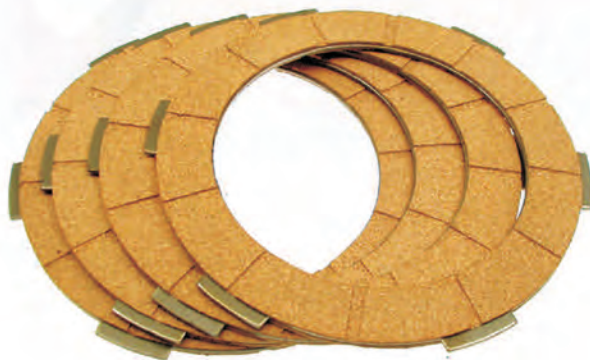

ART. **4015**

SERIE DISCHI FRIZIONE (Nr. 4 PZ.)
CLUTCH DISCS SET (No. 4 pcs)

LAMBRETTA LI



ART. **4430**

CROCERA INNESTO MARCE
SELECTOR SPIDER
LAMBRETTA LI 125 - 15'

ricambio originale
Lambretta

LAMBRETТА LI 2^a-3^a serie 125/150 cc.

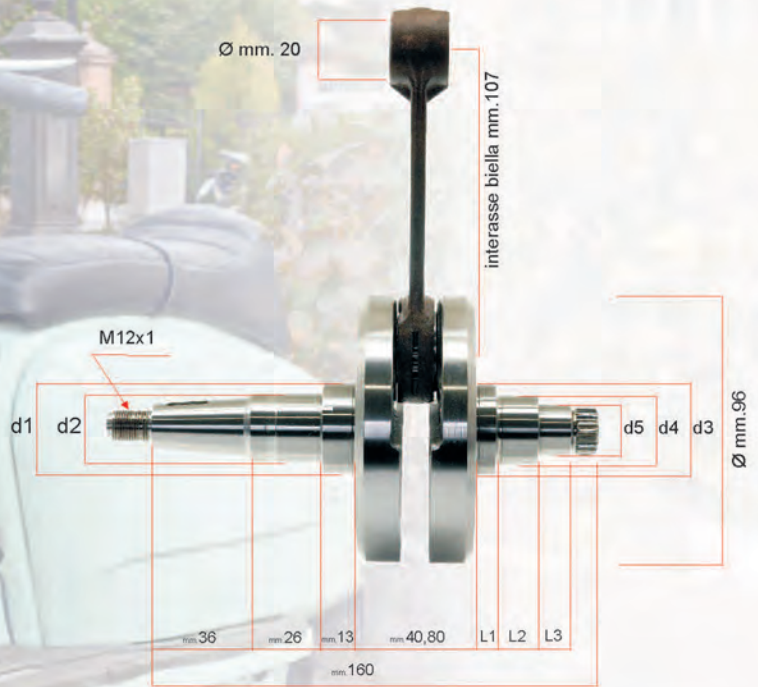

- d1= Ø mm.33
- d2= Ø mm.25
- d3= Ø mm.33
- d4= Ø mm.25
- d5= Ø mm.18,5

- L1= lunghezza mm.8
- L2= lunghezza mm.15
- L3= lunghezza mm.12



mazzucchelli
AMT 074

modello VERSIONE NORMALE (CORSA mm. 58)

ART. **10148**

ALBERO MOTORE
CORSA mm. 58
BIELLA INTERASSE mm. 107

CRANKSHAFT
STROKE mm. 58
CON-ROD WHEELBASE mm.107

LAMBRETТА LI 2^a-3^a SERIE 125/150





SR. GUARNIZIONI LAMBRETТА
LAMBRETТА ENGINE GASKETS SET



ART. **9326**
SERIE GUARNIZIONI MOTORE
LAMBRETТА LI 125

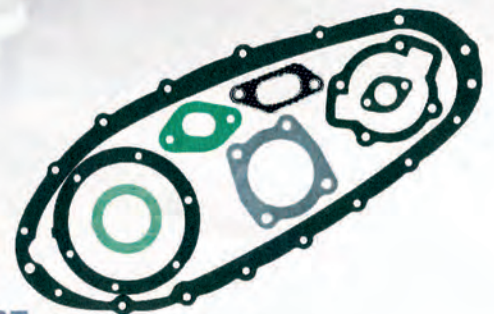

ART. **9327**
SERIE GUARNIZIONI MOTORE
LAMBRETТА LI 150

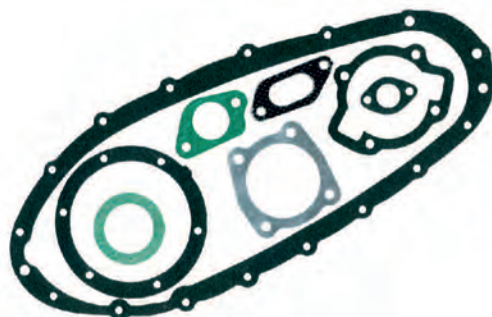

ART. **9328**
SERIE GUARNIZIONI MOTORE
LAMBRETТА 175

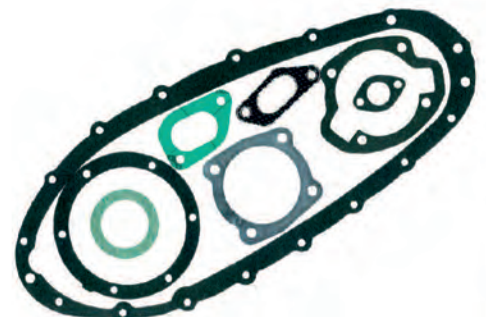

ART. **9329**
SERIE GUARNIZIONI MOTORE
LAMBRETТА 200

INNOCENTI

Lambretta

GANASCE - PASTIGLIE FRENO

BRAKE SHOES - BRAKE PADS



ANT. = FRONT
POST. = REAR



ART. **GF0089**

COPPIA GANASCE

INNOCENTI LAMBRETТА LI 125 ('58-'59) - LI I 150 ('58-'59)
LAMBRETТА LI II 125 ('59-'61) - LI II 150 ('59-'61)
LAMBRETТА LI III 125 ('61-'69) - LI III 150 ('61-'69)
LAMBRETТА SX 150 ('66-'69)
LAMBRETТА SX 200 ('66-'68)
LAMBRETТА TV I 175 ('57-'59) - TV II 175 ('59-'61)
LAMBRETТА TV III 175 ('62-'67) - TV III 200 ('63-'65)
LAMBRETТА GT (UK) 200 ('63-'65)

ANT/POST
ANT/POST
ANT/POST
ANT/POST
POST
ANT/POST
POST
POST

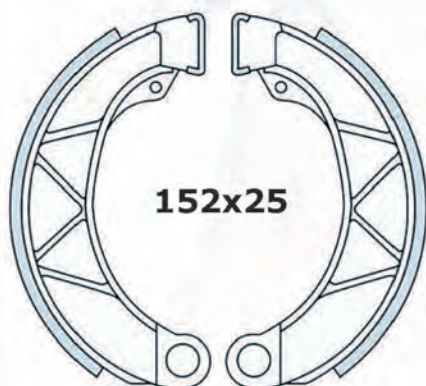

ART. **GF0170**

COPPIA GANASCE

INNOCENTI LAMBRETТА DL 125 ('69-'71) - DL 150 ('69-'71)
LAMBRETТА DL 200 ('69-'71)
LAMBRETТА GP (UK) 125 ('69-'71) - GP (UK) 150 ('69-'71)
LAMBRETТА GP (UK) 200 ('69-'71)

ANT/POST
POST
ANT/POST
POST

SIL LAMBRETТА GP 125 / 150 / 200 (1975-2000)

ANT/POST

Ø 39 x 9

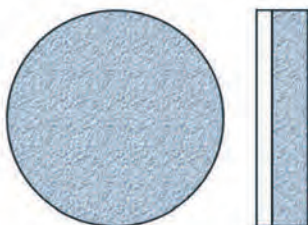

ART. **FD0003**

COPPIA PASTIGLIE

INNOCENTI LAMBRETТА DL 200 ('69-'71)
LAMBRETТА GP (UK) 200 ('69-'71)
LAMBRETТА GT (UK) 200 ('63-'65)
LAMBRETТА SX 200 ('66-'68)
LAMBRETТА TV III 175 ('62-'67) - TV III 200 ('63-'65)

ANT.
ANT.
ANT.
ANT.
ANT.

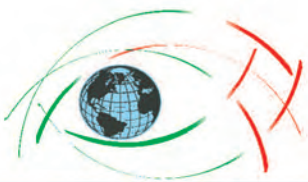

TAMBURO POSTERIORE
LAMBRETTA REAR DRUM

INNOCENTI

Lambretta



ART. **4076**

CONFEZIONE SERIE BLOCCA DADO TAMBURO
DRUM BLock NUT SET
LAMBRETTA LI

ART. **4033**

TAMBURO RUOTA POSTERIORE
CON CONO E RONDELLA
REAR BRAKE DRUM
WITH CONE AND WASHER

LAMBRETTA 125 - 150 - 200 DL E LI

