

CATALOGO RICAMBI MOTO

2014

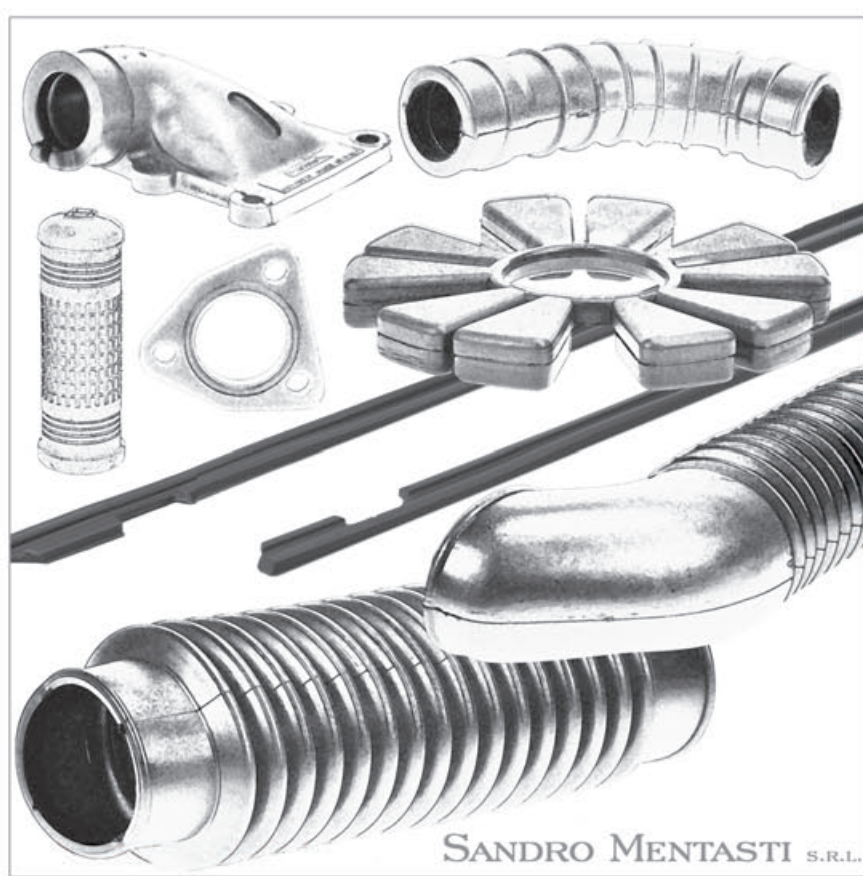

INDICE

| | | | |
|----------------|----|-----------------------|-----|
| AERMACCHI | 3 | MINARELLI | 77 |
| AERMACCHI H.D. | 5 | MI-VAL | 79 |
| ALPINO | 9 | MONDIAL | 79 |
| AMAL | 9 | MORINI | 79 |
| APRILIA | 11 | MOSQUITO | 81 |
| ARCES | 13 | MOTOBI | 83 |
| ARIEL | 13 | MOTOM | 83 |
| BARTALI | 13 | MV | 85 |
| BENELLI | 13 | MZ | 87 |
| BETA | 17 | NSU | 87 |
| BIANCHI | 17 | PARILLA | 87 |
| BINKS | 19 | PUCH | 89 |
| BSA | 19 | RUMI | 89 |
| BSA-TRIUMPH | 19 | SERTUM | 91 |
| BMW | 21 | STERZI | 91 |
| CAGIVA | 23 | SUZUKI | 91 |
| CAPRIOLO | 25 | | |
| CECCATO | 27 | VESPA | 93 |
| DEMM | 27 | PIAGGIO | 111 |
| DKW | 27 | APE | 129 |
| DUCATI | 29 | | |
| FANTIC | 35 | YAMAHA | 133 |
| GABBIANO | 35 | ZÜNDAPP | 135 |
| GARELLI | 35 | | |
| GILERA | 37 | MANOPOLE STANDARD | 137 |
| GITAN | 41 | APPOGGIAPIEDI | 141 |
| GRIMECA | 41 | COPRILEVA | 143 |
| GUZZI | 43 | SOFFIETTI STANDARD | 147 |
| HONDA | 53 | TIRANTI | 153 |
| ISO | 55 | CAPPUCCI CANDELA | 155 |
| KAWASAKI | 57 | GUIDA CATENA | 155 |
| KREIDLER | 57 | SILENT BLOCK | 155 |
| LAMBRETTA | 59 | CAPPUCCI | 156 |
| LAMBRO | 69 | VARI | 157 |
| LAVERDA | 69 | MANICOTTI SCARICO | 161 |
| MAICO | 73 | MANICOTTI CARBURATORE | 163 |
| MALAGUTI | 75 | PARAOLIO MOTORE | 167 |
| MALANCA | 75 | KITS PARAOLIO | 173 |
| MARZOCCHI | 77 | O-RING | 181 |
| MATCHLESS | 77 | TUBO BENZINA | 183 |
| | | | |
| | | | |
| | | | |

| <i>Articolo</i> | <i>Descrizione</i> | <i>Simile al Nr. Orig.</i> |
|-----------------|--|----------------------------|
| 00653/A | Paio Manopole 125 Cc Diam.22/24 | |
| 00653/B | Paio Manopole Diam.24/24 Per Modelli con Cambio al Manubrio - Cigno, Ghibli, Zeffiro | |
| 00664/65/A | Paio Manopole 175-250 Cc. Diam.22-24 | |
| 00830 | Parastrappi Ruota Aermacchi 125 20x10x6,5 | |
| 00930 | Anello Di Guarnizione Per Tubo Flessibile | |
| 01525/A | Paio Copripedale Guidatore In Gomma Dx E Sx | |
| 01527/A | Appoggiapiedi A Scatto Passeggero 175-250 | |
| 01531/A | Coprileva Selettore Cambio 175-250 | |
| 01575/A | Coprileva Cambio 250 Cc. Ala Rossa | |
| 01804 | Parastrappi Ruota Posteriore 125/U 1955 2 Tempi | |
| 04905 | Soffietto a 15 Spire, Diam.48/48 mm. Lungh. 190 - 350 GT/GTS | |
| 04994 | Cappuccio Protezione Interruttore Stop | 14352 |
| 04995 | Cappuccio Interruttore Luce Stop MIs 125/70 | 11293 |
| 04996 | Manicotto Elastico Dado Perno Sterzo | 11904 |
| 04997 | Guarnizione Ritegno Benzina Ala D'Oro | |
| 04998 | Passacavo Guarnizione Bobina | 9000 |
| 05912 | Cappuccio Conico Protez. Carburatore Ala Verde-Blu Gt-250 | |
| 05915 | Giunto Per Carburatore 350 Gt | |
| 05925 | Spessore Appoggio Serbatoio | 6969 |
| 05926 | Cuscinetto Elastico Anteriore Serbatoio | 9412 |
| 05927 | Sostegno Attacco Anteriore Serbatoio | 8008 |
| 05932 | Manicotto Carburatore | 8900 |
| 05936 | Supporto Catarifrangente Forcelle Ant. 350 Ss/71-MIs 125/71 | 10250 |
| 05938 | Tampone Fine Corsa Leva Avviamento 125 Cc. | 9445 |
| 05939 | Tampone Supporto Cabina | |
| 05942 | Tampone Sospensione Anteriore | |



☆ 04905



★ 00653/A
00653/B



★ 00930



★ 00664/65/A



★ 01525/A



★ 01527/A



01575/A



★ 04994



★ 04995



★ 04996



★ 05942



★ 01531/A



★ 05912



★ 05925



★ 05938



★ 05926



★ 05932



★ 05915



★ 04997



★ 04998



★ 05939



★ 05936



★ 05927



★ 01804



★ 00830

| <i>Articolo</i> | <i>Descrizione</i> | <i>Simile al Nr. Orig.</i> |
|-----------------|---|----------------------------|
| 00837 | Parastrappi Ruota Posteriore 175 - 175S - 250 - 250N | |
| 05937 | Cappuccio Estremita' Cavi | 75777 |
| 05945 | Guarnizione Tappo Serbatoio Diam. 37,5x45x2 | 7547 |
| 05946 | Guarnizione Tappo Serbatoio Diam. 40x56x2 | 2964 |
| 05963 | Tampone Elastico Per Supporto Manubrio | 8831 |
| 05963/A | Tampone Elastico Per Supp. Manubrio Sh.80 | 19400 |
| 05964 | Soffietto Per Cornetto Presa Aria 125 Cc. Regolarita` | 16333 |
| 05970 | Cuffia Protezione Cavi Int. Accensione Sx 175/74 E 250 Cc. | 21651 |
| 05974 | Manicotto Aspirazione Diam. 47 Mm.- Sx 250/74 | 20492 |
| 05978 | Manicotto Aspirazione Diam. 39 - Sx 250/74 | 20355 |
| 05981 | Passacavo Condotti Olio - 175 - 1c - 2t | 19618 |
| 05982 | Calotta Forcella Diam. 27 Mm. - Mc 90/73 | 18691 |
| 05985 | Protezione Batteria M 90/73 - Mls 125/73 | 18385 |
| 05986 | Tappo Foro Controllo Messa In Fase Sx 350/73 | 18201 |
| 05987 | Gommino H. 50 Mm. Squad. Fiss. Batteria M 90/73-Mls 125/73 | 18170 |
| 05987/A | Gommino H.30 Mm.Tenuta Laterale Batteria M 90/73-Mls 125/73 | 18169 |
| 05987/B | Gommino H.25 Mm. Appoggio Inferiore Batteria 90 E 125 Cc. | 18168 |
| 05988 | Manicotto Silenziatore Aspirazione Mls 125/73 | 18028 |
| 05989 | Tampone Ancoraggio Anteriore Serbatoio Benzina Mls 125/73 | |
| 05990 | Tappo Sfiato Olio Mc 90 - M 90 - Mls 125 - Msr 100/73 | 17692 |



☆ 05945



☆ 05946



☆ 00837



☆ 05981



☆ 05964



☆ 05974



☆ 05978



☆ 05982



☆ 05970



☆ 05988



☆ 05963
05963/A



☆ 05986



☆ 05987/A



☆ 05987



☆ 05987/B



☆ 05989



☆ 05985



☆ 05990



☆ 05937

| <i>Articolo</i> | <i>Descrizione</i> | <i>Simile al Nr. Orig.</i> |
|-----------------|---|----------------------------|
| 00587 | Copripedale Leva Cambio 125 Cc. | |
| 00664/65 | Paio Manopole 175-250 Cc Diam.22/24 (Marchio Aermacchi Harley Davidson) | |
| 00664/65/H | Paio Manopole 175-250 Cc. - Diam. 22/24 (Marchio Harley Davidson) | |
| 00680/A/H | Paio Manopole Neoprene Diam.22-24 Lungh. 127 Mm. | |
| 00680/H | Paio Manopole Per Wisconsin Diam.22-24 Lungh.117 | |
| 00825 | Parastrappi Ruota Posteriore 125 Cc. | |
| 01518 | Coprileva Avviamento 125 Cc. Foro Diam.13 Lungh.38 | |
| 01525 | Paio Copripedali Guidatore Dx-Sx Per Chimera 175 Cc | |
| 01527/H | Appoggiapiedi A Scatto Per Passeggero 175-250 Cc. | |
| 01531 | Coprileva Cambio 175-250 Cc Diam. 9 Lungh. 42 (Marchio Aermacchi Harley Davidson) | |
| 01531/H | Coprileva Cambio 175-250 Cc. Diam.9 Lungh. 42 (Marchio Harley Davidson) | |
| 01553 | Coprileva Avviamento - Lunghezza 61 Mm. (Marchio Aermacchi Harley Davidson) | 4362 |
| 01553/H | Copripedale Avviamento - Lunghezza 61 Mm. (Marchio Harley Davidson) | 4281 |
| 01553/HL | Copripedale Avviamento - Lunghezza 72 Mm. (Marchio Harley Davidson) | 11484 |
| 01555/H | Copripedale Guidatore Wisconsin 250/H Foro Diam.38 | |
| 01574 | Copripedale Guidatore (Marchio Aermacchi Harley Davidson) | 7058 |
| 01574/H | Copripedale Guidatore (Marchio Harley Davidson) | 7058 |
| 01575 | Coprileva Freno E Cambio Diam.9 Mm. 250 Ala Rossa (Marchio Aermacchi Harley Davidson) | |
| 01575/H | Coprileva Freno E Cambio 250 Cc. (Marchio Harley Davidson) | |
| 01577 | Coprileva Avviamento Diam. 9 Mm. (Marchio Aermacchi Harley Davidson) | 6412 |
| 01577/H | Coprileva Avviamento Diam. 11 Mm. (Marchio Harley Davidson) | 7062 |
| 01817 | Parastrappi Ruota Posteriore 250 - 250 N | |
| 01820 | Parastrappi Mozzi Salvai - Amf | |
| 01844 | Parastrappi 350 Cc. 4t | 11874 |
| 01846 | Parastrappi 125 Sxt -> '81 - 125 Sst -> '83 | 12434 |
| 01848 | Parastrappi Mozzo Grimeca Aletta 125 Regolarita' | 621107792 |
| 01851 | Guarnizione Tappo Serbatoio Benzina Diam.57x42x3 | |
| 03963 | Guarnizione Tappo Serbatoio | |
| 03984 | Cappuccio Presa Corrente Fanale Posteriore 250 Cc. | 4086 |
| 03985 | Tampone Attacco Anteriore Serbatoio Benzina 175-250 Cc. | |
| 03986 | Tampone Attacco Posteriore Serbatoio Benzina 175-250 Cc. | |
| 03993 | Tampone Coperchio Protezione Catena 175-250 Cc. | |
| 05913 | Tampone Ammortizzatore | 4783 |
| 05914 | Tampone Sospensione Posteriore | 28330 |



★ 01555/H



★ 00680/A/H
00680/H



★ 01574
01574/H



★ 00664/65
00664/65/H



★ 01525



★ 01527/H



★ 01575
01575/H



★ 00587



★ 01577
01577/H



★ 01531
01531/H



★ 01518



★ 05913



★ 05914



★ 00825



★ 01553
01553/H
01553/HL



★ 01817



★ 03986



★ 01844



★ 03984



★ 01820



★ 01846



★ 03963



★ 01851



★ 01848



★ 03985



★ 03993

| <i>Articolo</i> | <i>Descrizione</i> | <i>Simile al Nr. Orig.</i> |
|-----------------|--|----------------------------|
| 05924 | Tampone Appoggio Serbatoio | 7912 |
| 05928 | Tampone Appoggio Serbatoio | 9032 |
| 05929 | Tampone Appoggio Serbatoio | 8236 |
| 05940 | Passacavo | 7652 |
| 05983 | Tampone Serbatoio | 18555 |
| 06960/A | Racc. Carburatore Diam. 35 - 350 Cc 2c 2t Corsa Per Mikuni | 28852 |
| 06960/B | Manicotto Carburatore Diam.38-250/350 Corsa Mikuni | |
| 06960/C | Manicotto Carburatore Diam.36 - 250/350 Corsa - | |

ALPINO

| <i>Articolo</i> | <i>Descrizione</i> | <i>Simile al Nr. Orig.</i> |
|-----------------|---|----------------------------|
| 00572 | Copripedale Guidatore Diam. 13 | |
| 00580 | Coprileva Selettore Cambio | |
| 00637 | Paio Manopole Diam. 22-24 (Marchio Alpino) | |
| 00637/A | Paio Manopole Diam. 24-24 Per Modello con Micromotore | |
| 02813 | Cuscinetto Per Ammortizzatore | 90307 |
| 02814 | Rondella Per Tubo Porta-Fanale Diam.36x25 | 90463 |
| 02814/A | Rondella Per Tubo Porta-Fanale Diam.36x30 | |
| 05862 | Distanziale Per Tirante 175 Cc. 4 Tempi | |
| 05863 | Copertura Di Tenuta Per Dado Presa Diretta | |

AMAL

| <i>Articolo</i> | <i>Descrizione</i> | <i>Simile al Nr. Orig.</i> |
|-----------------|---|----------------------------|
| 09991 | Manicotto Carb.Amal Serie 2900 Foro Passaggio 34 Mm | |
| 09998 | Manicotto Carburatore Amal Diam.28 Mm. | |
| 09999 | Manicotto Carburatore Amal Diam. 40 Mm. | |



05924



05929



05928



05940



05983



★ 06960/A



★ 06960/B



★ 06960/C

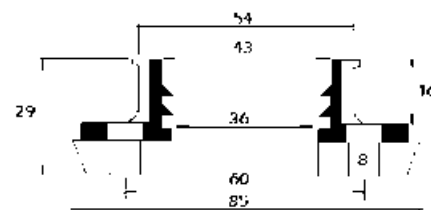
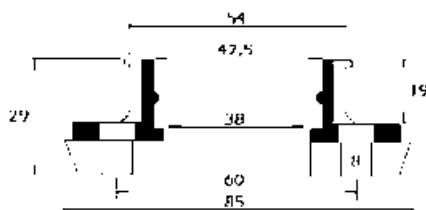
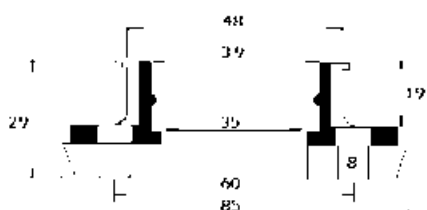

ALPINO



★ 00572



★ 00580



★ 02813



★ 05862



★ 00637
00637/A



★ 02814



★ 02814/A



★ 05863

AMAL



09991



09998



09999

| <i>Articolo</i> | <i>Descrizione</i> | <i>Simile al Nr. Orig.</i> |
|-----------------|---|----------------------------|
| 00914/D | Manicotto Marmitta | 8200003 |
| 00922 | Cappuccio A Pipa | 8120218 |
| 01582 | Coprileva Cambio | 8420007 |
| 01584 | Coprileva Cambio | 8220189 |
| 02519 | Coprileva Cambio | 8220276 |
| 03935 | Cappuccio | 8120482 |
| 04958/A | Soffietтино Cavi | 8120409 |
| 05916 | Manicotto Marmitta | 8120375 |
| 05924 | Tampone Appoggio Serbatoio | 8420003 |
| 05928 | Tampone | 8120001 |
| 05931/A | Cappuccio | 8220135 |
| 05940 | Passacavo | 8120405 |
| 05989/A | Tampone Ancoraggio Serbatoio | 8120221 |
| 05996 | Rondella | 8120276 |
| 06919 | Gommino Cavalletto | 8120455 |
| 06945/A | Pattino Tendicatena | 8101736 |
| 06958/A | Anello Elastico | 8120272 |
| 06963/A | Silentblock | 8120402 |
| 06975 | Manicotto Marmitta | 8101319 |
| 07904 | Gommino Cavalletto | 8120220 |
| 07946 | Gommino Cavalletto | 8120857 |
| 08986/A | Silentblock | 8201121 |
| 08998 | Supporto Ammortizzatore | 8120249 |
| 09949 | Passacavo | 8120030 |
| 09992 | Manicotto Marmitta | 8220297 |
| 10937 | Manicotto Carburatore Aprilia-Peugeot Scooter | 8206118 |
| 10949 | Tampone Ritorno Cavalletto Amico 50 - Sr - Scarabeo | 8220239 |
| 12934 | Manicotto Aspirazione Leonardo 125-150 96-2004 | 8120888 |



06958/A



02519



01852



01584



05916



06975



00914/D



09992



05931/A



★ 07946



05924



10949



03935



09949



05940



05996



05989/A



08998



07904



05928



06919



08986/A



06963/A



06945/A



00922



04958/A



10937



12934

| <i>Articolo</i> | <i>Descrizione</i> | <i>Simile al Nr. Orig.</i> |
|-----------------|---|----------------------------|
| 04975 | Calotta Forcella Diam.30 Arces-Ceriani | |
| 04975/A | Calotta Forcella Diam.32 Arces-Ceriani | |
| 04990 | Calotta Forcella Diam.30 Tipo Arces-Ceriani | |
| 04991 | Calotta Forcella Diam.35 Tipo Arces-Ceriani | |
| 06903 | Calotta Forcella Diam.35 Tipo Arces-Ceriani | |
| 06903/A | Calotta Forcella Diam.35 Con Asola Tipo Arces-Ceriani | |
| 06904 | Calotta Forcella Diam.38 Tipo Arces-Ceriani | |

ARIEL

| <i>Articolo</i> | <i>Descrizione</i> | <i>Simile al Nr. Orig.</i> |
|-----------------|--|----------------------------|
| 00527 | Coprileva Passeggero Foro Rettangolare | |

BARTALI

| <i>Articolo</i> | <i>Descrizione</i> | <i>Simile al Nr. Orig.</i> |
|-----------------|-------------------------------------|----------------------------|
| 00506/B | Copripedale Guidatore Foro Cieco 14 | |

BENELLI

| <i>Articolo</i> | <i>Descrizione</i> | <i>Simile al Nr. Orig.</i> |
|-----------------|-------------------------------|----------------------------|
| 00407/08 | Paio Ginocchiere Dx E Sx | |
| 00541 | Copripedale Guidatore 250 Cc. | |
| 00595 | Coprileva Cambio 125-150 Cc. | |



★ 04975



★ 04975/A



★ 04990



★ 04991



★ 06903



★ 06903/A



★ 06904



★ 00527



★ 00506/B



★ 00407/08



★ 00541



★ 00595

| <i>Articolo</i> | <i>Descrizione</i> | <i>Simile al Nr. Orig.</i> |
|-----------------|--|----------------------------|
| 00520 | Copripedale Guidatore | |
| 00685 | Paio Manopole Neoprene Diam. 22/24 - 125-250 Ss | |
| 00909 | Giunto Elastico Per Magnete Foro Diam.25 | |
| 00910 | Giunto Elastico Per Magnete Foro Diam.35 | |
| 01591 | Copripedale Guidatore Lungh.94 Foro Cieco A Sezione Ovale | |
| 02508 | Tappeto Per Telaio Bobo 50 Cc. | N253 |
| 02512 | Tappeto Chiu' | 4040060799 |
| 03933 | Boccola Per Ammortizzatore Posteriore Diam. 24x14x16 | |
| 05859 | Anello Di Tenuta Olio Albero Messa In Moto 125cc.(18,5x15x7) | |
| 06917 | Copridado Diametro 19 Anteriore 125 - 250 Cc. | 20Z3297 |
| 06918 | Copridado Posteriore 125 - 250 Cc. Diam. 21 Mm | 20Z3298 |
| 06918/A | Copri Dado Esagono 23 Mm | 2880730799 |
| 06964 | Passacavo Ovale Per Borsette 125-250 2c | 39461600 |
| 07909 | Tampone Sospensione Posteriore Serbatoio 50 Cross | 93180581 |
| 07914 | Passacavo Borsette Laterali E Sella 2 T 50 Cc. 5v Turismo | 91551104 |
| 07916 | Passacavo Antivibrante Vari Usi 650 Cc 4 T | 91551082 |
| 07928 | Supporto Fanalino | 17ES3038 |
| 07929 | Sostegno Antivibrante Intermittenza 650 4 T Es | 17751200 |



★ 02508



★ 02512



★ 00685



★ 06918

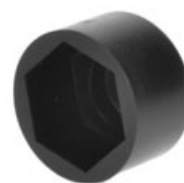

★ 06918/A



★ 00520



★ 01591



★ 07909



★ 07914



★ 07916



★ 05859



★ 03933



★ 06964



★ 06917



★ 00909



★ 00910



★ 07928



★ 07929

| <i>Articolo</i> | <i>Descrizione</i> | <i>Simile al Nr. Orig.</i> |
|-----------------|--|----------------------------|
| 00539/B | Coprileva Cambio Diam. 11 Mm. | |
| 01520 | Copripedale Guidatore Foro Diam. 10 Mm | |

BIANCHI

| <i>Articolo</i> | <i>Descrizione</i> | <i>Simile al Nr. Orig.</i> |
|-----------------|---|----------------------------|
| 00509 | Copripedale Guidatore Foro Cieco 14 - 125Cc. - 175 Cc. | 73482 |
| 00519 | Paio Copripedali Guidatore 250-500 Cc. | 3077 |
| 00588 | Copripedale Passeggero Foro Quadro 175 Cc. Cervino / Pordoi - 125 Cc. Mendola | 75958 |
| 00612/12/A | Paio Manopole 500 Cc Diam 24/27 - Grigio | |
| 00612/A-N | Paio Manopole 500 Cc Diam 24/27 - Nere | 22139 |
| 00614/14/A | Paio Manopole Foro Passante 125 Cc Diam.22/24 | 73867 / 73868 |
| 01508 | Coprileva Avviamento Diam. 11 - 175 Cc. Cervino / Pordoi | 85148 |
| 01538 | Copripedale Guidatore Foro 14 - Mendola | H 13482 |
| 01996 | Sostegno Motore Aquilotto | |



★ 01520



★ 00539/B

BIANCHI



★ 00519



★ 00509



★ 00588



★ 00612/A-N



★ 01538

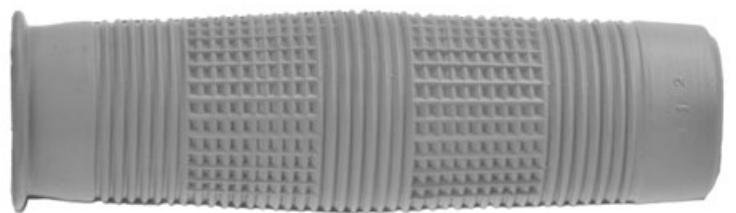

★ 00612/12/A

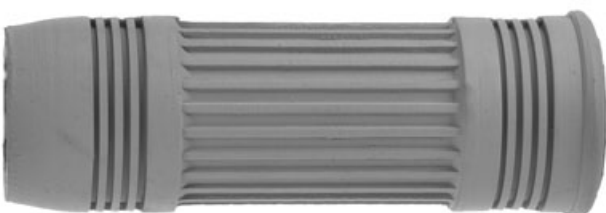

★ 00614/14/A



★ 01508



★ 01996

| <i>Articolo</i> | <i>Descrizione</i> | <i>Simile al Nr. Orig.</i> |
|-----------------|--|----------------------------|
| 00606 | Paio Manopole | |
| 00606/7 | Paio Manopole Binks Pvc Foro Cieco Diam. 22/24 | |
| 00606/7A | Paio Manopole Binks In Pvc Con Anello Paramano Diam. 22/24 | |
| 00606/7-GR | Paio Manopole Binks Foro Cieco Diam. 22/24 - Grigio | |
| 00608/A | Manopola Tipo Binks Diam. 24 | |
| 00609 | Manopola Tipo Binks Diam. 27 | |

BSA

| <i>Articolo</i> | <i>Descrizione</i> | <i>Simile al Nr. Orig.</i> |
|-----------------|--|----------------------------|
| 02527 | Copripedale Passeggero Foro Cieco Quadro 20 X 20 Lungh.110 | |
| 02528 | Copripedale Guidatore Foro Cieco Rett. 18 X 11 Lungh.118 | |
| 04982 | Soffietto Forcella Bsa/Bantam Diam.22/26 5 Spire Lungh.160 - D1-D3-D5 dal 48 al 58 | |

BSA - TRIUMPH

| <i>Articolo</i> | <i>Descrizione</i> | <i>Simile al Nr. Orig.</i> |
|-----------------|---|----------------------------|
| 00403/04 | Paio Ginocchiere Dx E Sx Marchio Triumph | |
| 00523 | Copripedale Guidatore | |
| 05954 | Soffietto Forcella Diam.50/55 Lungh.215 Bsa-Triumph | |
| 05955 | Soffietto Forcella Diam.30/40 Lungh.150 Triumph | |
| 05956 | Soffietto Forcella Diam.50/50 Lungh.150 Triumph | |



★ 00606

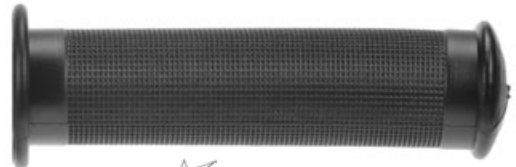

★ 00606/7



★ 00608/A

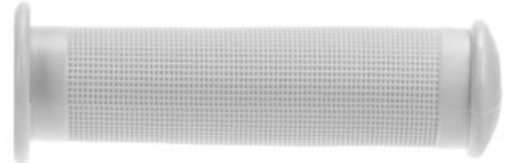

★ 00606/7-GR



★ 00606/7A

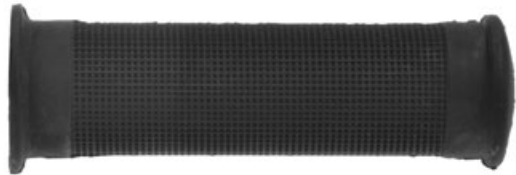

★ 00609

BSA



★ 02527



★ 02528



★ 04982

BSA - TRIUMPH



★ 05954



★ 05955



★ 05956



★ 00403/04



★ 00523

| <i>Articolo</i> | <i>Descrizione</i> | <i>Simile al Nr. Orig.</i> |
|-----------------------|--|--------------------------------|
| 01594 | Copripedale Guidatore | 46711234660 |
| 01595 | Coprileva Cambio | |
| 01616 | Paio Manopole in Spugna | |
| 01690/F | Paio Manopole 22/24 (Forate) | 32721458395 DX - 3272145839 SX |
| 01690/F/24 | Paio Manopole 26-26 Per Comandi Riscaldati | |
| 02541 | Pedana K 75/100 1983-84-85 | 467 11451 982 |
| 02624/C | Paio Manopole 26-26 Per Comandi Riscaldati Fondello Chiuso | |
| 02624/L | Paio Manopole 26-26 Per Comandi Riscaldati Dal 2009 Lunghezza 125 Mm | |
| 06905 | Soffietto Forcella - R75/5 | 31421234908 |
| 06906 | Paraolio Tubo Asta-Valvole | 11110033163 |
| 06991 | Soffietto Forcella - R 51 | UA309625 |
| 08904 | Soffietto Forcella F 650 | |
| 09974 | Paio Soffietti Forcella K100 | |
| 10998 | Paraolio Pinza Freno 40 Mm Ate | 34111233317 |
| 10999 | Guarnizione H=3 Interno Pinza Freni Ate 40 Mm | |
| 10999/A | Guarnizione H= 3 Mm Interno Pinza Freni Ate 38 | |
| 11902 | Silentblock Porta Batteria Bmw | 61211233028 |
| 11904 | Cappuccio Spurgo Pompa Freno Brembo - Confezione Da 20 Pezzi | |
| 11919 | Silentblock Piastra Diodi Bmw | 12311358131 |
| 11935 | Profilo per Contatto Cavità Freno Serie R (confez. 25 Metri) | 11141262644 |
| 12918 | Paraolio Pistone Frizione Bmw Tutti I Modelli Dal 1955-1980 | 2152020109 |
| Articoli Non Figurati | | |
| ARI.003T | Kit Paraolio Forcella Dcy 35 X 48 X 11 | |
| ARI.023 | Kit Paraolio Forcella Tcy 40 X 52/52,7 X 10/10,5 | 31421458064 |
| ARI.028 | Kit Paraolio Forcella Tcl 41,7 X 55 X 7,5/1 | |
| ARI.042 | Kit Paraolio Forcella Rii Serie Monoshock Fino Al 1985 | 31422310199 |
| ARI.043 | Kit Paraolio Forcella R I Serie Dal 1970 Al 1984 | 31421230001 |
| ARI.045 | Kit Paraolio Forcella K 16v. Dal 1990 | 31421450127 |
| ARI.047 | Kit Paraolio Forcella F 650 Dal 1994 - R100r | 31422312838 |
| ARI.083 | Kit Paraolio Forcella Dc4y 41,7 X 55 X 7,5/10 | 31422312928 |
| ARI.084 | Kit Paraolio Forcella R 2 Cilindri 2 Valvole Dal 1985 | 31422310199 |
| P/092 | Paraolio Sc 32 X 20 X 7 | 11111262977 |
| P/194 | Paraolio Sc 47 X 28 X 7 | 11141255011 |
| P/268 | Paraolio Sc 100 X 80 X 10 | 11111261739 |
| P/338 | Paraolio Scr 40 X 26,5 X 9 Albero Cambio R2 5 Marce Dal 1984 | 23121338726 |
| P/347 | Paraolio Hscr 32 X 20 X 7 In Silicone (Motore) | |
| P/348 | Paraolio Hscr 47 X 28 X 7 (Motore) | |
| P/349 | Paraolio Hscr 25 X 12 X 8 In Silicone (Motore) | |
| P/350 | Paraolio Hscl 100 X 78 X 10 In Silicone (Motore) | |
| P/356 | Paraolio Sc 70 X 40 X 7,5 | 23121232681 |
| P/357 | Paraolio Sc 85 X 65 X 10,5 | 33123004343 |
| P/358 | Paraolio Tc 25 X 12 X 7 | 11141261193 |
| P/359 | Paraolio Tc 28 X 17 X 7/6 | |



01690/F
01690/F/24



02624/L
02624/C

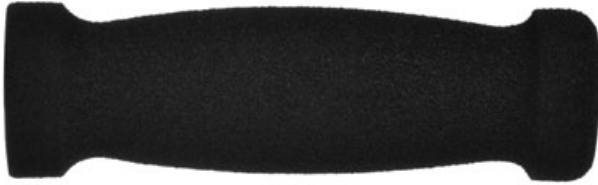

01616



02541



11935



★ 01594



★ 01595



★ 06906



11904



10998



10999/A



10999



12918



11902



11919



★ 06905



★ 06991

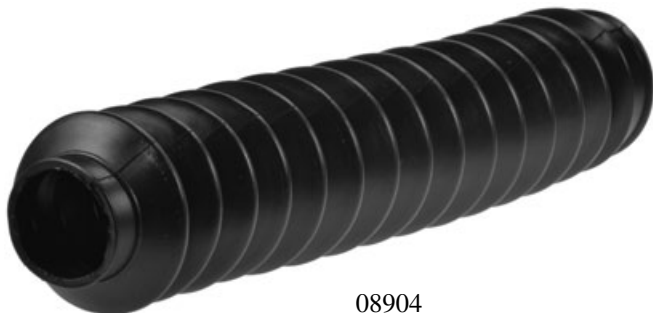

08904



09974

| <i>Articolo</i> | <i>Descrizione</i> | <i>Simile al Nr. Orig.</i> |
|-----------------|---|----------------------------|
| 00921 | Cappuccio A Pipa | 800040923 |
| 00922 | Cappuccio A Pipa | 800063496 |
| 00923 | Cappuccio A Pipa | 800040922 |
| 00927 | Passacavo | 60N023028 |
| 00950 | Passacavo Commutatore | 800023029 |
| 00972 | Tappo Protezione Nero | 80A058394 |
| 00972/A | Tappo | 800072202 |
| 01661/SSF | Paio Manopole | |
| 01909 | Tampone Parafango | 800023962 |
| 02533 | Copripedale Freccia C9-12-Paso 750 | 37069940 |
| 02943 | Passacavo | 800034888 |
| 04901 | Tappo Depuratore | 800039030 |
| 04947 | Passacavo | 800041862 |
| 04975 | Calotta Forcella Arces-Ceriani Stelo Diam. 30 | |
| 04999 | Cappuccio Candela In Silicone | 800023158 |
| 04999/L | Cappuccio Candela In Silicone | 800051139 |
| 05914 | Tampone Sospensione | 800028330 |
| 05916/C | Manicotto Marmitta | 800037884 |
| 05918 | Gommino Appoggio Inferiore Targa | 800066308 |
| 05924 | Manicotto | 800007912 |
| 05962 | Anello Passacavo | 800033056 |
| 05996/A | Rondella 16 X 5 X 1,5 | 800037656 |
| 06910 | Passacavo Radiatore | |
| 06958 | Anello Elastico | 800029868 |
| 06958/A | Anello Elastico | |
| 06975 | Manicotto Marmitta | 800031632 |
| 06996/B | Rullo Guidacatena | 800033470 |
| 07938 | Pipetta | 800025989 |
| 07998 | Tirante Con Asola | 800031981 |
| 08978 | Cappuccio | 800052347 |
| 09949 | Passacavo | 800018048 |
| 10928 | Cappuccio Passacavo | 800021615 |



00921



00922



00923



07938



04999



04999/L



05916/C



06975



10928



09949



04947



00927



★ 00950



05924



04901



★ 06910



02943



★ 05914



05996/A



★ 01909



06996/B



★ 00972/A



05918



★ 00972



08978



05962



07998



06958/A
06958



★ 04975



02533



01661/SSF

| <i>Articolo</i> | <i>Descrizione</i> | <i>Simile al Nr. Orig.</i> |
|-----------------|---|----------------------------|
| 00850 | Parastrappi Capriolo 125 Cc - Diam. 23 X 11 Foro 6,5 Decentrato | |
| 00999 | Soffietto Forcella Capriolo 75 Cc Dal 1951 Diam. 29/30 Lungh. 170 | |
| 01506 | Copripedale Guidatore Foro Diam 14 Capriolo 125 Gt Dal 1958 | |
| 01506/A | Copripedale Guidatore Foro Diam. 12 Capriolo 75 Dal 1951 | |
| 01506/B | Copripedale Guidatore 75 Aeromere Foro Rettangolare 24 X 5 Dal 1958 | |
| 01545/A | Paio Copripedali Guidatore Dx + Sx - 100 Cc Bondone | |
| 01998 | Boccola Per Arresto Messa In Moto | |
| 03905 | Boccola Guida Canotto Forcella 125 Cc | |
| 03930 | Blocchetto Per Gruppo Portatarga 125 Cc | |
| 03940 | Passacavo Isolante Cavo Lato Volano | |
| 03941 | Passacavo Volano | |



☆ 00850



☆ 03940



☆ 03941



☆ 03905



☆ 01998



☆ 01506/A



☆ 01506/B



☆ 01545/A



☆ 01506



☆ 00999



☆ 03930

| <i>Articolo</i> | <i>Descrizione</i> | <i>Simile al Nr. Orig.</i> |
|-----------------|---|----------------------------|
| 00606/7 | Paio Manopole Diam. 22-24 | |
| 00662 | Paio Manopole 22-24 Marchio Ceccato | |
| 01505 | Copripedale Guidatore Foro Diam.14 | |
| 01517 | Copripedale Guidatore Foro Diam. 12 - 14 - 16 (Specificare Diam.) | |
| 01528 | Coprileva Avviamento Foro Passante Diam.11 Lungh.62 | |
| 01529 | Coprileva Cambio Foro Diam.9 Lungh.51 | |
| 01530 | Coprileva Cambio Foro Diam.11 Lungh.30 | |
| 02891 | Guarnizione Paraolio Motore Lato Volano | |
| 04851 | Paraolio Forcella Marzocchi Diam. 30 | |
| 04852 | Paraolio Forcella Marzocchi Diam.35 | |

DEMM

| <i>Articolo</i> | <i>Descrizione</i> | <i>Simile al Nr. Orig.</i> |
|-----------------|-------------------------------|----------------------------|
| 00594 | Copripedale Guidatore Foro 14 | |
| 01819 | Parastrappi | |
| 02968 | Boccola Attacco Motore | |
| 03947 | Tampone Frizione Velomatic | |
| 04944 | Tampone Frizione Velomatic | |

DKW

| <i>Articolo</i> | <i>Descrizione</i> | <i>Simile al Nr. Orig.</i> |
|-----------------|--|----------------------------|
| 00413/14 | Paio Ginocchiere Dkw Modelli NZ dal 1938, Modelli RT dal 1949 | 172207 |
| 00549 | Pedana Guidatore Modelli SB dal 1933 - Diam. 15 mm. | |
| 00571 | Pedana Guidatore Modelli NZ dal 1938 - Diam. 18 mm. | |
| 00697 | Paio Manopole Magura Per Ciclomotori - Dkw Mofas Tutti I Modelli | |
| 08934 | Soffietto Forcella Dkw 200-250 Cc Fino Al 1955 | |
| 08935 | Soffietto Forcella Dkw 250-350 Cc Dal 1955 | |
| 08936 | Soffietto Forcella Dkw Hummel Ts De Luxe Dal 1963 | |



☆ 00571



☆ 00549



★ 01505



★ 01517



★ 00606/7



★ 00662



★ 01528



★ 01529



★ 01530



★ 02891



★ 04851



★ 04852

DEMM



★ 00594



★ 02968



★ 03947



★ 04944



★ 01819

DKW



★ 00413/14



★ 00697



★ 08935



★ 08936



★ 08934

| <i>Articolo</i> | <i>Descrizione</i> | <i>Simile al Nr. Orig.</i> |
|-----------------|---|----------------------------|
| 00501 | Copripedale Guidatore 60 Cc. | |
| 00506/A | Copripedale Guidatore 98 Cc. - Foro Diam. 18 Mm. Dal 1952 Al 1962 | |
| 00510 | Coprileva Cambio | |
| 00557 | Coprileva Avviamento | M300121 |
| 00569 | Coprileva Cambio 60 Cc. | |
| 00570 | Coprileva Cambio-Freno 60 Cc. | |
| 00591 | Copripedale Guidatore In Gomma 65t-TI - Foro Rettangolare | |
| 00626/26/A | Paio Manopole Diam.21/23 | |
| 00840 | Parastrappi Ruota Posteriore 98 Cc. Sport | |
| 00861 | Paraolio Forcella Marzocchi Ducati Sport 85-125 | |
| 00918 | Soffietto Sospensione Posteriore 48 Cc. | |
| 01510 | Coprileva Cambio 98 Cc. Foro Rettangolare Lungh.56 | |
| 01535 | Coprileva Cambio | 9007320 |
| 01539 | Coprip.Guid. 100 Sport - 125 Sport Dal 1957 -125ts 1961/1965 160 Monza Junior 1966 - 175 Dal 1958 - 200 Elite 1959/1965 250 Mach 1 1963/1966 - Mark 3250/350/450 Dal 1965 | 044069 |
| 01572 | Coprileva Guidatore | 68969110 |
| 01582 | Coprileva | 32513553 |
| 01589 | Coprileva | 75507350 |
| 01843 | Parastrappi A Stella Mozzi Grimeca Diam.179 Spessore 20 Mm. | 079580230 |



| <i>Articolo</i> | <i>Descrizione</i> | <i>Simile al Nr. Orig.</i> |
|-----------------|--|----------------------------|
| 00921 | Cappuccio | 46038030 |
| 00927 | Passacavo | 002381055/3 |
| 01809 | Parastrappi Campagnolo Ducati | |
| 03901/A | Boccola 18,5 X 14,5 X 16,5 | 70010081A |
| 03912/A | Soffietto Raccordo Carburatore/Filtro | 069291110 |
| 03988 | Cinghia Batteria | 69891903 |
| 04914/A | Soffietto Aspirazione 750 - 750 Gt - 19 Spire | |
| 04914/B | Soffietto Aspirazione Tagliato A 15 Spire - Imb. 39 Mm | |
| 04947 | Passacavo | 79772068 |
| 05855 | O.Ring Passaggio Olio Fra Cilindro E Testa 100-125-175 Cc. | |
| 05924 | Silentblock | 37084180 |
| 05930 | Flangia Dia. 25,5 | |
| 05930/A | Flangia Diam. 28,5 | 060192270/1 |
| 05930/D | Flangia Diam. 32 | |
| 05962 | Passacavo Ad Anello | 79791070 |
| 05983 | Tampone | 79783030 |
| 05996 | Rondella | 079585060/1 |
| 06875/S | Guarnizione Stelo Valvole - Silicone Neutro | |
| 06875/V | Gommino Viton Per Valvola | 76410091A |
| 08928 | Tirante Serbatoio Pantah | 0066083175 |
| 09949 | Passacavo | 36198690 |
| 10909 | Passacavo | 36191730 |
| 10957 | Gommino Valvole Ducati In Viton Nero | 76410131A |
| 10958 | Gommino Valvole In Viton Nero | 76410092A |
| 12919 | Rondella Passacavo | 068983040/1 |
| 12920 | Tappo | 0609922235 |



10909



★ 03901/A



10958



06875/V
06875/S



10957



04947



09949



★ 12919



00927



★ 12920



★ 05855



05996



05924



05962



00921



05983



★ 05930/A
05930/D



★ 05930



★ 01809



08928



03988



★ 04914/B



03912/A



★ 04914/A

| <i>Articolo</i> | <i>Descrizione</i> | <i>Simile al Nr. Orig.</i> |
|-----------------|---|----------------------------|
| 04983 | Soffietto Forcella | 68937310 |
| 06934 | Supporto Antivibrante Strumenti Scrambler | 069037050 |
| 06934/A | Supporto Contagiri/Km - Interasse Fori Attacco 170 Mm | 069637050 |
| 06953 | Manicotto Carburatore Diam.30 | 062092593 |
| 06953/A | Manicotto Carburatore Diam.20 | 032517758 |
| 06953/B | Manicotto Carburatore Diam.32 | 032517753 |
| 06958 | Anello Elastico | 59567 |
| 09973 | Cuffia Contagiri/Km Ducati | 079637045/2 |
| 10914 | Vaschetta Batteria | |
| 10914/A | Vaschetta Batteria | 069838830/1 |
| 12921 | Guarnizione 72 X 62 X 4,7 | 075949865 |
| 12922 | Gommino Filtro Olio | 075549275 |
| 12923 | Boccola 18,5 X 14,5 X 16,5 | 079637770/1 |
| 12924 | Cappuccio | 060946060 |



★ 12921



06958



★ 12922



★ 12923



★ 12924



★ 10914/A



★ 10914



★ 06953
06953/A
06953/B



★ 06934/A



★ 06934



04983



★ 09973

| <i>Articolo</i> | <i>Descrizione</i> | <i>Simile al Nr. Orig.</i> |
|-----------------|--|----------------------------|
| 03935 | Cappuccio | 12310005790 |
| 04909 | Soffietтини Cavi | 13104000130 |
| 05931 | Cappuccio Cavo Carburatore | 07004006180 |
| 06945/A | Pattino Guidacatena | 5106314123 |
| 06974 | Manicotto Marmitta | 28313005370 |
| 06996/A | Rullo Tendicatena | 46001005690 |
| 08910 | Manicotto Carburatore Mikuni Da 26 - Fantic 50 | 16013005830 |
| 08911 | Manicotto Carburatore 125 Trial | 25048005100 |

GABBIANO

| <i>Articolo</i> | <i>Descrizione</i> | <i>Simile al Nr. Orig.</i> |
|-----------------|---|----------------------------|
| 00592 | Copripedale Guidatore Foro Cieco Diam. 14 - Lungh. 110 Marchio Gabbiano | |

GARELLI

| <i>Articolo</i> | <i>Descrizione</i> | <i>Simile al Nr. Orig.</i> |
|-----------------|--|----------------------------|
| 02807 | Parastrappi Frizione Katia | 003577153 |
| 02807/A | Parastrappi Frizione Katia - Tipo Grande - | |
| 02807/B | Parastrappi Frizione Noi - Vip - 1 Velocita' | 0023917153 |
| 02807/C | Parastrappi Frizione Kickstart 2 V. | 2050107153 |
| 02885 | Guarnizione Con Molla Per Volano 3b 2^ Serie | |
| 04979 | (E) Guarnizione Cilindrica Frizione Automatica | |
| 06994 | Bussola Antivibrante | 0009121543 |
| 06995 | Tampone Spingidisco | 0243577829 |



03935



05931



04909



06974



08910
08911



06945/A



★ 06996/A

GABBIANO



★ 00592

GARELLI



★ 02885



★ 06994



★ 06995



★ 04979



★ 02807



★ 02807/A

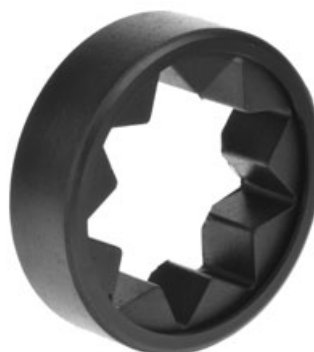

★ 02807/B



★ 02807/C

| <i>Articolo</i> | <i>Descrizione</i> | <i>Simile al Nr. Orig.</i> |
|-----------------|--|----------------------------|
| 00506 | Copripedale Guidatore 500 Cc. Foro Cieco 14 | |
| 00516 | Coprileva Cambio VI - Foro Passante Diam.9 - Mod- 1936 | |
| 00610/11 | Paio Manopole Gilera | |
| 00610/11A | Paio Manopole Con Paramano (Marchio Sul Fondello) - B300 - 175 E | 22370 - 22371 |
| 00610/11AR | Paio Manopole - Rosso | |
| 00610/11GR | Paio Manopole Gilera G. 150 | 6271 |
| 00814 | Parastrappi 125-150 Cc. 3 Marce Turismo Mm. 18 X 10 X 9 | |
| 00819 | Parastrappi 150 Cc. 4 Marce Turismo E Sport Mm. 26x14x12 | |
| 00822 | Parastrappi Ruota Posteriore 250 Cc. | |
| 00843 | Parastrappi Ruota Posteriore 300 Cc. Diam. 30x13x16 Mm. | |
| 00848 | Parastrappi Ruota Poster.175 Cc.Turismo Ø 25x15x13 | |
| 00849 | Parastrappi Ruota Posteriore 175 Sport | 27588 |
| 00907 | Anello Parapolvere Mozzo Ruota 250 Cc. | |
| 01534 | Coprileva Freno 125-175 Cc. | |
| 01546 | Coprileva Cambio (Posteriore) Giubileo - Ovale - Foro Rettangolare Verticale 14x4 - Lungh.40 Giubileo tutte le Versioni 98/124/150/175 Cc. dal 1959 al 1968 | 22929 |
| 01546/A | Coprileva Cambio (Anteriore) Giubileo - Ovale - Foro Rettangolare Verticale 14x4 - Lungh.60 Giubileo tutte le Versioni 98/124/150/175 Cc. dal 1959 al 1968 | 22264 |
| 01547 | Coprileva Avviamento Diam.14 Lungh.78 - Foro Cieco | |
| 01830 | Parastrappi Mozzi Grimeca Diam.116 4 Fori - Giubileo 98 - Extra 29921 | 21696 |
| 01851/A | Guarnizione Tappo Serbatoio Benzina Diam.61x40x4 | |
| 01869 | Guarnizione Forcella 150 Cc. Diam.30,5x24x4 | |
| 02878 | Guarnizione Astina Frizione 150 Cc. | |



★ 00506



★ 00516



★ 01546/A



★ 01546



★ 01547



★ 0610/11
00610/11GR



★ 00610/11A
00610/11AR



★ 00814



★ 00819



★ 00822



★ 00843



★ 00848

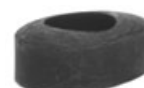

★ 00849



★ 01851/A



★ 01869



★ 00907



★ 02878



★ 01830



★ 01534

| <i>Articolo</i> | <i>Descrizione</i> | <i>Simile al Nr. Orig.</i> |
|-----------------|--|----------------------------|
| 00405/06 | Paio Ginocchiere 250-500 Cc. - 1947 | 9239/9240 |
| 00417/18 | Paio Ginocchiere Dx-Sx Per 98 Ss - 124 5v Special | 664089/64090 |
| 00504 | Copripedale Guidatore Saturno-Nettuno Foro Pass.14 Mm. | 6332 |
| 00505 | Copripedale Guidatore Mod. VI Foro Passante 14 | |
| 00507 | Coprileva Cambio Saturno 500 Parallelogrammo '46/52 - Nettuno 250 Turismo '47/52 | |
| 00538 | Copripedale Guidatore 125-150-300 Cc. dal 1951 al 1964 - Foro Cieco Diam. 14 - Lungh.105 | 21367 |
| 00539 | Coprileva Cambio 125-150 Turismo - Foro Cieco Diam.10 - Lungh.53 | |
| 00539/A | Coprileva Cambio 150 - 300 Sport Foro Rettangolare | 22264 |
| 02946 | Boccola Attacco Posteriore Serbatoio 175 Cc. | |
| 02947 | Boccola Attacco Serbatoio | 26233 |
| 02948 | Boccola Trascinamento Ventola Motocarro 150 Cc. | |
| 03921 | Boccola Attacco Anteriore Serbatoio Benzina 150 Cc. 2 Serie | |
| 03988 | Cinghia Fissaggio Batteria - Giubileo 98 - 124 Cc. | 26550 |
| 04916 | Tappo Ispezione Catena B/300 Cc. | |
| 04925 | Soff.Parapol.Paraf.Anteriore | |
| 04954 | Soffietto Aspirazione Carburatore Scooter | 45349 |
| 04955 | Manicotto Carburatore 175 Cc. | |
| 05854 | Guarnizione Ad Anello Per Tamburo Frizione 125 - 150 Cc. | |
| 05919 | Passafilo Astina Frizione 98-124-175 Cc. | 29613 |
| 06911 | Soffietto Aspirazione 50 Cc. | |



03988



★ 00405/06



★ 00417/18



★ 00504



★ 00505



★ 00538



★ 00539



★ 00539/A



★ 00507



★ 04954



★ 02947



★ 02948



★ 05854



★ 03921



★ 02946



★ 04916



★ 05919



★ 06911



★ 04955



★ 04925

| <i>Articolo</i> | <i>Descrizione</i> | <i>Simile al Nr. Orig.</i> |
|-----------------|---|----------------------------|
| 00574 | Copripedale Guidatore Lungh. Mm.110 Foro Cieco Diam. 14 Mm. | |
| 00635/36 | Paio Manopole Diam.22-24 | |

GRIMECA

| <i>Articolo</i> | <i>Descrizione</i> | <i>Simile al Nr. Orig.</i> |
|-----------------|---|----------------------------|
| 01803 | Parastrappi Mozzi Grimeca Diam.145 | 1730 |
| 01807 | Parastrappi Mozzi Grimeca | 621102452 |
| 01823 | Parastrappi A Stella Mozzi Grimeca Diam.83 | 621306582 |
| 01824 | Parastrappi Mozzi Grimeca Diam.83 4 Fori | 621201936 |
| 01825 | Parastrappi Mozzi Grimeca Diam.88 4 Fori Tipo Mb | 621200202 |
| 01826 | Parastrappi A Stella Mozzi Grimeca Diam.108 | 621300130 |
| 01827 | Parastrappi Mozzi Grimeca Diam.108 4 Fori | 62120174 |
| 01831 | Parastrappi A Stella Diam. 108 Mm. | |
| 01833 | Parastrappi Mozzi Grimeca Diam.127 4 Fori | 621200173 |
| 01843 | Parastrappi A Stella Mozzi Grimeca Diam.179 Spessore 20 Mm. | |
| 01843/A | Parastrappi A Stella Mozzi Grimeca Diam.179 Spessore 14 Mm. | 621306595 |



☆ 00635/36



☆ 00574

GRIMECA



☆ 01803



☆ 01843
01843/A



☆ 01823



☆ 01826



☆ 01827



☆ 01807



☆ 01833



☆ 01824



☆ 01831



☆ 01825

| <i>Articolo</i> | <i>Descrizione</i> | <i>Simile al Nr. Orig.</i> |
|-----------------|---|----------------------------|
| 00102 | Paraolio Aste Valvole Galletto | |
| 00401/02 | Paio Ginocchiere Super Alce | |
| 00415/16 | Paio Ginocchiere Per Bauletto Galletto | |
| 00503 | Copripedale Passeggero Foro Diam.18 Lungh.107 | |
| 00513 | Coprileva Cambio | |
| 00514 | Paio Copripedali Guidatore Sport 15 Bordo Ovale | |
| 00515 | Copripedale Guidatore | |
| 00546 | Copripedale Guidatore | |
| 00546/A | Copripedale Guidatore Zigolo | |
| 00554 | Copripedale Passeggero | |
| 00567 | Coprileva Cambio Melior Doppio | |
| 00568 | Coprileva Cambio Melior Semplice | |
| 00586 | Copripedale Guidatore Cardellino 65 Cc. Foro Rettangolare | |
| 01523 | Copripedale Guidatore Cardellino - Lodola | 55443200 |
| 01568 | Copripedale Guidatore Dingo-Stornello Diam.13 | 40443200 |
| 01573 | Copripedale Passeggero Stornello - V7 | 55443385 |
| 02510 | Coprileva Cambio V 50 - 850 - 1000 | 14251001 |
| 02511 | Copripedale V50 - 850 - 1000 | 14443200 |
| 02524 | Copripedale Guidatore 850 T5 Lario | 28443201 |
| 02525 | Copripedale Passeggero 850 T5 Lario | 28443300 |
| 05962 | Passacavo Ad Occhiello | 13436561 |
| 05989/A | Tampone Ancoraggio Serbatoio | 39103400 |



05962



05989/A



★ 00401/02



★ 00415/16



★ 00503



01568



01573



★ 00515



★ 00514



★ 00546/A



★ 00546



00554



★ 00567



★ 00568



★ 00513



★ 00586



01523



★ 00102



02510



02511



02524



02525

| <i>Articolo</i> | <i>Descrizione</i> | <i>Simile al Nr. Orig.</i> |
|-----------------|--|----------------------------|
| 00513/A | Coprileva Freno Zigolo | |
| 00526 | Coprileva Freno Standard Foro Rettangolare 32 X 6 | |
| 00556 | Coprileva Selettore Cambio Galletto E 250 Cc - Foro Tondo | |
| 00557 | Coprileva Avviamento Galletto - Foro Passante Diam. 13 Mm | |
| 00601/02 | Paio Manopole - Foro Passante Mm.24-Foro Cieco Mm.21 | |
| 00602 | Paio Manopole Guzzi Foro Cieco Mm.21 | |
| 00602/661 | Paio Manopole Lodola 175 Cc. Sport Diam.21/24 | |
| 00603 | Paio Manopole Foro Passante Mm.27 | |
| 00603/05 | Paio Manopole Foro Passante Mm.27-24 | |
| 00604 | Paio Manopole Foro Cieco Mm.24 | |
| 00604/03 | Paio Manopole Foro Cieco Mm.24 - Foro Passante Mm.27 | |
| 00604/05 | Paio Manopole Foro Cieco Mm.24 - Foro Passante Mm.24 | |
| 00605 | Paio Manopole Foro Passante Mm.24 | |
| 00613 | Paio Manopole Manubrio Posteriore Superalce | |
| 00677 | Paio Manopole Cardellino - Zigolo - Stornello - Lodola | |
| 00677/A | Paio Manopole Galletto | |
| 00695 | Paio Manopole Diam.22-24 In Neoprene | 14603000/3500 |
| 00802 | Parastrappi Sport/15 | 08336800 |
| 00803 | Premistoppa Dinamo 250-500 Cc. - Mm.34,5 X 22 X 10 | |
| 00807 | Parastrappi Galletto 160-175-192 - Airone 250 1947/1948 - Airone Sport 1949/1952 - Zigolo 98 | T-2206 |
| 00809 | Parastrappi Alce | |
| 00815 | Paracolpi Sospensione Anteriore Galletto Diam.24 X 10 X 9 | |
| 00815/A | Paracolpi Sospensione Anteriore Galletto Diam. 27,5 X 9 X 9 | |
| 00815/B | Paracolpi Asta Forcella Galletto 192/59-62 Diam. 24x12x9 | |
| 00816 | Anello Fine Corsa Sospensione Anteriore Galletto 37x14x15 | |
| 00826 | Paracolpo Arresto M/Moto Zigolo Gambo Diam.12 | |
| 00826/A | Paracolpo Arresto M/Moto Zigolo Gambo Diam.7 | |
| 00835 | Boccola Attacco Ammortizzatore Anteriore Galletto | |
| 00835/A | Boccola Perni Biscottini Asta Galletto | 93110129 |
| 01535 | Coprileva Cambio Lungh. 46 Foro Passante Diam. 10 - Lodola 175 Cc - V7 - Nuovo Falcone 1972 | |
| 01591 | Copripedale Guidatore Lungh. 94 Foro Cieco A Sezione Ovale | |
| 01842 | Parastrappi Frizione Trotter | |
| 07976 | Manicotto Carburatore-Filtro Stornello | 54114301 |



00556



00557



01535



★ 00513/A



★ 00601/02
00602
00602/661



★ 00603
00603/05
00604



★ 00605
00604/03
00604/05



★ 00613



★ 00677
00677/A



00695



★ 00802



★ 00809



★ 00803



★ 00807



★ 00815/A



★ 00815
00815/B



★ 00816



★ 00826/A



★ 00826



★ 00835
00835/A



★ 01842



★ 01591



★ 07976



★ 00526

| <i>Articolo</i> | <i>Descrizione</i> | <i>Simile al Nr. Orig.</i> |
|-----------------|--|----------------------------|
| 00804 | Parastrappi 500 Cc | |
| 00842 | Parastrappi Lodola 175 Cc. | 93110200 |
| 00851 | Premistoppa Dinamo Ercole - Astore - Alce | |
| 00851/A | Premistoppa Dinamo Ercole-Astore-Falcone (35x25x5) | |
| 00853 | Premistoppa Aste Valvole Astore - Alce | |
| 00853/A | Premistoppa A Soffietto Aste Valvole 500 Cc. | |
| 00853/AS | Premistoppa A Soffietto Aste Valvole In Silicone | |
| 00858/A | Premistoppa A Soffietto Aste Valvole Airone 250 Cc. | |
| 00858/AS | Premistoppa A Soffietto Aste Valvole Airone 250 Cc. Silicone | |
| 00868/A | Premistoppa Dinamo Airone | |
| 00899 | Guarn. Ammort. Post. 250-500 Cc. Diam. 20x11x3,5 Mm | |
| 00905 | Soffietto Sospensione Anteriore 250 Cc. | |
| 02509 | Tappeto Pedana V7 California | 13447040 |
| 02855 | Anello Paraolio Forcella Anteriore 250-500 Cc.20,5x12,5x3,5 | |
| 03855 | Guarnizione Tappo Testa 250-500 Cc. Diam.39x32x2 | |
| 04871 | Cilindretto Elastico Per Coppia Trasmissione Cardellino 73cc | |
| 04893 | Cilindretto In Gomma Per Ingranaggio Distribuzione Lodola | |
| 04894 | Cilindretto Gomma Per Pignone Conico Albero Motore Lodola | |
| 04913 | Soffietto Uscita Cavi | 17755300 |
| 06852 | Guarniz. Nella Bronzina Preselettore Lodola 175 Cc. Sport | |
| 06853 | Guarnizione Nella Testa Per Asta Tendicatena Lodola | |
| 06870 | Paraolio Aste Valvole Stornello | |
| 06870/A | Paraolio Aste Valvole Stornello Sport | |
| 06870/AS | Paraolio Aste Valvole Stornello Sport - Silicone - | |
| 06871 | Guarnizione Tirante Cilindro Stornello Foro Mm.7,5 | |
| 06871/S | Guarnizione Tirante Cilindro Stornello - Silicone - | |
| 06872 | Guarnizione Tirante Cilindro Stornello Foro Mm.10 | |
| 06872/S | Guarnizione Tirante Cilindro Stornello - Silicone - | |
| 06873 | Guarnizione Fine Corsa Forcella Lodola - Diam. 41x29x5,5 Mm. | |
| 07942 | Tappo Chiusura Fori Portabagaglio | 93180060 |
| 07954 | Bussola Fissaggio Contagiri 1000 GS | 91551165 |
| 10850 | Guarnizione Per Tubo Copri Astine Nuovo Falcone 500 Cc. | 10022800 |
| 10931 | Cappuccio Connettore Maschio a 4 Vie | 17756060 |
| 12926 | Collettore Carburatore Filtro V7 Ii Serie | 12114301 |
| 12927 | Collettore Carburatore Filtro V7 I Serie 700 Cc | 12114300 |



☆ 00804



☆ 00842



☆ 00851/A



☆ 00851



☆ 00853



☆ 00868/A



☆ 06853



☆ 00858/A
00858/AS



☆ 00853/A
00853/AS



☆ 06870/A
06870/AS



☆ 06870



☆ 06852



☆ 10850



☆ 06871
06871/S



☆ 06873



☆ 03855



☆ 02855



☆ 00899



☆ 04894



☆ 04871



☆ 04893



☆ 06872
06872/S



04913



10931



07954



07942



☆ 02509



☆ 00905



☆ 12927



☆ 12926

| <i>Articolo</i> | <i>Descrizione</i> | <i>Simile al Nr. Orig.</i> |
|-----------------|--|----------------------------|
| 00900 | Guarnizione Ammortizz. Post. 250-500 Cc. Diam. 28x22x3 Mm | |
| 00923/A | Cappuccio A Pipa | |
| 01903 | Guarnizione Tappo Serbatoio Benzina Guzzino 65 Cc. 47x37x2,5 | |
| 01904 | Guarnizione Tappo Serbatoio Benzina Diam. 44x37x3 Mm. | |
| 02902 | Blocchetto Forcellone Oscillante Cardellino 65-73 Cc | |
| 02902/A | Blocchetto Forcellone Super Alce | |
| 02911 | Tappo Protezione Arresto Manubrio Galletto 192 Cc. | |
| 02929 | Boccola Fissaggio Serbatoio Lodola 175 Cc./V7 700 Cc. | 55103425 |
| 02934 | Passacavo Sul Cruscotto Galletto | |
| 02936 | Guarnizione Per Filtro Carburatore Galletto 175 Cc. | |
| 02937 | Guarnizione Filtro Carburatore Galletto 192 Cc. | |
| 02938 | Guarnizione Tappo Serbatoio Tebaldi Diam. 55x30x5 | |
| 02999 | Rullino Per Forcella Lodola Diam.25x8x18 | |
| 02971 | Boccola Ammortizzatore Mm 12 X 25 X 11 - Stornello | 13619633 |
| 03902 | Boccola Ammortizzatore Mm 26 X 15 X 13 | 18551650 |
| 04922 | Passacavo Per Guscio Di Protezione Zigolo 110 Cc. | |
| 05904 | Boccola Attacco Motore Trotter | |
| 05909 | Tampone Arresto Leva Messa In Moto | |
| 05947 | Guarnizione Tappo Serbatoio Benzina Stornello | |
| 05950 | Boccola Attacco Anteriore Serbatoio Dingo | |
| 05959 | Calotta Forcella Diam.30 Per Scrambler | |
| 05960 | Calotta Forcella Diam 33 | 14524500 |
| 06910 | Tappo Ispezione Ingranaggi V 7 | 93180220 |
| 06937/A | Manicotto Carburatore V50/Iii Monza | 19114380 |
| 06952 | Manicotto Carburatore Diam.25 | 61114300 |
| 06952/A | Manicotto Carburatore V35-50 Imola Diam.27 | 62114300 |
| 06952/C | Manicotto Carburatore Bc 750 Diam.27 | 63114300 |
| 06955 | Manicotto Carburatore Diam.30 | |
| 06955/A | Manicotto Carburatore Diam.34 | |
| 06955/B | Manicotto Carburatore Diam.36 | 14114350 |
| 06955/C | Manicotto Carburatore Diam.40 | 28114340 |
| 07934 | Cappuccio Commutatore A Chiave V7 S5-Le Mans | 14735800 |
| 07938 | Cappuccio Pompa Freno A Disco 250 Ts | 39663801 |
| 07939 | Anello Inferiore Parapolvere Cuscinetti V7 | 14517000 |
| 07945 | Tampone Appoggio Serbatoio Sella E Trousse V7 S5 | 14103800 |
| 07946 | Calotta Di Fermo Sul Puntale V7 S5 | 14423800 |
| 07949 | Bussola Conica Tenuta Olio Asta Frizione V7 Sport-Le Mans | 14085900 |
| 07955 | Tampone Laterale Appoggio Serbatoio V7 S5 | 14109000 |



☆ 00900



☆ 01904



☆ 01903



07939



☆ 02936



☆ 02929



☆ 02934



☆ 02971



☆ 07945



02999



☆ 03902



☆ 02938



☆ 02937



07955



00923/A



07938



☆ 05909



☆ 05947



☆ 05950



☆ 02911



☆ 06910



☆ 05904



☆ 07946



☆ 04922



☆ 07949



06952
06952/A



06952/C



06937/A



06955
06955/A
06955/B
06955/C



☆ 02902



☆ 05959



05960



☆ 07934



☆ 02902/A

| <i>Articolo</i> | <i>Descrizione</i> | <i>Simile al Nr. Orig.</i> |
|-----------------|---|----------------------------|
| 01807 | Parastrappi Mozzo Campagnolo-Grimeca Per Zigolo - Stornello | 24336800 |
| 04911 | Soffietto Protezione Cavo Freno Anteriore V7 Sport | 12626300 |
| 04974 | Soffietto Forcella Stornello 120-160 Cc - Dingo Cros - Super - Gt | |
| 05922/V | Or In Viton | |
| 06964 | Tampone Borsette 125 - 250 2c | |
| 07933 | Copriregistro Trasmissione V 850 T3 | 17093850 |
| 07957/A | Cappuccio Interruttore Stop Diam.19 . Cavo Diam. 6 | |
| 07958 | Pipetta Recupero Olio 850 T3 | 17154950 |
| 07959 | Pipetta Sfiato Olio 850 T3 | 17154850 |
| 07960 | Collettore Aspirazione 850 T3 | 17114350 |
| 07962 | Custodia Contagiri/Km V7 S5 | 14762001 |
| 07963 | Vaschetta Batteria | 14707000 |
| 07967 | Protezione Cavo Comando Freno Anteriore V7 S5 | 14626300 |
| 07973 | Collettore Aspirazione | 14114300 |
| 07991 | Soffietto Giunto Cardanico V7 | 12548000 |
| 07992 | Soffietto Giunto Cardanico V7 Convert | 18548000 |
| 08929 | Soffietto Giunto Cardanico V35-V50 | 19548001 |
| 10880 | Serie Parastrappi Ruota Posteriore V 35 (Confezione Da 12 Pezzi) | 19632501/02 |
| 10883 | Serie Parastrappi Ruota V7-Sport '74 - 850T/T3 (Confezione Da 12 Pezzi) | 14336803 |



07933



☆ 01807



05922/V



☆ 06964



07957/A



☆ 07967



10883



07959



07958



07962



04974



☆ 04911



08929



10880



07992



07991



07973



07960



07963

| <i>Articolo</i> | <i>Descrizione</i> | <i>Simile al Nr. Orig.</i> |
|-----------------|---|----------------------------|
| 00692/A | Paio Manopole 22-24 Modelli Anni 70-80 | |
| 01582 | Coprileva Cambio Lungh. 39 Foro Passante Diam.7 | |
| 01589 | Coprileva Avviamento Lungh.73 Foro Passante Diam.11 | |
| 01612 | Paio Manopole In Gomma Lungh. 130 Mm | |
| 01612/A | Paio Manopole In Pvc Lungh. 130 Mm | |
| 01612/SS | Paio Manopole In Supersoft Lungh. 130 Mm | |
| 01614/A | Paio Manopole 22-24 Off Road | |
| 01661/SSF | Paio Manopole In Supersoft - Fondello Forato - Lungh.120 Mm | |
| 01682/SSF | Paio Manopole In Supersoft - Fondello Forato - Lungh.125 Mm | |
| 01686/SSF | Paio Manopole In Supersoft - Fondello Forato - Lungh.120 Mm | |
| 02522 | Coprileva Cambio | 24781419000 |
| 02523 | Coprileva Cambio | 24781449000 |
| 02534 | Pedana Guidatore + Pass. Honda Nsr 125 / Revere 600 Guidat. | 50661MJ4670 |
| 09981 | Paio Soffietti Colore Nero - Transalp 600 | |
| 10942 | Silentblock Marmitta | 18355-KS6-000 |
| 10953 | Paio Soffietti Forcella Scooter Honda Sh 50-80 Scoopy | |
| 12993 | Tampone Fermo Cavalletto Honda Sh - Cbr 600 Rr3 | 50505-GR1-000 |



☆ 00692/A



01582



01589



12993



01612
01612/SS
01612/A

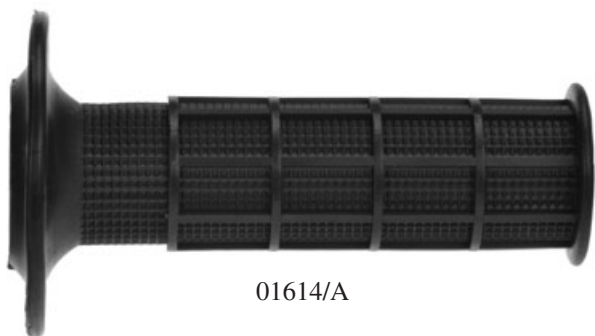

01614/A



01661/SSF



01682/SSF



01686/SSF



02522



02523



02534



10942



09981



10953

| <i>Articolo</i> | <i>Descrizione</i> | <i>Simile al Nr. Orig.</i> |
|-----------------|---|----------------------------|
| 00508/A | Copripedale Guidatore Isomoto Diam. 14 | |
| 00508/C | Copripedale Guidatore Diam.14 | |
| 00512 | Coprileva Cambio Isomoto Foro Diam.10 | |
| 00583 | Coprileva Cambio Isoscooter 125 Cc. | |
| 00584 | Coprileva Freno Isoscooter 125 Cc. | |
| 00585 | Coprileva Avviamento Isoscooter 125 Cc. | |
| 00589 | Paio Staffe Per Passeggero | |
| 01540 | Coprileva Avviamento Isoscooter 150 Cc. | |
| 01541 | Coprileva Freno Isoscooter 150 Cc. | |
| 01550 | Scarpetta Cavalletto Isoscooter 150 Cc. | |
| 01928 | Tampone Arresto Forcella Posteriore E Leva Avviamento | |
| 01970 | Soffietto Sospensione Anteriore | |
| 01971 | Tappo Per Forcella | |
| 01975 | Guarnizione Supporto Portapacchi | |
| 03991 | Soffietto Aspirazione Scooter 150 Cc. | |



★ 00508/C



★ 00585



★ 00512



★ 01971



★ 00584



★ 01541



★ 01540



★ 01975



★ 00589



★ 01550



★ 01928



★ 00508/A



★ 03991



★ 01970



★ 00583

| <i>Articolo</i> | <i>Descrizione</i> | <i>Simile al Nr. Orig.</i> |
|-----------------|---|----------------------------|
| 01585 | Coprileva Cambio Lungh.44 Foro Passante Diam.9 | |
| 01679/SSF | Paio Manopole In Supersoft Lungh. 120 Mm - Forate | |
| 01685/SSF | Paio Manopole In Supersoft Lungh. 120 Mm - Forate | |
| 02625/SSF | Paio Manopole In Supersoft Lungh. 120 Mm - Forate | |

KREIDLER

| <i>Articolo</i> | <i>Descrizione</i> | <i>Simile al Nr. Orig.</i> |
|-----------------|--|----------------------------|
| 00697 | Paio Manopole Ciclomotore | |
| 01584 | Coprileva Avviamento | 156062 |
| 01609/A | Paio Manopole 22-24 Comando Magura | |
| 01611 | Paio Manopole 22-24 Comando Magura | |
| 02514 | Coprileva Cambio | 155016 |
| 02515 | Appoggiapiede Guidatore Diam. Int. 16 Mm | |
| 02515/A | Appoggiapiede Guidatore Diam. Int. 18 Mm | 51310004 |
| 02801 | Parastrappi Ruota Posteriore | 061577 |
| 02805 | Parastrappi Singolo Ruota Posteriore | |
| 06990 | Soffietto Forcella | 570613 |
| 07982 | Tappo Carter Catena | |
| 08940 | Tappo Carter Catena | 150210 |
| 08941 | Boccola | 030402 |
| 08967 | Soffiettino Cavi | 2151306 |



01679/SSF



01585



01685/SSF



02625/SSF

KREIDLER



★ 00697



01609/A



★ 01611



★ 02515
02515/A



02514



★ 02805



★ 07982



★ 08940



★ 08941



01584



★ 02801



08967



★ 06990

| <i>Articolo</i> | <i>Descrizione</i> | <i>Simile al Nr. Orig.</i> |
|-----------------|---|----------------------------|
| 00525 | Coprileva Freno Lambretta C | 3T714 |
| 00530 | Coprileva Avviamento Mod.B E Mod.C | 3M436 |
| 00552 | Copripedale Motocarro 1^ Serie | |
| 00618 | Paio Manopole Lambretta B - Colore Grigio | 3ST413 |
| 00625 | Paio Manopole Lambretta C E D - Foro Passante Diam.26 | 6ST410 |
| 00625/A | Paio Manopole Con Paramano Mod C E D - Foro Diam.26 | |
| 00648 | Paio Manopole Lambretta D-Ld 1953 Diam.25 | 96206 |
| 00649 | Paio Manopole Lambretta D-Ld 1953 Diam.27 | |
| 00656 | Paio Manopole Con Paramani D/150-Ld-F Diam. 27 Mm. | 7770403 |
| 00660 | Paio Manopole Ciclomotore Lambretta Diam.24-24 | 14060206 |
| 00668 | Paio Manopole Bombate Diam.24 Grigio | |
| 00668/A | Paio Manopole Bombate Diam.21 Grigio | |
| 00670 | Paio Manopole Li Nero | 19062616 |
| 00670/B | Paio Manopole Lambretta J-50 Diam. 14 | 30011001 |
| 00670/B-GR | Paio Manopole Lambretta Junior Diam.14 Grigio | 20011001 |
| 00670-GR | Paio Manopole Li Grigio | 19062616 |
| 00679 | Paio Manopole Li 3^ Serie 24/24 Nero | 22062016 |
| 00679-GR | Paio Manopole Li 3^ Serie 24/24 Grigio | 19962016 |
| 00864 | Paracolpi Fiancate Con Vite Incorporata Mod. Ld | 121910061 |
| 00884 | Guarnizione Tappo Serbatoio Benzina Mm. 42 X 32 X 2 | 99097007 |
| 00913/A | Cappuccio Presa Bassa Tensione 150 Cc. | 99098221 |
| 01548 | Coprileva Freno Li 150 Cc. | 220059003 |
| 01548-GR | Coprileva Freno Li 150 | 15059003 |
| 02859 | Guarnizione Tenuta Perno Ruota 150 Cc. | 2160137 |



★ 00648
★ 00649

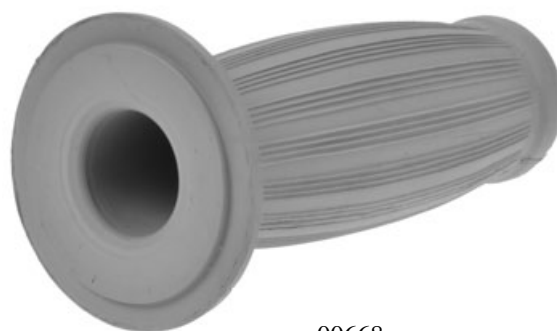

★ 00668
★ 00668/A

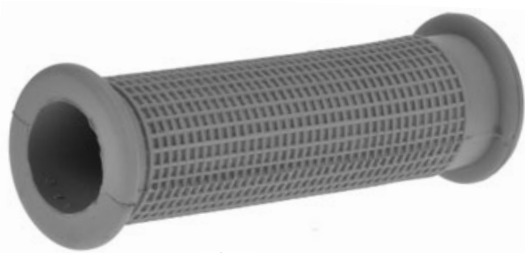

★ 00618



★ 00625/A



★ 00913/A



★ 00625



★ 00656



★ 02859



★ 00884



★ 00660



★ 00552



★ 00530



★ 00670/B

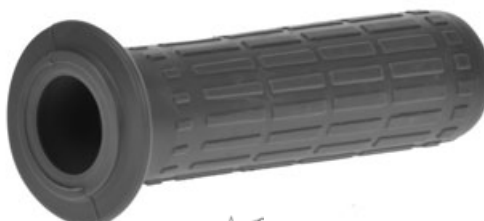

★ 00670/B-GR



★ 01548/GR



00670

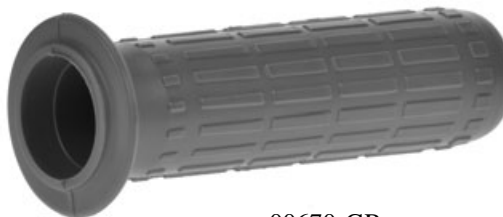

00670-GR



★ 01548



★ 00525



00679



★ 00679-GR



★ 00864

| <i>Articolo</i> | <i>Descrizione</i> | <i>Simile al Nr. Orig.</i> |
|-----------------|---|----------------------------|
| 00919 | Guarnizione Per Vetro Faro Anteriore Diam. 85 Mm. | |
| 00919/A | Guarnizione Per Vetro Faro Anteriore Diam. 70 Mm. | |
| 00920 | Guarnizione Per Vetro Faro Anteriore Diam. 95 Mm. | 99098006 |
| 00920/A | Guarnizione Vetro Faro Anteriore Diam. 130 Mm. | |
| 00924 | Pipetta Capocorda Candela | 2A501 |
| 00940 | Cappuccio Protezione Molleggio Anteriore Mod. C-Lc | 6ST121 |
| 00947 | Collare Di Guarnizione Per Tappo Serbatoio Benzina | 25115 |
| 00947-GR | Collare Di Guarnizione Per Tappo Serbatoio Benzina -Grigio- | 25115 |
| 00955 | Tappo Grigio Portello Ispezione Mod. Lc-Ld | 5T240 |
| 00956 | Cappuccio Gancio Scudo Mod. Lc-Ld | 5T235 |
| 00958 | Boccola Per Guaina Uscita Fili | 06770214 |
| 00959 | Tampone Sospensione Posteriore | 6TR515 |
| 00968/69 | Paio Tappetini Grigio Tutta Gomma Dx-Sx Mod.Lc | 8181241 |
| 01905 | Anello Di Guarnizione Diam. 22 Mm. Corda 1,8 | 19030032 |
| 01906 | Tamponcino Parafango Anteriore Mod.D | 7180302 |
| 01908 | Tampone In Gomma Fine Corsa Molleggio Anteriore D-Ld | 99106052 |
| 01908/A | Tampone Gomma Fine Corsa Molleggio Posteriore D-Ld | 40770113 |
| 01909 | Tampone Parafango Anteriore Mod.D | 15060039 |
| 01915 | Tampone Di Fine Corsa Molleggio Posteriore D-Ld 150 Cc. | 71800616 |
| 01918/A | Tampone In Gomma Per Molleggio Motore D-Ld | 7111016 |
| 01919 | Coprileva Avviamento Mod. D 125 Cc. | 7110437 |
| 01919/A | Copripedale Avviamento Tipo E - Ld/1953 | 7110637 |
| 01946 | Maniglia M/Moto Lambretta E Colore Grigio | 91309 |
| 01946-N | Maniglia M/Moto Lambretta E Colore Nero | |
| 01948 | Tampone Fine Corsa Molleggio Mod. E-F | 95032 |
| 01949 | Anello Per Astina Frizione Diam. 7 X 7 Mm. | 92015 |
| 01952 | Paracolpo Ad U Per Sterzo | 96022 |
| 01954 | Coprifreno Lambretta D-Ld 150 Grigio | 99095906 |
| 01955 | Protezione Guaina Grigio Comando Cambio | |
| 01957 | Protezione Guaina Grigio Comando Gas | |
| 01984 | Cappuccio Porta Guaina Gas Al Carburatore Mod. D | 412053 |



☆ 00920/A



☆ 00920



☆ 00956



☆ 00924



☆ 00940



☆ 01909



☆ 00947-GR



☆ 00947



☆ 00955



☆ 00958



☆ 01905



☆ 01906



☆ 01908/A



☆ 01908



☆ 01948



☆ 00968/69



☆ 01915



☆ 00959



☆ 00919



☆ 00919/A



☆ 01952



☆ 01919



☆ 01919/A



☆ 01946-N



☆ 01946



☆ 01954



☆ 01918/A



☆ 01949



☆ 01955



☆ 01957



☆ 01984

| <i>Articolo</i> | <i>Descrizione</i> | <i>Simile al Nr. Orig.</i> |
|-----------------|--|----------------------------|
| 02903-K | Profilo Grigio Per Pedana Ld - A Peso | 8180140 |
| 02903-K-N | Profilo Nero Per Pedana Ld - A Peso | 8180140 |
| 02907 | Coprileva Avviamento Mod.D 150 Cc. | 11110437 |
| 02912 | Cappuccio Gomma Antiolio Gancio Carenatura Ld 150 Cc. | 15055046 |
| 02915 | Coprileva Avviamento 150 Cc. 1955 | 12110438 |
| 02915/A | Coprileva Avviamento Mod. Ld 1957 Prima Serie | 12110436 |
| 02915/B | Coprileva Avviamento Mod. Ld 1957 Seconda Serie | 12110426 |
| 02915/C | Coprileva Avviamento Mod. Li 1° Serie | 15041033 |
| 02915/D | Coprileva Avviamento Li 2^ Serie | 19030037 |
| 02915/E | Coprileva Avviamento Li 3^ Serie | 19030042 |
| 02915/E-GR | Coprileva Avviamento Li 3^ Serie - Grigio - | 19030042 |
| 02915/F | Protezione Leva Avviamento Fli-Lambro 200 | |
| 02915/G | Coprileva Leva Avviamento 100-125 Junior | 2054011 |
| 02939 | Soffietto Parapolvere Per Albero Trasmissione Fd 150 Cc. | 18331107 |
| 03907 | Scarpetta Per Cavalletto Li 1/2/3^ Serie - Tv | 15057020 |
| 03907/A | Scarpetta Per Cavalletto Junior | 20032020 |
| 03907-GR | Scarpetta Cavalletto - Grigio - Li 2a-3a Serie - Tv | 15057020 |
| 03915 | Tampone Fermo Cavalletto | 15057007 |
| 03916 | Tubo Collegamento Carburatore 48 Cc. | 14010604 |
| 03928 | Distanziale Per Fiancata | 15050065 |
| 03934 | Guarnizione Tappo Serbatoio Li Diam. 42 X 27,5 X 3 Mm. | 15070021 |
| 03951 | Tampone Per Bauletto | 15086009 |
| 03953 | Tampone Per Parafango Posteriore | 1505057 |



★ 02903-K
★ 02903-K-N



★ 03915



★ 03953



★ 02912



★ 02915/A



★ 02915/B



★ 02915/C



★ 02915/D



★ 02915/E-GR



★ 02915/E



★ 02915/F



★ 02915



★ 02907



★ 02915/G



★ 03907/A



★ 03907



★ 03907-GR



★ 03916



★ 02939



★ 03928



★ 03934



★ 03951

| <i>Articolo</i> | <i>Descrizione</i> | <i>Simile al Nr. Orig.</i> |
|-----------------|--|----------------------------|
| 00972 | Tappo Per Fori Supporto Ruota Di Scorta | |
| 00972/A | Tappo Con Gambo Lungo Per Fori Supporto Ruota Di Scorta | |
| 00972/A-GR | Tappo Con Gambo Lungo Per Fori Supporto Ruota Di Scorta - Grigio | |
| 00972-GR | Tappo Per Fori Supporto Ruota Di Scorta - Grigio | |
| 03914 | Soffietto Cuffia Carburatore Ld 125-150 Cc. | 12110716 |
| 03917/A | Paio Profili Per Scudo Li 3 [^] Serie - Nero | 22050062 |
| 03917/A-GR | Paio Profili Per Scudo Li 3a Serie - Grigio | 19950073 |
| 03917/A-K | Profilo Per Scudo Li 3a Serie - Nero - al Kg. | |
| 03917/AKGR | Profilo Per Scudo Li 3a Serie - Grigio - al Kg. | |
| 03936 | Paio Spezzoni Profilo Fiancata Li 150 Cc. Nero | 15055059 |
| 03936-K | Profilo Fiancata al Kg. Nero | 15055059 |
| 03936-GR | Paio Spezzoni Profilo Fiancata Li 150 Cc. Grigio | 15050046 |
| 03936-KGR | Profilo Fiancata Al Kg. Grigio | 19022015 |
| 03954 | Tampone Supporto Sostegno Serbatoio | 15050021 |
| 03959 | Membrana Presa Aria Carburatore Mod. Tv 175 Cc. | 412213 |
| 03960 | Tampone Di Fine Corsa Li 150 Cc. | 19010036 |
| 03961 | Passacavo Rubinetto Benzina Li | |
| 03983 | Soffietto Aspirazione Carburatore Li 2 [^] Serie | 19016021 |
| 03983/A | Soffietto Aspirazione Carburatore Li 3 [^] Serie | 19916022 |
| 03983/B | Soffietto Aspirazione Carburatore Junior | 20055004 |
| 04909 | Soffietto Protezione Cavi Li | |
| 04949 | Protezione Comando Freno Posteriore Li 150/175 Cc. - Tv | |
| 04969 | Tampone Serbatoio | |
| 04981 | Parapolvere Ceppi Freno Lambro | |
| 05868 | Anello Tenuta Mozzo Anteriore Li Diam. 58x47x5 | |
| 05869 | Guarnizione Ad Anello Per Albero Secondario Cambio Li | |
| 05870 | Guarnizione Ad Anello Per Albero Leva Comando Cambio Tv | |
| 05871 | Anello Or Per Comando Frizione E Cambio Li (= 00330) | |
| 05873 | Guarnizione Ad Anello Per Canna Ruota Posteriore Li | |
| 05907 | Scarpetta Cavalletto Lui | |
| 09986 | Griglia Freno Bianca | 19744068 |
| 10904 | Tampone Molleggio Anteriore | 15060100 |
| 10907 | Tampone Molleggio Anteriore Grande | 15060070 |



★ 03954



★ 03960



03961



04969



03936
★ 03936-K
03936-GR
03936-KGR



★ 04981



★ 05868



★ 05869



★ 05870



★ 05871



★ 05873



★ 10904



★ 10907



04949



★ 09986



★ 05907



★ 03917/A
★ 03917/A-K
★ 03917/A-GR
★ 03917/AKGR



★ 00972/A-GR



★ 00972/A



★ 00972



★ 00972-GR



03914

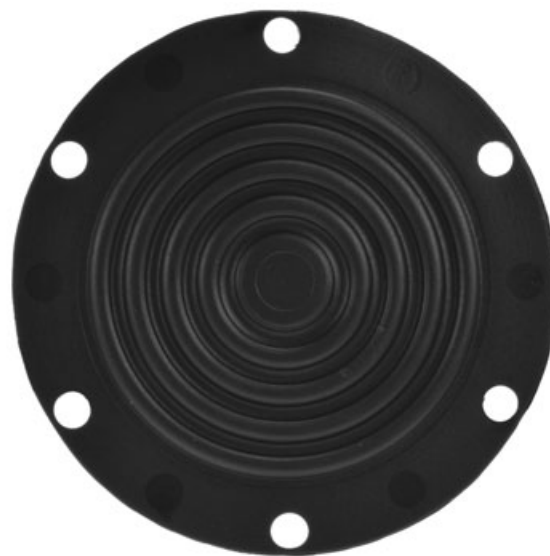

★ 03959



★ 03983/B



★ 03983/A



04909



★ 03983

| <i>Articolo</i> | <i>Descrizione</i> | <i>Simile al Nr. Orig.</i> |
|-----------------|--|----------------------------|
| 00518 | Appoggiapiede Passeggero Tipo B | |
| 03949 | Paio Profili Lambretta Grigio | 15059022 |
| 04910 | Soffietto Protezione Cavi Fli | |
| 04911 | Protezione A Soffietto Cavi Comando Cambio Fli | |
| 04984 | Soffietto Aspirazione DI 150/200 | |
| 04985 | Soffietto Aspirazione DI 125 | |
| 09984 | Guarnizione Scatola Filtro Lambretta Dal 1961 (Tutti I Tipi) | |
| 09987 | Profilo Bauletto Nero Li 1-2-3 [^] Serie - Sx - Tv - Gp | |
| 10946 | Profilo Nero Raccordo Pedana Li/Tv Lungh. Cm 45 | |
| 10946-GR | Profilo Grigio Raccordo Pedana Li/Tv Lungh. 45 Cm | |
| 10951 | Paio Profili Neri Scudo/Frontale Lambretta Gp - DI | 19950046 |



☆ 00518



☆ 04910



☆ 09984



☆ 09987



☆ 04985



☆ 04984



☆ 04911



☆ 03949



☆ 10951



☆ 10946-GR



☆ 10946

| <i>Articolo</i> | <i>Descrizione</i> | <i>Simile al Nr. Orig.</i> |
|-----------------|---|----------------------------|
| 03992 | Soffietto Aspirazione Carburatore Fli 175 Cc. | |
| 04970 | Manicotto Aspirazione Lambro 450-500 2^ Tipo | |
| 04970/A | Manicotto Aspirazione Lambro 450-500 | |
| 04970/B | Manicotto Aspirazione Lambro 550/V 1^ Tipo | |
| 04970/C | Manicotto Aspirazione Lambro 550/V 2^ Tipo | |

LAVERDA

| <i>Articolo</i> | <i>Descrizione</i> | <i>Simile al Nr. Orig.</i> |
|-----------------|---|----------------------------|
| 00558 | Copripedale Guidatore e Passeggero 200 Cc. Bicilindrico | 358/B |
| 00558/A | Copripedale Guidatore Con Marchio In Rilievo | 403 |
| 00582 | Coprileva Selettore Foro Piatto Passante | |
| 00658 | Paio Manopole con Marchio 100 Cc. - Diam. 22-24 - La Destra ha Bordo Paramano | 538/539 |
| 00676 | Paio Manopole Per Scooter | 326/A |
| 01521 | Coprileva Selettore Cambio 100 Cc. | 253/CL1 |
| 01522 | Coprileva Freno 100 Cc. | 527/CL1 |
| 01549 | Scarpetta Cavalletto Scooter | 220/A |
| 01559 | Coprileva Freno 200 Cc. Bicilindrico | |
| 01560 | Copripedale Passeggero Scooter | 221/A |



☆ 03992



☆ 04970/A



☆ 04970/B



☆ 04970/C



☆ 04970

LAVERDA



☆ 00558/A



☆ 00558



☆ 01560



☆ 00582



☆ 01521



☆ 01522



☆ 01559



☆ 01549



☆ 00658



☆ 00676

| <i>Articolo</i> | <i>Descrizione</i> | <i>Simile al Nr. Orig.</i> |
|-----------------|---|----------------------------|
| 00692/A | Paio Manopole 750 - 1000 Cc fino Agli Anni 90 | 60403991/60404992 |
| 00839 | Parastrappi Ruota Posteriore 75/100cc.-16,5x8x13,5 | 468 |
| 00839/A | Parastrappi Ruota Posteriore 100 Cc.1958-16,5x9x14 | |
| 01561 | Coprileva Selettore Cambio 200 Cc. Bicilindrico | 245/B |
| 01578/C | Appoggiapiede Guidatore Diam. 12 Mm (500 Cc) | 50404056 |
| 01580 | Appoggiapiede Guidatore 650 - 750 Cc Fino Al 1971 - Lungh. 115 Mm | 214E |
| 01580/A | Appoggiapiede Guidatore 750 Gt -Sf - Sfc - 1000 Cc dal 1972 - Lungh. 105 Mm | 50404016 |
| 02971 | Boccola Conica Ammortizzatore 100 Cc | |
| 03938 | Boccola Per Ammortizzatore Posteriore 100 Cc.- 1958-59 | |
| 03988 | Elastico Batteria Dalla 650 Alla 1000 Cc | 50403004 |
| 04931 | Gommino Per Appoggio Serbatoio 200 Cc. Bicilindrico | 449/B |
| 04932 | Supporto Marmitta 200 Cc. Bicilindrico | 358/B |
| 04933 | Protezione Uscita Fili Volano Magnete 200 Cc. Bicilindrico | 326/B |
| 04934 | Tappo In Gomma Per Appoggio Serbatoio 200 Cc. Bicilindrico | 303/B1 |
| 04935 | Paracolpi Fine Corsa Forcella Telescopica 200 Bicilindrico | 429/B |
| 04936 | Paracolpi Fine Corsa Leva Avviamento 200 Cc. Bicilindrico | 232/B |
| 04938 | Protezione Uscita Fili Volano Magnete Scooter | 260/B |
| 05933 | Soffietto Cavi Comandi | 58200191 |
| 05949 | Elastico Per Fissaggio Posteriore Serbatoio 750 Sport E Batteria 250 Cc | 50403011 |
| 05989/B | Tampone Ancoraggio Serbatoio | 50402007 |
| 05993 | Supporto Marmitta | 50402009 |
| 05995 | Paracolpi | 50402060 |
| 06997 | Paraspruzzi Tappo Serbatoio Benzina | 36210250 |
| 07977 | Soffietto Protezione | 61928085 |
| 07978 | Anello Antivibrante | 50402008 |
| 07979 | Appoggio Serbatoio | 50401006 |
| 07981 | Cappuccio Idrostop 750 Sfc | 58200105 |
| 07982 | Tappo Foro Ispezione Frizione 750 Gt/Sf- 1000 Tutti I Modelli | 58000102 |
| 07983 | Tampone Supporto Serbatoio 1000 Sc - 1000 RI | 50401070 |
| 07989 | Elastico Trousse 250 2t - 250 2tr | 50403119 |
| 10887 | Serie Parastrappi (8 Pezzi) Corona Catena 750 Sfc - 1000 Cc | 50405023 |



☆ 00692/A



01578/C



★ 01580/A



★ 01580



★ 07977



★ 07978



★ 04934



★ 04935



★ 04936



★ 05995



★ 04932



★ 05989/B



★ 05993



★ 07981



★ 07983



★ 05933



★ 06997



★ 07979



★ 10887



★ 01561



★ 04931



★ 04933



★ 04938



★ 03938



★ 00839



★ 00839/A



★ 07989



★ 07982



★ 02971



05949



03988

| <i>Articolo</i> | <i>Descrizione</i> | <i>Simile al Nr. Orig.</i> |
|-----------------|--|----------------------------|
| 04937 | Soffietto Aspirazione Carburatore Scooter | 252/A |
| 04975/A | Calotta Forcella Arces-Ceriani Diam. 32 Mm | |
| 04991 | Calotta Forcella Arces-Ceriani Diam 35 Mm | |
| 06903 | Calotta Forcella Arces-Ceriani Diam. 35 Mm | |
| 06904 | Calotta Forcella Arces-Ceriani Diam. 38 Mm | |
| 07985 | Soffietto Carburatore Filtro 1000 Tutti I Modelli - 750 Sf Lato Sinistro | 36210111 |
| 07986 | Soffietto Carburatore Filtro 1000 Tutti I Modelli - 750 Sf Lato Destro | 36210112 |

MAICO

| <i>Articolo</i> | <i>Descrizione</i> | <i>Simile al Nr. Orig.</i> |
|-----------------|---|----------------------------|
| 01507 | Coprileva Diam. 12 Mm | 1056600705 |
| 04999 | Cappuccio In Silicone | |
| 05962/A | Passacavo Ad Occhiello | 149.08.005.0.9 |
| 06902 | Tendifilo Gas Comando Magura | |
| 06936 | Manicotto Carburatore Bing 41 Mm | |
| 06996/B | Rullino Tendicatena | 336.06.052.0.4 |
| 08968 | Paio Calotte Forcella Maico Diam. 41,7 - Mod. Dal 1981 | 6441 |
| 08968/A | Paio Calotte Raschiapolvere Forcella 38 Mm Fino Al 1980 | 79390780 |
| 08969/A | Soffietto Scatola Filtro Diam. 80 Lumgh. 160 | 3357205203 |
| 08969/B | Soffietto Scatola Filtro | 3257205204 |
| 08975 | Elastico Serbatoio Maico | 3362002404 |



☆ 04975/A



☆ 04991



☆ 06903



☆ 06904



☆ 07985



☆ 07986



☆ 04937



06996/B



05962/A



01507



04999



☆ 06902



☆ 08968/A



☆ 08968



06936



08975



☆ 08969/A



☆ 08969/B

| <i>Articolo</i> | <i>Descrizione</i> | <i>Simile al Nr. Orig.</i> |
|-----------------|--|----------------------------|
| 01608/A | Paio Manopole Magura Nero | |
| 01608/A-R | Paio Manopole Magura Rosso | |
| 01803 | Parastrappi Grimeca Diam. 145 | 149.16.016.0.9 |
| 08969 | Soffietto Scatola Filtro Maico 250-400 | 343 |

MALAGUTI

| <i>Articolo</i> | <i>Descrizione</i> | <i>Simile al Nr. Orig.</i> |
|-----------------|---|----------------------------|
| 10990 | Tampone Battuta Cavalletto F10-F12-F15-Centro | 07206400 |
| 10991 | Manic. Scat.Filtro F10-F12-F15-Centro Base 93-94-SI-Crosser | 07601200 |
| 10992 | Manic.Scat.Filtro Carb.Dell'orto F10-F12-F15-Centro SI- | 07601300 |
| 10993 | Manic.Scat.Filtro Carb.Tk F10-F12-Centro Base 93-94-SI | 07601100 |

MALANCA

| <i>Articolo</i> | <i>Descrizione</i> | <i>Simile al Nr. Orig.</i> |
|-----------------|--|----------------------------|
| 00921 | Cappuccio A Pipa | |
| 01546/A | Coprileva Cambio | |
| 01562 | Copripedale Diam. Interno 14 - Marchio Malanca | |
| 01567 | Coprileva Messa In Moto | |
| 01568 | Copripedale | |
| 03944 | Boccola Ancoraggio Serbatoio Al Telaio | |
| 04999 | Cappuccio Candela In Silicone | |



☆ 01608/A
01608/A-R



08969



☆ 01803

MALAGUTI



10990



10991



10992



10993

MALANCA



01568



04999



☆ 01546/A



☆ 01562

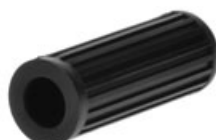

01567



☆ 03944



00921

| <i>Articolo</i> | <i>Descrizione</i> | <i>Simile al Nr. Orig.</i> |
|-----------------|---|----------------------------|
| 04986 | Calotta Forcella Meccanica Diam. 28 | 000533039 |
| 04987 | Calotta Forcella Diam. 28 | 000533002 |
| 04988 | Calotta Forcella Diam. 32 | FI0031001 |
| 04989 | Calotta Forcella Diam.35 | FI0051001 |
| 06938 | Calotta Forcella Diam. 34 | |
| 06946 | Calotta Forcella Diam.30 | FI0331001 |
| 06947 | Calotta Forcella Diam.38 | FI0521001 |
| 07905 | Paio Soffietti Forcella Diam.35/48 Lungh.280 | |
| 07906 | Paio Soffietti Nero Diam.35/48 Lungh.280 | |
| 07906-A | Paio Soffietti Blu Diam.35/48 Lungh.280 | |
| 08960 | Paio Calotte Forcella Diam.30 | 1044010020 |
| 08961 | Paio Calotte Forcella Diam.32 | 1236010001 |
| 08962 | Paio Calotte Forcella Diam.35 | 1005010020 |
| 08963 | Paio Calotte Forcella Diam.38 | 1052010020 |
| 12925 | Guarnizione Ornamentale Ammortizzatori Posteriori | 0005333003 |

MATCHLESS

| <i>Articolo</i> | <i>Descrizione</i> | <i>Simile al Nr. Orig.</i> |
|-----------------|--|----------------------------|
| 00545 | Paio Copripedali Guidatore Diam.13 Dx + Sx | |
| 00854 | Premistoppa Aste Valvole Inf. | |
| 00855 | Premistoppa Aste Valvole Sup. 28x18x15 | |
| 00855/S | Premistoppa Aste Valvole Superiore | |

MINARELLI

| <i>Articolo</i> | <i>Descrizione</i> | <i>Simile al Nr. Orig.</i> |
|-----------------------|--|----------------------------|
| 01567 | Coprileva Avviamento Foro Cieco Diam.12 | 2401580000 |
| 06954 | Manicotto Carburatore Diam.36 | 242020 |
| 08911 | Manicotto Carburatore Diam. 28 | |
| 10937 | Manicotto Carburatore Motore Orizzontale Scooter | |
| 10940 | Gommino Cablaggi Booster | |
| 10969 | Manicotto Carburatore Motore Orizzontale Cy50 | 4CUE3550000 |
| Articoli Non Figurati | | |
| P/346 | Paraolio Htcyl 38 X 20 X 7 Booster | |



| <i>Articolo</i> | <i>Descrizione</i> | <i>Simile al Nr. Orig.</i> |
|-----------------|--|----------------------------|
| 00575 | Copripedale Guidatore Foro Diam.14 | |
| 00575/A | Copripedale Mi-Val Foro Diam.14 | |
| 01515 | Coprileva Cambio | |
| 01516 | Coprileva Avviamento | |
| 01841 | Parastrappi Trapezoidale Per Ciclomotore | |
| 02864 | Paraolio Forcella | |
| 02996 | Passacavo Fanalino Posteriore | |
| 03937 | Protezione Uscita Cavo Candela 48 Cc | |
| 03965 | Guarnizione Foderi Forcella 34 X 36 | |

MONDIAL

| <i>Articolo</i> | <i>Descrizione</i> | <i>Simile al Nr. Orig.</i> |
|-----------------|---|----------------------------|
| 00544 | Paio Copripedali Guidatore Dx + Sx 125 Cc. | |
| 00544/A | Paio Copripedali Guidatore Dx + Sx 160-200 Cc. | |
| 00553 | Coprileva Selettore Cambio 200 Cc. Foro Diam.8 Lungh.48 | |
| 00596 | Coprileva Selettore Cambio 160 Cc. - Sogno | |
| 00657/57/A | Paio Manopole Diam.22-24 | |
| 02863 | Guarniz. Asta Frizione 125-175 Sport-Turismo | |
| 03906 | Boccola Forcella Marzocchi 30 Mm Per Mondial | 51712182 |

MORINI

| <i>Articolo</i> | <i>Descrizione</i> | <i>Simile al Nr. Orig.</i> |
|-----------------|---|----------------------------|
| 00521 | Copripedale Guidatore In Pvc | 30.01.22. |
| 00521/A | Copripedale Guidatore In Gomma | 30.01.22 |
| 00528 | Coprileva Selettore Cambio | |
| 00631/32 | Paio Manopole Morini | |
| 00832 | Parastrappi 175 Cc. | |
| 00832/A | Parastrappi 175 Cc. 2^ Serie | |
| 00912/A | Soffietto Sospensione Post. 125 Cc. Diam. 50 Mm. 11 Spire | |
| 00912/B | Soffietto Sospensione Anteriore 9 Spire | |



★ 00575/A



★ 00575



★ 01516



★ 01515



★ 01841



★ 02864



★ 02996



★ 03937



★ 03965

MONDIAL



★ 00544/A



★ 00544



★ 00657/57/A



★ 00596



★ 00553



★ 02863



★ 03906

MORINI



★ 00521/A



★ 00521



★ 00631/32



★ 00528



★ 00832/A



★ 00832



★ 00912/A



★ 00912/B

| <i>Articolo</i> | <i>Descrizione</i> | <i>Simile al Nr. Orig.</i> |
|-----------------|--|----------------------------|
| 00912 | Soffietto Sospens. Post. 125 Cc. Diam. 60 Mm. 8 Spire | |
| 00993 | Tampone Arresto Cavalletto 125 Cc. | |
| 01511 | Coprileva Selettore Cambio 175 Cc. | |
| 01543/A | Copripedale Guidatore diam. 14 Mm - Lungh. 104 Mm | |
| 01558 | Coprileva Avviamento 175 Cc. Foro Diam.14 Mm. Lungh.70 Mm. | |
| 01569 | Coprileva Avviamento Diam.14 - Corsarino | |
| 01578/B | Copripedale Guidatore | |
| 01805 | Parastrappi Ruota Posteriore Sbarazzino 98 Cc. | |
| 01816 | Parastrappi Tresette Sprint | |
| 01821 | Parastrappi Corsaro - 2 Pezzi - | |
| 01838 | Parastrappi Mozzi Grimeca Diam.83 | |
| 02851 | Guarnizione Paraolio Perno Avviamento Diam. 14 X 2 Mm. | |
| 02874 | Coperchio Di Tenuta Per Presa Diretta | |
| 02889 | Anello Tenuta Condotti Lubrificazione T-Gt-Super Sport | |
| 02960 | Anello Paraolio Forcella (= Or 00365) | |
| 03894 | Anello Di Tenuta Nel Castelletto Distribuzione 175 Cc. | |
| 03895 | Anello Di Tenuta Lubrificazione Albero Distribuzione 175 Cc. | |
| 03896 | Guarnizione Passaggio Olio Pompa A Distribuzione 175 Cc. | |
| 03964 | Guarnizione Di Fine Canotto Forcella Diam. 34 Mm. | |
| 04930 | Tampone Arresto Leva Avviamento Corsaro | |
| 05858 | Guarnizione Passaggio Olio Cilindro 175cc.Gt (11,4x5x2) | |
| 10944 | Calotta Verlicchi Per Corsarino | |

MOSQUITO

| <i>Articolo</i> | <i>Descrizione</i> | <i>Simile al Nr. Orig.</i> |
|-----------------|---|----------------------------|
| 00646 | Paio Manopole Bmg 48 Cc. | |
| 00870 | Guarniz. Per Tappo Serbatoio Benzina Mosquito Diam. 24x33x3 | |
| 00872 | Guarnizione Carter Diam. 14 X 9 | |
| 00872/A | Guarnizione Motore 38 Diam. 14 X 9 | |
| 00873 | Guarnizione Carter Diam. 28 X 20 | |
| 00875 | Guarnizione Per Sospensione Diam. 16 X 10 | |
| 01543 | Copripedale Guidatore Foro Diam.12 | |
| 02860 | Guarnizione Per Volano 38/B | |
| 02885 | Guarnizione Con Molla Per Volano 3B 2a Serie | |
| 02894 | Guarnizione Lato Ruttore 38/B | |
| 03920 | Tampone Fine Corsa Ritorno Leva Avviamento | |



★ 00912



01543/A



★ 01558



★ 01578/B



★ 01805



★ 01816



★ 01821



★ 02874



★ 03895



★ 03964



★ 00993



★ 04930



★ 03896



★ 02889



★ 02851



★ 02960



★ 03894



★ 05858



★ 01838



★ 10994



★ 01511



01569

MOSQUITO



★ 00646



★ 01543



★ 02885



★ 00870



★ 00872/A



★ 00872



★ 00873



★ 00875



★ 02860



★ 02894



★ 03920

| <i>Articolo</i> | <i>Descrizione</i> | <i>Simile al Nr. Orig.</i> |
|-----------------|--|----------------------------|
| 00846 | Parastrappi Ruota Posteriore Diam. 24x10x7 Mm. | |
| 00847 | Parastrappi Ruota Posteriore Diam. 20,5x11,5x7 Mm. | |
| 01513 | Copripedale Guidatore Imperiale 125 Cc. Foro Baionetta | 3219 |
| 01536 | Coprileva Cambio | |
| 01547/A | Coprileva Leva Messa In Moto - Foro Diam. 13 Mm. - 125 Sprite /250 Barracuda | M149 |
| 03943 | Paracolpi Ritorno Cavalletto Imperiale 125 Cc. | 3149 |
| 03944 | Gommino Fissaggio Serbatoio Imperiale | 3182 |
| 03997 | Anello Passacavo Volano Magnete | |
| 05866 | Guarnizione Sulla Mandata Pompa Olio Imperiale 125 Cc. | 3021 |
| 06885 | Anello Tenuta Olio Asta Comando Frizione Imperiale 125 4t. | |
| 06887 | Passacavo Custodia Pignone Catena 125 Cc. | |
| 06888 | Anello Di Tenuta Mandata Olio 125 Cc. | 3011 |
| 06889 | Paraolio Imperiale 125 4t. | |
| 06890 | Anello Di Tenuta Olio Su Albero Preselettore Cambio 125 Cc. | |

MOTOM

| <i>Articolo</i> | <i>Descrizione</i> | <i>Simile al Nr. Orig.</i> |
|-----------------|--|----------------------------|
| 00531 | Coprileva Avviamento Mod.51 Foro Diam.9 Lungh.65 | |
| 00638 | Paio Manopole Diam.24 Prima Serie | |
| 00638/A | Paio Manopole Diam. 24 | 25546 |
| 00841 | Parastrappi Ruota Posteriore Delfino 160 Cc. | |
| 01501 | Gomma Pedali Prima Serie | |
| 01537 | Copripedale Guidatore 98 Cc. Foro Diam. 17 Mm. | |
| 01537/A | Copripedale Guidatore 98 Cc. 1959 Foro Diam. 13 Mm. | |
| 01811 | Parastrappi Ruota Motom Pegaso 48 Cc Sport | |
| 01822 | Parastrappi Mod.51 - Diam.20x7x9,5 | |
| 01853 | Guarnizione Motore 48 Cc. Lato Comando Frizione | |
| 01853/A | Guarnizione Motore 48/C-51 | |
| 01854 | Guarnizione Motore Pegaso 48 Cc. | |
| 01855 | (E)Guarnizione Motore 48 Cc. Lato Trasmissione | |
| 01855/A | Guarnizione Motore Lato Trasmissione 48/C-51 | |
| 01856 | Guarnizione Paraolio Motore 48 Cc. Sul Coperchio Laterale | |
| 01987/A | Anello Supporto Motore | |
| 02945 | Paracolpo Forcella Anteriore 48 Cc. | |
| 02997 | Guarnizione Tappo Serbatoio Benzina 48 Cc. | |
| 03922 | Guarnizione Flangia Attacco Carburatore | |
| 03924 | Soffietto Forcella Diam. 21/30 8 Spire Lungh.120 | |
| 03926 | Tampone Elastico Per Forcella Posteriore | |
| 04898 | Anello Di Guarnizione Per Sede Punterie L-L1/51 | |
| 05898 | Anello Di Tenuta Sede Punterie Modello 51 Diam. 11,4 X 2,8 | |



☆ 01547/A

☆ 01513

☆ 01536

☆ 03943

☆ 03997

☆ 03944



☆ 00846

☆ 00847

☆ 05866

☆ 06885

☆ 06887

☆ 06888

☆ 06889

☆ 06890



☆ 00638/A

☆ 00638

☆ 00531

☆ 01501



☆ 01856

☆ 01537/A

☆ 01537

☆ 03924



☆ 04898

☆ 05898

☆ 01853/A

☆ 01853

☆ 01854

☆ 01855/A

☆ 01855

☆ 00841



☆ 01811

☆ 01822

☆ 03926

☆ 01987/A

☆ 02945

☆ 02997

☆ 03922

| <i>Articolo</i> | <i>Descrizione</i> | <i>Simile al Nr. Orig.</i> |
|-----------------|--|----------------------------|
| 00522 | Coprileva Freccia D'oro 3 Marce - Foro 14 - | |
| 00538/A | Copripedale Guidatore Checca 98 Cc.- 350 Cc.Sport 1971 | |
| 00542 | Copripedale Guidatore 125 Cc. 3 Marce 2 Tempi | |
| 00542/A | Paio Copripedali Guidatore Dx + Sx - 125-150-175 Cc. | |
| 00576 | Coprileva Freno | |
| 00577 | Coprileva Selettore Cambio | |
| 00639/40 | Paio Manopole Diam. 22-24, Grigie | |
| 00639/40-N | Paio Manopole Diam. 22-24, Nere | |
| 00639/40-R | Paio Manopole Diam. 22-24 Rosso | |
| 00818 | Parastrappi Ruota Scooter Cgt - Csl | |
| 00821 | Parastrappi Ruota 20 X 9 X 6 Mm - 83 Cc | |
| 00824 | Parastrappi Ruota Ovunque Diam. 22 X 11,5 X 6 | |
| 00836 | Parastrappi Frizione 175 Cc. Diam. 22 X 13 X 5 | |
| 00895 | Guarnizioni Paraolio Albero Cambio Diam. 25x14x4,5 | |
| 00895/A | Guarnizione Stelo Valvola Cambio | |
| 00896 | Guarnizione Paraolio Albero Motore Diam. 28x16x4,5 Mm. | |
| 00896/A | Guarnizione Paraolio Albero Motore 350 Cc. | |
| 00897 | Guarnizione Paraolio Albero M/Moto Diam. 26x18x4,5 Mm. | |
| 00994 | Guarnizione Tappo Serbatoio Benzina Diam. 47x37x3 | |
| 00996 | Soffietto Molleggio Anteriore | |
| 01545 | Paio Copripedali Guidatore 83 Cc. E Liberty - Dx E Sx | |
| 01617/A | Paio Manopole Comandi Tommaselli Daytona - Nero | |
| 01617/A-P | Paio Manopole Comandi Tommaselli Daytona - Para | |
| 01617/A-R | Paio Manopole Comandi Tommaselli Daytona - Rosso | |
| 01801 | Parastrappi 175 Cc. Csta Tipo America - Centomila 29x10x7 | |
| 01802 | Parastrappi 175 Cc. Cs Sport - Cgst - 250 Cc. Raid | |
| 01895 | Guarnizione Per Prigionieri Testa Mm. 9 X 2,5 | |
| 01896 | Guarnizione Paraolio Albero Motore Diam. 24x34x4 Mm. | |
| 01926 | Passacavo Carter | |
| 01927 | Premistoppa Sull' Albero Comando Frizione | |
| 01959 | Soffietto Mv Pullmann | |
| 02869 | Guarniz.Sez.Rettang.Tenuta Coperto Filtro Diam.64x60x2 | |
| 02872 | Boccola Attacco Ammortizzatore 175 Cc. Diam. 34 X 16 | |
| 02887 | Guarnizione Di Tenuta Stelo Valvola 175 Cc. Cs 1957 | |
| 02998 | Cuffia Portastrumenti Mv 350 Cc Ipotesi - Sport - Gt | |
| 04892 | Guarnizione Asta Frizione 83 Cc. Rapido 125 Cc. 4 T. | |
| 05948 | Elastico per Serbatoio - Lungh.170 mm. | 21321055000 |
| 05961 | Boccola Ancoraggio Serbatoio | |
| 05965 | Guarniz. Attacco Carburatore 250-350-350 Sport - Scrambler | |
| 05999 | Raccordo Isolante Carburatore 750 - 750 Gt. | |
| 06884 | Raccordo Isolante Carburatore 750 - 750 Gt. | |

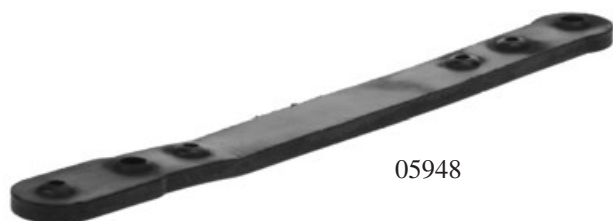

05948



★ 00522



★ 00538/A



02998



★ 00542



★ 00542/A



★ 00639/40
00639/40-N
00639/40-R



★ 01545



★ 00818



★ 00821



★ 00824



★ 00836



★ 00895/A



★ 00895



★ 02887



★ 01896



★ 00576



★ 00577



★ 02872



★ 01802



★ 05961



★ 02869



★ 00994



★ 06884
05999



★ 05965



★ 01801



★ 00896/A



★ 00896



★ 00897



★ 01926



★ 04892



★ 01927



★ 01895



★ 00996



★ 01959



★ 01617/A
01617/A-P
01617/A-R

| <i>Articolo</i> | <i>Descrizione</i> | <i>Simile al Nr. Orig.</i> |
|-----------------|---|----------------------------|
| 01609/M | Paio Manopole 22-26 - Etz 125-150 251-301 | |
| 02536 | Coprileva Cambio Etz 125/150 251/301 | 06-47.050 |
| 02537 | Coprileva Avviamento Etz 125/150 251/301 | 05-46096 |
| 09985 | Paio Soffietti Forcella Mz Tutti I Modelli | 22-22.289 |
| 10910 | Tampone Centrale Motore - Etz 125/150 251/301 | 22-20.032 |
| 10911 | Tampone Serbatoio Etz 125/150 251/301 | 30-27.040 |
| 10912 | Tamponcino Etz 125/150 251/301 | 16-31.023 |
| 10913 | Cappuccio Etz 125/150 251/301 | 30-34.714 |

NSU

| <i>Articolo</i> | <i>Descrizione</i> | <i>Simile al Nr. Orig.</i> |
|-----------------|-----------------------|----------------------------|
| 03927 | Manicotto Aspirazione | |

PARILLA

| <i>Articolo</i> | <i>Descrizione</i> | <i>Simile al Nr. Orig.</i> |
|-----------------|---|----------------------------|
| 00411/12 | Paio Ginocchiere Dx E Sx | |
| 00543 | Paio Copripedali Guidatore Sx+Dx | |
| 00543/B | Paio Copripedali Guidatore Foro Diam.13 Sx+Dx | |
| 00622 | Paio Manopole Con Marchio Parilla Diam. 24-24 | |
| 00622/22/A | Paio Manopole Con Marchio Parilla Diam. 22-24 | |



☆ 02536



☆ 02537



☆ 10910



☆ 10911



☆ 10913



☆ 10912



☆ 09985



☆ 01609/M

NSU



☆ 03927

PARILLA



☆ 00411/12



☆ 00622



☆ 00543/B



☆ 00543



☆ 00622/22/A

PARILLA

| <i>Articolo</i> | <i>Descrizione</i> | <i>Simile al Nr. Orig.</i> |
|-----------------|---|----------------------------|
| 00528/A | Coprileva Cambio Parilla Diam. Int. 9 Mm. - 175 Cc. | |
| 00543/A | Copripedale Guidatore Con Marchio Parilla | 174443 |
| 01509 | Coprileva Avviamento | |
| 01852 | Guarnizione Tappo Serbatoio Benzina | |
| 02913 | Paraolio Aste Valvole 175 Cc. | 174862 |

PUCH

| <i>Articolo</i> | <i>Descrizione</i> | <i>Simile al Nr. Orig.</i> |
|-----------------|--|----------------------------|
| 00697 | Paio Manopole Ciclomotore Comandi Magura | |
| 01596 | Coprileva Avviamento Lungh.61 Foro Passante Diam.10 | |
| 01597 | Coprileva Cambio | |
| 01602 | Paio Manopole 22-24 Comando Magura | |
| 02503 | Coprileva Freno | |
| 02504 | Copripedale Guidatore Puch Foro Ovale Cieco 15 X 8 L.108 | |
| 04999 | Cappuccio Candela In Silicone | |
| 06902 | Tendicavo Comando Gas Magura | |
| 06909 | Cappuccio Raccordo Carburatore Scatola Filtro | 050.10.1577 |
| 06912 | Raccordo Carburatore Filtro | 362.10.245 |
| 06914 | Soffietino Copricavi Comando Magura | |
| 06931 | Tappo | |
| 06932 | Arresto Messa In Moto | |

RUMI

| <i>Articolo</i> | <i>Descrizione</i> | <i>Simile al Nr. Orig.</i> |
|-----------------|-------------------------------|----------------------------|
| 00562 | Copripedale Guidatore Foro 14 | |



☆ 00543/A



☆ 02913



☆ 01852



☆ 01509



☆ 00528/A

PUCH



01596



01597



☆ 02503



☆ 06931



☆ 06932



☆ 06909



02504



☆ 01602



☆ 06912



☆ 06902



☆ 00697



04999



06914

RUMI



☆ 00562

| <i>Articolo</i> | <i>Descrizione</i> | <i>Simile al Nr. Orig.</i> |
|-----------------|---|----------------------------|
| 00508/B | Copripedale Guidatore Diam.14 | 2160 |
| 00619/20 | Paio Manopole Sertum Diam.23/25 Nere - 250 Cc. VT | |
| 00619/20GR | Paio Manopole Sertum Diam.23/25 Grigie | |

STERZI

| <i>Articolo</i> | <i>Descrizione</i> | <i>Simile al Nr. Orig.</i> |
|-----------------|---|----------------------------|
| 00532 | Coprileva Selettore | |
| 00533 | Coprileva Guidatore Foro Cieco Diam. 14 | |
| 00534 | Coprileva Passeggero Foro Piatto | |

SUZUKI

| <i>Articolo</i> | <i>Descrizione</i> | <i>Simile al Nr. Orig.</i> |
|-----------------|---|----------------------------|
| 01583 | Coprileva Cambio Lungh.46 Foro Cieco Diam.8 | |
| 01586 | Coprileva Avviamento Lungh.73 Foro Passante Diam.11 | |
| 01588 | Coprileva Avviamento Lungh.58 Foro Passante Diam.9 | |
| 01680/SSF | Paio Manopole Fino Al 2007 | |
| 02623/SSF | Paio Manopole Dal 2007 | |
| 08971 | Paio Calotte Forcella Diam.38 Rm 125-250 | |
| 08971/A | Paio Calotte Forcella Diam.43 Rm 250-465 | |
| 08989 | Pattino Protezione Forcellone Serie Er | |
| 09920 | Paio Calotte Forcella Nere Diam.43 | |



☆ 00508/B



☆ 00619/20



☆ 00619/20GR

STERZI



☆ 00532



☆ 00533



☆ 00534

SUZUKI



01583



01586



01588



☆ 08989



02623/SSF



01680/SSF



☆ 08971
08971/A



☆ 09920

| <i>Articolo</i> | <i>Descrizione</i> | <i>Simile al Nr. Orig.</i> |
|-----------------|--|----------------------------|
| 00547 | Coprileva Avviamento 125 V30t>V33t - Vm1/2t - Vn1t -150v11/2/3t-Vb1t- 150gs Vs1/2/3/4/5 | 013973 |
| 00547/A | Coprileva Avviamento Px (Tutte) - 150 Vbb | 241004-49642 |
| 00548 | Copripedale Avviamento Mod.50 - 125cc. 1957 - | |
| 00550 | Coprileva Freno 98 Cc - 125 1948>1950 V1>V15t | 002804 |
| 00551 | Coprileva Leva Freno Mod. 125 V30t>V33t -Vm1/2t - Vn1t -150v11/2/3t-Vb1t- 150gs Vs1/2/3/4/5 | 013647 |
| 00551/A | Coprileva Freno 125 Vnb3/4/5/6t - Vnc - Vn12 Fino Al Telaio 30001 - 150 Vbb1/2t Vbc -150gl Vba - 150 Gs Vs5 - 160gs Vsb1 - 180ss Vsc - 180 Rally Vsd - 200 Rally Se | 093100 |
| 00551/B | Coprileva Freno 50 V5ss - V5a1t Dal Telaio 92877 - 90 V9ss - 125 Vma1/2t - Vmb1 | 100426 |
| 00551/C | Coprileva Freno 50 - Px Pe - Pk - Colore Nero | 162001-182051 |
| 00551/D | Coprileva Freno Dal '94 Pk-Px | 266299 |
| 00578 | Coprileva Avviamento 50 - 90 - 125 Primavera - Et3 - Colore Nero | |
| 00590/A/15 | Copripedale Passeggero Foro 15 | |
| 00590/A/17 | Copripedale Passeggero Foro 17 | |
| 00615-GR | Paio Manopole Grigie Diam.24 125 Cambio Bacc.1948-1950 Dal V1t Al V15t - 1951-1952 Dal V30 Al V33t -1953-1954 Dal Vm1 Al V2t -Utilitaria 1952-1957 Vn1 Al V2t | 012153 |
| 00615/B-GR | Paio Manopole Grigie Mod. '50 - '55 | |
| 00615/C | Paio Manopole Nere Diam.24 - 150/'56 V1rt - 50 V5a1t - V5ss1t - 90 V9a1t - V9ss1t 125 Vma1t - Vna1/2t - Vnb12t Primavera -> '78 - | 70577-028151 |
| 00615/C-GR | Paio Manopole Grigie Diam. 24 - 150/'56 V1rt - 50 V5a1t - V5ss1t - 90 V9a1t - V9ss1t 125 Vma1t - Vna1/2t - Vnb12t Primavera -> '78 - | 70577-028151 |
| 00615/D | Paio Manopole Nere Diam.21 Dal 1957 Al 1966 - 125 Vnb3/4/5/6t 150 Vb1t -Vba1t -Vbb1t -150 Gl Vla1t - 160 Gs Vsb1t - 180 Ss Vsb1t | 141925-060304 |
| 00615/D-GR | Paio Manopole Grigie Diam.21 Dal 1957 Al 1966 - 125 Vnb3/4/5/6t 150 Vb1t -Vba1t -Vbb1t -150 Gl Vla1t - 160 Gs Vsb1t - 180 Ss Vsb1t | 141925-060304 |
| 00686 | Paio Manopole Ciao | 122184 - 122185 |
| 00687 | Paio Manopole Nere Sprint-Sprint Veloce- 200 Rally | 127556 |
| 00687/A | Paio Manopole Nere 50-90-125 Primavera - 125 Et3 Dal 1978 - 50 V5a2/3t V5b24t - 125 Vma2t -Vmb1 | 141924 |
| 00687/C | Paio Manopole Nere Px - Pe - 125 Vn12t - Vnx1t -150 Vlb1t - Vlx1t 180 Rally Vsd1t - 200 Vse1t - Vsx1t | 141923 |
| 00888 | Guarnizione Biconica Per Sospensione Anteriore | |
| 00889 | Guarnizione Tappo Serbatoio Miscela - Tutti I Modelli Esclosi 50/90/125 Primavera Et3 | 002319 |
| 00902 | Cappuccio Candela | 046741 |
| 00902/A | Cappuccio Candela 50/90/125 Primavera Et3 | 244395 |
| 00911 | Soffietino Asta Cambio a Bacchetta Vespa 125 1949-1950 - Colore Grigio - | 012590 |
| 01533 | Coprileva Freno Mod.125 1953-61 - 125 Vu1t 1953 - Vn1/2t 1954-1957 Vna1/2t 1956-1958 - Vnb1/2t 1959-1961 | 13647 |
| 01619/V | Paio Manopole per Vespa Px80 Vx81t - 200E Lusso Vsx1t 125 T5 VNX5T Dal 1985 | 178159 |
| 01638/V | Paio Manopole Per Vespa Pk 50 XI Nero | |
| 01638/VR | Paio Manopole Per Vespa Pk 50 XI Rush Grigio | |
| 02520 | Coprileva Avviamento Serie Pk Tutti I Modelli | |
| 02531 | Coprileva Freno Vespa Cosa 125/150/200 Cc | 228793 |



★ 00547



00547/A



★ 00551/A



★ 00551



★ 00550



★ 01533



★ 00548



00551/B



00551/C



00551/D



00578



★ 02520



★ 02531



★ 00590/A/15
00590/A/17



★ 01619/V



★ 00615/B-GR



00615/C-GR
00615/D-GR



00615/C
00615/D



★ 00686



00687/A



★ 00687
00687/C



★ 00615-GR



01638/V



01638/VR



★ 00911



★ 00888



00889



00902/A



00902

| <i>Articolo</i> | <i>Descrizione</i> | <i>Simile al Nr. Orig.</i> |
|-----------------|--|----------------------------|
| 00903 | Cappuccio Alta E Bassa Tensione Motore 125/1951-57 -150/58 | 016518 |
| 00945 | Cappuccio Tenuta Fra Diaframma E Raccordo Immissione 1951-54 1 -125 V1t>V15t V30t>33t - Vm1>2t - Vu1t Utilitaria | 011249 |
| 00945/A | Cappuccio Tenuta Per Modello 125/1956-57 E 150/1956-58 125 Vn1t>2t Vespa 150 V11t>3t-Vb1t | 022674 |
| 00948 | Protezione Guaine Vespa 150 1956 | 015423 |
| 00950 | PASSACAVO NERO PER COMMUTATORE | 015098 |
| 00950-GR | Passacavo Grigio Per Commutatore | 015098 |
| 00952 | Tampone Per Ammortizzatore Mod. 1951-54 -125 V1t>V15t - V30t>33t - Vm1>2t - Vu1t Utilitaria | 006359 |
| 00953 | Tampone Superiore Per Ammortizzatore Mod. 1951-54 -125 V1t>V15t V30t>33t - Vm1>2t - Vu1t Utilitaria (Foro Laterale Piccolo) | |
| 00979 | Cappuccio Prot. Grigio Guaine Al Manubrio Largh. 28 Mm. 125 V30t>V33t - Vm1/2t -Vu1t -Vn1/2t - 150 V11/2/3t -150 Gs Vs1t | 015366 |
| 00979/C | Cappuccio Protezione Guaina Manubrio Grigio | |
| 00980 | Selletta Ammortizzatore Per Manubrio Modello 1954-55 | 015212 |
| 00982 | Guarnizione Per Fanalino Post. Mod. 1951/53 | |
| 00986 | Tampone Battuta Cavalletto | |
| 00987 | Passacavo Sulla Scocca - 1°Serie 1950 - 125 -150 1948>58 Per Modelli Cambio A Bacchetta 98-125 1948 Al Commutatore Luci E Telaio | 010217 |
| 00989 | Tampone Di Scontro Traversa Motore 125 Cc. - Mod.1951 125 V1t>V15t V30t>V33t - 125 Vm1/2t-Vn1/2t -150 V11/2/3t-Vb1t-150 Gs Vs1/2/3/4/5t | 014836 |
| 01657 | Paio Manopole Nere Grillo | 229741/229745 |
| 01658/V | Paio Manopole Grigie Pk 50 - 125/F12 1990 | 266187 |
| 01659/V | Paio Manopole Cosa 125-150-200 Lx | 228541 |
| 01660 | Paio Manopole Grigie Sfera 50 Cc. | 267205/267206 |
| 01677 | (E)Paio Manopole Vespa Hp-V 50 Cc | 274489-274489 |
| 01873 | Anellino Fra Cambio E Messa In Moto Diam. 13x10x3,4 Mm. | |
| 01898/A | Paraolio 40 X 20 X 6 Con Flangia Mm.60 Tacca Tonda | 3/25180 |
| 01898/B | Paraolio 40 X 20 X 6 Con Flangia Mm.60 Tacca Quadra | 2/84644 |
| 05899 | Tegolino Paraolio 125 Cc. 1958-59-60 | 46803 |
| 06882 | Guarnizione Depuratore 125cc.Mod.1960/61-150cc.Mod.1959/60 | 58364 |
| 07851 | Guarniz. Ammortizz. Anteriore 125/1960-62-150/1961-62-Gs-60 | |
| 07852 | Guarnizione Ammort. Posteriore 125/1960-62 E 150/1961-62 | |
| 07872 | Serie Paraolio Carburatore 150 Cc. 2% | |



★ 01657



01658/V



01659/V



★ 01660



01677



07872



01898/A



01898/B



★ 05899



★ 06882



★ 01873



★ 07851



★ 07852



★ 00945/A



★ 00945



★ 00979/C



★ 00979



★ 00982



★ 00980



★ 00950-GR



★ 00950



★ 00986



★ 00987



★ 00948



★ 00989



★ 00952



★ 00953



★ 00903

| <i>Articolo</i> | <i>Descrizione</i> | <i>Simile al Nr. Orig.</i> |
|-----------------|---|----------------------------|
| 00915 | Soffietto Aspirazione 150 Gl -Px 125 - Px 150 Vlx1 - Vnx1 - Vsx1 -Pe - Vnx5 | 181476 |
| 00941 | Paio Piedini Cavalletto 125 I Serie - V30t/V33t (1950-1952) | |
| 00941/A | Paio Piedini Cavalletto 125 Ii Serie - Vm1t/Vm2t (1953-1954) | |
| 00941/B | Paio Piedini Cavalletto 125 Vn1/2t - 125u Vu1t Utilitaria 1953 | |
| 00941/C | Paio Piedini Cavalletto 125 '58/60 - 150 Gs Ii Serie - Vs2t/Vs3t/Vs4t (1956-1958) 150 Gs Iii Serie - Vs5t (1958-1961) | 84227/84228 |
| 00941/D | Paio Piedini Cavalletto 125 - 150 1961-63 - Foro Mm 18 | 54146-54147 |
| 00941/E | Paio Piedini Cavalletto 50-90-125 Primavera >1971 - | 101971/101972 |
| 00941/F | Paio Piedini Cavalletto 50-90-125 Primavera - 125 ET3 Dal 1972 | 135387/135388 |
| 00941/G | Paio Piedini Cavalletto Serie Px-Pe Fino Al 1979 | 174919 |
| 00941/H | Paio Piedini Cavalletto Px - Pe Dal 1980 - Serie Pk | 176166 |
| 00944 | Guarnizione Portafaro Vespa 125 Cambio a Bacchetta V15T 1951-'52 - V30T>V33T | 14229 |
| 00944/A | Guarnizione Portafaro Vespa 125 1953>1957 VM1>2T - VN1>2T | 018855 |
| 00945/B | Cappuccio Depuratore 50-90-125 Primavera - Et3 | 71813 |
| 00948/B | Manicotto Protezione Guaine al Telaio e Commutatore Luci 125 1951-57 V30>33T - VM1>2T - U - VN1>2T - Vespa 150 1954-58 VL1>3T - GS VS1 | 018937 |
| 00948/C | Manicotto Protezione Guaine Al Telaio | |
| 00949 | Manicotto Protezione Asta Comando Rubinetto Benzina 1954-1955 - 125 V30t>33t-Vm1t>2t - Vespa 150 V11t>3t- Vb1t-Vs1t>5t | |
| 00951 | Tacchetto Di Scontro Sportello Ispezione Carburatore | 011760 |
| 00977 | Cappuccio Per Asta Rubinetto Benzina Modello 1954-55 | |
| 00978 | Cappuccio Per Dado Ad Alette Tappo Serbatoio Benzina 1954-1955 125 V30t>33t-Vm1t>2t - Vespa 150 V11t>3t- Vb1t-Vs1t>5t | |
| 02952 | Cappuccio A Cono Per Intermittenza | |
| 02953 | Manicotto Astina Serbatoio | |
| 02955 | Cappuccio Alta E Bassa Tensione 150 Cc. 1955-58 - V11t>3t - Vb1t - Gs Vs1t>5t | 022694 |
| 02955/A | Cappuccio Presa Alta Tensione 150 Cc. 1959-61 - 150 GL 1963/64 - 180 Rally | 48525 |
| 02956 | Ammortizzatore Inferiore Diam 32 X 14 X 16 | 057012 |
| 02957 | Silentblock Ammortizz. Anteriore Parte Super.Diam.24x14x10 | |
| 02958 | Tampone Gomma Sulla Sella Mod. Gs 1955-61- V11t>3t - Vb1t - Gs Vs1t>5t | 024722 |
| 02959 | Tampone Traversa Motore Mod. 125/1955-57 125 Vn2t - 150 V11t>3t Vb1t - Vgl1t E 15ogs/1955-58 Vs1>5t | 040840 |
| 02961 | Boccola Supporto Braccio Motore Mod. 1953-54 | |



02955/A



☆ 00941/A

☆ 00941/B

☆ 00941/C

00941/D



00941/E

00941/F

☆ 00941/G

00941/H



☆ 00941

☆ 00948/B

☆ 00948/C

☆ 00949

☆ 00951

☆ 00977

☆ 00978



☆ 00944/A



☆ 00944



00945/B



00915



☆ 02956



☆ 02957



☆ 02952



☆ 02953



☆ 02955



☆ 02958



☆ 02959



☆ 02961

| <i>Articolo</i> | <i>Descrizione</i> | <i>Simile al Nr. Orig.</i> |
|-----------------|---|----------------------------|
| 00982/A | Guarnizione Fanalino Posteriore 125 Vna2t - 150 1958>60 Vba1t>110485 150 Gs Vs4-5t >0087589 | 021085 |
| 00983 | Boccola Traversa Motore Mod. 1951 | 017100/1 |
| 00983/A | Silentblock Motore 28x14x16 Mod.1953-54 | |
| 00990 | Guarnizione Tra Supporto E Scocca Vespa Cambio A Bacchetta V1>15t 1951>1952 V33t>228595 | 016955 |
| 01900 | Piastrina Chiusura Cofano 125 Vm1/2t - Vn1/2t - 1953>57 - 150 V11/2/3t - Vb1t 1954>58 | 018946 |
| 01962 | Guarnizione Di Base Contachilometri 125 1951>57 V30T>33T - VM1>2T - VN1>2T 150 1954>57 VL1>3T | 015602 |
| 01962/A | Guarnizione Di Base Contachilometri 150 1957>58 Vb1t - 150 Gs 1955>58 Vs1t>4t | 042009 |
| 01963 | Passacavo Diam.11 | |
| 01963-GR | Passacavo Diam. 11 - Grigio | |
| 01964 | Passacavo Diam.8,5 | |
| 01964-GR | Passacavo Diam. 8,5 Grigio | |
| 01986 | Guarnizione Clackson Grigio Spessore 2 Mm - 125 V15t -Vm1/2t V30t>V33t - Vu1t -Vn1/2m -Vna1/2t - Vnb1/2/3/4/5/6t | 03033 |
| 01986/A | Guarnizione Clackson Grigio - Spessore 4 Mm - 125 Vnc1t - 150 Vnl2 Dal 30001 - 150 GI Vla1t - 180 Ss Vsc1t | 70614 |
| 01986/A-N | Guarnizione Clackson Nero - Spessore 4 Mm - 125 Vnc1t - 150 Vnl2 Dal 30001 - 150 GI Vla1t - 180 Ss Vsc1t | 70614 |
| 01986/B | Guarnizione Clackson Nero - 50 V5A1T - V5SS1T - 90 V9A1T - V9SS1T -125 VNB2T DAL 4718 - VNC1T - 150 VBB1T DAL 32070 -VBC1T | 70615 |
| 01986-N | Guarnizione Clackson Nero Spessore 2 Mm - 125 V15t -Vm1/2t - V30t>V33t Vu1t -Vn1/2m -Vna1/2t - Vnb1/2/3/4/5/6t | 003033 |
| 02950 | Guarnizione Tra Supporto E Scocca 125 V33t 228596> Vm1-2t - Vn1-2t 150 V11-2-3t - Vb1t125 Vn1/2t | 040317 |
| 02951 | Cappuccio Bassa Tensione Mod.150 Cc. 1959-61 | |
| 02962 | Boccola Attacco Sup. Ammortizz. Posteriore 125/1955-57 125 Vn2t - 150 V11t>3t Vb1t - Vgl1t E 15ogs/1955-58 Vs1>5t (Foro Laterale Grande) | 040315 |
| 02963 | Boccola Attacco Inferiore Ammortizzatore Posteriore 125 1948>1957 | |
| 02982 | Cappuccio Presa Alta E Bassa Tensione 98 - 125 1948-1950> 87483 - 98 /125 1948-1952 | |
| 03892 | Guarnizione Leva Frizione 125 ('58 - '59) - 150 ('59) | |
| 03909 | Passacavo Al Parafango 150 V11/2/3t -150 Gs Vs1/2/3/4/5 Fino Al 1957 | 023563 |
| 03911 | Guarnizione Fanalino Posteriore 25 Vnb1t>5t - 150 Vba1t 110486> - Vbb1-2t - 160 Gs Vsb1 | 083055 |
| 03966 | Tamponcino Per Manubrio e Staffe Conta/Km GS VS1T | 26601217 |
| 03968 | Supporto Sinistro Traversa Motore 125 VNA>VNB25 Telaio 015717 150 VBA>VB1M Telaio 42404 | 047947 |
| 03969 | Supp. Destro Traversa Motore Mod. 1953-54 Diam. 30x14x21 Mm | |
| 03970 | Tampone Ammortiz. Posteriore 125/1958-62 E 150/1959-62 | |
| 03971 | Supporto Destro Traversa Motore 125-150 1959 | |
| 03973 | Guarniz.Passaggio Cavo Alta Tensione Gs 150 Vs1>Vs5t Fino Al 1962 | 024446 |
| 03976 | Passacavo Passaggio Diam. 17 Tubo Benzina Gs 150 Vs1>Vs5t Fino Al 1962 | |
| 03977 | Cappuccio Presa Bassa Tensione 150 VS1/2/3/4/5 | 026916 |

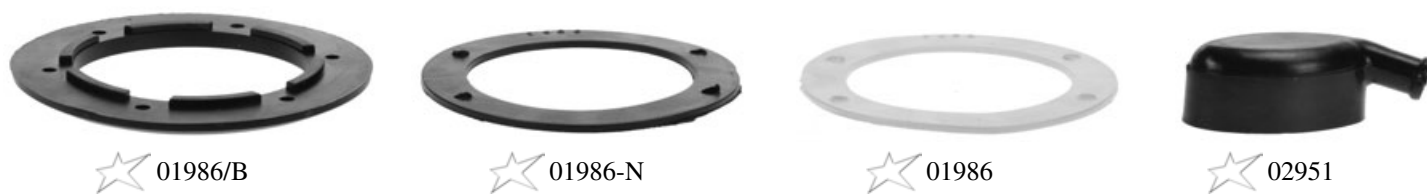
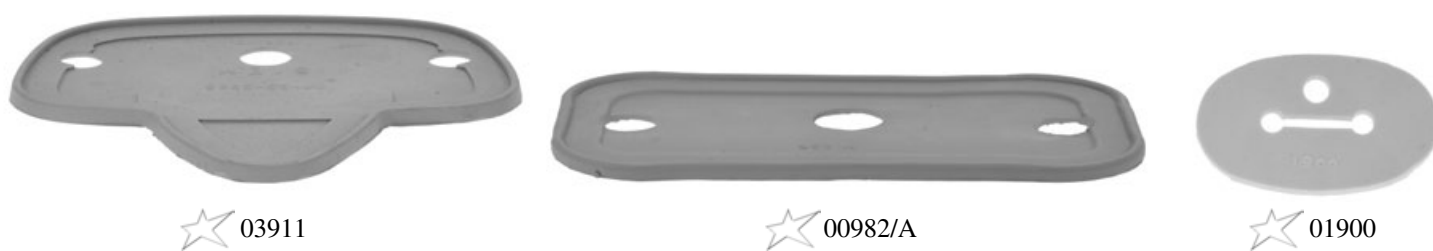

| <i>Articolo</i> | <i>Descrizione</i> | <i>Simile al Nr. Orig.</i> |
|-----------------|--|----------------------------|
| 00995 | Tacchetto Attacco Bauletto 125 A Bacchetta 71500> - V30>V33t - Vm1>2t - U - Vn1>2t Vespa 150 V11>3t -150 Gs Vs1t>5t | 013821 |
| 01901 | Guarnizione Rubinetto Benzina 125 1951>Tutti I Modelli Vespa 50-90-150-160-180-200 (Escluso Gs 150 Vs1t 009451>) | 013836-610219M |
| 01965 | Soffietto Aspirazione Gs 150 Vs1/2/3/4/5t '55-61 | 24152 |
| 03912 | Soffietto Carburatore Foro Piccolo 125 Vna1/2 - Vnb1 - 150 Vba1t Dal Telaio 97499 | 48345 |
| 04953 | Serie Completa Listelli Pedane 50 V5a1t - 90 V9ss1t Fino Al 1970 | 47243-97237 |
| 05910 | Tassello Per Feritoia Volano 50 Cc. Tutti I Modelli | 110162 |
| 05911 | Tassello Per Feritoia Volano 90-125 - Primavera - ET3 - PX | 110586 |
| 05917 | Tampone Sportello 50-90-125 Primavera-Et3 | 98669 |
| 05918 | Tampone Sportello 50-90-125 Primavera-Et3 | 101783 |
| 05920 | Tampone Sportello 50-90-125 Primavera-Et3 | 150566 |
| 05967 | Paraspruzzi Parafango Anteriore Ciao | 142779 |
| 06919 | Tampone Forcella Anteriore Ciao | 103699 |
| 06919/A | Tampone Forcella Px-Pe | 176373 |
| 06957 | Tassello Volano Magnete Ciao-Boxer-Bravo Fino Al 1975 | 102931 |
| 06957/A | Tassello Volano Magnete Ciao-Boxer-Bravo-Si Dal 1976 | 166504 |
| 07904 | Tampone Scontro Cavalletto Px-Pe | 174773 |
| 07908 | Protezione Parafango Anteriore Ciao | 143705 |
| 08970 | Boccola Bobina Alta Tensione Ciao-Boxer-Bravo-Porter-Si | 114164 |
| 08978 | Cappuccio Protezione Cavo Candela Per Tutti Veicoli Piaggio | 071671 |
| 08979 | Cappuccio Isolante Bobina | 073943 |
| 08980 | Cappuccio Bassa Tensione | 161125 |
| 08993 | Tappino Sportello Pk | 215339 |
| 08996 | Paraspruzzi Posteriore Nero Pk | 216989 |
| 09931 | Cuffia Aspirazione Pk | 178694 |
| 09979 | Tampone Ammortizzatore Anteriore Pk | 215499 |
| 09983 | Tamponcino Sportello Pk 50-125 '90/91 | 232222 |
| 09997 | Tampone Settore M/M Pk 50x1 - Pk 125x1 | 240753 |
| 10776 | Paraolio Motore Lato Volano - Vedi Art. P/251 - Mm.62x20x6,5 160 Gs Vsb1t 1962>1964 180 Ss Vsc1t 1964>1968 | 078002 |
| 10851 | Guarnizione Tappo Ciao | 121234 |



★ 01965



★ 08996



09931



★ 05967



10776



06957/A



★ 06957



05910
05911



09979



★ 10851



★ 00995



★ 07908



06919/A



06919



07904



08979



08980



08978



01901



08970



08993



09983



05918



09997



05917



05920



03912



04953

| <i>Articolo</i> | <i>Descrizione</i> | <i>Simile al Nr. Orig.</i> |
|-----------------|--|----------------------------|
| 03972 | Tampone Carter Motore Vespa 125 (Escluso Primavera - Et3)- 150 - 160 - 180 - 200 - Px - Pe | 46742 |
| 03974 | Guarnizione Asta Rubinetto Benzina 125 Vna1/2 - Vnb1/2/3/4/5/6t - Vnc1t - Vnl2t Dal 300001 - 150 Vba1 - Vbb1/2t - Vbc1t - 150 Gl Vla1t - Vlb1t - 160 Gs Vsb1t 180 Ss Vsc1t - 180 Rally Vsd1t - 200 Rally Vse1t | 47460/132538 |
| 03974-B | Guarnizione Asta Rubinetto Benzina Come 03974 ma in Colore Grigio | |
| 03974/A | Passacavo Asta Rubinetto Benzina Px-Pe Dal 1983 Px Vnx2t 53220> - Vlx1t 430975> Vsx1t 138247> - Vbx1t 187801> - V8x1t 37552> - Vnx5t | 194631 |
| 03978 | Passacavo A Pipa Starter Acceleratore 125-150 1958> - 160 - 180-200 Rally - Px - Pe | 48171 |
| 03979 | Passacavo Volano Magnete 50-90-125 Primavera - ET3 - 125 VNA1>2T - VNB1>5T | 46766 |
| 04902 | Passacavo Cofano Vespa 125/150 Dal 58 Al 61 E Px 1978/1986 | |
| 04902-GR | Passacavo Grigio Cofano Vespa 125/150 Dal 58 Al 61 E Px 1978/1986 | |
| 04903 | Tampone Appoggio Batteria 125/1960-62 E 150/1956-62 | |
| 04921 | Dado Tappo Serbatoio Vespa 160 Gs E 180 Super Sport | 93598 |
| 04927 | Soffietto Aspirazione Carburatore 160 Gs Vsb1t 1962/64 - 180 Ss Vsc1t 1964/68 | 97366 |
| 04952 | Tampone Ammortizzatore Anteriore 160 Gs Vsb1t 1962>1964 - 180 Ss Vsc1t 1964>1968 | 57997 |
| 04958 | Soffietto Protezione Cavo Freno 125 Vnb3>6t - Vnc1t -Gt - Gtr - 150 VII>VI3t - Vb1t - Vba1t Vbb1>2t - Gs Vs1>Vs5t - Vla1t - Vlb1t - Vsb1t - Vsc1t - Vsd1t - Vse1t | 76354 |
| 04959 | Tampone Ammortizzatore Posteriore Tutti I Modelli Dal 1958 | 60536 |
| 04961 | Anello Braccio Motore Lato Destro | 59589 |
| 04962 | Anello Braccio Motore Lato Sinistro | 59588 |
| 04967 | Tampone Scontro M/Moto 50-90 (3 Marce) - V5a1t>893029 - V5sa1t>69243 - V5ss1t V5ss2t>10379 - V9a1t>141512 - V9ss1t - V9ss2t - 125 Vma1> 2t Fino Al 1977 | 78578 |
| 04967/A | Tampone Scontro M/Moto 50-90-125 Primavera Et3 Dal 1978 | |
| 04968 | Passacavo Comando Frizione 50-90-125 Primavera Et3 | 70219 |
| 04992 | Soffietto Aspirazione 150 Vlb1t Sprint Veloce - 180 Rally Vsd1t 005256> | 97366 |
| 04973 | Guarnizione Tappo Serbatoio 50-90-125 Primavera Et3 | 71734 |
| 08964 | Tassello Volano Magnete Px-Pe Con Lampeggiatori | 133652 |
| 09930 | Soffietto Aspirazione Px Arcobaleno Vlx1 - Vnx1 - Vsx1 - Pe - Vnx5 | 179803 |
| 09934 | Serie Leve Nere Ciao-Si-Bravo | 114222-114223 |
| 09962 | Profilo Serbatoio Si Nero | 446064 |
| 09963 | Profilo Serbatoio Ciao Nero | 228946 |
| 10988 | Bussola Sportello Laterale Vespa 50 - 125 Fl | 241235 |



03972



03974/A



03974
03974-B



★ 04902-GR



04902



★ 04903



★ 04921



★ 03978



03979



★ 04952



04959



★ 04961



★ 04962



★ 08964



04958



04967/A



04967



04968



04973



10988



★ 09963



★ 09962



09930



★ 09934



★ 04927



★ 04992

| <i>Articolo</i> | <i>Descrizione</i> | <i>Simile al Nr. Orig.</i> |
|-----------------|--|----------------------------|
| 00878 | Guarnizione Di Tenuta Fra Coperchio Frizione E Carter (Tipo Grande) | |
| 00878/A | Guarnizione Coperchio Frizione 160 Gs Vsb1t 1962/64 - 180 Ss Vsc1t 1964/68 | 17781 |
| 01609/V | Paio Manopole Per Vespa | |
| 01626/V | Paio Manopole Px - Pe - Arcobaleno 125 - 150 - 200 | |
| 01978 | Guaina per Cavi Diam. 10x12 - Colore Grigio - al Kg. | |
| 03935 | Cappuccio Presa Bassa Tensione 125-'58/61 150-'59/62 | 48170 |
| 04901 | Tappo Depuratore Aria 125 - 150 1958> 180 - 200 Rally - Px - Pe | 50274 |
| 08999/P | Serie Strisce Nere Paracolpi Px - Pe | |
| 09977 | Paraspruzzi Si | |
| 10902 | Prot.Parafango Ant. Si Fl - Ciao Bravo Dal 1991 | 267798 |
| 11981 | Coperchio Manubrio Px Arcobaleno Freno A Disco | 581517 |



★ 00878
00878/A



09977



★ 10902



01609/V

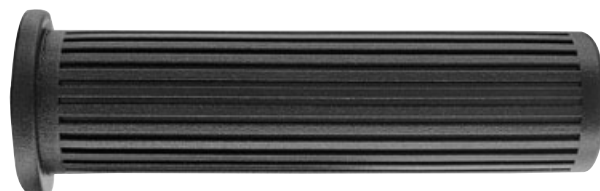

01626/V



11981



03935



04901



01978



08999/P

| <i>Articolo</i> | <i>Descrizione</i> | <i>Simile al Nr. Orig.</i> |
|-----------------|---|----------------------------|
| 00984 | Profilo Nero Per Sacche Fino Al '62 - Kit Per Una Vespa | 51053 |
| 00984-GR | Profilo Grigio Per Sacche Fino Al 61 - Kit Per 1 Vespa | |
| 00984-K | Profilo Per Sacche A Peso | |
| 00984-KGR | Profilo Per Sacche A Peso Colore Grigio | |
| 00984/C | Profilo Nero Per Sacche - Kit Per Una Vespa | 56550-120793 |
| 00984/C-GR | Profilo Grigio Per Sacche - Kit Per Una Vespa | 56550-120793 |
| 00984/C-K | Profilo Nero Per Sacche A Peso In Rotoli | |
| 00984/CKGR | Profilo Per Sacche A Peso Colore Grigio | |
| 00984/D | Profilo Per Sacche Serie Px-Pe - Kit Da 6 Spezzoni | 161995 |
| 00984/D-B | Profilo Per Sacche Serie Px-Pe - Kit Da 6 Spezzoni Bianco | |
| 00984/D-GR | Profilo Per Sacche Grigio - Px Pe - Kit Da 6 Spezzoni | |
| 00984/D-K | Profilato Per Sacche A Peso Nero | |
| 00984/D-KB | Profilo Bianco Per Sacche A Peso | |
| 00984/DKGR | Profilo Per Sacche A Peso Colore Grigio | |
| 00985 | Kit Profili Pedane | 56779 |
| 00985-K | Profilo Pedana A Peso | |
| 00985/A | Kit Profili Pedane | 94625 |
| 00985/A-K | Profilo Pedana A Peso | |
| 00985/B | Kit Profili Pedane Serie Px-Pe | 159829 |
| 00985/B-K | Profilo Pedana A Peso | |
| 02925-K | Profilo Nero Per Targa Al Kg. | |
| 02985 | Profilo Per Pedane Confezione Completa Per Una Vespa | 47243 |
| 02985-K | Profilo Pedana Rotoli A Peso | |
| 02985/A | Profilo Per Pedane Confezione Completa Per Una Vespa | 97237 |
| 03995 | Guarnizione Coperchio Depuratore 150 Cc. | 58853 |
| 03995-K | Guarnizione Coperchio Depuratore 150 Cc. Al Kg. | |
| 08972 | Profilato Nero Per Bauletto Px-Pe - Confezione 5 Pezzi | 183546 |
| 08972/A | Conf. 5 Pezzi Profilato Nero Per Bauletto 50-90-125 Et3 | |
| 08972-K | Profilato Bauletto Nero Al Kg. | |
| 08972-KGR | Profilato Bauletto Grigio Al Kg. | |
| 08973 | Pezzo Profilato Nero Per Scudo - Tutti I Modelli | |
| 08973/5 | Profilato Nero Per Scudo Tutti I Modelli - Conf. 5 Pz. | |



00984/C-GR
00984/CKGR



00984/C
00984/C-K



00984/D-B
00984/D-KB



00984/D-GR
00984/DKGR

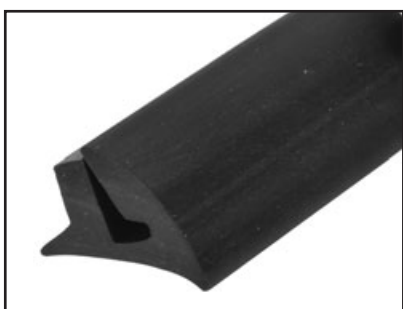

00984/D
00984/D-K



00984-GR
00984-KGR



00984
00984-K



00985/A
00985/A-K



00985/B
00985/B-K



00985
00985-K



08972 - 08972/A
08972-K - 08972-KGR



08973
08973/5



03995
03995-K



02925-K



02985/A

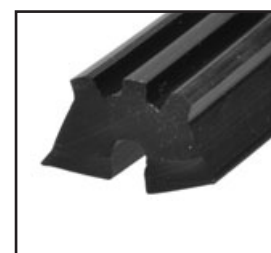

02985
02985-K

TUBETTO BENZINA

| Misura | Descrizione | Confezione | Codice |
|--------|--|------------|------------|
| 6 x 9 | Verde Trasparente | 100 metri | 01958/A-V |
| 6 x 9 | Nero | 10 metri | 01958/A/10 |
| 6 x 9 | Verde Trasparente | 10 metri | 01958/A10V |
| 6 x 9 | Viola Doppio Strato Per Benzina Senza Piombo | 10 metri | 01958/A10S |
| 6 x 13 | Verde Trasparente | 50 metri | 01902-V |
| 6 x 13 | Nero | 10 metri | 01902/10 |
| 6 x 13 | Verde Trasparente | 10 metri | 01902/10-V |

SERIE PARAOLIO MOTORE

| Descrizione | Codice |
|--|----------------------|
| Carburatore 150 Cc. 2% | 07872 |
| Gs '62-64 Usb/1 | Old Model 08853 |
| Ss 180 | Old Model 08853/A |
| 125 '60/62-150 '61/62 (Motore + Carburatore) | 08856 |
| 50-90-125 Primavera-Et3-Ape 50 Cc. | 08865 |
| 125 Primavera | 08865/A |
| 50-90-125 Primavera-Et3 - Senza O.R. | 08865/B |
| Ciao 2^ Serie | Old Model 08883 |
| 150 Sprint-Gl '59/64 | 09865 |
| 150 1966 | 09866 |
| Ciao-Boxer-Bravo Monomarcia Senza Variatore | 10867 |
| Ciao-Boxer-Bravo Monomarcia Con Variatore | 10868 |
| Serie Px Fino All'83-125 Ts - Senza O.R. | 10876 |
| Serie Px Dall'83 | 10876/A |
| Serie Px Fino All'83-125 Ts - Con O.R. | 10877 |
| Serie Px Dall'87-T5-Serie Cosa | 11867 |
| Px 50 Xl-FI2-Ape 50 Tmp-Vespa Hp 4 M. | 11872 |
| Vespa Pk 50 - Xl - FI2 | 11872/B |
| Grillo Monomarcia | 11883 |
| Sfera Rst 125 - Vespa Et4 | 12856 |

PARAOLIO SINGOLI - CIAO - BOXER - BRAVO - SI

| Misura | Descrizione | Simile al | Codice |
|-----------------|--------------------------------------|-----------|--------|
| VC 19 13 3 | Per Ceppo Freno Posteriore | S8966 | P/011 |
| VC 22 13 4 | Per Ceppo Freno Posteriore | S/17002 | P/019 |
| VC 22 16 3 | Per Puleggia Motrice | S/8769 | P/022 |
| VC 23 17 3 | Per Mozzo | 103608 | P/023 |
| DC 24 15 5 | Per Albero Motore Lato Volano | 112978 | P/027 |
| VC 24 18 4 | Per Albero Motore Lato Frizione | S/8771 | P/035 |
| SC 25 17 4 | Per Coperchio Carter Motore | 114469 | P/038 |
| SC 30 20 5 | Per Mozzo Posteriore 2a Serie | 131511 | P/076 |
| SC 35 22 6 | Per Albero Ruota Posteriore 1a Serie | S/8752 | P/115 |
| TBY 35 25,7 7/9 | Per Forcella Bravo - Si | 2/123196 | P/124 |

VESPA 50 - 90 - 125 PRIMAVERA - 125 ET3

| Misura | Descrizione | Simile al | Codice |
|--------------|---------------------------------|----------------|--------|
| SC 32 19 7 | Per Albero Motore Lato Volano | S/8720 - 15579 | P/089 |
| SC 37 27 7 | Per Mozzo Ruota Posteriore | 3/46699 | P/130 |
| SC 40 17 7 | Per Mozzo Ruota Anteriore | S/8722 | P/139 |
| TC 40 24 7 | Per Mozzo Ruota Anteriore | S/8708 | P/148 |
| SC 40 25 7 | Per Mozzo Ruota Anteriore | 128217 | P/150 |
| SC 47 22,7 7 | Per Albero Motore Lato Frizione | S/8731 | P/189 |

VESPA 125 TS DAL 1975

| Misura | Descrizione | Simile al | Codice |
|-------------------|---------------------------------|-----------|--------|
| HSCR 35 24 6 | Per Albero Motore Lato Volano | 158962 | P/120 |
| SC 40 17 7 | Per Mozzo Ruota Anteriore | S/8722 | P/139 |
| SC 47 27 6 | Per Mozzo Ruota Posteriore | 130536 | P/192 |
| SCY 62 31 5,8/4,3 | Per Albero Motore Lato Frizione | 131102 | P/256 |

VESPA P125X - P150X - PX 125 E - PX 150 E

| Misura | Descrizione | Simile al | Codice |
|-------------------|---------------------------------|-----------|--------|
| SC 27 19 6 | Per Mozzo Ruota Anteriore | 174887 | P/046 |
| HSCR 35 24 6 | Per Albero Motore Lato Volano | 158962 | P/120 |
| SC 47 27 6 | Per Mozzo Ruota Posteriore | 130536 | P/192 |
| SCY 62 31 5,8/4,3 | Per Albero Motore Lato Frizione | 131102 | P/256 |

VESPA P200E

| Misura | Descrizione | Simile al | Codice |
|-------------------|---------------------------------|-----------|--------|
| SC 27 19 6 | Per Mozzo Ruota Anteriore | 174887 | P/046 |
| HSCR 35 24 6 | Per Albero Motore Lato Volano | 158962 | P/120 |
| SC 47 27 6 | Per Mozzo Ruota Posteriore | 130536 | P/192 |
| SCY 62 31 5,8/4,3 | Per Albero Motore Lato Frizione | 131102 | P/256 |

| <i>Articolo</i> | <i>Descrizione</i> | <i>Simile al Nr. Orig.</i> |
|-----------------|---|----------------------------|
| 01678 | Paio Manopole Scooters Piaggio Per Tutti I Modelli | 274489-274490 |
| 10959 | Manicotto Integrale Carburatore Piaggio 50 : Free-Delivery-Nrg Rst-Mc2-Mc3 Extreme-Diesis-Liberty-Ntt-Sferarst50 - Sfera Maquillage2-Et2-Zip-Zip95 Zip Fast Rider-Zip Sp-Zip Rst-Zip Fast Rider Rst-Zip Fd- 80 Skr City | 288029-436095 |
| 10966 | Ventola Raffreddamento Tutti I Modelli Piaggio-Gilera | 289338 |
| 10986 | Ventola Frizione Scooters Piaggio Tutti I Modelli | 287044 |
| 11940 | Cinghia Pompa Miscelatore Automatico Piaggio 80 - 125 -150 | 431370 |
| 11948 | Ventola Frizione Scooter Piaggio | 480410 |
| 12979 | Raccordo Carburatore Piaggio X9 - Beverly 200 | 484748 |
| 12980 | Soffietto Carburatore Filtro Piaggio Liberty 50 - 125 - Leader 150 | 576773 |
| 12981 | Raccordo Carburatore Piaggio Beverly 250 | 840949 |



10959



12979



12981



10966



12980

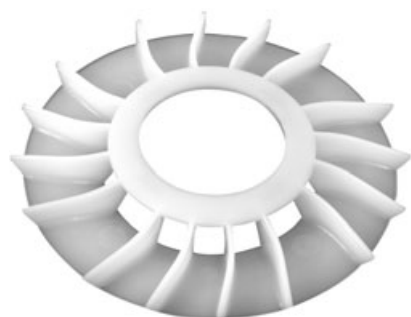

11948

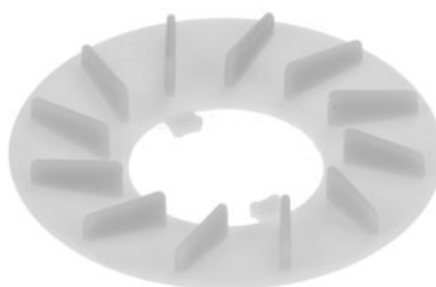

10986



11940



01678

| <i>Articolo</i> | <i>Descrizione</i> | <i>Simile al Nr. Orig.</i> |
|-----------------|--|----------------------------|
| 12942 | Deflettore Posteriore Sinistro Beverly 500 | CM016901000C |
| 12943 | Deflettore Posteriore Destro Beverly 500 | CM016902000C |
| 12944 | Pedana Anteriore Destra Beverly 500 | CM01420400E8 |
| 12945 | Pedana Anteriore Sinistra Beverly 500 | CM01420300E8 |
| 12946 | Pedana Anteriore Sinistra Beverly 250 | CM014203000P |
| 12947 | Pedana Anteriore Destra Beverly 250 | CM014204000P |
| 12976 | Deflettore Sx Beverly 125/250/400/500 Euro 3 | CM008501000C |
| 12977 | Deflettore Dx Beverly 125/250/400/500 Euro 3 | CM008502000C |



12977



12942
12943



12976



12944
12945
12946
12947

| <i>Articolo</i> | <i>Descrizione</i> | <i>Simile al Nr. Orig.</i> |
|-----------------|---|----------------------------|
| 01683 | Paio Manopole Liberty | 58582 |
| 01683-M | Paio Manopole Liberty - Marrone | |
| 11959 | Spoiler Liberty 50-125-150-200 Cc - 4 Tempi | 575685000D |
| 11978 | Serie Strisce Pedane Liberty 50-125-150 | 573983 |
| 11979 | Pavimento Liberti 50-125-150 | 576907000D |
| 12940 | Pavimento Liberty 125-150-200 4t | 621204000D |
| 12941 | Coprimanubrio Posteriore Liberty 125-150-200 4t | 621174000D |



11979



12940



12941



11978



11959



01683
01683-M

| <i>Articolo</i> | <i>Descrizione</i> | <i>Simile al Nr. Orig.</i> |
|-----------------|--|----------------------------|
| 11954 | Deflettore Sinistro Liberty 50 Cc | 5609440043 |
| 11956 | Deflettore Destro Liberty 50 Cc | 5609450043 |
| 11957 | Deflettore Sinistro Liberty 125 Cc | 5744720043 |
| 11958 | Deflettore Destro Liberty 125 Cc | 5744730043 |
| 11980 | Coprimanubrio Posteriore Liberty 50-125-150 Vespa Et2 | 580978000D |
| 11982 | Deflettore Sinistro Posteriore Liberty 150 | 5744780043 |
| 11983 | Deflettore Destro Posteriore Liberty 150 | 574770043 |
| 11984 | Coprimanubrio Anteriore Liberty 50-125-150- Vespa Et 125-150 | 4272005 |
| 12936 | Protezione Carena Destra Liberty 125-150-200 4t | CM0201010043 |
| 12937 | Protezione Carena Sinistra Liberty 125-150-200 4t | CM201020043 |
| 12938 | Deflettore Destro Liberty 125-150-200 4t | CM0200020043 |
| 12939 | Deflettore Sinistro Liberty 125-150-200 4t | CM0200010043 |
| 12972 | Deflettore Sx Liberty50 2t- 125 4t - 200 4t Euro 3 | CM02000100EO |
| 12973 | Deflettore Dx Liberty 50 2/4t - 125/200 4t Euro 3 | CM02000200EO |
| 12974 | Protezione Laterale Sx Liberty 50/2/4t- 125/200 4 T Euro 3 | CM020102000P |
| 12975 | Protezione Laterale Dx Liberty50/2/4t - 125/200 4t Euro 3 | CM020101000P |



11957
11958



12936
12937



11982
11983



12974
12975



11954
11956



12938
12939
12972
12973



11984



11980

TUBETTO BENZINA

| Misura | Descrizione | Confezione | Codice |
|--------|-------------------|------------|------------|
| 6 x 13 | Verde Trasparente | 50 metri | 01902-V |
| 6 x 13 | Nero | 10 metri | 01902/10 |
| 6 x 13 | Verde Trasparente | 10 metri | 01902/10-V |

SERIE PARAOLIO MOTORE

| | Descrizione | simile al | Codice |
|--|---|-----------|----------|
| | Sfera 50-80-Zip-Zip Fast Rider-Quartz-Free-Et2 - Vespa 50 Et2 | | 11891 |
| | Come Sopra (Prezzo Economico) | | 11891/AE |
| | Scooter Tutti I Modelli Raffr. A Liquido | 498471 | 12852 |
| | Tipo Economico Scooters Raffr.A Liquido | | 12852/AE |
| | Liberty 50 | | 12854 |
| | Hexagon 125/150 | | 12855 |
| | Sfera Rst 125 - Vespa Et4 | | 12856 |
| | Albero Motore Piaggio 50 Cc (2 Paraolio) | | 12860 |

PARAOLIO SINGOLI - SCOOTERS PIAGGIO

| Misura | Descrizione | simile al | Codice |
|--------------|---------------------------------|-----------|--------|
| TC 28 18 7 | Per Albero Motore Lato Volano | 145597 | P/179 |
| TCRV 30 19 7 | Per Albero Motore Lato Frizione | 239391 | P/327 |
| SC 40 22 7 | Per Albero Ruota Posteriore | 239848 | P/146 |
| SC 47 30 6 | Per Asse Ruota Posteriore | 8717 | P/195 |
| KBC2 47 40 4 | Per Puleggia Condotta | 478269 | P/328 |

MANICOTTI CARBURATORE

| | Descrizione | simile al | Codice |
|--|--|-----------|--------|
| | Sfera - Zip - Quartz - Vespa Et2 -Nrg - Free | 436095 | 10959 |
| | Hexagon 125/150 - Skipper 125/150 | 430206 | 11977 |

CINGHIE DI TRASMISSIONE

| cm3 | Modello | simile | Anno | Codice Standard | Codice Kevlar | Codice Doppia |
|-----|---|---------------|----------|-----------------|---------------|---------------|
| 50 | Business 50 | | | 10964 | 10964/K | |
| 50 | Diesis 2T | 436864 | (01/>) | 10964 | 10964/K | |
| 50 | Diesis 2T (oil pump belt) | 286162 | (01/>) | 11924 | | |
| 50 | Fly 2T (oil pump belt) | 286162 | (05/08) | 11924 | | |
| 50 | Fly 2T 50 | 82712R | (04/>) | 11953 | 11953/K | |
| 50 | Fly 2T 50 | 842907 | (04/>) | 11965 | 11965/K | |
| 50 | Fly 4T | 842907 | (05/08) | 11965 | 11965/K | |
| 50 | Fly 50 | | | | 11988/K | |
| 50 | Free 50 | 430728 | (92/00) | 10996 | 10996/K | |
| 50 | Free Delivery | 436864 | (00/>) | 10964 | 10964/K | |
| 50 | Free FL | 436864 | (02/>) | 10964 | 10964/K | |
| 50 | Free FL | 430728 | (95/01) | 10996 | 10996/K | |
| 50 | Free/FL/Delivery (oil pump belt) | 286162 | (92/>) | 11924 | | |
| 50 | Liberty 2T | 82712R | (06/08) | 11953 | 11953/K | |
| 50 | Liberty 2T | 480852/82712R | (97/05) | 11953 | 11953/K | |
| 50 | Liberty 2T 50 | 480852/82712R | (97/03) | 11953 | 11953/K | |
| 50 | Liberty 2T 50 | 82712R | (04/>) | 11953 | 11953/K | |
| 50 | Liberty 2T PTT EU2 | 82712R | (04/06) | 11953 | 11953/K | |
| 50 | Liberty 2T Rst | 82712R | (04/06) | 11953 | 11953/K | |
| 50 | Liberty 2T Sport | 82712R | (06/08) | 11953 | 11953/K | |
| 50 | Liberty 2T/Rst/Sport/PTT EU2 | 286162 | (97/08) | 11924 | | |
| 50 | Liberty 4T | 480852/82712R | (00/03) | 11953 | 11953/K | |
| 50 | Liberty 4T Rst | 82712R | (04/08) | 11953 | 11953/K | |
| 50 | Liberty 4T Sport | 82712R | (06/07) | 11953 | 11953/K | |
| 50 | Liberty 4T Sport Euro 3 | 82712R | (07/08) | 11953 | 11953/K | |
| 50 | Liberty 50 le 4t | 480852/82712R | (01/...) | 11953 | 11953/K | |
| 50 | Liberty 50 le 4t | 480852/82712R | (04/...) | 11953 | 11953/K | |
| 50 | NRG 50 | 430728 | (94/96) | 10996 | 10996/K | |
| 50 | NRG Extreme | 4386864 | (99/01) | 10964 | 10964/K | |
| 50 | NRG MC | 436864/286162 | | 10964 | 10964/K | |
| 50 | NRG MC? 50 | 430728 | (94/97) | 10996 | 10996/K | |
| 50 | NRG MC3 | 436864 | (01/04) | 10964 | 10964/K | |
| 50 | NRG MC? 50 | 4386864 | (01/02) | 10964 | 10964/K | |
| 50 | NRG Power DD | 436864 | (05/08) | 10964 | 10964/K | |
| 50 | NRG Power DT | 436864 | (06/08) | 10964 | 10964/K | |
| 50 | NRG Power PureJet 50 | 833982 | (04/05) | 10964 | 10964/K | |
| 50 | NRG PureJet | 436864 | (02/04) | 10964 | 10964/K | |
| 50 | NRG Rst MC2 (DD) | 436864 | (98) | 10964 | 10964/K | |
| 50 | NRG Rst MC2 (DT) | 430728 | (96/97) | 10996 | 10996/K | |
| 50 | NRG/Rst MC2/Extreme/MC3/ PureJet/Power/DD/DT (oil pump belt) | 286162 | (94/08) | 11924 | | |
| 50 | NTT | 430728 | (95/96) | 10996 | 10996/K | |

CINGHIE DI TRASMISSIONE

| cm3 | Modello | simile | Anno | Codice Standard | Codice Kevlar | Codice Doppia |
|-----|---|---------------|----------|-----------------|---------------|---------------|
| 50 | NTT (oil pump belt) | 286162 | (95/96) | 11924 | | |
| 50 | NTT 50 | 430728 | (94/96) | 10996 | 10996/K | |
| 50 | Quartz | 431190/289432 | (92/96) | 11924 | | |
| 50 | Quartz (oil pump belt) | 286162 | (92/96) | 11924 | | |
| 50 | Quartz 50 | 431190/289432 | (92/96) | 11924 | | |
| 50 | Runner 50 | | | | 11950/K | |
| 50 | Sfera 50 | 431190 | (95/97) | 11924 | | |
| 50 | Sfera FL Rst | 431190 | (95/97) | 11924 | | |
| 50 | Sfera II | 286162 | | 11924 | | |
| 50 | Sfera Maquillage 2 | 431190 | (<94) | 11924 | | |
| 50 | Sfera/Maquillage 2/FL Rst (oil pump belt) | 286162 | (91/97) | 11924 | | |
| 50 | Typhoon 50 | 436864 | (01/...) | 10964 | 10964/K | |
| 50 | Typhoon X 50 | 436864 | (01/...) | 10964 | 10964/K | |
| 50 | Typhoon X-R | 436864 | (01/08) | 10964 | 10964/K | |
| 50 | Typhoon X-R (oil pump belt) | 286162 | (01/08) | 11924 | | |
| 50 | Vespa ET2 | 431190 | (04/98) | 11924 | | |
| 50 | Vespa ET2 | 431190 | (97/01) | 11924 | | |
| 50 | Vespa ET2 | 828223/82645R | (98/>) | | 11929/K | |
| 50 | Vespa ET2 (Injection) 50 | 828223/82645R | (97/00) | | 11929/K | |
| 50 | Vespa ET2 (oil pump belt) | 286162 | (97/05) | 11924 | | |
| 50 | Vespa ET2 Injection | 828223/82645R | (97/00) | | 11929/K | |
| 50 | Vespa ET2 Injection (oil pump belt) | 480341 | (97/00) | | 11988/K | |
| 50 | Vespa ET2 Injection (oil pump belt) | 480135 | (98/00) | | 11988/K | |
| 50 | Vespa ET4 | 828223/82645R | (00/05) | | 11929/K | |
| 50 | Vespa LX 2T | 828223/82645R | (04/>) | | 11929/K | |
| 50 | Vespa LX 2T (oil pump belt) | 286162 | (05/08) | 11924 | | |
| 50 | Vespa LX 4T | 828223/82645R | (05/08) | | 11929/K | |
| 50 | Vespa LX 4T | 828223/82645R | (04/>) | | 11929/K | |
| 50 | Vespa LXV 2T | 82645R | (06/08) | | 11929/K | |
| 50 | Vespa LXV 2T (oil pump belt) | 286162 | (06/08) | 11924 | | |
| 50 | Vespa S Special 2T | 82645R | (07/08) | | 11929/K | |
| 50 | Vespa S Special 2T (oil pump belt) | 286162 | (07/08) | 11924 | | |
| 50 | XR 50 | | | 10964 | 10964/K | |
| 50 | Zip (94-) 50 | | (95/96) | 11924 | | |
| 50 | Zip 2000 (sp) 50 | | | | 11929/K | |
| 50 | Zip 4T | 828223/82645R | (00/08) | | 11929/K | |
| 50 | Zip Base | 431190 | (95/96) | 11924 | | |
| 50 | Zip Base | 286162 | (92/96) | 11924 | | |
| 50 | Zip Cat. 2T | 286162 | (00/08) | 11924 | | |
| 50 | Zip Cat. 2T | 828223/82645R | (00/08) | | 11929/K | |
| 50 | Zip Fast Rider | 431190/286162 | (93/99) | 11924 | | |

CINGHIE DI TRASMISSIONE

| cm3 | Modello | simile | Anno | Codice Standard | Codice Kevlar | Codice Doppia |
|-----|---------------------------------------|---------------|----------|-----------------|---------------|---------------|
| 50 | Zip Fast Rider 50 | 431190 | (93/99) | 11924 | | |
| 50 | Zip Fast Rider/Rst | 286162 | (93/99) | 11924 | | |
| 50 | Zip Fast/Rider/Rst | 431190 | (93/99) | 11924 | | |
| 50 | Zip Rst | 431190 | (96/99) | 11924 | | |
| 50 | Zip Rst | 286162 | (96/99) | 11924 | | |
| 50 | Zip SP | 431190 | (96/00) | 11924 | | |
| 50 | Zip SP | 828223/82645R | (01/08) | | 11929/K | |
| 50 | Zip SP (oil pump belt) | 286162 | (96/00) | 11924 | | |
| 50 | Zip SP (oil pump belt) | 286462 | (01/08) | | 11988/K | |
| 80 | Skr city | 430719/431370 | (99/..) | | 11928/K | |
| 100 | Fly 4T | 82619R | (06/08) | 11965 | 11965/K | |
| 100 | Free 4T 100 | 82619R | (02/>) | 11965 | 11965/K | |
| 100 | Zip 4T | 82645R | (06/08) | | 11929/K | |
| 125 | Beverly 125 | 829366/842009 | (01/03) | | 11987/K | |
| 125 | Beverly Euro 3/Sport/MIC | 842009 | (07/08) | | 11989/K | |
| 125 | Beverly RST 125 | 842009 | (04/>) | | 11989/K | |
| 125 | Carnaby | 842009 | (07/08) | | 11989/K | |
| 125 | Fly | 841213 | (05/08) | | 11930/K | |
| 125 | Hexagon 2T | 431370 | (94/99) | | 11928/K | |
| 125 | Hexagon GTX 4T | 832023/841213 | (00/...) | | 11930/K | |
| 125 | Hexagon gtx 4T 125 | 832023/841213 | (00/...) | | 11930/K | |
| 125 | Hexagon LX 125 | 431370 | (94/99) | | 11928/K | |
| 125 | Hexagon LX 2T | 434812 | (98/99) | | 11928/K | |
| 125 | Hexagon LX 2T (oil pump belt) | 431370 | (94/99) | | 11928/K | |
| 125 | Hexagon LX4 4T | 484758 | (98/>) | | 11988/K | |
| 125 | Hexagon LX4125 | 434812/825059 | (98/99) | | 11988/K | |
| 125 | Liberty | 484758 | (98/99) | | 11988/K | |
| 125 | Liberty | 825059 | (00) | | 11988/K | |
| 125 | Liberty (Leader) | 832023 | (00/03) | | 11930/K | |
| 125 | Liberty 125 | 825059 | (00) | | 11988/K | |
| 125 | Liberty 4T Sport/Euro 3 | 841213 | (06/08) | | 11930/K | |
| 125 | Liberty Leader 125 | 832023/841213 | (00/...) | | 11930/K | |
| 125 | Liberty PTT | 841213 | (06/06) | | 11930/K | |
| 125 | Liberty Rst 125 | 841213 | (04/>) | | 11930/K | |
| 125 | Liberty Rst/Euro 3 | 841213 | (04/08) | | 11930/K | |
| 125 | MP3 | 841213 | (07/08) | | 11930/K | |
| 125 | Sfera FL 4T | 434807/478547 | (95/97) | 11965 | 11965/K | |
| 125 | Sfera II125 | 434807 | | | 11929/K | |
| 125 | Skipper 125 2T (frame nr. till 14740) | | 231258 | (95/97) | | 11928/K |
| 125 | Skipper 125 2T(frame nr. from 14741) | | 434812 | (93/97) | | 11928/K |
| 125 | Skipper 125 4T | 832023/841213 | (00/>) | | 11930/K | |
| 125 | Skipper 125 LX 2T | 434812 | (98/99) | | 11928/K | |

CINGHIE DI TRASMISSIONE

| cm3 | Modello | simile | Anno | Codice Standard | Codice Kevlar | Codice Doppia |
|-----|-----------------------------------|---------------|----------|-----------------|---------------|---------------|
| 125 | Skipper 2T (from frame nr. 14741) | 434812 | (93/97) | | 11928/K | |
| 125 | Skipper 2T (till frame nr. 14740) | 431258 | (93/97) | | 11928/K | |
| 125 | Skipper 2T/LX 2T (oil pump belt) | 431370 | (93/99) | | 11928/K | |
| 125 | Skipper Leader 125 | | (00/...) | | 11930/K | |
| 125 | Skipper LX 2T | 434812 | (98/99) | | 11928/K | |
| 125 | Skipper ST 4T | 832023/841213 | (00/05) | | 11930/K | |
| 125 | SuperHexagon GTX 125 | 832023/841213 | (00) | | 11930/K | |
| 125 | SuperHexagon GTX 4T | 832023/841213 | (01/>) | | 11930/K | |
| 125 | Typhoon 125 | | | | 11928/K | |
| 125 | Vespa ET 4 125 | 434807/478547 | (97/99) | 11965 | 11965/K | |
| 125 | Vespa ET 4 Leader 125 | 832023/841213 | (99/00) | | 11930/K | |
| 125 | Vespa ET4 (Leader) | 832023/841213 | (00/05) | | 11930/K | |
| 125 | Vespa GT 125 | | (03) | | 11930/K | |
| 125 | Vespa GT Granturismo/Euro 3 | 832023/841213 | (03/08) | | 11930/K | |
| 125 | Vespa GTS Euro 3 | 841213 | (07/08) | | 11930/K | |
| 125 | Vespa GTV | 841213 | (07/08) | | 11930/K | |
| 125 | Vespa LX 125 | 841213 | (04/>) | | 11930/K | |
| 125 | Vespa LX/Euro 3 | 841213 | (05/08) | | 11930/K | |
| 125 | Vespa LXV 4T Euro 3 | 841213 | (06/08) | | 11930/K | |
| 125 | Vespa S Special Euro 3 | 841213 | (07/08) | | 11930/K | |
| 125 | X7 | 841213 | (07/08) | | 11930/K | |
| 125 | X8 125 | 841213 | (04/>) | | 11930/K | |
| 125 | X8 Street Euro | 841213 | (06/07) | | 11930/K | |
| 125 | X8/Premium Euro 2 | 841213 | (04/06) | | 11930/K | |
| 125 | X9 125 | 832023/841213 | (01/02) | | 11930/K | |
| 125 | X9/Evolution/Euro 3 | 832023/841213 | (01/07) | | 11930/K | |
| 125 | X-EVO | 841213 | (07/08) | | 11930/K | |
| 125 | Zip 4T | 832023/841213 | (00/06) | | 11930/K | |
| 125 | Zip 4T 125 | 832023/841213 | (00/...) | | 11930/K | |
| 125 | Zip Leader 125 | | | | 11930/K | |
| 150 | Fly | 841213 | (05/08) | | 11930/K | |
| 150 | Fly 150 | 841213 | (04/>) | | 11930/K | |
| 150 | Hexagon 150 | 434812 | (94/97) | | 11928/K | |
| 150 | Hexagon 2T | 434812 | (94/97) | | 11928/K | |
| 150 | Hexagon 2T (oil pump belt) | 431370 | (94/97) | | 11928/K | |
| 150 | Liberty | 832023/841213 | (99/03) | | 11930/K | |
| 150 | Liberty 150 | | (00/...) | | 11929/K | |
| 150 | Liberty Leader 150 | 832023/841213 | (00/...) | | 11930/K | |
| 150 | Skipper 150 4T | | (00/02) | | 11928/K | |
| 150 | Skipper 150 Lxt | 434812 | (98/99) | | 11928/K | |
| 150 | Skipper 2T (da tel. N. 14741) | 434812 | (93/97) | | 11928/K | |
| 150 | Skipper 2T (fino a tel. N. 14740) | 431258 | (93/97) | | 11928/K | |

CINGHIE DI TRASMISSIONE

| cm3 | Modello | simile | Anno | Codice Standard | Codice Kevlar | Codice Doppia |
|-----|-----------------------------------|---------------|----------|-----------------|---------------|---------------|
| 150 | Skipper 2T 150 | 431258 | (94/97) | | 11928/K | |
| 150 | Skipper 2T 150 | 832023/841213 | (94/97) | | 11930/K | |
| 150 | Skipper 2T/LX 2T (oil pump belt) | 431370 | (93/99) | | 11928/K | |
| 150 | Skipper Leader 150 | | | | 11930/K | |
| 150 | Skipper LX 2T | 434812 | (98/99) | | 11928/K | |
| 150 | Skipper ST 4T | 832023/841213 | (00/05) | | 11930/K | |
| 150 | Vespa ET 4 150 | 832023/841213 | (00/...) | | 11930/K | |
| 150 | Vespa ET 4 Leader 150 | | (00/>) | | 11930/K | |
| 150 | Vespa ET4 | 832023/841213 | (99/05) | | 11930/K | |
| 150 | Vespa LX 150 | 841213 | (04/>) | | 11930/K | |
| 150 | Vespa LX/Euro 3 | 841213 | (05/08) | | 11930/K | |
| 150 | X8 Street Euro 2 | 841213 | (06/07) | | 11930/K | |
| 180 | Hexagon 180 LXT 2T | 484497 | (98/...) | | 11928/K | |
| 180 | Hexagon GTX 4T | 827639/832623 | (00) | | | 12988/D |
| 180 | Hexagon LXT 2T | 484497 | (98/99) | | 11928/K | |
| 180 | Hexagon LXT 2T (oil pump belt) | 431370 | (98/99) | | 11928/K | |
| 180 | Super Hexagon GTX 4T 4V 180 | 832623/840908 | (00/>) | | | 12988/D |
| 180 | SuperHexagon GTX 4T | 827639/832623 | (01/>) | | | 12988/D |
| 180 | X9 Amalfi 180 | 832623/840908 | | | | 12988/D |
| 200 | Beverly 200 | 828043/842011 | (01/03) | | | 12989/D |
| 200 | Beverly/Rst | 828043/842011 | (04/06) | | | 12989/D |
| 200 | Carnaby | 842011 | (07/08) | | | 12989/D |
| 200 | Liberty Rst 200 | 840908 | (04/>) | | | 12988/D |
| 200 | Liberty Rst/Euro 3 | 840908 | (04/08) | | | 12988/D |
| 200 | Liberty Sport/Euro 3 | 840908 | (06/08) | | | 12988/D |
| 200 | Vespa GT Granturismo | 840908 | (03/08) | | | 12988/D |
| 200 | Vespa GT L 200 | 840908 | (03) | | | 12988/D |
| 200 | X8 | 840908 | (04/06) | | | 12988/D |
| 200 | X8 200 | 840908 | | | | 12988/D |
| 200 | X9 | 832623/840908 | (02/03) | | | 12988/D |
| 200 | X9 200 | 832623/840908 | (02/03) | | | 12988/D |
| 200 | X9 evolution 200 | 832623/840908 | (03) | | | 12988/D |
| 200 | X9/Evolution | 832623/840908 | (03/>) | | | 12988/D |
| 250 | Beverly (Carburator) | 841851 | (06/07) | | | 12988/D |
| 250 | Beverly 250 | 841851 | (04/>) | | | 12988/D |
| 250 | Beverly Cruiser | 841851 | (07/08) | | | 12988/D |
| 250 | Beverly IE Euro 3/MIC (Injection) | 841851 | (06/08) | | | 12988/D |
| 250 | Beverly Rst (Carburator) | 841851 | (05/05) | | | 12988/D |
| 250 | Beverly Sport | 841851 | (06/08) | | | 12988/D |
| 250 | Beverly Tourer | 841851 | (08/>) | | | 12988/D |
| 250 | Hexagon GT | 495158 | (98/99) | | 11928/K | |
| 250 | Hexagon GT 250 | 495158 | (98/99) | | 11928/K | |

CINGHIE DI TRASMISSIONE

| cm3 | Modello | simile | Anno | Codice Standard | Codice Kevlar | Codice Doppia |
|-----|------------------------|---------------|---------|-----------------|---------------|---------------|
| 250 | MP3 | 843963 | (06/08) | | | 12990/D |
| 250 | SuperHexagon GTX | 495158 | (00/>) | | 11928/K | |
| 250 | Superhexagon GTX 250 | 495158 | (00/>) | | 11928/K | |
| 250 | Vespa GT 60 Euro 3 | 843963 | (06/08) | | | 12990/D |
| 250 | Vespa GTS | 843963 | (05/08) | | | 12990/D |
| 250 | Vespa GTV | 843963 | (06/08) | | | 12990/D |
| 250 | X7 | 843963 | (07/08) | | | 12990/D |
| 250 | X8 | 843963 | (05/08) | | | 12990/D |
| 250 | X9 (Honda) | 496304 | (00/03) | | 11990/K | |
| 250 | X9 250 | 496304/843963 | (00) | | | 12990/D |
| 250 | X9 250 quasar | | (00) | | | 12990/D |
| 250 | X9 Evolution (Piaggio) | 843963 | (04/07) | | | 12990/D |
| 250 | X-EVO | 843963 | (07/08) | | | 12990/D |
| 400 | Beverly i.e. | 832738 | (06/08) | | | 12991/D |
| 400 | MP3 | 832738 | (07/08) | | | 12991/D |
| 400 | X8 | 832738 | (06/08) | | | 12991/D |
| 400 | X-EVO | 832738 | (07/08) | | | 12991/D |
| 500 | Beverly | 832738 | (02/06) | | | 12991/D |
| 500 | Beverly Cruiser | 832738 | (07/08) | | | 12991/D |
| 500 | Beverly Euro 3 | 832738 | (06/08) | | | 12991/D |
| 500 | X9 | 832726 | (00/02) | | | 12991/D |
| 500 | X9 500 | 827826 | (01/04) | | | 12991/D |
| 500 | X9 EvolutioBS | 832738 | (03/08) | | | 12991/D |
| 500 | X9 Evolution 500 | 832738 | (03/>) | | | 12991/D |

ARI KITS PARAOLIO FORCELLA

| cm3 | Modello | Anno | Codice | Simile al |
|-----|-------------------|-----------|---------|-----------------|
| 50 | Free | 92-99 | ARI.075 | 269603 |
| 50 | Liberty | 97-> | ARI.079 | 563238 |
| 50 | NRG | ->99 | ARI.076 | |
| 50 | NRG MC2 Ferrari | ————— | ARI.075 | |
| 50 | NRG Power DD | 2004-2005 | ARI.112 | 564236 |
| 50 | NRG Power Purejet | 2004-2005 | ARI.112 | 564236 |
| 50 | NTT | 95-98 | ARI.075 | 269603 |
| 50 | ZIP SP H2O | 99-> | ARI.075 | 269603 |
| 50 | ZIP-Fast Rider | 93-97 | ARI.075 | 269603 |
| 125 | Beverly 125 | 2004-2005 | ARI.061 | 497010/600268 |
| 125 | Liberty | 99 | ARI.103 | 494770 |
| 125 | Liberty 125 4T | 2004-2005 | ARI.133 | 494771 / 599201 |
| 125 | Skipper | 98-> | ARI.112 | 564236 |
| 125 | X 8 125 4T | 2004-2005 | ARI.061 | 497010/600268 |
| 150 | Skipper | 98-> | ARI.112 | 564236 |

ARI KITS PARAOLIO FORCELLA

| cm3 | Modello | Anno | Codice | Simile al |
|-----|-----------------------|-----------|---------|-----------------|
| 200 | Beverly | 2001-2002 | ARI.061 | 497010/600268 |
| 200 | Liberty 200 4T | 2004-2005 | ARI.133 | 494771 / 599201 |
| 200 | X 8 200 4T | 2004-2005 | ARI.061 | 497010/600268 |
| 250 | Beverly 250 | 2004-2005 | ARI.061 | 600268 |
| 250 | X 9 | 2000-> | ARI.061 | 497010 |
| 250 | X 9 Evolution 150 | 2004-2005 | ARI.061 | 497010/600268 |
| 460 | Beverly 500 | 2004-2005 | ARI.102 | 599267 |
| 460 | X 9 500 Street | 2004-2005 | ARI.023 | 599501 |
| 460 | X 9 Evolution 500 | 2004-2005 | ARI.023 | 599501 |
| 460 | X 9 Evolution 500 ABS | 2004-2005 | ARI.023 | 599501 |
| 500 | X 9 | 2000-> | ARI.061 | 497010 |

PIAGGIO GILERA

| Articolo | Descrizione | Simile al Nr. Orig. |
|----------|-------------|---------------------|
|----------|-------------|---------------------|

| | | |
|-------|--|--------|
| 10959 | Manicotto Integrale Scooters 50 Cc- Runner - Typhoon - Stalker - Storm - Easy Mov. | 436095 |
| 10966 | Ventola Raffreddamento Tutti I Modelli Piaggio Gilera | 289338 |
| 11977 | Manicotto Integrale Scooters Runner 125/180 - Typhoon 125-Skipper 125/150 | 430206 |



11977



10959



10966

TUBETTO BENZINA

| Misura | Descrizione | Confezione | Codice |
|--------|-------------------|------------|------------|
| 6 x 13 | Verde Trasparente | 50 metri | 01902-V |
| 6 x 13 | Nero | 10 metri | 01902/10 |
| 6 x 13 | Verde Trasparente | 10 metri | 01902/10-V |

SERIE PARAOLIO MOTORE

| Descrizione | simile al | Codice |
|--|-----------|----------|
| Storm - Typhoon- Zip Easy Moving 50 | | 11891 |
| Come Sopra (Prezzo Economico) | | 11891/AE |
| Scooter Piaggio Tutti I Mod.Raffreddati A Liquido 498471 | | 12852 |
| Tipo Economico Scooters Piaggio Raffreddati A Liquido | | 12852/AE |
| Hexagon 125-150 Typhoon 125 498451 | | 12855 |

MANICOTTI CARBURATORE

| Descrizione | simile al | Codice |
|---|-----------|--------|
| Runner 50 - Stalker 50 - Storm 50 - Typhoon 50 - Easy Moving 50 | 436095 | 10959 |
| Skipper 125/150 - Typhoon 125 - Runner 125/180 | 430206 | 11977 |

CINGHIE DI TRASMISSIONE

| cm3 | Modello | simile al | Anno Standard | Codice Kevlar | Codice Doppia | Codice |
|-----|--|---------------|---------------|---------------|---------------|--------|
| 50 | DNA/GP Experience (oil pump belt) | 286162 | (00/07) | 11924 | | |
| 50 | DNA/GP Experience 50 | 480852/82712R | (00/05) | 11953 | 11953/K | |
| 50 | Easy moving 50 | 431190/286162 | (95/...) | 11924 | | |
| 50 | Ice 50 | 436864/186162 | (01/...) | 10964 | 10964/K | |
| 50 | Runner 50 dd/sp/lc | 436864 | (97/...) | 10964 | 10964/K | |
| 50 | Runner purejet 50 | 436864/833982 | (02/...) | 10964 | 10964/K | |
| 50 | Runner SP | 436864 | (05/08) | 10964 | 10964/K | |
| 50 | Runner SP Race | 436864 | (06/08) | 10964 | 10964/K | |
| 50 | Runner SP Special Edition | 436864 | (07/08) | 10964 | 10964/K | |
| 50 | Runner/SP/Race/FL/Poggiali/ Purejet/Race/SC (oil pump belt) | 286162 | (97/08) | 11924 | | |
| 50 | Stalker | 436864 | (97/02) | 10964 | 10964/K | |
| 50 | Stalker 50 base | 436864/286162 | (97/04) | 10964 | 10964/K | |
| 50 | Stalker Euro 2/Special Sport | 436864 | (03/08) | 10964 | 10964/K | |
| 50 | Stalker/Euro 2/Special Sport (oil pump belt) | 286162 | (97/08) | 11924 | | |
| 50 | Storm Euro 2 | 436864 | (07/08) | 10964 | 10964/K | |
| 50 | Storm Euro 2 (oil pump belt) | 286162 | (07/08) | 11924 | | |
| 50 | Typhoon X 50 | 430728 | (93/99) | 10996 | 10996/K | |
| 50 | Typhoon/X/XR (oil pump belt) | 286162 | (93/08) | 11924 | | |
| 50 | Typhoon/XR | 436864 | (00/08) | 10964 | 10964/K | |
| 125 | DNA 125 | 487170 | (01/...) | | 11930/K | |
| 125 | DNA 4T | 841213 | (01/...) | | 11930/K | |
| 125 | Nexus Euro 3 | 841213 | (07/08) | | 11930/K | |
| 125 | Runner 125 dd/fx/sp | | (01/...) | | 11928/K | |

CINGHIE DI TRASMISSIONE

| cm3 | Modello | simile al | Anno Standard | Codice Kevlar | Codice Doppia | Codice |
|-----|-------------------------------------|-------------------------|---------------|---------------|---------------|---------|
| 125 | Runner FX/SP 2T | 434812 | (97/02) | | 11928/K | |
| 125 | Runner FX/SP 2T (oil pump belt) | 431370 | (97/02) | | 11928/K | |
| 125 | Runner VX/SC/Race/Euro 3 4T | 841213 | (01/08) | | 11930/K | |
| 125 | Typhoon 125 | 434812/431370 | (95/00) | | 11928/K | |
| 180 | DNA 4T | 827639/832623 840908 | (01/...) | | | 12988/D |
| 180 | DNA 4T 180 | 827639/832623 840908 | (01/...) | | | 12988/D |
| 180 | Runner FXR/SP 2T | 484497 | (97/02) | | 11928/K | |
| 180 | Runner FXR/SP 2T (oil pump belt) | 431370 | (97/02) | | 11928/K | |
| 180 | Runner VXR 4T 180 | 827639/832623 840908 | (01/>) | | | 12988/D |

CINGHIE DI TRASMISSIONE

| cm3 | Modello | simile al | Anno | Codice Standard | Codice Kevlar | Codice Doppia |
|-----|---------------------------|----------------------------|----------|-----------------|---------------|---------------|
| 180 | Tunner 180 dd/sp | | (97/00) | | 11928/K | |
| 180 | VXR 180 4T | 827639/832623 840908200 | | | | 12988/D |
| | Runner 200 | | (02/...) | | 11928/K | |
| 200 | Runner VXR 4T 200 | 840908 | (02/>) | | | 12988/D |
| 200 | Runner VXR 4T/Race/Euro 3 | 840908 | (02/08) | | | 12988/D |
| 200 | VXR 200 4T | 840908 | (02/...) | | | 12988/D |
| 250 | Nexus Euro 3/SP | 843963 | (06/08) | | | 12990/D |
| 500 | Fuoco IE | 832738 | (07/08) | | | 12991/D |
| 500 | Nexus/Euro 3/SP | 832738 | (03/08) | | | 12991/D |
| 800 | GP | 845010 | (08/...) | | 11988/K | |
| 50 | Storm 50 | 286162/430728 | (93/96) | 11924 | | |
| 50 | Typhoon 50 | 430728 | (00/...) | 10996 | 10996/K | |

ARI KITS PARAOLIO FORCELLA

| cm3 | Modello | Anno | Codice | simile | Note |
|-----|--------------------------|-------|---------|--------|------------------|
| 50 | Easy Moving | ————— | ARI.075 | | |
| 50 | Rcr | 2005 | ARI.114 | | |
| 50 | Rcr | 2005 | ARI.115 | | Dust for ARI.114 |
| 50 | Rcr 50 | 2005 | ARI.114 | | |
| 50 | Rcr 50 | 2005 | ARI.115 | | Dust for ARI.114 |
| 50 | Runner 50 Pure Jet | 2005 | ARI.112 | 564236 | |
| 50 | Runner 50 Racing Replica | 2005 | ARI.112 | 564236 | |
| 50 | Runner Sp | 2005 | ARI.112 | 564236 | |
| 50 | Stalker | 2005 | ARI.112 | 564236 | |
| 50 | Storm | ————— | ARI.076 | | |
| 50 | Typhoon | ————— | ARI.076 | 272441 | |
| 50 | Typhoon Benetton | ————— | ARI.076 | 272441 | |
| 50 | Typhoon Martini | ————— | ARI.076 | 272441 | |

ARI KITS PARAOLIO FORCELLA

| cm3 | Modello | Anno | Codice | simile | Note |
|-----|----------------|-------|---------|---------------|------|
| 50 | Typhoon Street | ————— | ARI.076 | 272441 | |
| 80 | Typhoon-Showa- | 98-> | ARI.076 | 272441 | |
| 125 | Runner Fx | ————— | ARI.113 | 564236 | |
| 125 | Runner Sp | ————— | ARI.113 | 564236 | |
| 125 | Runner Vx 125 | 2005 | ARI.051 | 598190 | |
| 125 | Tg2 | 83-84 | ARI.014 | | |
| 125 | Tg3 | 83-84 | ARI.014 | | |
| 125 | Typhoon-Showa- | 98-> | ARI.076 | 272441 | |
| 180 | Runner Fx | ————— | ARI.113 | 564236 | |
| 180 | Runner Sp | ————— | ARI.113 | 564236 | |
| 200 | Runner Vxr 200 | 2005 | ARI.051 | 598190 | |
| 500 | Nexus 500 | 2005 | ARI.102 | 975702/599267 | |

| <i>Articolo</i> | <i>Descrizione</i> | <i>Simile al Nr. Orig.</i> |
|-----------------|--|----------------------------|
| 00659 | Manopola Leva Avviamento - Colore Grigio | 15428 |
| 00687/B | Paio Manopole Ape P401/501/601 | 141925 |
| 01966 | Soffietto Copripolvere Pompa Freni | 76386 |
| 01967 | Copripolvere Pompa Leva Freno 150 Cc. | |
| 02964 | Elemento Elastico Sul Supporto Centrale Modello 150 Cc. | 3480 |
| 02988 | Tampone Elastico Per Forcella Di Attacco Sella Al Telaio | |
| 02992 | Tampone Ammortizzatore Sede Cuscinetti Differenziale | |
| 02993 | Tampone Supporto Motore | |
| 02994 | Tampone Elastico Diam. 29x12,5x17,5 | |
| 03859 | Tampone Di Centraggio Leva Messa In Moto Ape C | |
| 03908/A | Guarnizione Diam.61 X 39 X 3 | 56912 |
| 03967 | Tampone Molleggio Ruota Anteriore | |
| 04904 | Protezione Passaggio Cavo Alta Tensione Ape C | |
| 04980 | Guarnizione Esterna Freni C/4 | |
| 04980/A | Guarnizione Freni Idraulici | 119330 |
| 04993 | Soffietto Carburatore Mp/Car | 133404 |
| 05901/A | (Esaurim) Boccola Leva Avv.350-400 Dal'65-67 500 Dal'66-67 | 76129 |
| 05921 | Cuffia Semiassesse Mp/Car | 198618 |
| 05971 | Giunto Semiassesse Mp/Car | 228302(EX113450) |
| 06920 | Soffietto Pompa Freni Idraulici 350-400-450-500-Mp | 76386 |
| 06943 | Cuffia Semiassesse 50 Cc. Dal '69 - 250 '70/74 | 119989 |
| 06969 | Supporto Attacco Motore Mp-Mpv-Car Dal 78 - P2-P3 Ape 601 | 105976 |
| 07902 | Soffietto Convogliatore Aria Calda | 108827 |
| 08987/A | Raccordo Scatola Depuratore Ape P.602-P.703 | 220403 |
| 09969 | Manicotto Flangiato Per Carburatore Tm/703 | 244787 |
| 11960 | Flangia Carburatore Ape Poker | 288676 |



08987/A



05921



09969



05971



06943



06969



★ 01966



★ 01967



★ 06920



★ 03967



★ 04904



★ 02992



★ 02964



★ 02988



★ 02993



★ 02994



★ 05901/A



★ 04980



★ 03908/A



00687/B

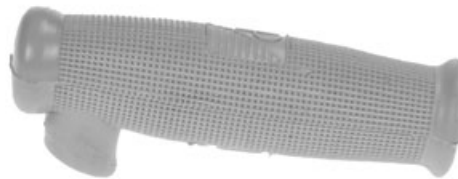

★ 00659



11960



★ 07902



★ 03859



04980/A



04993

TUBETTO BENZINA

| Misura | Descrizione | Confezione | Codice |
|----------|--|------------|------------|
| 5,5 x 10 | Nero | 10 metri | 03904/10 |
| 5,5 x 10 | Verde Trasparente | 10 metri | 03904/10-V |
| 5,5 x 10 | Viola Doppio Strato Per Benzina Senza Piombo | 10 metri | 03904/10-S |
| 6 x 13 | Verde Trasparente | 50 metri | 01902-V |
| 6 x 13 | Nero | 10 metri | 01902/10 |
| 6 x 13 | Verde Trasparente | 10 metri | 01902/10-V |

SERIE PARAOLIO FRENO

| Descrizione | Codice |
|---|--------------------|
| Serie Paraolio Pompa Freni 150/C | Old Model 02854 |
| Serie Paraolio Ceppi Freno 3 ^a Serie | Old Model 04877 |
| Serie Paraolio Ceppi Freno C/4 '62-Ad-Ae-Aeo | Old Model 07876 |
| Serie Paraolio Pompa Centrale Ad/1 175-Mp/Car | 08869 |
| Serie Paraolio Ceppi Freno Ruota Anteriore Mp Diam.20 | Old Model 08894 |
| Serie Paraolio Ceppi Freno Anteriore Mp Diam.22 | 08894/A |
| Serie Paraolio Pompa Freni Ape P 50 - Ape Tm P 50 - FI2 | 09857 |
| Serie Paraolio Ceppi Freno 50 Cc. | 09858 |
| Serie Paraolio Ceppi Freno Cilindretti Post. Mp-Mpv-Mpr-Car | 09891 |
| Serie Paraolio Pompa Centrale Tm/602-Tm/703 | 11870 |
| Serie Paraolio Ceppi Freno Ant. E Post. Tm P/602-Tm P/703 | 11871 |
| Serie Guarnizioni Ceppi Freno Post. Ape 50 -Tm - P50/FI2 | orig. 154797 11893 |

SERIE PARAOLIO MOTORE

| Descrizione | Codice |
|----------------------------------|-----------------|
| 175-Mp-Mpr-Mpn-Mpv-Car-P400-P601 | 08878 |
| P 602 Tm-P 703 Tm | 10895 |
| P 601 Ls-Car Ls2 P2 Solo Motore | 11858 |
| P.501 - P.601 Ii Serie Dal 1985 | Old Model 11886 |

PARAOLIO SINGOLI**APE 50**

| Misura | Descrizione | simile al | Codice |
|--------------|----------------------------|----------------|--------|
| SC 32 19 7 | Per Albero Motore | S/8720 - 15579 | P/089 |
| SC 40 28 7 | Per Semiassi | 116205 | P/155 |
| SC 42 27 10 | Per Mozzo Ruota Posteriore | 118058 | P/170 |
| SC 42 32 7 | Per Sospensione Anteriore | 3/21460 | P/174 |
| SC 47 22,7 7 | Per Albero Motore | S/8731 | P/189 |

PARAOILIO SINGOLI**APE 400**

| Misura | Descrizione | simile al | Codice |
|----------------|---------------------|------------------|---------------|
| SC 28 17 7 | Per Albero Motore | S/8720 - 15579 | P/089 |
| SC 45 24,9 6,5 | Per Albero Motore | 78002 | P/178 |
| SC 47 20 8 | Per Ruota Anteriore | 2/93343 | P/186 |
| SC 47 28 7 | Per Cambio | S/7337 | P/194 |
| SC 52 32 5 | Per Albero Motore | S/8733 | P/220 |
| SC 62 32 6 | Per Albero Motore | S/127891- S/8734 | P/257 |

APE MP - MPR - MPM - MPV - CAR - P400/601

| Misura | Descrizione | simile al | Codice |
|----------------|---------------------------------------|------------------|---------------|
| SC 18 10 4 | Per Albero Camma Ruttore | 152351 | P/006 |
| SC 32 22 7 | Per Semiassa | S/7276 | P/096 |
| SC 45 24,9 6,5 | Per Albero Motore Lato Volano Esterno | 78002 | P/178 |
| SC 47 35 7 | Per Trasmissione | 2/20359 | P/201 |
| TC 50 33 6 | Per Crociera Trasmissione | S/17014 | P/208 |
| SC 52 32 5 | Per Albero Motore Lato Volano Interno | 77976 | P/220 |
| SC 62 32 6 | Per Albero Motore Lato Frizione | 2/27891-S/8726 | P/257 |

APE CAR LD - P601 LS - P2

| Misura | Descrizione | simile al | Codice |
|-----------------------|---------------------------------------|------------------|---------------|
| HSCRY 45 24,9 6,5/5,5 | Per Albero Motore | 145597 | P/179 |
| SC 52 32 5 | Per Albero Motore Lato Volano Interno | 77976 | P/220 |
| SC 62 32 6 | Per Albero Motore Lato Frizione | 2/27891-S/8726 | P/257 |

| <i>Articolo</i> | <i>Descrizione</i> | <i>Simile al Nr. Orig.</i> |
|-----------------|--|----------------------------|
| 01584 | Coprileva Cambio Lungh.40 Foro Passante Diam.8 | |
| 01590 | Coprileva Avviamento Yamaha | |
| 01663/SSF | Paio Manopole | |
| 01681/SSF | Paio Manopole | 4FM2624000/4FM2624100 |
| 01694/SSF | Paio Manopole R1 - Majesty | |
| 02519 | Copripedale Passeggero | 1202743300 |
| 02626/SSF | Paio Manopole Dal 2009 | |
| 07907 | Paio Soffietti Dt 125 | 2A62319100 |
| 09913 | Paio Soffietti DT 50 MX - Nero (Anni '80) | |
| 09968 | Manicotto Carburatore Yamaha Rd 250-350 | 2R9-13565-01 |
| 09990 | Paio Soffietti Supertenere' Nero | |
| 10954 | Paio Soffietti Yamaha Scooter - MbK - Booster Fino Al 1994 | |



01590



01663/SSF



01681/SSF



01694/SSF



02626/SSF



02519



09968



10954



01584



09913



09990



07907

| <i>Articolo</i> | <i>Descrizione</i> | <i>Simile al Nr. Orig.</i> |
|-----------------|--|----------------------------|
| 02502 | Appoggiapiede Zundapp Ks 50 | 43314119 |
| 02516 | Coprileva Cambio Mod. 1980 | |
| 06908 | Soffietto Protez. Catena | 51714154 |
| 06913 | Soffietto Conico Forcella - KS50 - KS80 - GTS50 - Diam.33/45 - Lungh.220 | 51812100 |
| 06927 | Manicotto Zundapp | 26604139 |
| 06928 | Manicotto Carburatore | |
| 06929 | Manicotto Carburatore | 26704139/12 |
| 06930 | Manicotto Carburatore | 28304102 |
| 06937 | Manicotto Carburatore | |
| 08907 | Manicotto Carburatore Cs | 27804112 |
| 08908 | Manicotto Carburatore Gts-Ks | 28004106 |
| 08915 | Soffietto Forcella Sprinter | 44812106 |
| 08923 | Manicotto Marmitta | 44622107 |
| 08925 | Cono Scatola Filtro | 51710109 |
| 08926 | Cono Scatola Filtro | 52910137 |
| 08944 | Tampone | 51718109 |
| 08945 | Boccola | 52918107 |
| 08947 | Manicotto Carburatore | 27804136 |
| 08948 | Manicotto Carburatore Diam.27/32 Sprinter | 28004114 |
| 08950 | Manicotto Diam.32/34 Hai 50 Cc. | 44822118 |
| 08952 | Manicotto Carburatore Diam.28 125 Cc.Ks | 28504209 |
| 08957 | Tassello Serbatoio | |



06913



☆ 06908



☆ 08915



☆ 06927



☆ 06928



☆ 06929



☆ 06930



☆ 06937



☆ 08952



☆ 08948



☆ 08947



☆ 08908



☆ 08907



☆ 08926



☆ 08925



☆ 08957



☆ 02516



☆ 02502



☆ 08950



☆ 08923



☆ 08945



☆ 08944

| <i>Articolo</i> | <i>Descrizione</i> | <i>Simile al Nr. Orig.</i> |
|-----------------|--|----------------------------|
| 00697 | Paio Manopole Ciclomotore Diam. 22-24 | SX 44417903 - DX 51017912 |
| 01597 | Coprileva Cambio Lungh.54 Foro Cieco Diam.8 | 616225 |
| 01602 | Paio Manopole Comando Magura Diam. 22-24 Mm | |
| 01609/A | Paio Manopole Comando Magura Diam. 22-24 Mm | SX 53017107 - DX 53017915 |
| 01611 | Paio Manopole Comando Magura Diam. 22-24 Mm - Moped | SX 52917113 - DX 52917902 |
| 03906 | Boccola | 44816105 |
| 03966 | Tamponcino | 26601217 |
| 04990 | Calotta Forcella Diam 30 | 51712167 |
| 06902 | Tendicavo Comando Gas Magura | |
| 08921 | Boccola Diam.20 X 11 X 11,6 | 43315112 |
| 08922 | Boccola Parastrappi Diam.29 X 18 X 11,5 Per Mozzo Diam.150 | 51715112 |
| 08924 | Tappo | 51716239 |
| 08927 | Tappo Ispezione | 43214117 |
| 08932 | Passacavo Grigio Scuro | 43212120 |
| 08946 | Tampone Pedale Cambio | 26705130 |

MANOPOLE STANDARD

| <i>Articolo</i> | <i>Descrizione</i> | <i>Simile al Nr. Orig.</i> |
|-----------------|--|----------------------------|
| 00623/24 | Paio Manopole Ciclomotore Lungh. 100 Mm | |
| 00623/24/GR | Paio Manopole Lung. 100 Mm - Grigio | |
| 00693 | Paio Manopole Diam.22-24 Gomma Nera Modello Doherty | |
| 01602 | Paio Manopole Gomma | |
| 01617/A | Paio Manopole Tommaselli Daytona Anni 70-80 Colore Nero | |
| 01617/A-P | Paio Manopole Tommaselli Daytona Anni 70-80 Colore Para | |
| 01617/A-R | Paio Manopole Tommaselli Daytona Anni 70-80 Colore Rosso | |
| 01623 | Paio Manopole Asp Nero | |



01609/A
☆ 01611



☆ 00697



☆ 01602



☆ 04990



☆ 06902



01597

MANOPOLE STANDARD



☆ 00623/24



☆ 00623/24/GR



01617/A
☆ 01617/A-P
01617/A-R



☆ 01602



☆ 00693



01623

| <i>Articolo</i> | <i>Descrizione</i> | <i>Simile al Nr. Orig.</i> |
|-----------------|---|----------------------------|
| 00670/24 | Manopola Industriale Per Tubo Diam. 24 - Lungh. Mm 125 | |
| 00670/27 | Manopola Industriale Per Tubo Diam. 27 - Lungh. Mm 125 | |
| 00687/21 | Manopola Industriale Per Tubo Diam. 21 Lungh. 125 - Colore Nero | |
| 00687/22 | Manopola Industriale Per Tubo Diam. 22 Lungh. 130 - Colore Nero | |
| 00687/24 | Manopola Industriale Per Tubo Diam. 24 Lungh. 130 - Colore Nero | |
| 00687/27 | Manopola Industriale Per Tubo Diam. 27 Lungh. 125 - Colore Nero | |
| 00698/28 | Manopola Industriale Per Tubo Diam.28 - Lungh. Mm 120 - Colore Nero | |
| 00698/30 | Manopola Industriale Per Tubo Diam.30 - Lungh. Mm 120 - Colore Nero | |
| 00698/32 | Manopola Industriale Per Tubo Diam.32 - Lungh. Mm 120 - Colore Nero | |
| 01609/A | Paio Manopole Asp Magura Per Moto - Diam. 22-24 | |
| 01611 | Paio Manopole Asp Magura Per Ciclomotore Diam. 22-24 | |
| 01626/22 | Manopola Industriale Per Tubo Diam. 22 Lungh. 135 - Colore Nero | |
| 01626/24 | Manopola Industriale Per Tubo Diam. 24 Lungh. 135 - Colore Nero | |
| 01635/24 | Manopola Industriale Per Tubo Diam. 24 Lungh. 120 - Colore Nero | |
| 01635/26 | Manopola Industriale Per Tubo Diam. 26 Lungh. 120 - Colore Nero | |
| 01635/28 | Manopola Industriale Per Tubo Diam. 28 Lungh. 120 - Colore Nero | |
| 01646 | Paio Manopole Mountain Bike Per Tubo Diam. 22 - Lungh. Mm 122 | |
| 01649 | Paio Manopole Mountain Bike Per Tubo Diam. 22 - Lungh. Mm 123 | |
| 01656 | Paio Manopole Lamellari Nere Per Tubo Diam. 22 - Lungh. Mm 110 - Per Bicicletta | |
| 01656/18 | Paio Manopole Lamellari Nere Per Tubo Diam. 18 - Lungh. Mm 110 | |
| 01683/22 | Manopola Diam.22 - Lungh. Mm 125 | |
| 01683/24 | Manopola Diam.24 - Lungh. Mm 125 | |



☆ 01611



01609/A



01683/22
01683/24



01626/22
01626/24



00670/24
00670/27



00687/21
00687/22
00687/24
00687/27



01635/24
01635/26
01635/28



00698/28
00698/30
00698/32



01656
01656/18

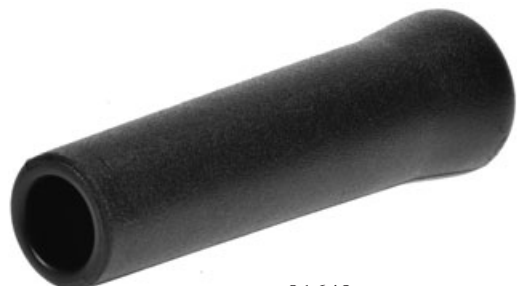

01649
01646

| <i>Articolo</i> | <i>Descrizione</i> | <i>Simile al Nr. Orig.</i> |
|-----------------|--|----------------------------|
| 00508 | Copripedale Guidatore Lungh. Mm 120 Foro Cieco Diam.14 | |
| 00511 | Copripedale Guidatore Lungh. Mm. 110 Foro Cieco Diam. 26 | |
| 00549 | Copripedale Lungh. Mm. 125 Foro Cieco Diam. 15 | |
| 00571 | Copripedale Guidatore Lungh. Mm. 125 Foro Cieco Diam. 18 | |
| 01517 | Copripedale Guidatore Lungh.110 Foro Cieco Diam.12-14-16 | |
| 01543/A | Copripedale Guidatore Lungh.104 Foro Cieco Diam.14 | |
| 01571 | Copripedale Guidatore Lungh.112 Mm. Foro Cieco Diam.12-14-16 | |
| 01572 | Copripedale Guidatore Lungh.81 Foro Cieco Diam.17 | |
| 01580 | Copripedale Guidatore Lungh.115 Foro Cieco Diam.12 | |
| 01580/A | Copripedale Guidatore Lungh.105 Foro Cieco Diam.12 | |
| 01591/B | Copripedale Guidatore Lungh.94 Foro Cieco Diam. 14 | |
| 01593 | Copripedale Guidatore Lungh.110 Foro Cieco Diam.14 | |
| 02515 | Copripedale Guidatore Foro Cieco Diam.16 Lungh.107 | |
| 02515/A | Copripedale Guidatore Foro Cieco Diam.18 Lungh.107 | |
| 02526/A | Copripedale Guidatore Foro Cieco Diam.14 Lungh.85 | |
| 02529 | Copripedale Guidatore Foro Cieco Diam.21 Lungh. 100 | |
| 02540 | Copripedale Guidatore Lungh.94 Foro Cieco Diam. 14 | |
| 02540/A | Copripedale Guidatore Lungh.94 Foro Cieco Diam. 16 | |



★ 00508



★ 00511



01543/A



★ 00571



★ 01517



★ 00549



★ 01571



01572



★ 01580/A



★ 01580



01591/B
02540
02540/A



01593



★ 02515
02515/A
02529



02526/A

| <i>Articolo</i> | <i>Descrizione</i> | <i>Simile al Nr. Orig.</i> |
|-----------------|---|----------------------------|
| 00502 | Copripedale Passeggero | |
| 00510 | Coprileva Cambio | |
| 00554 | Copripedale Passeggero | |
| 00554/B | Copripedale Passeggero Foro Passante Diam. 17 Mm | |
| 00556 | Coprileva Cambio-Freno Diam. 12 L=79 Mm | |
| 00557 | Coprileva Avviamento Diam. Int. 13 - Lungh. 75 Mm | |
| 00597 | Coprileva Cambio | |
| 00598 | Coprileva Avviamento | |
| 01507 | Coprileva Avviamento Lungh.70 Foro Passante Diam.12 | |
| 01507/A | Coprileva Avviamento Lungh.70 Foro Passante Diam.14 | |
| 01507/B | Coprileva Avviamento Lungh.70 Foro Passante Diam.11 | |
| 01512 | Coprileva Cambio Lungh.40 Foro Cieco Diam.9 | |
| 01514 | Coprileva Cambio Foro Cieco Rettangolare 21x14 - Lungh.55 | |
| 01532 | Coprileva Lungh.40 Foro Cieco Diam.10 | |
| 01535 | Coprileva Cambio Lungh.46 Foro Passante Diam.10 | |
| 01535/A | Coprileva Cambio Lungh.46 Foro Passante Diam.13 | |
| 01567 | Coprileva Avviamento Lungh.65 Foro Cieco Diam.12 | |
| 01570 | Coprileva Avviamento Lungh.53 Foro Cieco Diam.14 | |
| 01596/A | Coprileva Avviamento Lungh.52 Foro Passante Diam.10 | |
| 02501 | Coprileva Cambio Foro Passante Diam.7,5 Lungh.30 | |
| 02501/A | Coprileva Avviamento | |
| 02513 | Coprileva Foro Cieco Diam.12 Lungh.54 | |
| 02514 | Coprileva Cambio Foro Passante Ovale 10 X 6 Lungh.44 | |
| 02517 | Coprileva Foro Passante Diam.9,5 Lungh.70 | |



00502



★ 00554
00554/B



00557



02517



00556



01507
01507/A
01507/B



01535
01535/A



02514



00510

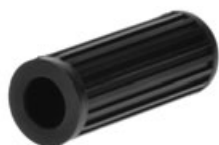

01567



★ 02513



01570



00598



01596/A



00597



01532



01512



02501/A



02501



01514

| <i>Articolo</i> | <i>Descrizione</i> | <i>Simile al Nr. Orig.</i> |
|-----------------|--|----------------------------|
| 01961 | Soffietto Forcella Diam.30/32 9 Spire Lungh.135 | |
| 01961/A | Soffietto Forcella Diam.27/33 Lungh.175 | |
| 01970 | Soffietto Forcella Diam.22/28 8 Spire Lungh.1110 | |
| 02966 | Soffietto Forcella Diam.23/35 8 Spire Lungh.145 | |
| 04905 | Soffietto Forcella Diam.48/48 15 Spire Lungh.190 | |
| 04983 | Soffietto Forcella Diam.50/55 23 Spire Lungh.230 | |
| 05954 | Soffietto Forcella Diam.50/55 Lungh.215 | |
| 05955 | Soffietto Forcella Diam.30/40 Lungh.150 | |
| 05956 | Soffietto Forcella Diam.50/50 Lungh.150 | |



01961/A



☆ 01961



02966



☆ 01970



☆ 05954



☆ 04905



☆ 05956



04983



☆ 05955

| <i>Articolo</i> | <i>Descrizione</i> | <i>Simile al Nr. Orig.</i> |
|-----------------|---|----------------------------|
| 06970 | Paio Soffietti Diam. 31/51 Lungh. 340 | |
| 07901 | Paio Soffietti Diam. 35/55 Lungh. 350 | |
| 08904 | Soffietto Forcella Diam.35/58 Lungh.290 | |
| 09932 | Paio Soffietti Diam. 40/57 Lungh. 355 | |

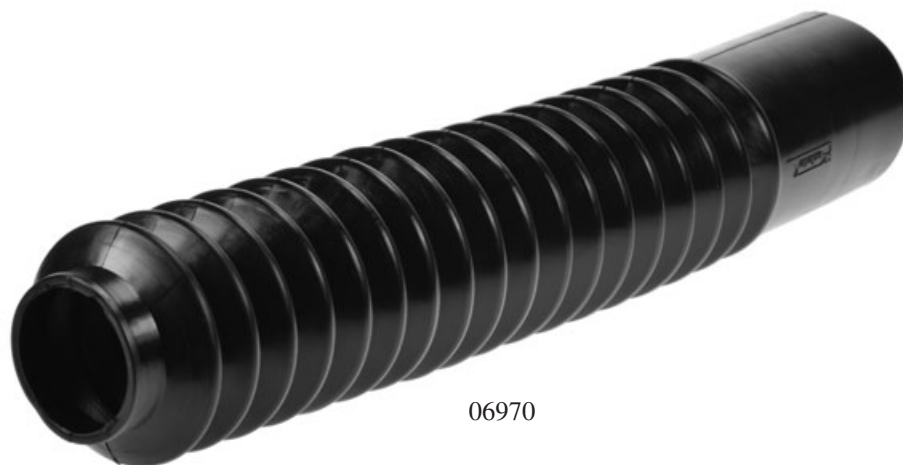

06970

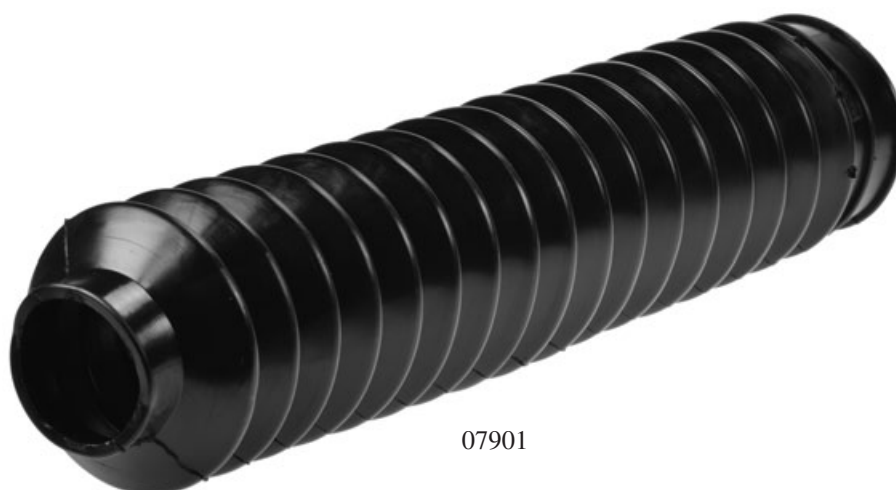

07901



08904

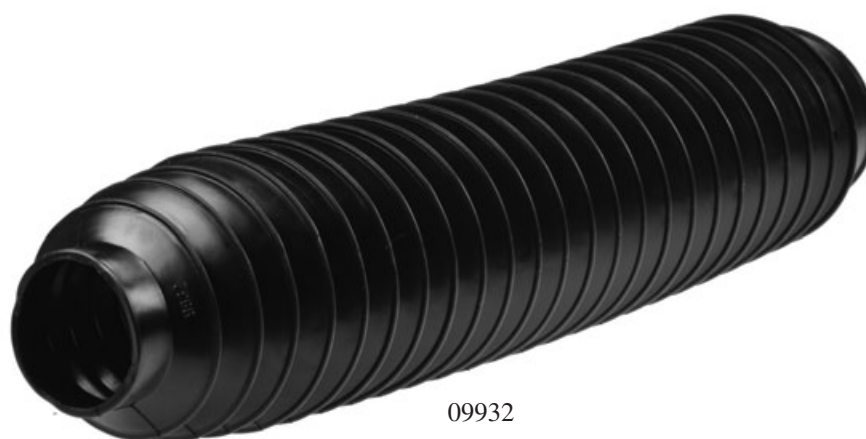

09932

| <i>Articolo</i> | <i>Descrizione</i> | <i>Simile al Nr. Orig.</i> |
|-----------------|---------------------------------------|----------------------------|
| 07995 | Paio Soffietti Diam. 38/58 Lungh. 350 | |
| 09942/A | Paio Soffietti Diam. 33/53 Lungh. 335 | |
| 09943 | Paio Soffietti Diam. 38/58 Lungh. 360 | |
| 09950 | Paio Soffietti Diam. 43/80 Lungh. 380 | |



09942/A



09943

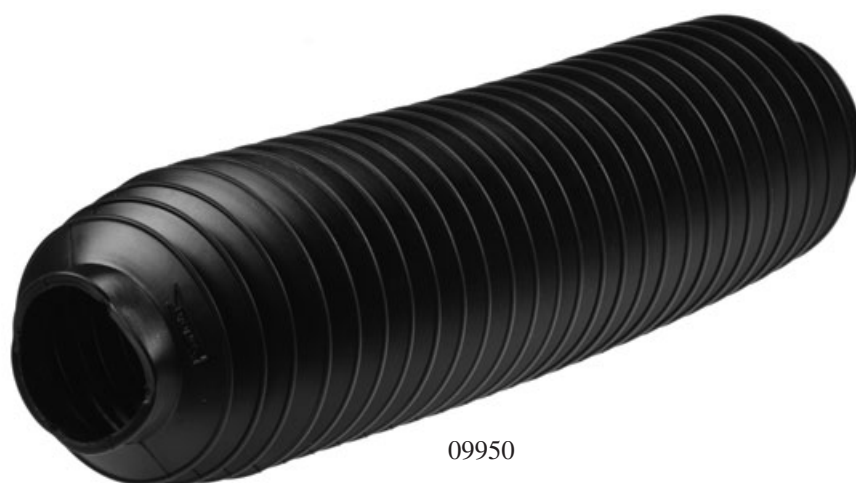

09950



07995

| <i>Articolo</i> | <i>Descrizione</i> | <i>Simile al Nr. Orig.</i> |
|-----------------|--|----------------------------|
| 04914 | Soffietto Forcella Diam.39/42 20 Spire Lungh.215 | |
| 04982 | Soffietto Forcella Speedway Diam.22/26 5 Spire Lungh.160 | |
| 06962 | Paio Soffietti Diam. 31/51 Lungh. 245 | |
| 06981 | Soffietto Forcella Diam.27/41 Lungh.240 15 Spire | |
| 09927 | Paio Soffietti Diam. 29/45 Lungh. 215 | |
| 09941 | Paio Soffietti Diam. 30/52 Lungh. 245 | |



09941



09927



06962



06981



04914



★ 04982

| <i>Articolo</i> | <i>Descrizione</i> | <i>Simile al Nr. Orig.</i> |
|-----------------|--------------------------------------|----------------------------|
| 03988 | Cinghietta Per Batteria Lungh.280 | |
| 05949 | Elastico Per Serbatoio Lungh.250 | |
| 05949/A | Elastico Per Serbatoio Lungh.210 | |
| 05992 | Cinghia Elastica Lungh.150 | |
| 06958 | Anello Elastico Piccolo | |
| 06958/A | Anello Elastico Grande | |
| 06984 | Cinghia Per Batteria Lungh.115 | |
| 06985 | Cinghia Per Batteria Lungh. 110 | |
| 06986 | Tirantino Lungh.140 | |
| 06987 | Tirantino Con Occhielli Lungh.100 | |
| 08928 | Tirante Serbatoio Lungh. 88 | |
| 08930 | Tirante Serbatoio Lungh. 210 | |
| 09912 | Tirantino Per Portaforo Tipo Acerbis | |



03988



09912



05949



05949/A



05992



06984



06958/A



06958



08928



06986



06987



08930



06985

| <i>Articolo</i> | <i>Descrizione</i> | <i>Simile al Nr. Orig.</i> |
|-----------------|---|----------------------------|
| 04999 | Cappuccio Candela In Silicone Rosso Attacco Piccolo Diam. 3,9 Mm | |
| 04999/A | Cappuccio Candela In Silicone Attacco Grande Diam. 6,3 Mm | |
| 04999/P | Cappuccio Candela In Neoprene Attacco Grande Diam. 6,3 Mm | |
| 09965 | Cappuccio Candela Rosso In Silicone Attacco Per Nottolino Diam. 6,3 Mm | |
| 09965/A | Cappuccio Candela Nero In Silicone Attacco Per Nottolino Diam. 6,3 Mm | |
| 09965-A | Cappuccio Candela Blu In Silicone Attacco Per Nottolino Diam. 6,3 Mm | |
| 04999/C | Cappuccio Candela In Silicone Attacco Piccolo Diam. 3,9 Mm | |
| 04999/L | Cappuccio Candela In Silicone Attacco Piccolo Diam. 3,9 Mm | |
| 12949 | Cappuccio Candela In Gomma Epdm - Resistore Ceramico 5k Ohm - Attacco Grande Diam. 6,3 Mm | |
| 12949/S | Cappuccio Candela In Silicone - Resistore Ceramico 5k Ohm - Attacco Grande Diam. 6,3 Mm | |

GUIDA CATENA

| <i>Articolo</i> | <i>Descrizione</i> | <i>Simile al Nr. Orig.</i> |
|-----------------|---------------------|----------------------------|
| 06945 | Guidacatena | |
| 06945/A | Pattino Guidacatena | |
| 10908 | Tendicatena Trial | |

SILENT BLOCK



| <i>Tipo A</i> | <i>Ø Esterno</i> | <i>H. Gomma</i> | <i>Filetto</i> | <i>H.Filetto</i> |
|---------------|------------------|-----------------|----------------|------------------|
| 06963 | 30 | 20 | MM8 | 13 |
| 06969 | 40 | 34 | MM10 | 20 |
| 08986 | 25 | 20 | MM6 | 12 |
| 09936 | 30 | 15 | MM8 | 18 |
| 09937 | 25 | 12 | MM8 | 18 |
| 10922 | 15 | 15 | MM4 | 11 |
| 10924 | 20 | 15 | MM6 | 14 |



GUIDA CATENA



06945



06945/A



10908

SILENT BLOCK



| <i>Tipo B</i> | <i>Ø Esterno</i> | <i>H. Gomma</i> | <i>Filetto</i> | <i>H.Filetto</i> |
|---------------|------------------|-----------------|----------------|------------------|
| 06963/A | 30 | 20 | M8F8 | 12 |
| 08986/A | 25 | 20 | M8F8 | 12 |
| 09961 | 25 | 20 | M8F8 | 12 |
| 10918 | 20 | 20 | M8F6 | 13 |
| 10919 | 25 | 15 | M6F6 | 12 |
| 10923 | 20 | 20 | M6F6 | 12 |



00902/A



00902



00921



00922



00923/A



00923



00925



★ 07967



07938



07957/A

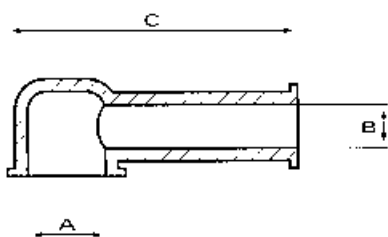

Articolo

A

B

C

00902 25 8 87

00902/A 27 7,5 77

00921 10 6 40

00922 15 7 44

00923 15 10 62

00923/A 17 8 65

00925 17 5 43

02986 18 8,5 56

07938 19 12 73

07957/A 17 7 45



☆ 00409/10

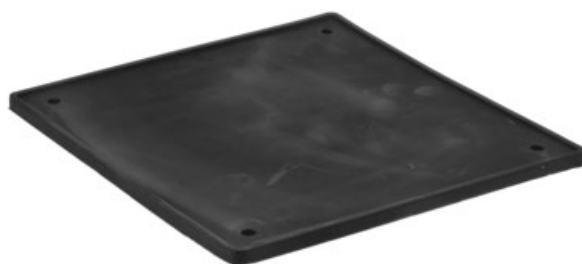

05951/A



☆ 05953



09972



05951



10938



08998

| <i>Articolo</i> | <i>Descrizione</i> | <i>Simile al Nr. Orig.</i> |
|-----------------|--|----------------------------|
| 00409/10 | Paio Ginocchiere Dx - Sx | |
| 05951 | Portatarga In Gomma Con Supporto Fanalino | |
| 05951/A | Portatarga In Gomma | |
| 05953 | Soffietтино Protezione Carburatore Diam. 47 Mm. | |
| 08998 | Sostegno Bombolette Ammortizzatori | |
| 09972 | Tampone Appoggio Serbatoio Su Telaio Quadro Deltabox | |
| 10938 | Portatarga Ciclomotori Italiani | |

| <i>Articolo</i> | <i>Descrizione</i> | <i>Simile al Nr. Orig.</i> |
|-----------------|--|----------------------------|
| 00908 | Cappuccio Diam. 6/14 - Lungh. 25 | |
| 00926 | Passacavo Diam. Int. 3, Gola 6, Est. 9, Altezza Gola 1, Altezza Totale 7 | |
| 00928 | Passacavo Diam. Int. 8, Gola 11, Est. 16, Altezza Gola 1, Altezza Totale 6,5 | |
| 00929 | Passacavo Diam. Int. 8, Gola 12, Est. 16, Altezza Gola 1, Altezza Totale 8 | |
| 02910 | Boccola Ammortizzatore Diam. 26x12 - Altezza 10 | |
| 03901 | Boccola Ammortizzatore Diam. 33x12 - Altezza 13 | |
| 03901/B | Boccola Ammortizzatore Diam. 13x23 - Altezza 13 | |
| 03903 | Boccola Ammortizzatore Diam. 22x10 - Altezza 9,5 | |
| 03989 | Boccola Ammortizzatore Diam. 23x12 - Altezza 8 | |
| 04913/A | Soffietto Cavi Comandi - Base Diam. 16 mm. | |
| 05933/A | Soffietto Cavi Comandi Diam. 6/9 - Lungh. 27 | |
| 06901 | Raccordo Carburatore Scatola Filtro Diam. 40/57 - Lungh. 55 - CZ Anni 70/80 | |
| 06916 | Cappuccio Diam. 5/12 - Lungh. 30 (Sachs) | |
| 06960 | Manicotto Carburatore Flangiato Sachs - Carburatore da 30 mm. | |
| 06973 | Paraspruzzi Parafango Anteriore | |
| 07994 | Paio Coprileva Freno-Frizione al Manubrio | |
| 08967 | Soffietto Copricavo Comandi KTM - Diam. 1/7 - Lungh. 57 (Base Cava) | 5102092051 |
| 08967/A | Soffietto Copricavo Comandi KTM - Diam. 1/7 - Lungh. 57 (Base Piena) | 121199000 |
| 09967 | Soffietto Cavi Diam. 1/6 - Lungh. 75 (Peugeot) | |
| 10927 | Cappuccio Diam. 6/13 - Lungh. 20 | |
| 10933 | Raccordo Cablaggi a 3 Vie - Diam. 10 | |
| 13906 | Kimco - Tampone Battuta Cavalletto Centrale - Tutti i Modelli | |



04913/A



06916



10927



00908



05933/A



10933



09967



08967
08967/A



13906



★ 02910



★ 03989



00926



00928



00929



★ 03903



03901/B



★ 03901



★ 06960



★ 07994



06973



★ 06901

| <i>Articolo</i> | <i>Descrizione</i> | <i>Simile al Nr. Orig.</i> |
|-----------------|---|----------------------------|
| 00914/A | Manicotto Tubo Scarico Diam.32,5/34,5 Lungh.44 | |
| 00914/B | Manicotto Tubo Scarico Diam.34/36 Lungh.44 | |
| 00914/C | Manicotto Tubo Scarico Diam.23/24,5 Lungh.45 | |
| 00914/D | Manicotto Tubo Scarico Diam.19,5/22 Lungh.45 | |
| 05916 | Manicotto Tubo Scarico Diam.26/28 Lungh.44 | |
| 05916/A | Manicotto Tubo Scarico Diam.29/31 Lungh.44 | |
| 05916/B | Manicotto Tubo Scarico Diam.40/41 Lungh.44 | |
| 05916/C | Manicotto Tubo Scarico Diam.23/27 Lungh.44 | |
| 06974 | Manicotto Tubo Scarico Diam.17/19 Lungh.45 | |
| 06975 | Manicotto Tubo Scarico Diam.21,5/24,5 Lungh.45 | |
| 08923 | Manicotto Tubo Scarico Diam 22/26 Lungh. 49 | |
| 08923/A | Manicotto Tubo Scarico Diam.20/22 Lungh. 40 | |
| 08923/B | Manicotto Tubo Scarico Diam.25/27 Lungh.25 | |
| 08950 | Manicotto Tubo Scarico Diam 32/34 Lungh. 45 | |
| 09966 | Manicotto Tubo Scarico Diam.24/28 Lungh.44 | |
| 09992 | Manicotto Tubo Scarico Diam 21/27 Lungh. 45 | |
| 10901 | Tappo Tubo Scarico Per Lavaggio - Da Diam 19 A 38 | |
| 13904 | Tappo Tubo Scarico Per Lavaggio - Da Diam 24 A 49 | |



00914/A



00914/B



00914/C



00914/D



05916



05916/A



05916/B



05916/C



06975



06974



★ 08923



★ 08950



09992



09966



08923/A



★ 08923/B



10901



13904

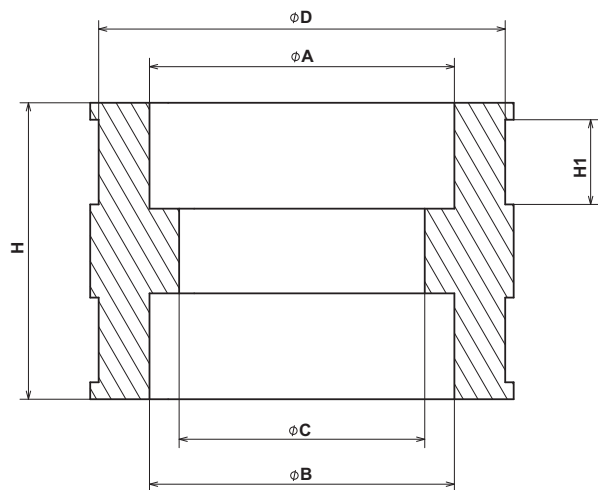

| <i>Codice</i> | <i>A</i> | <i>B</i> | <i>C</i> | <i>D</i> | <i>H</i> | <i>H1</i> | <i>Materiale</i> | <i>Shore A</i> |
|---------------|----------|----------|----------|----------|----------|-----------|------------------|----------------|
| ★ 06930 | 24,5 | 24,5 | 21 | 34 | 30 | 10 | NBR/PVC | 65 |
| ★ 06937 | 36 | 34 | 29 | 48 | 35 | 10 | NBR/PVC | 65 |
| 06954 | 43 | 43 | 36 | 53 | 35 | 9 | NBR/PVC | 65 |

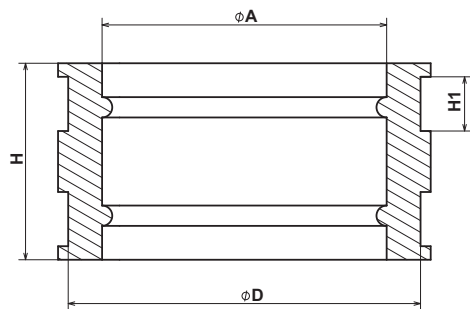

| <i>Codice</i> | <i>A</i> | <i>B</i> | <i>C</i> | <i>D</i> | <i>H</i> | <i>H1</i> | <i>Materiale</i> | <i>Shore A</i> |
|---------------|----------|----------|----------|----------|----------|-----------|------------------|----------------|
| 06936 | 42 | - | - | 52 | 29 | 8 | NBR/PVC | 65 |

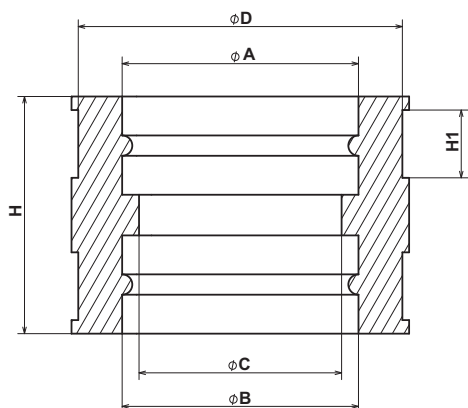

| <i>Codice</i> | <i>A</i> | <i>B</i> | <i>C</i> | <i>D</i> | <i>H</i> | <i>H1</i> | <i>Materiale</i> | <i>Shore A</i> |
|---------------|----------|----------|----------|----------|----------|-----------|------------------|----------------|
| 06937/A | 35 | 35 | 30 | 48 | 35 | 10 | NBR/PVC | 65 |
| 06954/A | 44 | 44 | 36 | 55 | 33 | 12 | NBR/PVC | 65 |
| 06956 | 42 | 42 | 37 | 53 | 29 | 8 | NBR/PVC | 65 |
| 08906 | 49 | 49 | 41 | 59 | 35 | 13 | NBR/PVC | 65 |
| 08906/A | 44 | 44 | 40 | 59 | 35 | 13 | NBR/PVC | 65 |
| 08906/B | 44 | 44 | 34 | 59 | 35 | 13 | NBR/PVC | 65 |
| 08910 | 34 | 34 | 32 | 45 | 30 | 9 | NBR/PVC | 65 |
| 08911 | 34 | 30 | 27 | 45 | 30 | 9 | NBR/PVC | 65 |
| ★ 08952 | 33 | 33 | 28 | 48 | 40 | 10 | NBR/PVC | 65 |
| 08991 | 38 | 42 | 36 | 54 | 34 | 10 | NBR/PVC | 65 |
| 09998 | 34 | 34 | 28 | 44 | 34 | 12 | NBR/PVC | 65 |
| 09991 | 39 | 39 | 34 | 49 | 34 | 12 | NBR/PVC | 65 |
| 09999 | 42 | 42 | 39 | 55 | 34 | 12 | NBR/PVC | 65 |
| 10947 | 30 | 30 | 26 | 44 | 37 | 13 | NBR/PVC | 65 |
| 10948 | 26 | 23 | 21 | 44 | 37 | 13 | NBR/PVC | 65 |



12935

| <i>Articolo</i> | <i>Descrizione</i> | <i>Simile al Nr. Orig.</i> |
|-----------------|---|----------------------------|
| 12935 | Manicotto Carburatore Flangiato Dell'Orto PHBG 18-BS per Kart | |

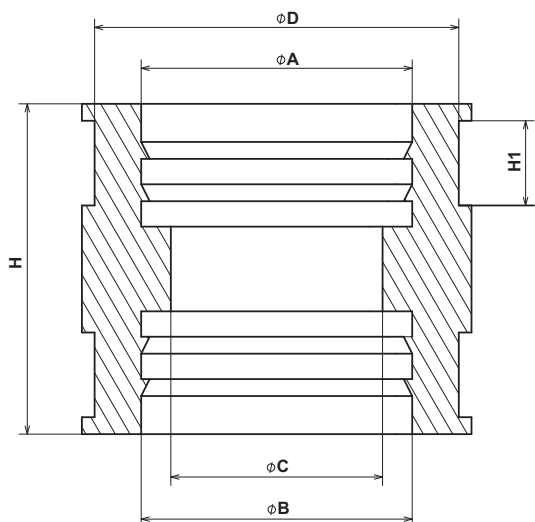

| <i>Codice</i> | <i>A</i> | <i>B</i> | <i>C</i> | <i>D</i> | <i>H</i> | <i>H1</i> | <i>Materiale</i> | <i>Shore A</i> |
|---------------|----------|----------|----------|----------|----------|-----------|------------------|----------------|
| 06952 | 32 | 32 | 25 | 43 | 39 | 10 | NBR/PVC | 65 |
| 06952/A | 32 | 32 | 27 | 42,5 | 39 | 10 | NBR/PVC | 65 |
| 06952/C | 33 | 33 | 27,5 | 43,5 | 29 | 8 | NBR/PVC | 65 |
| 06955 | 43,5 | 43,5 | 30 | 59 | 38 | 10 | NBR/PVC | 65 |
| 06955/A | 43,5 | 43,5 | 34 | 59 | 38 | 10 | NBR/PVC | 65 |
| 06955/B | 43,5 | 43,5 | 36 | 59 | 38 | 10 | NBR/PVC | 65 |
| 06955/D | 40 | 44 | 30 | 54 | 39 | 10 | NBR/PVC | 65 |



11903



11903/A

| <i>Articolo</i> | <i>Descrizione</i> | <i>Simile al Nr. Orig.</i> |
|-----------------|--|----------------------------|
| 11903 | Manicotto Speedway Diam. 34,5 per Motore GM e Jawa | |
| 11903/A | Manicotto Speedway Diam. 37 per Motore GM e Jawa | |

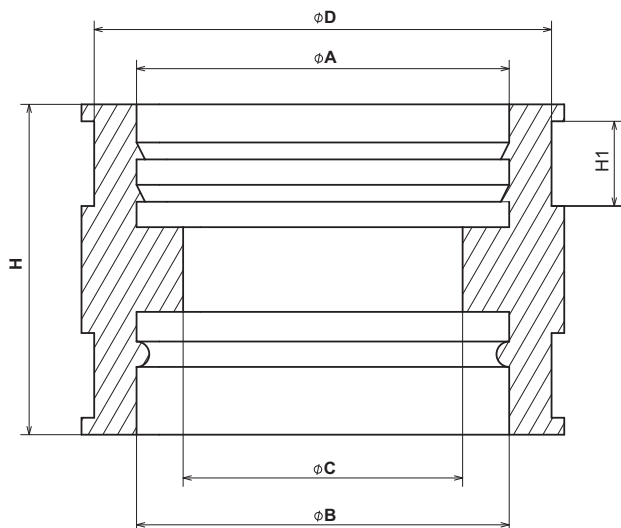

| <i>Codice</i> | <i>A</i> | <i>B</i> | <i>C</i> | <i>D</i> | <i>H</i> | <i>H1</i> | <i>Materiale</i> | <i>Shore A</i> |
|---------------|----------|----------|----------|----------|----------|-----------|------------------|----------------|
| ★ 06953 | 44 | 40 | 33 | 54 | 39 | 10 | NBR/PVC | 65 |
| ★ 06953/A | 44 | 40 | 20 | 54 | 39 | 10 | NBR/PVC | 65 |
| ★ 06953/B | 44 | 40 | 33 | 54 | 39 | 10 | NBR/PVC | 65 |
| 06953/C | 43 | 43 | 34 | 54 | 39 | 10 | NBR/PVC | 65 |
| 06955/C | 43,5 | 43,5 | 40 | 59 | 39 | 10 | NBR/PVC | 65 |
| 08991/A | 43 | 43 | 37 | 54 | 34 | 10 | NBR/PVC | 65 |

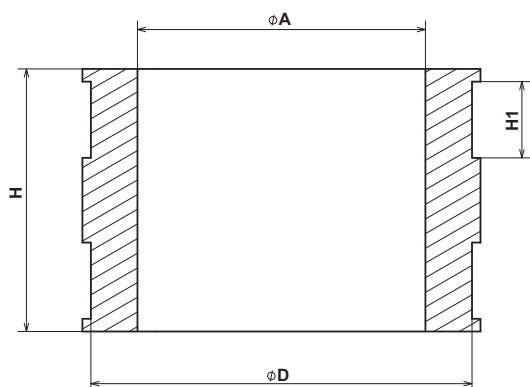

| <i>Codice</i> | <i>A</i> | <i>B</i> | <i>C</i> | <i>D</i> | <i>H</i> | <i>H1</i> | <i>Materiale</i> | <i>Shore A</i> |
|---------------|----------|----------|----------|----------|----------|-----------|------------------|----------------|
| 08909 | 34 | - | - | 45 | 31 | 9 | NBR/PVC | 65 |



Descrizione degli anelli di tenuta paraolio

Gli anelli di tenuta paraolio rappresentano la migliore soluzione tecnica per quelle applicazioni che richiedono una perfetta tenuta di olii, grassi e simili intorno agli alberi rotanti.

Una notevole varietà di labbri di tenuta, parti metalliche strutturali e molle di tenuta è a disposizione dei Progettisti meccanici per meglio individuare il paraolio più adatto allo scopo specifico.

I materiali dei Labbri di tenuta, armature metalliche e molle.

Labbri di tenuta

- **Nitrile** Buna-N 70 è l'elastomero standard generalmente usato per i nostri paraolio ed è indicato per la maggior parte delle applicazioni motoristiche. Il labbro in Nitrile lavora in modo eccellente entro una gamma di temperature da -35°C a +125°C ed è resistente a molti olii e grassi minerali.
- **Silicone**, si tratta di un elastomero pregiato usato per le resistenze a temperature più elevate. Trova il suo impiego ideale tra -65°C e +190°C.
A causa del costo elevato si impiega in casi particolari.
- **Viton** è l'elastomero, fluorurato, di maggior pregio. Offre resistenze a temperature molto elevate in una gamma operativa da -40°C a +210°C.
Questo materiale resiste ottimamente ad olii, acidi ed altre sostanze che sono distruttive per il Nitrile od i Siliconi. È estremamente resistente alla abrasione ed ha performances eccezionali. Trova applicazione in quelle condizioni di criticità che altrimenti non avrebbero soluzione.

NITRILE, SILICONE, VITON sono i materiali utilizzati da ARIETE per i propri PARAOLIO

Armature metalliche strutturali e molle di tenuta

Se non specificato espressamente tutte le armature metalliche strutturali dei paraolio ARIETE sono ricavate da acciaio ad alto contenuto di carbonio. In applicazioni dove la corrosione potrebbe rappresentare un problema si utilizza acciaio inox ed il rivestimento elastomerico esterno protegge ulteriormente il paraolio.

I disegni delle seguenti sezioni rappresentano i paraolio comunemente usati nel settore motociclistico e motoristico.

ARIETE, gli speciali paraolio per moto & scooters

I nostri anelli di tenuta paraolio per alberi rotanti sono prodotti con una miscela elastomerica specificatamente studiata per la resistenza agli olii ed alle temperature che normalmente sono presenti nei motori.

Abbiamo in gamma circa 400 modelli di paraolio che vengono impiegati nel settore motociclistico.

L'alta qualità dei materiali utilizzati e l'ottimo grado di finitura, con rettifica dei labbri di tenuta fanno di questi paraolio un prodotto di alto livello tecnologico e di consolidato affidamento.

ARIETE, trade mark della Sandro Mentasti Srl di Varese, operante in Italia dal 1947, è sinonimo di alta qualità per accessori e ricambi, in gomma e materie plastiche, di motocicli e scooters.

Nel Febbraio 1998 il Sistema Qualità della Sandro Mentasti Srl ha ottenuto la Certificazione UNI EN ISO 9002 dal prestigioso Ente Certificatore scandinavo Det Norske Veritas, DNV.

Questo alto riconoscimento ufficiale ed internazionale rappresenta il punto di partenza del continuo miglioramento perseguito dalla nostra Azienda per il raggiungimento di una sempre maggior soddisfazione dei nostri Clienti.

ARIETE, tradizione della qualità

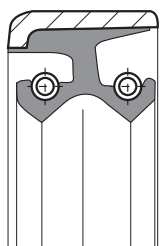

DB
2 labbri
lamiera esterna

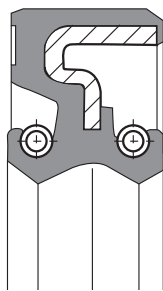

DC2Y
2 labbri

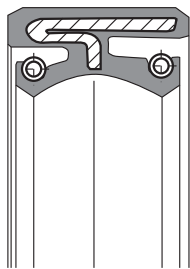

DCR2
2 labbri

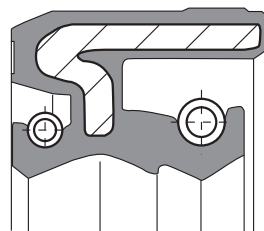

DCY
2 labbri

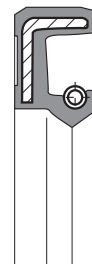

HSCJ
1 labbro

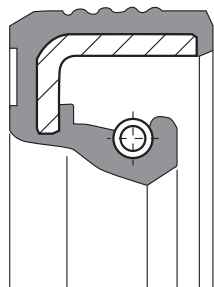

HSCR
1 labbro

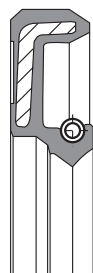

HSCRY
1 labbro

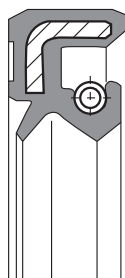

HTCL
1 labbro
+ parapolvere

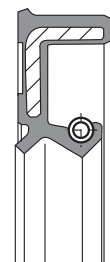

HTCYL
1 labbro
+ parapolvere



KC
senza molla
+ parapolvere

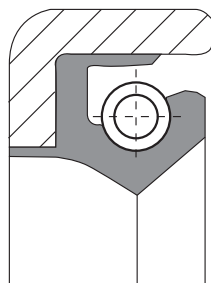

SB
1 labbro
lamiera esterna

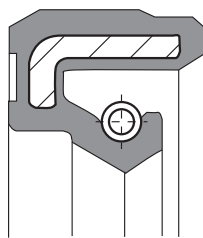

SC
1 labbro

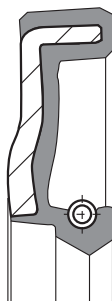

SCY
1 labbro

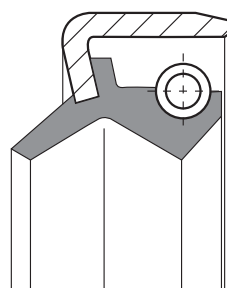

TBY
1 labbro
+ parapolvere
lamiera esterna

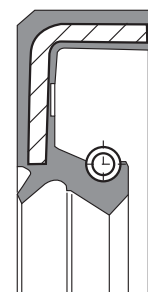

TC
1 labbro
+ parapolvere

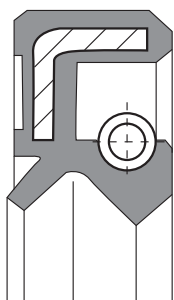

TCJ
1 labbro
+ parapolvere

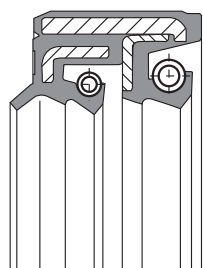

TCL4Y
2 labbri
+ parapolvere

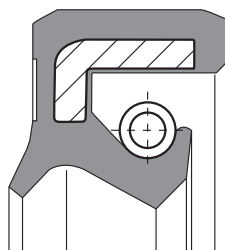

TCY
1 labbro
+ parapolvere

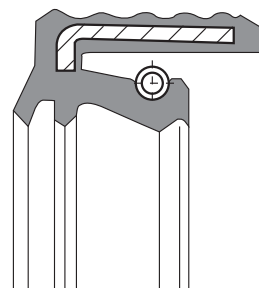

TG6
1 labbro
+ 2 parapolvere

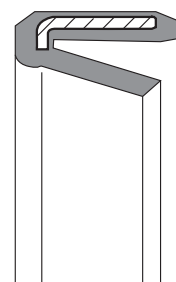

VC
senza molla

| <i>Codice</i> | <i>Sezione</i> | <i>Misura</i> | <i>Materiale</i> |
|---------------|----------------|---------------|------------------|
| P/275 | VC | 11x6x4 | NBR |
| P/294 | SB | 11X6X4 | NBR |
| P/269 | VB | 12x8x3 | NBR |
| P/001 | VC | 14,5x4,8x4 | NBR |
| P/002 | TC | 14,5x6,5x7 | NBR |
| P/309 | SB | 16 X 8 X 5 | NBR |
| P/004 | SC | 16x6x7 | NBR |
| P/005 | SC | 16x7x7 | NBR |
| P/337 | DCR2 | 16X8X10 | NBR |
| P/361 | TG6 | 16X8X10/11 | NBR |
| P/296 | SB | 17X11X4 | NBR |
| P/283 | YC | 17x12x2,5 | NBR |
| P/006 | SC | 18x10x4 | NBR |
| P/325 | TC | 18X10X4 | NBR |
| P/343 | DCY | 18X10X5/8 | NBR |
| P/276 | VC5 | 18x12x11 | NBR |
| P/007 | VC | 18x12x3 | NBR |
| P/284 | TC | 18x12x5 | NBR |
| P/292 | TC | 18X7X5 | NBR |
| P/301 | TC | 18X9X7 | NBR |
| P/009 | SC | 19x10x7 | NBR |
| P/010 | VC | 19x12x3 | NBR |
| P/291 | SC | 19X12X5 | NBR |
| P/011 | VC | 19x13x3 | NBR |
| P/008 | SC | 19x6x7 | NBR |
| P/310 | SB | 20X12X5 | NBR |
| P/311 | TC | 20X13X4 | NBR |
| P/274 | VB | 20x16x2,5 | NBR |
| P/307 | SC | 21X10X5 | NBR |
| P/326 | TC | 21X10X5 | NBR |
| P/312 | TC | 22X10X6 | NBR |
| P/015 | SC | 22x10x8 | NBR |
| P/016 | SC | 22x12x5 | NBR |
| P/285 | TC | 22x12x5 | NBR |
| P/017 | SC | 22x12x7 | NBR |
| P/018 | TC | 22x12x7 | NBR |
| P/019 | SC | 22X13X4 | W/PTFE |
| P/020 | SC | 22x14x4 | NBR |
| P/286 | SCY | 22x14x5 | NBR |
| P/021 | VC | 22x14x7 | NBR |
| P/022 | VC | 22x16x3 | NBR |
| P/012 | SC | 22x6x7 | NBR |
| P/014 | SC | 22x8x7 | NBR |

| <i>Codice</i> | <i>Sezione</i> | <i>Misura</i> | <i>Materiale</i> |
|---------------|----------------|---------------|------------------|
| P/023 | VC | 23x17x3 | NBR |
| P/024 | TC | 24X12X7 | NBR |
| P/025 | SC | 24x13,7x5 | NBR |
| P/313 | SB | 24X13X6 | NBR |
| P/295 | TC | 24X14X7 | NBR |
| P/027 | SC | 24x15x5 | NBR |
| P/028 | SC | 24x15x7 | NBR |
| P/029 | TC | 24x15x7 | NBR |
| P/030 | DB | 24x15x7 | NBR |
| P/031 | VC | 24x16x4 | NBR |
| P/032 | SC | 24x16x5 | NBR |
| P/034 | DB | 24x16x7 | NBR |
| P/035 | VC | 24x18x4 | NBR |
| P/358 | TC | 25X12X7 | NBR |
| P/349 | HSCR | 25X12X8 | NBR |
| P/037 | TC | 25x15x7 | NBR |
| P/364 | VB | 25x17x3 | NBR |
| P/038 | SC | 25x17x4 | NBR |
| P/302 | TC | 25,5X15,6X7 | SILICONE |
| P/277 | SC | 26X10X7 | NBR |
| P/039 | SC | 26x12x8 | NBR |
| P/040 | SC | 26x13x5 | NBR |
| P/041 | SC | 26x15x7 | NBR |
| P/042 | TC | 26x15x7 | NBR |
| P/043 | DB | 26x15x7 | NBR |
| P/278 | TC | 26X16X6 | NBR |
| P/044 | VC | 26x20x4 | NBR |
| P/320 | SCAX | 27X14X6 | NBR |
| P/045 | SC | 27x15x7 | NBR |
| P/299 | TC | 27X17X5 | NBR |
| P/355 | HTCL | 27X17X5 | NBR |
| P/354 | TCJ | 27X17X6 | VITON |
| P/046 | SC | 27x19x6 | NBR |
| P/047 | SC | 28x12x7 | NBR |
| P/303 | TC | 28X12X7 | NBR |
| P/049 | TC | 28x14x7 | NBR |
| P/281 | SC | 28X15X5 | NBR |
| P/050 | SC | 28x15x7 | NBR |
| P/051 | SC | 28x16x7 | NBR |
| P/279 | TC | 28x16x7 | NBR |
| P/340 | HTCL | 28X17X5,5 | NBR |
| P/052 | SC | 28x17x6 | NBR |
| P/321 | TC | 28X17X6 | NBR |

| <i>Codice</i> | <i>Sezione</i> | <i>Misura</i> | <i>Materiale</i> | <i>Codice</i> | <i>Sezione</i> | <i>Misura</i> | <i>Materiale</i> |
|---------------|----------------|---------------|------------------|---------------|----------------|---------------|------------------|
| P/053 | SC | 28x17x7 | NBR | P/086 | SC | 32x17x7 | NBR |
| P/054 | TC | 28x17x7 | NBR | P/088 | SC | 32x18x8 | NBR |
| P/055 | DB | 28x17x7 | NBR | P/090 | SC | 32x19,8x5 | NBR |
| P/359 | TC | 28X17X7/6 | NBR | P/089 | SC | 32x19x7 | NBR |
| P/056 | TC | 28x18x7 | NBR | P/287 | HTCL | 32x20x6 | NBR |
| P/057 | VB | 28x20x4 | NBR | P/092 | SC | 32x20x7 | NBR |
| P/058 | SC | 28x20x6 | NBR | P/093 | TC | 32x20x7 | NBR |
| P/293 | TB | 28 X 20 X 6 | NBR | P/318 | SB | 32X20X7 | NBR |
| P/059 | TC | 29x18x7 | NBR | P/347 | HSCR | 32X20X7 | SILICONE |
| P/060 | SC | 30x12x7 | NBR | P/095 | SC | 32x22x5,5 | NBR |
| P/061 | SC | 30x14x7 | NBR | P/342 | TC | 32X22X6 | NBR |
| P/067 | SC | 30x15x10 | NBR | P/096 | SC | 32x22x7 | NBR |
| P/335 | TC | 30X15X5 | NBR | P/272 | TC | 32x22x7 | NBR |
| P/062 | SC | 30x15x7 | NBR | P/097 | SC | 33x25x4 | NBR |
| P/063 | TC | 30x15x7 | NBR | P/098 | SC | 34x20x7 | NBR |
| P/064 | DB | 30x15x7 | NBR | P/099 | SC | 34x24x5,5 | NBR |
| P/065 | SC | 30x15x8 | NBR | P/100 | SC | 35x11x10 | NBR |
| P/066 | SB | 30x15x8 | NBR | P/103 | SC | 35x15x10 | NBR |
| P/069 | SC | 30x17x5 | NBR | P/101 | SC | 35x15x7 | NBR |
| P/304 | TC | 30X17X5 | NBR | P/102 | SC | 35x15x8 | NBR |
| P/070 | TCY | 30x17x6/6,5 | NBR | P/110 | SC | 35x17x10 | NBR |
| P/071 | SC | 30x17x7 | NBR | P/104 | SC | 35x17x5 | NBR |
| P/072 | TC | 30x17x7 | NBR | P/105 | SC | 35x17x7 | NBR |
| P/073 | SB | 30x17x7 | NBR | P/106 | TC | 35x17x7 | NBR |
| P/074 | DB | 30x17x7 | NBR | P/107 | DB | 35x17x7 | NBR |
| P/075 | SC | 30x18x7 | NBR | P/108 | SC | 35x17x8 | NBR |
| P/305 | TCR | 30X19X7 | NBR | P/109 | SB | 35X17X8 | NBR |
| P/327 | TCRV | 30X19X7 | VITON | P/111 | SC | 35x18x8 | NBR |
| P/076 | SC | 30x20x5 | NBR | P/114 | SC | 35x20x10 | NBR |
| P/077 | SC | 30x20x7 | NBR | P/288 | SC | 35x20x5,5 | NBR |
| P/297 | TCJ | 30X20X7 | W/PTFE | P/360 | TC | 35X20X7 | NBR |
| P/322 | TC | 30X20X7 | NBR | P/113 | TCY | 35x20x7/7,5 | NBR |
| P/078 | DB | 30x20x8 | NBR | P/362 | DC2Y | 35X20X7 | VITON |
| P/080 | VC | 30x24x7 | NBR | P/118 | SC | 35x22x10 | NBR |
| P/339 | SC5 | 30/33.5X20X6 | NBR | P/116 | S | 35x22x7 | NBR |
| P/081 | VCY | 31x7x7,5/11 | NBR | P/117 | SC | 35x22x8 | NBR |
| P/298 | TCJ | 31X20X7 | W/PTFE | P/119 | TC | 35x23x6 | NBR |
| P/365 | VB | 31x25x2,5 | NBR | P/120 | HSCR | 35x24x6 | NBR |
| P/082 | SC | 31,5x13x3,5 | NBR | P/121 | SC | 35x24x7 | NBR |
| P/083 | SC | 32x15x5 | NBR | P/124 | TBY | 35x25,7x7/9 | NBR |
| P/084 | SC | 32x15x7 | NBR | P/122 | SC | 35x25x7 | NBR |
| P/087 | SC | 32x17x10 | NBR | P/127 | SC | 35x26x10 | NBR |
| P/085 | SC | 32x17x5 | NBR | | | | |

| <i>Codice</i> | <i>Sezione</i> | <i>Misura</i> | <i>Materiale</i> |
|---------------|----------------|---------------|------------------|
| P/126 | TC | 35x26x7 | NBR |
| P/329 | SB | 35X26X7 | NBR |
| P/280 | TCY | 36x24x7 | NBR |
| P/300 | TC | 37X24X5 | NBR |
| P/128 | SC | 37x25x5 | NBR |
| P/353 | TCJ | 37X25X6 | VITON |
| P/130 | SC | 37x27x7 | NBR |
| P/131 | TC | 37x27x7 | NBR |
| P/346 | HTCYL | 38X20X7 | NBR |
| P/290 | TC | 38X25X7 | NBR |
| P/315 | TCJ | 38X25X7 | W/PTFE |
| P/132 | SC | 38x28x7 | NBR |
| P/133 | TC | 38x28x7 | NBR |
| P/316 | TCJ | 38X28X7 | VITON |
| P/136 | SC | 39/34x22x5,5 | NBR |
| P/341 | KC | 39X33X4 | NBR |
| P/317 | TCJ | 40 X 25 X 7 | W/PTFE |
| P/138 | SC | 40x17x6 | NBR |
| P/139 | SC | 40x17x7 | NBR |
| P/140 | TCY | 40x17x7/7,7 | NBR |
| P/141 | SC | 40x17x8,5 | NBR |
| P/145 | SC | 40x20x10 | NBR |
| P/143 | DC | 40x20x7 | NBR |
| P/144 | DB | 40x20x8/02 | NBR |
| P/146 | SC | 40x22x7 | NBR |
| P/334 | HSCJ | 40X22X7 LEFT | W/PTFE |
| P/147 | SC | 40x23x10 | NBR |
| P/270 | HSCRY | 40X24,9X6,5 | VITON |
| P/148 | TC | 40x24x7 | NBR |
| P/154 | DC | 40x25x12 | NBR |
| P/324 | SCB | 40X25X3 | NBR |
| P/149 | TC | 40x25x6 | NBR |
| P/323 | HTCL | 40X25X6 | NBR |
| P/150 | SC | 40x25x7 | NBR |
| P/151 | TC | 40x25x7 | NBR |
| P/152 | TBY | 40x25x7 | NBR |
| P/153 | TCY | 40x25x9/7 | NBR |
| P/338 | SCR | 40X26,5X9 | NBR |
| P/352 | TC | 40X27X6 | NBR |
| P/156 | TC | 40x28x7 | NBR |
| P/157 | SC | 40x30x7 | NBR |

| <i>Codice</i> | <i>Sezione</i> | <i>Misura</i> | <i>Materiale</i> |
|---------------|----------------|-------------------|------------------|
| P/158 | TCYSC | 40x30x7/9 | NBR |
| P/160 | SC | 41x29x5 | NBR |
| P/333 | HTCY | 42/43X20X8,9 | NBR |
| P/161 | SC | 42x15x10 | NBR |
| P/308 | SB | 42X20X10 | NBR |
| P/162 | SC | 42x20x7 | NBR |
| P/163 | SB | 42x20x7/02 | NBR |
| P/330 | TCBYR | 42X20X7/9 | W/PTFE |
| P/165 | SC | 42x22x10 | NBR |
| P/164 | SC | 42x22x7 | NBR |
| P/166 | SC | 42x25x6 | NBR |
| P/167 | TC | 42x25x8 | NBR |
| P/168 | SC | 42x25x8,5 | NBR |
| P/336 | TGJ | 42X26X7 | W/PTFE |
| P/170 | SC | 42x27x10 | NBR |
| P/171 | SC | 42x28x7 | NBR |
| P/172 | SC | 42x30x7 | NBR |
| P/173 | HSC | 42x30x8 | NBR |
| P/175 | TCY | 42x32x7/9 | NBR |
| P/351 | KC | 43X24X6 | NBR |
| P/282 | SCY/5 | 44x32x8 | NBR |
| P/178 | SC | 45x24,9x6,5 | NBR |
| P/179 | HSCRY | 45X24,9X6,5/5,5 | NBR |
| P/289 | TC | 45x25x7 | NBR |
| P/314 | SC | 45X32X5 | NBR |
| P/181 | SC | 45x32x6 | NBR |
| P/271 | TC | 45x32x7 | NBR |
| P/319 | TC | 46,43X31,75X9,5 | NBR |
| P/183 | SC | 46x34x10 | NBR |
| P/189 | SCY | 47 X 22,7 X 7/7,5 | NBR |
| P/344 | TBR | 47,63X33,34X11,1 | XNBR |
| P/345 | TBR | 47,63X34,13X11,1 | XNBR |
| P/187 | SC | 47x20x10 | NBR |
| P/184 | SC | 47x20x7 | NBR |
| P/186 | SC | 47x20x8 | NBR |
| P/188 | SC | 47x22x10 | NBR |
| P/191 | SC | 47x25x10 | NBR |
| P/192 | SC | 47x27x6 | NBR |
| P/194 | SC | 47x28x7 | NBR |
| P/348 | HSCR | 47X28X7 | NBR |
| P/198 | SC | 47x30x10 | NBR |
| P/195 | SC | 47x30x6 | NBR |

| <i>Codice</i> | <i>Sezione</i> | <i>Misura</i> | <i>Materiale</i> |
|---------------|----------------|---------------|------------------|
| P/197 | TC | 47x30x7 | NBR |
| P/200 | SC | 47X32X12 | VITON |
| P/199 | SC | 47x32x7 | NBR |
| P/201 | SC | 47x35x7 | NBR |
| P/202 | TCY | 47x35x7/9 | NBR |
| P/328 | SB | 47X40X4 | NBR |
| P/204 | TCL4Y | 48X35X13,2/15 | NBR |
| P/206 | SC | 50x25x10 | NBR |
| P/207 | TC | 50x30x10 | NBR |
| P/208 | TC | 50x33x6 | NBR |
| P/210 | SC | 50x36x7 | NBR |
| P/211 | SC | 50x38x7 | NBR |
| P/212 | TCY | 50x38x7/9 | NBR |
| P/214 | SC | 52x20x10 | NBR |
| P/217 | SC | 52x25x10 | NBR |
| P/215 | TC | 52x25x7 | NBR |
| P/363 | DC | 52X25X8 | NBR |
| P/216 | SC | 52X25X9/01 | NBR |
| P/218 | SC | 52x30x10 | NBR |
| P/219 | SC | 52x31x7 | NBR |
| P/220 | SC | 52x32x5 | NBR |
| P/221 | SC | 52x32x7 | NBR |
| P/222 | DB | 52x32x7/9 | NBR |
| P/224 | SC | 52x33x6 | NBR |
| P/225 | SC | 52x34x10 | NBR |
| P/226 | SC | 52x35x10 | NBR |
| P/228 | SC | 52x38x10 | NBR |
| P/232 | TC4 | 54x43x11 | XNBR |
| P/240 | SC | 55,5x38x9 | NBR |
| P/234 | TC | 55x30x10 | NBR |
| P/233 | SC | 55x30x7 | NBR |
| P/235 | TC | 55x35x9 | NBR |
| P/237 | TC | 55x40x7 | NBR |
| P/238 | TC4Y | 55x41,7x8 | NBR |
| P/241 | SC | 56x40x8 | NBR |
| P/242 | SC | 56x42x7 | NBR |
| P/243 | DB | 58x45x7 | NBR |
| P/244 | SB5Y | 60/40X20X6 | NBR |
| | | TACCA QUADRA | |
| P/245 | TB5 | 60/40X20X6 | NBR |
| | | TACCA TONDA | |
| P/246 | SC | 60x40x10 | NBR |
| P/247 | SC | 60x42x10 | NBR |

| <i>Codice</i> | <i>Sezione</i> | <i>Misura</i> | <i>Materiale</i> |
|---------------|----------------|-----------------|------------------|
| P/248 | SC | 60x45x7 | NBR |
| P/252 | TB5 | 61/50x33x6 | NBR |
| P/253 | SC5 | 61/57X32X6 | NBR |
| P/257 | SCY | 62 X 32 X 6/7 | NBR |
| P/256 | SBY | 62,5X31X4,3/5,8 | NBR |
| P/251 | SC | 62x20x6,5 | NBR |
| P/255 | SCY | 62x25x7/8 | NBR |
| P/259 | SC | 62x32x8 | NBR |
| P/273 | SCY | 62x34x6 | NBR |
| P/260 | SC | 62x37x8 | NBR |
| P/261 | SC | 62x45x10 | NBR |
| P/262 | TC | 65x45x10 | NBR |
| P/263 | SC | 65x50x8 | NBR |
| P/264 | SC | 68x53x10 | NBR |
| P/356 | SC | 70X40X7,5 | NBR |
| P/357 | SC | 85X65X10,5 | NBR |
| P/266 | SC | 85x70x8 | NBR |
| P/267 | SC | 90x75x8 | NBR |
| P/268 | SC | 100 X 80 X 10 | NBR |
| P/350 | HSCL | 100X78X10 | SILICONE |

KITS Paraolio

Gli anelli di tenuta per alberi rotanti sono prodotti con una miscola di gomma resistente agli olii ed alle alte temperature. L'Ariete propone dei kits paraolio motore selezionati per ogni tipo di moto o scooter in circolazione.

L'alta qualità dei materiali impiegati e la "rettifica" di ogni anello eseguita con una apposita macchina a controllo sono alla base del successo di questa linea di prodotti stimati ed apprezzati dai Meccanici più esperti ed esigenti.



| Old Codice | Marca | Anno | Modello | Applicazione |
|------------|---------------|-------|--|--------------------------|
| ☆ 04887 | AERMACCHI | | 125 CC. 2T | MOTORE E CAMBIO |
| ☆ 08861 | AERMACCHI | | 175-250 CC. | MOTORE |
| ☆ 02854 | APE | | 150/C | POMPA FRENI |
| ☆ 04877 | APE | | 3ª SERIE | CEPPI FRENO |
| ☆ 07876 | APE | | C/4 '62-AD-AE-AEO | CEPPI FRENO |
| 08869 | APE | | AD/1 175-MP/CAR | POMPA CENTRALE |
| 08878 | APE | | 175-MP-MPR-MPN-MPV-CAR-P400-P601 | MOTORE |
| ☆ 08894 | APE | | MP DIAM.20 | CEPPI FRENO RUOTA ANT. |
| 08894/A | APE | | MP DIAM.22 | CEPPI FRENO ANTERIORE |
| 09857 | APE | | APE P 50 - APE TM P 50 - FL2 | POMPA FRENI |
| 09858 | APE | | 50 CC. | CEPPI FRENO |
| 09891 | APE | | MP-MPV-MPR-CAR | FRENO CILINDRETTI POST. |
| 11870 | APE | | TM/602-TM/703 | POMPA CENTRALE |
| 11871 | APE | | TM P/602-TM P/703 | CEPPI FRENO ANT. E POST. |
| ☆ 11886 | APE | | P.501 - P.601 II SERIE DAL 1985 | MOTORE |
| 11893 | APE | | APE 50 -TM - P50/FL2 | CEPPI FRENO POST. |
| 11862 | APRILIA | | 125 ETX '84 - ROTAX 126 LC | MOTORE |
| 11863 | APRILIA | | 125 TUAREG 2ª SERIE '85/87 LC RAVE MISC | MOTORE |
| 11864 | APRILIA | | 125 TUAREG RALLY '84/87 | MOTORE |
| 11879 | APRILIA | | 125 SINTESI | MOTORE |
| 11895 | APRILIA | 94-99 | AMICO YOUNGER - BUSINESS - CLUB | MOTORE |
| 11896 | APRILIA | 95-98 | SCARABEO 50 | MOTORE |
| 11896 | APRILIA | 99 | SCARABEO BRIGHT 50 - CLASSIC - DE LUXE | MOTORE |
| 11896 | APRILIA | > 97 | SR 50 WWW | MOTORE |
| 11896 | APRILIA | 97 > | SR 50 WWW | MOTORE |
| 12853 | APRILIA | 99 | AREA 51 | MOTORE |
| 12853 | APRILIA | 95-98 | GULLIVER | MOTORE |
| 12853 | APRILIA | 96-99 | GULLIVER LC | MOTORE |
| 12853 | APRILIA | 99 | MC GULLIVER LC | MOTORE |
| 12853 | APRILIA | 97-99 | RALLY 50 LC - 2FD | MOTORE |
| 12853 | APRILIA | 98-99 | SONIC - GP LC - SPICE | MOTORE |
| 12853 | APRILIA | 94-98 | SR 50 LC | MOTORE |
| 12853 | APRILIA | 99 | SR 50 RACING ROSSI FD TETSUYA FD - STEALTH FD | MOTORE |
| 12853 | APRILIA | > 97 | SR NETSCAPER LC | MOTORE |
| 12853 | APRILIA | 97 > | SR NETSCAPER LC | MOTORE |
| ☆ 09868 | ATALA | | CALIFFO 119 | MOTORE |
| 12850 | ATALA | 95-99 | HACKER AT 12 50 - LC - RACING 50 | MOTORE |
| 11852 | ATALA-RIZZATO | | 22 CON PEDALIERA-CALIFFONE | MOTORE |
| ☆ 05867 | BENELLI | | 48 CC. 3 MARCE | MOTORE |
| ☆ 07862 | BENELLI | | LEONCINO 125 CC. MOD. 1953/54 | MOTORE |
| ☆ 07863 | BENELLI | | 125 CC. MOD.1955/57 | MOTORE |
| ☆ 08875 | BENELLI | | 49 CC. 4 MARCE | MOTORE |
| ☆ 08875/A | BENELLI | | 3VP-3VK (DAL 1981) | MOTORE |
| ☆ 08884 | BENELLI | | GENTLEMAN / FAK 48 | MOTORE |

| Old Codice | Marca | Anno | Modello | Applicazione |
|------------|---------------|-------|---|--------------|
| ☆ 09861 | BENELLI | | MOTORELLA | MOTORE |
| ☆ 09894 | BENELLI | | 48 CC. 5 MARCE | MOTORE |
| ☆ 10889 | BENELLI | | 3 VKN | MOTORE |
| ☆ 09856 | BETA | | 48 CC. 4/5 MARCE | MOTORE |
| 11896 | BETA | 94-99 | TEMPO 13/16" | MOTORE |
| 10888 | BMW | | TUTTI I MODELLI FINO AL 1980 | MOTORE |
| ☆ 09890 | CAGIVA | | 350 GTS TV FINO AL 1971 | MOTORE |
| ☆ 10890 | CAGIVA | | 175 - 250 2T | MOTORE |
| ☆ 10891 | CAGIVA | | 250 MXR - RX CROSS | MOTORE |
| ☆ 10892 | CAGIVA | | 125 SS - SST - SXT - ALETTA - LOW RIDER | MOTORE |
| 10898 | CAGIVA | | 125 WSXT-ALETTA ROSSA-ELEFANT-A.ORO | MOTORE |
| 11887 | CAGIVA | | FRECCIA C9/10/12-125 TAMANACO-CRUISER | MOTORE |
| ☆ 01889 | CAPRIOLO | | 75 CC. PREMODIFICA | MOTORE |
| ☆ 03871 | CAPRIOLO | | 75 CC. POST-MODIFICA | MOTORE |
| 12858 | DERBI | | DERBI SENDA R - BULTACO LOBITO - ASTRO | MOTORE |
| ☆ 04889 | DUCATI | | 125-175 CC. | FORCELLA |
| ☆ 05861 | DUCATI | | DUCATI 100-125-175 MONOALBERO | MOTORE |
| ☆ 09882 | DUCATI | | 250-350-450 SCRAMBLER | MOTORE |
| ☆ 08873 | FRANCO MORINI | | 4 MP/S 4 MARCE 48 | MOTORE |
| ☆ 08889 | FRANCO MORINI | | GYROMATIC | MOTORE |
| 10862 | FRANCO MORINI | | GS - SA RAFFREDDATO AD ACQUA | MOTORE |
| 11885 | FRANCO MORINI | | MOTORE G 30-G 304 | MOTORE |
| 12850 | FRANCO MORINI | | MOTORE AH 50 L | MOTORE |
| ☆ 02884 | GARELLI | | MOSQUITO 38/B 2°SERIE | MOTORE |
| ☆ 08895 | GARELLI | | M EUREKA-KATIA | MOTORE |
| ☆ 09886 | GARELLI | | FLEX Matic - GULP | MOTORE |
| ☆ 10852 | GARELLI | | EUREKA - KATIA M - CHIC - NOI | MOTORE |
| ☆ 10855 | GARELLI | | 5V-E CROSS-CICLONE | MOTORE |
| ☆ 10893 | GARELLI | | VIP 1 - 2 - 3 - 4 | MOTORE |
| 11898 | GARELLI | | GARELLI SUPER CICLONE - TEAM - TIGER | MOTORE |
| 02857 | GILERA | | 98-124-150 CC. 5V SPECIAL | FORCELLA |
| ☆ 04891 | GILERA | | 150-175 CC. | FORCELLA |
| 05851 | GILERA | | B300 BICILINDRICA DAL 1953/1969 | FORCELLA |
| ☆ 05886 | GILERA | | 98-124 GIUBILEO | MOTORE |
| ☆ 07860 | GILERA | | GIUBILEO 175-202 CC. | FORCELLA |
| ☆ 09888 | GILERA | | 50 5V TRIAL | MOTORE |
| 09889 | GILERA | | 98-124 CC. | MOTORE |
| ☆ 10899 | GILERA | | 125 RV-RX-ARIZONA-200 RX | MOTORE |
| ☆ 11875 | GILERA | | 125 KK-KZ-TOP RALLY-SP01 | MOTORE |
| 11891 | GILERA | | STORM | MOTORE |
| 11891 | GILERA | 94-97 | TYPHOON | MOTORE |
| 11891 | GILERA | 99 | TYPHOON X | MOTORE |
| 11891 | GILERA | < 97 | TYPHOON BENETTON - MARTINI - STREET | MOTORE |

| Old Codice | Marca | Anno | Modello | Applicazione |
|------------|---------|-------|--|----------------------|
| 11891 | GILERA | 95-97 | ZIP EASY MOVING 50 | MOTORE |
| 12855 | GILERA | 99 | TYPHOON X 125 | MOTORE |
| 12855 | GILERA | 95-98 | TYPHOON 125 FORCELLA SHOWA | MOTORE |
| ☆ 01870 | GUZZI | | 65 CC. | MOTORE |
| ☆ 01870/A | GUZZI | | CARDELLINO 73 CC. | MOTORE |
| ☆ 02882 | GUZZI | | GALLETTO 192 CC. | MOTORE |
| ☆ 03861 | GUZZI | | ERCOLE 1 TIPO | CEPPI FRENO |
| ☆ 03863 | GUZZI | | ERCOLINO | CEPPI FRENO |
| ☆ 03864 | GUZZI | | 250-500 CC. | FORCELLA |
| ☆ 05883 | GUZZI | | ERCOLE ULTIMO TIPO | POMPA FRENO |
| ☆ 05884 | GUZZI | | ERCOLINO ULTIMO TIPO | POMPA FRENO |
| ☆ 05885 | GUZZI | | ERCOLE ULTIMO TIPO | CEPPI FRENO |
| ☆ 05889 | GUZZI | | LODOLA 175 CC SPORT | MOTORE |
| ☆ 07857 | GUZZI | | ZIGOLO 110 CC. | FORCELLA TELESCOPICA |
| ☆ 07868 | GUZZI | | STORNELLO 125 CC. | MOTORE |
| ☆ 07868/S | GUZZI | | STORNELLO 125 CC. - SILICONE | MOTORE |
| ☆ 07869 | GUZZI | | STORNELLO 125 SPORT - 160 CC. | MOTORE |
| ☆ 07869/A | GUZZI | | STORNELLO 160 CC. 5 MARCE | MOTORE |
| ☆ 07869/AS | GUZZI | | STORNELLO 160 CC. - SILICONE | MOTORE |
| ☆ 07869/S | GUZZI | | STORNELLO SPORT 125/160 CC. - SILICONE | MOTORE |
| ☆ 08877 | GUZZI | | DINGO-DINGO CROSS | MOTORE |
| ☆ 08887 | GUZZI | | ERCOLE | MOTORE |
| ☆ 09851 | GUZZI | | V7 | FORCELLA |
| ☆ 09870 | GUZZI | | NUOVO FALCONE | FORCELLA |
| ☆ 09878 | GUZZI | | V7 SPECIAL | MOTORE |
| ☆ 09879 | GUZZI | | V7 SPECIAL | CAMBIO |
| ☆ 09880 | GUZZI | | V7 SPECIAL | TRASMISSIONE |
| 09896 | GUZZI | | NUOVO FALCONE MILITARE | MOTORE |
| 10869 | GUZZI | | 850 T-T3-LE MANS-1000 | MOTORE E CAMBIO |
| 11869 | GUZZI | | V35-V50-V65-V75-V35 IMOLA 2 SERIE | MOTORE |
| 11861 | HONDA | | 125 MTX-NS F | MOTORE |
| 11868 | GUZZI | | V35 - V50 1° SERIE - SOLO MOTORE | MOTORE E CAMBIO |
| 11873 | HONDA | | XL 600 R | MOTORE |
| 11874 | HONDA | | XL 600 LMN-LMF-RM/G | MOTORE |
| 11880 | HONDA | | NSR 125 F/R | MOTORE |
| 11882 | HONDA | > 96 | SH 50 | MOTORE |
| 11882 | HONDA | 94-99 | SH 50 FIFTY | MOTORE |
| 11899 | HONDA | 95-99 | BALI | MOTORE |
| 12857 | HONDA | 96 > | SH 50 NEW - SKY 50 - SH 100 | MOTORE |
| 12850 | ITALJET | 94-99 | FORMULA 50 - LC - WILLIAMS | MOTORE |
| 12850 | ITALJET | | SPORT GT | MOTORE |
| 12850 | ITALJET | 97-99 | TORPEDO | MOTORE |
| 12850 | ITALJET | 94-99 | VELOCIFERO | MOTORE |
| 12850 | ITALJET | 99 | VELOCIFERO 10" | MOTORE |

| Old Codice | Marca | Anno | Modello | Applicazione |
|------------|-----------|-------|---|----------------------|
| ☆ 06879 | LAMBRETTA | | LAMBRO FLI 2ª SERIE 450-550N-550V | POMPA FRENO |
| ☆ 06880 | LAMBRETTA | | LI | MOTORE E RUOTA POST. |
| ☆ 07898 | LAMBRETTA | | LI 125-150 SPECIAL 2% | MOTORE E RUOTE |
| ☆ 08871 | LAMBRETTA | | JUNIOR 50-100-125 CC. | MOTORE |
| 08893 | LAMBRETTA | | LI 125-150 3ª SERIE | MOTORE |
| 09869 | LAMBRETTA | | LAMBRO 450-550-550 V | CEPPI FRENO |
| 11896 | MALAGUTI | 94-99 | CENTRO SL 50 | MOTORE |
| 11896 | MALAGUTI | 99 | CENTRO SL 50 M | MOTORE |
| 11896 | MALAGUTI | 94-99 | F 10 JET LINE 50 - F 10 TIGERS 50 | MOTORE |
| 11896 | MALAGUTI | 94-99 | F 12 PHANTOM 50 | MOTORE |
| 11896/AE | MALAGUTI | | MOTORE (PREZZO ECONOMICO) | MOTORE |
| 12850 | MALAGUTI | 95-99 | CROSSER 50 | MOTORE |
| 12850 | MALAGUTI | 95-99 | CROSSER 50 METALLIZZATO | MOTORE |
| 12853 | MALAGUTI | 95-99 | F 12 PHANTOM 50 LC | MOTORE |
| 12853 | MALAGUTI | 95-99 | F 12 PHANTOM 50 LC METALLIZZATO | MOTORE |
| 12853 | MALAGUTI | 99 | F 12 PHANTOM 50 LC 2 FD | MOTORE |
| 12853 | MALAGUTI | 97-98 | F 15 FIREFOX 50 LC | MOTORE |
| 12853 | MALAGUTI | 97-98 | F 15 FIREFOX 50 LC METALLIZZATO | MOTORE |
| 11895 | MBK | 95-99 | BOOSTER NEXT GENERATION | MOTORE |
| 11895 | MBK | 94-97 | BOOSTER R 50 | MOTORE |
| 11895 | MBK | 96-99 | BOOSTER ROAD SPRINT - ROCKET - TRAK | MOTORE |
| 11895 | MBK | | SORRISO | MOTORE |
| 11896 | MBK | 94-99 | EVOLIS 50 | MOTORE |
| 11896 | MBK | 95-97 | FIZZ 50 | MOTORE |
| 11896 | MBK | | FORTE | MOTORE |
| 08874 | MINARELLI | | P4 4 MARCE | MOTORE |
| 08874/A | MINARELLI | | RV 4 RAFFREDDATO AD ACQUA | MOTORE |
| 08874/LG | MINARELLI | | P4 4 MARCE (LAMIERA ESTERNA) | MOTORE |
| 09850 | MINARELLI | | MOTORE V1 | MOTORE |
| 09871 | MINARELLI | | MOTORE P6 | MOTORE |
| 09871/A | MINARELLI | | MOTORE P6 4 MARCE MODIFICATO | MOTORE |
| 11895 | MINARELLI | | MOTORE MBK-BOOSTER-ZUMA SCARABEO-AMICO-BWS | MOTORE |
| 11895/AE | MINARELLI | | MOTORE (PREZZO ECONOMICO) | MOTORE |
| 11897 | MINARELLI | | MOTORE 345 | MOTORE |
| 11897/A | MINARELLI | | MOTORE AM6 | MOTORE |
| 12853 | MINARELLI | | MOTORI RAFFREDDATI A LIQUIDO | MOTORE |
| 12859 | MINARELLI | | SCOOTER 50 CC (SOLO 2 PEZZI) | ALBERO MOTORE |
| ☆ 03897 | MORINI | | 175 CC. | MOTORE |
| ☆ 05893 | MORINI | | SBARAZZINO | FORCELLA |
| ☆ 05894 | MORINI | | SBARAZZINO 98 CC. CORSARO 125 CC. | MOTORE |
| ☆ 05894/A | MORINI | | CORSARO VELOCE 150 CC. | MOTORE |
| ☆ 06881 | MORINI | | CORSARO MOD.1960 | MOTORE |
| ☆ 08870 | MORINI | | CORSARINO | MOTORE |

| Old Codice | Marca | Anno | Modello | Applicazione |
|------------|-----------|-------|---|----------------------|
| ☆ 07859 | MOTOM | | 48 CC. MOD. 51 JUNIOR 1960/1962 | MOTORE |
| ☆ 01897 | MV | | CST CS CGS | GUARNIZIONI MOTORE |
| 11885 | MOTOVESPA | | VESPINO ESPANA | GUARNIZIONI MOTORE |
| 11882 | PEUGEOT | | METROPOLIS | MOTORE |
| 11884 | PEUGEOT | | ST - RAPIDO | MOTORE |
| 11894 | PEUGEOT | | BUXY | MOTORE |
| 11894 | PEUGEOT | | BUXY RS | MOTORE |
| 11894 | PEUGEOT | > 96 | SPEEDAKE | MOTORE |
| 11894 | PEUGEOT | | SV 50 EXECUTIVE | MOTORE |
| 11894 | PEUGEOT | 94-98 | SV 50 GEO | MOTORE |
| 11894 | PEUGEOT | 95-99 | ZENITH 50 N - S | MOTORE |
| 07872 | PIAGGIO | | VESPA 150 CC. 2% | CARBURATORE |
| ☆ 08853 | PIAGGIO | 62-64 | VESPAGS '62-64 USB/1 | MOTORE |
| ☆ 08853/A | PIAGGIO | | VESPA SS 180 | MOTORE SS 180 |
| 08856 | PIAGGIO | 60-62 | VESPA 125 | MOTORE E CARBURATORE |
| 08856 | PIAGGIO | 61-62 | VESPA 150 | MOTORE E CARBURATORE |
| 08865 | PIAGGIO | | VESPA 50-90-125 PRIMAVERA | MOTORE |
| 08865 | PIAGGIO | | VESPA 125 ET3 | MOTORE |
| 08865 | PIAGGIO | | APE 50 | MOTORE |
| 08865/A | PIAGGIO | | VESPA 125 PRIMAVERA | MOTORE |
| 08865/B | PIAGGIO | | VESPA 50-90-125 PRIMAVERA-ET3 (Senza O.R.) | MOTORE |
| ☆ 08883 | PIAGGIO | | CIAO 2ª SERIE | MOTORE |
| 09865 | PIAGGIO | 59-64 | VESPA 150 SPRINT-GL | MOTORE |
| 09866 | PIAGGIO | 66 | VESPA 150 | MOTORE |
| 10867 | PIAGGIO | | MOTORE CIAO-BOXER BRAVO MONOMARCIA SENZA VARIATORE | MOTORE |
| 10868 | PIAGGIO | | CIAO-BOXER BRAVO MONOMARCIA CON VARIATORE | MOTORE |
| 10876 | PIAGGIO | > 83 | PX -125 TS SENZA O.R. | MOTORE |
| 10876/A | PIAGGIO | 83 > | VESPA PX | MOTORE |
| 10877 | PIAGGIO | > 83 | PX FINO ALL'83-125 TS CON O.R. | MOTORE |
| 10877 | PIAGGIO | | VESPA 125 TS (CON OR) | MOTORE |
| 10895 | PIAGGIO | | APE P 602 TM - P 703 M | MOTORE |
| 11858 | PIAGGIO | | APE P 601 LS - CAR LS2 P2 SOLO MOTORE | MOTORE |
| 11867 | PIAGGIO | 87 > | VESPA PX | MOTORE |
| 11867 | PIAGGIO | 87 > | VESPA T5 | MOTORE |
| 11867 | PIAGGIO | 87 > | COSA | MOTORE |
| 11872 | PIAGGIO | | VESPA PX 50 XL | MOTORE |
| 11872 | PIAGGIO | | VESPA PX 50 FL2 | MOTORE |
| 11872 | PIAGGIO | | VESPA HP 4 M | MOTORE |
| 11872 | PIAGGIO | | APE 50 TMP | MOTORE |
| 11872/B | PIAGGIO | | VESPA PK 50 - XL - FL2 | MOTORE |
| 11881 | PIAGGIO | | GRILLO CON VARIATORE | MOTORE |
| 11883 | PIAGGIO | | GRILLO MONOMARCIA | MOTORE |

| Old Codice | Marca | Anno | Modello | Applicazione |
|------------|----------|-------|--|--------------|
| 11886 | PIAGGIO | | APE P 501 | MOTORE |
| ★ 11886 | PIAGGIO | 85 > | APE P601 2ª SERIE | MOTORE |
| 11891 | PIAGGIO | 97 | SFERA 50 RST - RESTYLING | MOTORE |
| 11891 | PIAGGIO | > 99 | FREE BUSINESS - LUSO - PIGMENTATO | MOTORE |
| 11891 | PIAGGIO | 96 > | NRG | MOTORE |
| 11891 | PIAGGIO | 95-98 | NTT | MOTORE |
| 11891 | PIAGGIO | > 96 | QUARTZ | MOTORE |
| 11891 | PIAGGIO | 97 | SFERA 50 RST - RESTYLING | MOTORE |
| 11891 | PIAGGIO | | SFERA 75 | MOTORE |
| 11891 | PIAGGIO | | SFERA 80 | MOTORE |
| 11891 | PIAGGIO | 97-99 | VESPA 50 ET 2 - ET 2 INJECTION | MOTORE |
| 11891 | PIAGGIO | > 99 | ZIP | MOTORE |
| 11891 | PIAGGIO | > 97 | ZIP FAST RIDER | MOTORE |
| 11891/AE | PIAGGIO | | MOTORE (PREZZO ECONOMICO) | MOTORE |
| 12852 | PIAGGIO | | SCOOTER PIAGGIO TUTTI I MODELLI RAFFREDDATI A LIQUIDO | MOTORE |
| 12852/AE | PIAGGIO | | TIPO ECONOMICO SCOOTERS PIAGGIO RAFFREDDATI A LIQUIDO | MOTORE |
| 12854 | PIAGGIO | 97 > | LIBERTY 50 | MOTORE |
| 12855 | PIAGGIO | 95 > | HEXAGON 125 LX | MOTORE |
| 12855 | PIAGGIO | > 97 | HEXAGON 150 | MOTORE |
| 12856 | PIAGGIO | 96-97 | SFERA RST 125 4 T | MOTORE |
| 12856 | PIAGGIO | 96-99 | VESPA ET4 125 | MOTORE |
| 12856 | PIAGGIO | > 99 | VESPA PX 125 | MOTORE |
| 12860 | PIAGGIO | | ALBERO MOTORE SCOTER 50 (solo 2 pezzi) | MOTORE |
| 11850 | PUCH | | COBRA | MOTORE |
| 11851 | PUCH | | 50 CC. TUTTI I MODELLI DAL 1979 | MOTORE |
| 12851 | SPEEDWAY | | MOTORE GM DA SPEEDWAY | MOTORE |
| 12850 | SUZUKI | | ADDRESS AH 50 - RF 50 | MOTORE |
| 12850 | SUZUKI | > 98 | AJ 50 ZZ | MOTORE |
| 12850 | SUZUKI | 95-98 | AP 50 | MOTORE |
| 12850 | SUZUKI | 99 > | AY 50 - W - WR - WRX | MOTORE |
| 12850 | SUZUKI | 97-98 | KATANA 50 - R 50 | MOTORE |
| 11878 | YAMAHA | | YAMAHA XT 600 | MOTORE |
| 11895 | YAMAHA | 99 > | BW'S BUMP | MOTORE |
| 11895 | YAMAHA | 97-99 | BW'S NG ORIGINAL | MOTORE |
| 11895 | YAMAHA | 95 > | BW'S SPY | MOTORE |
| 11895 | YAMAHA | > 96 | CT 50 SS | MOTORE |
| 11895 | YAMAHA | | ZUMA | MOTORE |
| 11896 | YAMAHA | | JOG 50 R | MOTORE |
| 11896 | YAMAHA | 95-97 | JOG Z | MOTORE |
| 11896 | YAMAHA | 97 > | NEO'S 50 | MOTORE |
| 12853 | YAMAHA | 97 > | AEROX 50 LC | MOTORE |



XNBR

Kits paraolio forcella

Il perfetto funzionamento della forcella anteriore è di fondamentale importanza per qualsiasi tipologia di moto, dal Superbike al Trial.

Ariete ha messo a punto una speciale formulazione di gomma XNBR resistente all'aggressione chimica provocata dagli additivi contenuti negli olii usati nelle forcelle.

È stata inoltre studiata una particolare forma dell'Anello Paraolio che con più labbri di tenuta, rettificati perfettamente, ripartisce e contiene in modo omogeneo la spinta dell'olio impedendo qualsiasi fuoriuscita. La linea di questi kits denominata Ari è

composta da oltre 160 misure diverse che equipaggiano più di 30.000 modelli di moto dagli anni 60 ad oggi. Ogni

Kit composto da due anelli di tenuta è dotato di una bustina dello speciale grasso ARISIL studiato e prodotto in USA per le applicazioni gomma-metallo

che migliorando il lavoro a cui è sottoposto il paraolio

ne aumentano la durata nel tempo.

RICHIEDETE IL CATALOGO SPECIFICO.





O-RING ARIETE

Gli anelli O-RING Ariete sono realizzati con una mescola NBR di durezza 70 Shore A che risponde alle seguenti Norme internazionali:

ASTM D 2000 - SAE J 200 - M2 BG 710 - A14 - B14 - EA14 - EF11 - EF21 - EO14 - EO34 - F15.

Controllo finale secondo AQL 1.

Tolleranze dimensionali DIN 3771/ISO 601

Scatola O-RING - Cod. 10934

$\varnothing 3,69 \Rightarrow \varnothing 18,64$

| Codice | \varnothing int. | \varnothing corda | Q.ta |
|--------|--------------------|---------------------|------|
| 00301 | 3,68 | 1,78 | 25 |
| 00303 | 4,48 | 1,78 | 25 |
| 00304 | 4,90 | 1,90 | 25 |
| 00308 | 6,07 | 1,78 | 25 |
| 00310 | 6,75 | 1,78 | 25 |
| 00312 | 7,66 | 1,78 | 25 |
| 00314 | 8,73 | 1,78 | 25 |
| 00318 | 9,13 | 2,62 | 25 |
| 00319 | 9,25 | 1,78 | 25 |
| 00320 | 9,19 | 2,62 | 25 |
| 00322 | 9,92 | 2,62 | 25 |
| 00324 | 10,78 | 2,62 | 25 |
| 00327 | 11,11 | 1,78 | 25 |
| 00330 | 11,91 | 2,62 | 25 |
| 00332 | 12,37 | 2,62 | 25 |
| 00336 | 13,10 | 2,62 | 25 |
| 00339 | 13,95 | 2,62 | 25 |
| 00341 | 15,08 | 2,62 | 25 |
| 00343 | 15,54 | 2,62 | 25 |
| 00346 | 15,88 | 2,62 | 25 |
| 00349 | 17,13 | 2,62 | 25 |
| 00351 | 17,86 | 2,62 | 25 |
| 00355 | 18,72 | 2,62 | 25 |
| 00356 | 18,64 | 3,53 | 25 |

Scatola O-RING - Cod. 10935

$\varnothing 20,22 \Rightarrow \varnothing 46,04$

| Codice | \varnothing int. | \varnothing corda | Q.ta |
|--------|--------------------|---------------------|------|
| 00359 | 20,22 | 3,53 | 20 |
| 00360 | 20,24 | 2,62 | 20 |
| 00362 | 20,63 | 2,62 | 20 |
| 00364 | 21,82 | 3,53 | 20 |
| 00367 | 22,22 | 2,62 | 20 |
| 00369 | 23,40 | 3,53 | 20 |
| 00372 | 23,81 | 2,62 | 20 |
| 00374 | 24,99 | 3,53 | 15 |
| 00377 | 25,80 | 3,53 | 15 |
| 00379 | 26,58 | 3,53 | 15 |
| 00383 | 28,17 | 3,53 | 15 |
| 00392 | 31,34 | 3,53 | 15 |
| 00397 | 32,93 | 3,53 | 15 |
| 01302 | 34,52 | 3,53 | 15 |
| 01306 | 36,10 | 3,53 | 15 |
| 01309 | 37,47 | 5,34 | 8 |
| 01310 | 37,69 | 3,53 | 15 |
| 01315 | 39,69 | 3,53 | 15 |
| 01316 | 40,65 | 5,34 | 8 |
| 01320 | 41,28 | 3,53 | 15 |
| 01322 | 42,86 | 3,53 | 15 |
| 01324 | 43,82 | 5,34 | 7 |
| 01328 | 44,45 | 3,53 | 10 |
| 01330 | 46,04 | 3,53 | 10 |

| Codice | Rif. Comm.Inglese | | Dimensioni | | Codice | Rif. Comm.Inglese | | Dimensioni | |
|--------|-------------------|------------|------------|---------|--------|-------------------|------------|------------|---------|
| | Attuale | Precedente | ø Int. | ø Corda | | Attuale | Precedente | ø Int. | ø Corda |
| 00301 | 2015 | 102 | 3,68 | 1,78 | 00345 | | | 15,70 | 1,30 |
| 00302 | | | 4,20 | 1,90 | 00346 | 121 | 121 | 15,88 | 2,62 |
| 00303 | 2018 | 103 | 4,48 | 1,78 | 00347 | | | 15,90 | 3,00 |
| 00304 | | | 4,90 | 1,90 | 00348 | | | 16,90 | 2,70 |
| 00305 | 2021 | 104 | 5,28 | 1,78 | 00349 | 3068 | 122 | 17,13 | 2,62 |
| 00306 | | | 5,70 | 1,90 | 00350 | 2068 | 123 | 17,17 | 1,78 |
| 00307 | | | 6,00 | 2,00 | 00351 | 123 | 123 | 17,86 | 2,62 |
| 00308 | 2025 | 105 | 6,07 | 1,78 | 00352 | | | 18,30 | 3,00 |
| 00309 | | | 6,40 | 1,90 | 00353 | | | 18,40 | 2,70 |
| 00310 | 106 | 106 | 6,75 | 1,78 | 00354 | | | 18,30 | 3,60 |
| 00311 | | | 7,20 | 1,90 | 00355 | 3075 | 124 | 18,72 | 2,62 |
| 00312 | 2031 | 107 | 7,66 | 1,78 | 00356 | 4075 | 125 | 18,64 | 3,53 |
| 00313 | | | 8,00 | 1,90 | 00357 | 2075 | | 18,77 | 1,78 |
| 00314 | 108 | 108 | 8,73 | 1,78 | 00358 | | | 19,80 | 3,60 |
| 00316 | | | 8,90 | 2,70 | 00359 | 4081 | 126 | 20,22 | 3,53 |
| 00317 | | | 9,00 | 2,00 | 00360 | 3081 | 127 | 20,24 | 2,62 |
| 00318 | 109 | 109 | 9,13 | 2,62 | 00361 | 2081 | | 20,35 | 1,78 |
| 00319 | 2037 | 110 | 9,25 | 1,78 | 00362 | 128 | 128 | 20,63 | 2,62 |
| 00320 | 3037 | 111 | 9,19 | 2,62 | 00363 | | | 21,30 | 3,60 |
| 00322 | 112 | 112 | 9,92 | 2,62 | 00364 | 4087 | 129 | 21,82 | 3,53 |
| 00323 | | | 10,50 | 2,70 | 00365 | 3087 | | 22,00 | 2,62 |
| 00324 | 3043 | 113 | 10,78 | 2,62 | 00366 | 2087 | | 21,95 | 1,78 |
| 00325 | 2043 | | 10,82 | 1,78 | 00367 | 130 | 130 | 22,22 | 2,62 |
| 00327 | 114 | 114 | 11,11 | 1,78 | 00368 | | | 23,00 | 3,60 |
| 00328 | | | 11,50 | 4,50 | 00369 | 4093 | 131 | 23,40 | 3,53 |
| 00329 | | | 11,60 | 2,60 | 00370 | 3093 | | 23,47 | 2,62 |
| 00330 | 115 | 115 | 11,91 | 2,62 | 00371 | 2093 | | 23,52 | 1,78 |
| 00332 | 3050 | 116 | 12,37 | 2,62 | 00372 | 132 | 132 | 23,81 | 2,62 |
| 00333 | 2050 | | 12,42 | 1,78 | 00373 | | | 24,60 | 3,60 |
| 00334 | | | 12,50 | 1,50 | 00374 | 4100 | 133 | 24,99 | 3,53 |
| 00335 | | | 13,00 | 1,60 | 00375 | 3100 | | 25,07 | 2,62 |
| 00336 | 117 | 117 | 13,10 | 2,62 | 00376 | 2100 | | 24,12 | 1,78 |
| 00337 | | | 13,60 | 2,70 | 00377 | 134 | 134 | 25,80 | 3,53 |
| 00338 | | | 13,80 | 2,20 | 00378 | | | 26,20 | 3,60 |
| 00339 | 3056 | 118 | 13,95 | 2,62 | 00379 | 4106 | 135 | 26,58 | 3,53 |
| 00340 | 2056 | | 14,00 | 1,78 | 00380 | 3106 | | 26,65 | 2,62 |
| 00341 | 119 | 119 | 15,08 | 2,62 | 00381 | 2106 | | 26,70 | 1,78 |
| 00342 | | | 15,10 | 2,70 | 00382 | | | 27,80 | 3,60 |
| 00343 | 3062 | 120 | 15,54 | 2,62 | 00383 | 4112 | 136 | 28,17 | 3,53 |
| 00344 | 2062 | | 15,60 | 1,78 | 00384 | 3112 | | 28,25 | 2,62 |

| Codice | Rif. Comm.Inglese | | Dimensioni | |
|--------|-------------------|------------|------------|---------|
| | Attuale | Precedente | ø Int. | ø Corda |
| 00385 | 2112 | | 28,30 | 1,78 |
| 00387 | | | 29,30 | 3,60 |
| 00388 | 4118 | | 29,75 | 3,53 |
| 00390 | 2118 | | 29,87 | 1,78 |
| 00391 | | | 30,80 | 3,60 |
| 00392 | 4125 | 138 | 31,34 | 3,53 |
| 00393 | 3125 | | 31,42 | 2,62 |
| 00394 | 2125 | | 31,47 | 1,78 |
| 00395 | | | 32,00 | 3,00 |
| 00396 | | | 32,50 | 3,60 |
| 00397 | 4131 | 139 | 32,93 | 3,53 |
| 00398 | 3131 | | 32,99 | 2,62 |
| 00399 | 2131 | | 33,05 | 1,78 |
| 01301 | | | 34,10 | 3,60 |
| 01302 | 4137 | 140 | 34,52 | 3,53 |
| 01303 | 3137 | | 34,60 | 2,62 |
| 01304 | 2137 | | 34,65 | 1,78 |
| 01305 | | | 35,60 | 3,60 |
| 01306 | 4143 | 141 | 36,10 | 3,53 |
| 01307 | 3143 | | 36,14 | 2,62 |
| 01309 | 6150 | 143 | 37,47 | 5,34 |
| 01310 | 4150 | 142 | 37,69 | 3,53 |
| 01311 | 3150 | | 37,77 | 2,62 |
| 01312 | | | 37,82 | 1,78 |

| Codice | Rif. Comm.Inglese | | Dimensioni | |
|--------|-------------------|------------|------------|---------|
| | Attuale | Precedente | ø Int. | ø Corda |
| 01314 | 3156 | | 39,34 | 2,62 |
| 01315 | 144 | 144 | 39,69 | 3,53 |
| 01316 | 6162 | 145 | 40,65 | 5,34 |
| 01317 | 4162 | | 40,86 | 3,53 |
| 01318 | 3162 | | 40,95 | 2,62 |
| 01319 | | | 41,00 | 1,78 |
| 01320 | 146 | 146 | 41,28 | 3,53 |
| 01321 | 3168 | | 42,52 | 2,62 |
| 01322 | 147 | 147 | 42,86 | 3,53 |
| 01323 | | | 43,40 | 1,50 |
| 01324 | 6175 | 148 | 43,82 | 5,34 |
| 01325 | 4175 | | 44,04 | 3,53 |
| 01326 | 3175 | | 44,12 | 2,62 |
| 01327 | | | 44,17 | 1,78 |
| 01328 | 149 | 149 | 44,45 | 3,53 |
| 01329 | 3181 | | 45,69 | 2,62 |
| 01330 | 150 | 150 | 46,04 | 3,53 |
| 01331 | 6187 | 151 | 47,00 | 5,34 |
| 01332 | 4187 | | 47,22 | 3,53 |
| 01333 | 3187 | | 47,30 | 2,62 |
| 01334 | | | 47,35 | 1,78 |
| 01335 | 152 | 152 | 47,63 | 3,53 |
| 01336 | 3193 | | 48,89 | 2,62 |
| 01337 | | | 49,00 | 1,50 |
| 01338 | 153 | 153 | 49,21 | 3,53 |

| misura | codice | colore | confezione | note |
|----------|-------------------|------------------------|-----------------|---------------------------------|
| 1,5 x 4 | 11949/10 | Nero | 10 metri | Sfiato carburatore |
| | 11949/10-T | Trasparente | 10 metri | Sfiato carburatore |
| 2 x 5 | 03998/10 | Nero | 10 metri | Sfiato carburatore |
| | 03998/10-T | Trasparente | 10 metri | Sfiato carburatore |
| 3 x 6 | 03999/10 | Nero | 10 metri | Sfiato carburatore |
| | 03999/10-T | Trasparente | 10 metri | Sfiato carburatore |
| 4 x 7 | 01925-V | Verde trasparente | 100 metri | tipo economico |
| | 01925/10 | Nero | 10 metri | tipo economico |
| | 01925/10-V | Verde trasparente | 10 metri | tipo economico |
| | 01925/10-S | Viola coestruso | 10 metri | per benzina senza piombo |
| 4,5 x 9 | 01958-V | Verde trasparente | 100 metri | tipo economico |
| | 01958/10 | Nero | 10 metri | tipo economico |
| | 01958/10-V | Verde trasparente | 10 metri | tipo economico |
| 4,8 x 9 | 11922/10-S | Viola coestruso | 10 metri | per benzina senza piombo |
| 5 x 8 | 01922 | Nero | 100 metri | tipo economico |
| | 01922-V | Verde trasparente | 100 metri | tipo economico |
| | 01922/10 | Nero | 10 metri | tipo economico |
| | 01922/10-V | Verde trasparente | 10 metri | tipo economico |
| 5,5 x 10 | 03904/10 | Nero | 10 metri | tipo economico |
| | 03904/10-S | Viola coestruso | 10 metri | per benzina senza piombo |
| | 03904/10-V | Verde trasparente | 10 metri | tipo economico |
| 6 x 9 | 01958/A | Nero | 100 metri | tipo economico |
| | 01958/A-10G | Antracite Polarlys | 10 metri | tipo intermedio |
| | 01958/A-V | Verde trasparente | 100 metri | tipo economico |
| | 01958/A/10 | Nero | 10 metri | tipo economico |
| | 01958/A10V | Verde trasparente | 10 metri | tipo economico |
| | 01958/A10S | Viola coestruso | 10 metri | per benzina senza piombo |
| | 09970/5 | Argento coestruso | 5 metri | tipo intermedio |
| 6,5 x 11 | 11923/10-S | Viola coestruso | 10 metri | per benzina senza piombo |
| 6 x 13 | 01902-V | Verde trasparente | 50 metri | tipo economico |
| | 01902/10 | Nero | 10 metri | tipo economico |
| | 01902/10-V | Verde trasparente | 10 metri | tipo economico |
| 7 x 10 | 01922/A | Nero | 100 metri | tipo economico |
| | 01922/A-V | Verde trasparente | 100 metri | tipo economico |
| | 01922/A/10 | Nero | 10 metri | tipo economico |
| | 01922/A10V | Verde trasparente | 10 metri | tipo economico |
| 8 x 13 | 11932/10-V | Verde trasparente | 10 metri | tipo economico |
| 10 x 15 | 11934/10-V | Verde trasparente | 10 metri | tipo economico |

Tubetto raccordo pompa freno-serbatoio liquido DOT4

| | | | | |
|-------------|---------|------|---------|------------------|
| 6x10 | 12978/5 | Nero | 5 metri | per liquido DOT4 |
|-------------|---------|------|---------|------------------|



are the trademarks of

SANDRO MENTASTI S.R.L.

Via Giovanni Macchi, 30 - Tel. +39 0332 310100 - Fax +39 0332 312632
21100 Varese - Italy

Copyright©
Sandro Mentasti s.r.l.

www.ariete.com - www.mentasti.com - www.oldmodels.it - info@ariete.com

Tutti i diritti riservati. Nessuna parte di questo catalogo può essere riprodotta o utilizzata in alcuna forma o con qualsiasi mezzo, elettronico o meccanico, compresa la fotocopiatura, la registrazione o qualsiasi altro sistema per archiviare o trattenere delle informazioni senza il permesso scritto da parte della Sandro Mentasti S.r.L.

SMQM CODE

| | | | |
|-----|----|----|----|
| CRI | IT | 01 | 14 |
|-----|----|----|----|

